



## 8 x 8 HDMI Matrix Switch

Switch (8) HDMI source devices plus IR to (8) HDMI displays.

Supports 1080p 3D HDMI or DVI formats + IR with RS-232 or IR remote control.



**Customer  
Support  
Information**

Order toll-free in the U.S.: Call 877-877-BBOX (outside U.S. call 724-746-5500)  
FREE technical support 24 hours a day, 7 days a week: Call 724-746-5500 or fax 724-746-0746  
Mailing address: Black Box Corporation, 1000 Park Drive, Lawrence, PA 15055-1018  
Web site: [www.blackbox.com](http://www.blackbox.com) • E-mail: [info@blackbox.com](mailto:info@blackbox.com)

## Trademarks Used in this Manual

---

### Trademarks Used in this Manual

Black Box and the Double Diamond logo are registered trademarks of BB Technologies, Inc.

Any other trademarks mentioned in this manual are acknowledged to be the property of the trademark owners.

Blu-ray is a trademark of the Blu-ray Disc Association.

HDMI is a registered trademark of HDMI Licensing L.L.C.

Xbox and Windows are registered trademarks of Microsoft Corporation.

We're here to help! If you have any questions about your application or our products, contact Black Box Tech Support at **724-746-5500** or go to **blackbox.com** and click on "Talk to Black Box." You'll be live with one of our technical experts in less than 30 seconds.

### Federal Communications Commission and Industry Canada Radio Frequency Interference Statements

This equipment generates, uses, and can radiate radio-frequency energy, and if not installed and used properly, that is, in strict accordance with the manufacturer's instructions, may cause interference to radio communication. It has been tested and found to comply with the limits for a Class A computing device in accordance with the specifications in Subpart B of Part 15 of FCC rules, which are designed to provide reasonable protection against such interference when the equipment is operated in a commercial environment. Operation of this equipment in a residential area is likely to cause interference, in which case the user at his own expense will be required to take whatever measures may be necessary to correct the interference.

Changes or modifications not expressly approved by the party responsible for compliance could void the user's authority to operate the equipment.

This digital apparatus does not exceed the Class A limits for radio noise emission from digital apparatus set out in the Radio Interference Regulation of Industry Canada.

Le présent appareil numérique n'émet pas de bruits radioélectriques dépassant les limites applicables aux appareils numériques de la classe A prescrites dans le Règlement sur le brouillage radioélectrique publié par Industrie Canada.

## Instrucciones de Seguridad (Normas Oficiales Mexicanas Electrical Safety Statement)

1. Todas las instrucciones de seguridad y operación deberán ser leídas antes de que el aparato eléctrico sea operado.
2. Las instrucciones de seguridad y operación deberán ser guardadas para referencia futura.
3. Todas las advertencias en el aparato eléctrico y en sus instrucciones de operación deben ser respetadas.
4. Todas las instrucciones de operación y uso deben ser seguidas.
5. El aparato eléctrico no deberá ser usado cerca del agua—por ejemplo, cerca de la tina de baño, lavabo, sótano mojado o cerca de una alberca, etc.
6. El aparato eléctrico debe ser usado únicamente con carritos o pedestales que sean recomendados por el fabricante.
7. El aparato eléctrico debe ser montado a la pared o al techo sólo como sea recomendado por el fabricante.
8. Servicio—El usuario no debe intentar dar servicio al equipo eléctrico más allá a lo descrito en las instrucciones de operación. Todo otro servicio deberá ser referido a personal de servicio calificado.
9. El aparato eléctrico debe ser situado de tal manera que su posición no interfiera su uso. La colocación del aparato eléctrico sobre una cama, sofá, alfombra o superficie similar puede bloquea la ventilación, no se debe colocar en libreros o gabinetes que impidan el flujo de aire por los orificios de ventilación.
10. El equipo eléctrico debe ser situado fuera del alcance de fuentes de calor como radiadores, registros de calor, estufas u otros aparatos (incluyendo amplificadores) que producen calor.
11. El aparato eléctrico deberá ser conectado a una fuente de poder sólo del tipo descrito en el instructivo de operación, o como se indique en el aparato.
12. Precaución debe ser tomada de tal manera que la tierra física y la polarización del equipo no sea eliminada.
13. Los cables de la fuente de poder deben ser guiados de tal manera que no sean pisados ni pellizcados por objetos colocados sobre o contra ellos, poniendo particular atención a los contactos y receptáculos donde salen del aparato.
14. El equipo eléctrico debe ser limpiado únicamente de acuerdo a las recomendaciones del fabricante.
15. En caso de existir, una antena externa deberá ser localizada lejos de las líneas de energía.
16. El cable de corriente deberá ser desconectado del cuando el equipo no sea usado por un largo periodo de tiempo.
17. Cuidado debe ser tomado de tal manera que objetos líquidos no sean derramados sobre la cubierta u orificios de ventilación.
18. Servicio por personal calificado deberá ser provisto cuando:
  - A: El cable de poder o el contacto ha sido dañado; u
  - B: Objetos han caído o líquido ha sido derramado dentro del aparato; o
  - C: El aparato ha sido expuesto a la lluvia; o
  - D: El aparato parece no operar normalmente o muestra un cambio en su desempeño; o
  - E: El aparato ha sido tirado o su cubierta ha sido dañada.

### Safety Information

*NOTE: THIS SAFETY INFORMATION IS OF A GENERAL NATURE AND MAY BE SUPERSEDED BY INSTRUCTIONS CONTAINED WITHIN THIS MANUAL.*

1. Save the carton and packing material even if the equipment has arrived in good condition. If you ever need to ship the unit, use only the original factory packing.
2. Read all documentation before operating your equipment. Retain all documentation for future reference.
3. Follow all instructions printed on unit chassis for proper operation.
4. Do not spill water or other liquids into or on the unit, or operate the unit while standing in liquid.
5. Make sure power outlets conform to the power requirements listed on the back of the unit.
6. Do not use the unit if the electrical power cord is frayed or broken. The power supply cords should be routed so that they are not likely to be walked on or pinched by items placed upon or against them, paying particular attention to cords and plugs, convenience receptacles, and the point where they exit.
7. Always operate the unit with the AC ground wire connected to the electrical system ground. Precautions should be taken so that the means of grounding of a piece of equipment is not defeated.
8. Voltage must be correct and the same as that printed on the rear of the unit. Damage caused by connection to improper AC voltage is not covered by any warranty.
9. Power down and disconnect the unit from mains voltage before making connections.
10. Never hold a power switch in the "ON" position.
11. Do not use the unit near stoves, heat registers, radiators, or other heat-producing devices.
12. Do not block fan intake or exhaust ports. Do not operate equipment on a surface or in an environment which may impede the normal flow of air around the unit, such as a bed, rug, carpet, or completely enclosed rack. If the unit is used in an extremely dusty or smoky environment, the unit should be periodically "blown free" of foreign matter.
13. Do not remove the cover. Removing the cover will expose you to potentially dangerous voltages. There are no user serviceable parts inside.
14. Do not drive the inputs with a signal level greater than that required to drive equipment to full output.
15. Non-use periods. The power cord of equipment should be unplugged from the outlet when left unused for a long period of time.
16. Service information equipment should be serviced by qualified service personnel when:
  - A. The power supply cord or the plug has been damaged.
  - B. Objects have fallen, or liquid has been spilled into the equipment.
  - C. The equipment has been exposed to rain.
  - D. The equipment does not appear to operate normally, or exhibits a marked change in performance
  - E. The equipment has been dropped, or the enclosure damaged.

# Important Safety Instructions

---

## IMPORTANT SAFETY INSTRUCTIONS

To get the best from this product, please read this manual carefully. Keep it in a safe place for future reference.

To reduce the risk of electric shock, do not remove the cover from the unit. No user serviceable parts inside. Refer servicing to qualified personnel.

To reduce the risk of fire, do not expose the unit to rain, water or excessive moisture.

Do not force switched or external connections.

When moving the unit disconnect the serial port connections first then the power cable and finally the interconnecting cables to other devices.

Do not attempt to clean the unit with chemical solvents or aerosol cleaners, as this may damage the unit. Use a clean dry cloth.

Installation of this unit should be in a cool dry place, away from sources of excessive heat, vibration, dust, moisture and cold.

*WARNING: To prevent electric shock do not use this (polarized) plug with an extension cord, receptacle or other outlet unless the blades can be fully inserted to prevent blade exposure. To prevent electric shock, match wide blade of plug to wide slot, fully insert.*

*CAUTION: TO REDUCE THE RISK OF ELECTRIC SHOCK, DO NOT REMOVE COVER (OR BACK), NO USER SERVICEABLE PARTS INSIDE, REFER SERVICING TO QUALIFIED SERVICE PERSONNEL.*

*WARNING: TO REDUCE THE RISK OF FIRE OR ELECTRIC SHOCK, DO NOT EXPOSE THIS EQUIPMENT TO RAIN OR MOISTURE.*

Table of Contents

- 1. Specifications ..... 8
- 2. Overview ..... 9
  - 2.1 Introduction ..... 9
  - 2.2 Features ..... 9
  - 2.3 What’s Included ..... 9
  - 2.4 Hardware Description ..... 10
    - 2.4.1 Front Panel ..... 10
    - 2.4.2 Rear Panel ..... 11
- 3. Installation ..... 13
  - 3.1 Installation Diagram ..... 13
  - 3.2 IR Extender ..... 14
- 4. Operation ..... 15
  - 4.1 EDID Setup ..... 15
  - 4.2 Embedded EDID Modes ..... 15
  - 4.3 Copy EDID ..... 15
  - 4.4 EDID Status ..... 16
  - 4.5 How to Set Up Fast Speed Start (FSS) Function ..... 17
  - 4.6 Auto Mode Definition ..... 17
  - 4.7 Consumer Electronics Control (CEC) Setup ..... 17
  - 4.8 Front-Panel Control Functions ..... 18
  - 4.9 Remote Control ..... 18
  - 4.10 IR Remote Custom and Data Codes (NEC Standard) ..... 19
- 5. RS-232 Serial Interface ..... 20
- 6. Troubleshooting ..... 21
  - 6.1 Contacting Black Box ..... 21
  - 6.2 Shipping and Packaging ..... 21

# Chapter 1: Specifications

---

## 1. Specifications

**Controls** — IR remote control, IR external port with (1) 3.5-mm earphone jack, Select and Function buttons on front panel, RS-232 series interface

**Digital Audio Support** — Multi audio formats 5.1/7.1, MAT (MLP), Dolby Digital, Dolby TrueHD, Dolby Digital Plus, DTS, DTS-ES 6.1, DTS-HD, DTS-HD-HRA, DTS-HD Master, (PCM-2CH)

**Digital Video Support** — Full HD resolution: 480i, 480p, 720p, 1080i, 1080p

**Function Control Key** — ALL/OFF/RECALL/ENTER/MEMORY/LOCK/EDID

**HDCP/CEC Support** — HDCP 2.0 compliant, CEC compliant

**HDMI I/O Connector** — HDMI Type A, SMD 19-pin female

**HDMI Support** — HD 1080P @ 60 Hz, H36-bit deep color, 3D (1.4a) formats

**Infrared Frequency** — 38 kHz

**IR External Distance** — 1000 feet (300 m) maximum

**Preview Output** — Supports (1) preview output port simultaneously via output #1

**Safety Approvals** — CE, FCC, RoHS

**Source Status** — Automatically scan sources inputs via LED

**Temperature Tolerance** — Operating: +32 to +100° F (0 to +38° C)

**Video Bandwidth** — Double data rates: 340 MHz, total 6.75 Gbps bandwidth

**Power** — Input: 100–230 VAC, 50/60 Hz;  
Output: 12 VDC, 5 A;  
Consumption: 3880 mA maximum

**Size** — 1.75"H (1U) x 9.85"W x 19"D (4.4 x 25 x 48.2 cm)

**Weight** — 4.2 lb. (2.5 kg)



## 2. Overview

### 2.1 Introduction

The HDMI8X8 is a high-performance 8x8 matrix routing switch for HDMI signals. This switch supports data rates up to 6.75 Gbps, enabling 1080p HDMI formats and UXGA/WUXGA/DVI resolution to any HD display. High Definition Digital signals can be selected and distributed to any eight outputs simultaneously. The switch is certified as being fully HDMI® and HDCP compliant, with RoHS, CE, and FCC certification. It supports high-resolution HDMI sources routed to HDMI displays, monitors, projectors, or audio receivers. The EDID can be selected between seven different modes or copied from the attached displays. You can control the switch via front panel push buttons, IR remote, or RS-232.

### 2.2 Features

- Matrix switches (8) HDMI digital source devices to (8) HDMI devices.
- Supports HDMI digital video w/embedded audio, DVI format and complies with CEC/HDCP 2.0.
- Includes (7) function key controls.
- Supports worldwide EDID modes for HDTV resolutions.
- Enables link speeds of up to 6.75 Gbps (link clock rate of 340Mb Hz) and supports HDMI 1.4a 3D formats.
- Works with wide range of HD resolutions from PC XGA to WUXGA 1920x1200 and HDTV/DTV resolutions 480i/480p, 576i/576p, 720p, 1080i, and 1080p.
- Compatible with all HDMI source devices, PC monitors, plasma HD displays, HDTV and audio receivers/amplifiers.
- Provides digital video TMDS formats resolution up to 1080P-60 with Deep color 36-bit.
- Supports digital audio: Dolby TrueHD, Dolby Digital, Dolby Digital Plug/ex, DTS, DTS-HD, DTS-HD Master, DTS-EX, PCM, PCM2, LPCM2.
- Choose from three ways to control the user interface: front panel push button, IR wireless remote control, and third-party RS-232 controller (via simple ASCII).
- Supports world wide control functions: ALL/OFF/RECALL/ENTER/MEMORY/EDID/LOCK.
- Supports built-in EDID modes, external copy, and auto mode
- Front-panel LEDs show active input and output status.
- Supports preview output port simultaneously with output #1.
- Supports IR Remote and IR Extender with distance up to 1000 feet (300 m) maximum.
- Provides EDID configuration via Internal modes.
- Consumer Electronic Control (CEC) switch can be all open or OFF.
- Remembers the last state during a power cycle.
- When power is removed and resorted, the last configuration will be restored.

### 2.3 What's Included

Your package should include the following items. If anything is missing or damaged, contact Black Box Technical Support at 724-746-5500 or [info@blackbox.com](mailto:info@blackbox.com).

- Main console unit
- IR remote control
- IR extender receiver kit

# Chapter 2: Overview

- RS-232 cable
- 100–230 VAC, 12 VDC, 5A universal power supply
- 19-inch rackmount brackets
- User manual

## 2.4 Hardware Description

Figures 2-1 and 2-2 show the front panel of the switch, and Figure 2-3 shows its back panel. Tables 2-1 and 2-2 describe the components.

### 2.4.1 Front Panel

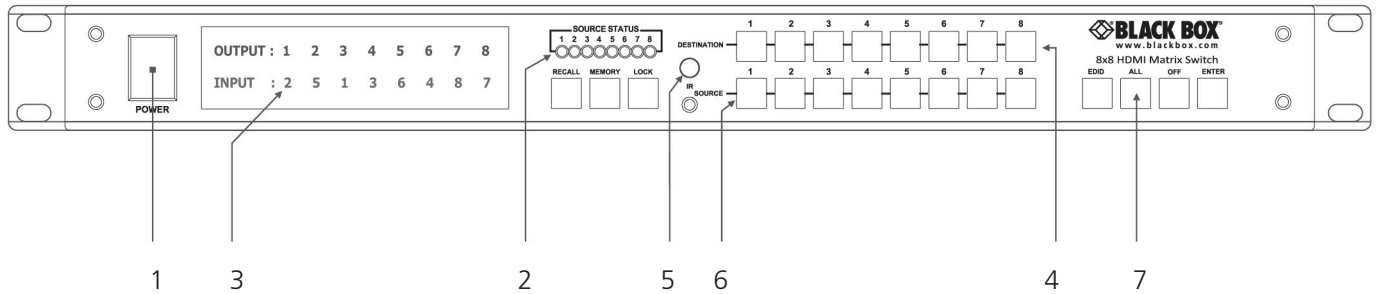

Figure 2-1. Front-panel diagram #1.

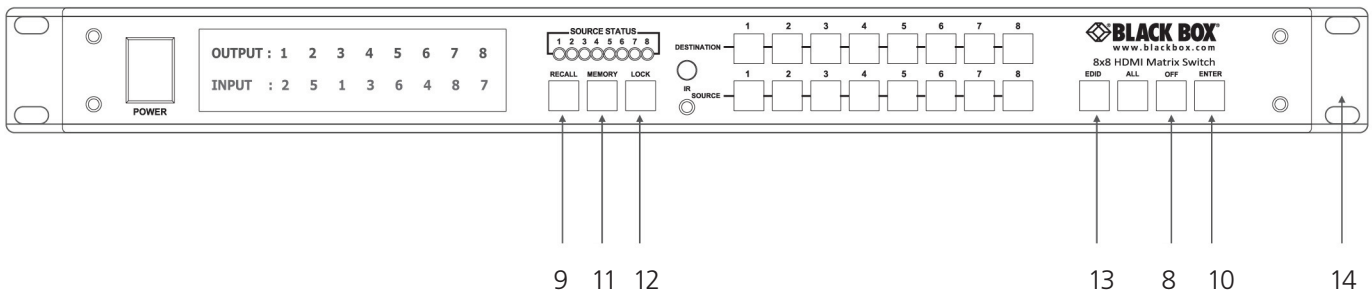

Figure 2-2. Front-panel diagram #2.

Table 2-1. Front-panel components.

Number	Component	Description
1	Power Switch	The power switch turns the unit on and off. The LED will light red to indicate that the switch is on and is receiving power. The switch will remember that last state during a power cycle. When power is removed and restored, the last configuration will be used.
2	Input Status Display	Input sources 1 to 8 LED lights blue to indicate that a video source is present on that input.
3	Output Status Display	Each output (destination) channel shows which input (source) is assigned.
4	Destination Select Buttons	Separate outputs 1 through 8 select buttons are provided for each destination assignment.
5	IR Sensor	The IR sensor receives IR commands from the supplied remote control or third-party emitter.
6	Function Key — ALL	Disables (mute) video on all destinations OR selects the same source to all destinations. Option 1: Press ALL followed by the OFF button. The display will show “0,” indicating that all destinations have no video selected. Option 2: Press ALL followed by Source 1 through 8. The display will show the source selected. Press ENTER and the preset source selection will be assigned to all destinations.
7	Source Select Buttons	Separate inputs 1 through 8 select buttons are provided for each source selection. Source buttons 1 and 2 are used to change EDID modes when the EDID button is pressed.

Table 2-1 (Continued). Front-panel components.

Number	Component	Description
8	Function Key — OFF	Disables (mutes) video to selected channels. <ul style="list-style-type: none"> <li>Press the OFF button followed by any destination channel.</li> <li>Press button 1 through 4 to select the output destination. The display will show "0" for the selected channel indicating no video selected.</li> </ul>
9	Function Key — RECALL (preview)	The system will show previously stored presets, up to a total of 16. Presets are stored in local memory using Source keys 1 through 8 or Destination keys 1 through 8 as the memory preset location. <ul style="list-style-type: none"> <li>Press the RECALL button.</li> <li>Press 1 through 4 on either Source or Destination row.</li> <li>Press ENTER. The preset configuration will execute. Operation completes.</li> </ul> <p><i>NOTE: Operation will abort if no keys are pressed within 5 seconds.</i></p>
10	Function Key—Enter (or DEMO)	Press ENTER to confirm entries.
11	Function Key—Memory (or SAVE)	The system will store presets, up to a total of 16. Presets are stored in local memory using Source keys 1 through 8 or Destination keys 1 through 8 as the memory preset location. <ul style="list-style-type: none"> <li>Configure desired matrices.</li> <li>Press the memory button.</li> <li>Press 1 through 4 on either Source or Destination row.</li> <li>Press ENTER to ready memory location.</li> <li>Or press MEMORY again to cancel operation. Operation completes.</li> </ul> <p><i>NOTE: Operation will abort if no keys are pressed within 5 seconds.</i></p>
12	Function Key — LOCK	<ul style="list-style-type: none"> <li>Press and hold the LOCK button for two seconds to lockout the front panel.</li> <li>Press and hold the LOCK button for two seconds to re-enable the front panel.</li> </ul>
13	Function Key — EDID	Press EDID to select new EDID mode and select source button #1 or #2 to change embedded EDID mode.
14	19" rackmount ears	Converts a desktop switch to a 19-inch rackmount switch. Brackets are included. Figure 2-2 shows rackmount bracket attached.

2.4.2 Rear Panel

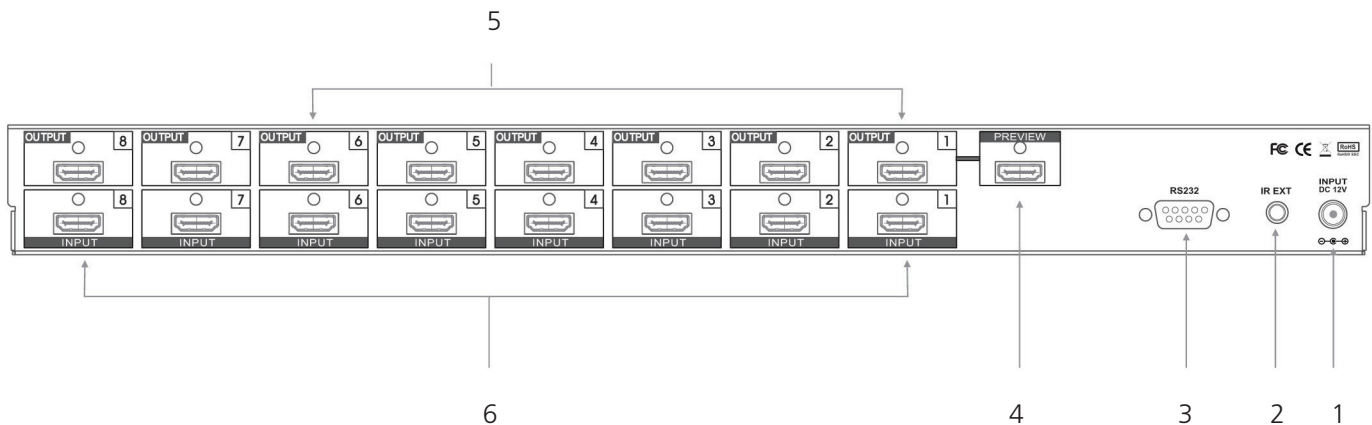
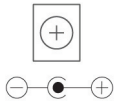

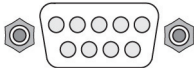
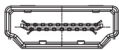
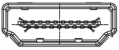
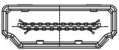

Figure 2-3. Rear panel.

Table 2-2. Rear-panel components.

Number	Component	Connector	Connector Description	Component Description
1	DC Power Inlet		Power jack: DC jack: inner OID 2.1-mm  Power input: 12 VDC, 5 A	Disables (mutes) video to selected channels. <ul style="list-style-type: none"> <li>• Press the OFF button followed by any destination channel.</li> <li>• Press button 1 through 4 to select the output destination. The display will show "0" for the selected channel indicating no video selected.</li> </ul>
2	IR Extender Control		IR extender jack: Female jack: inner OID 3.5-mm	Support one IR Extender. When you plug the external IR extender into the switch, the front panel IR receiver remains active.
3	RS-232 Connection		Remote port: DB9 female connector	RS-232 control port enables interfacing a PC, computer, or touch panel to the switch via the DB9 female connector for serial RS-232 control.
4	Preview Output-01 HDMI		HDMI digital video/audio connector: HDMI female connector.  <i>NOTE: With the proper adapters, you can use the switch with DVI digital video signals. HDCP compliant. DVI does not support audio.</i>	Connect a signal link of HDMI direct digital video/audio to this female HDMI connector. The connector supports HDMI digital video/audio and HDMI digital video sources.  Preview port HDMI signal is the same as Output 1.
5	Inputs — 1, 2, 3, 4, 5, 6, 7, 8 HDMI		HDMI digital video/audio connector: HDMI female connector.  <i>NOTE: With the proper adapters, you can use the switch with DVI digital video signals. HDCP compliant. DVI does not support audio.</i>	Connect a signal link of HDMI direct digital video/audio to this female HDMI connector. The connector supports HDMI digital video/audio and HDMI digital video sources.  HDMI Digital Video/Audio, connector with fixed screw Input 1–8
6	Outputs — 1, 2, 3, 4, 5, 6, 7, 8 HDMI		HDMI digital video/audio connector: HDMI female connector.  <i>NOTE: With the proper adapters, you can use the switch with DVI digital video signals. HDCP compliant. DVI does not support audio.</i>	Connect a signal link of HDMI direct digital video/audio to this female HDMI connector. The connector supports HDMI digital video/audio and HDMI digital videp sources.  HDMI Digital Video/Audio, connector with fixed screw Output 1–8

### 3. Installation

#### 3.1 Installation Diagram

Figure 3-1 shows a sample application using the 8x8 HDMI Matrix Switch.

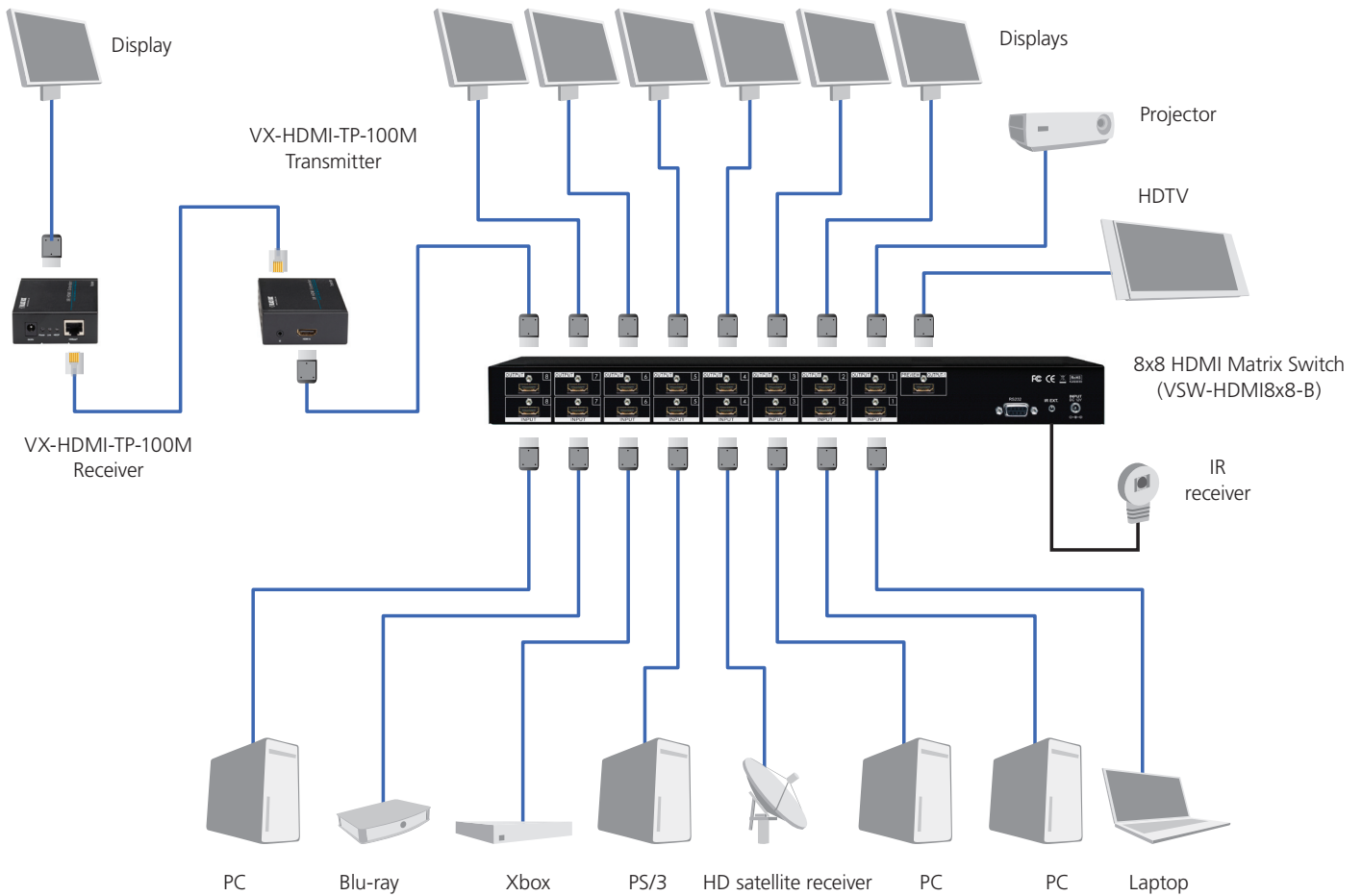

Figure 3-1. Typical application using the 8 x 8 HDMI Matrix Switch.

# Chapter 3: Installation

## 3.2 IR Extender

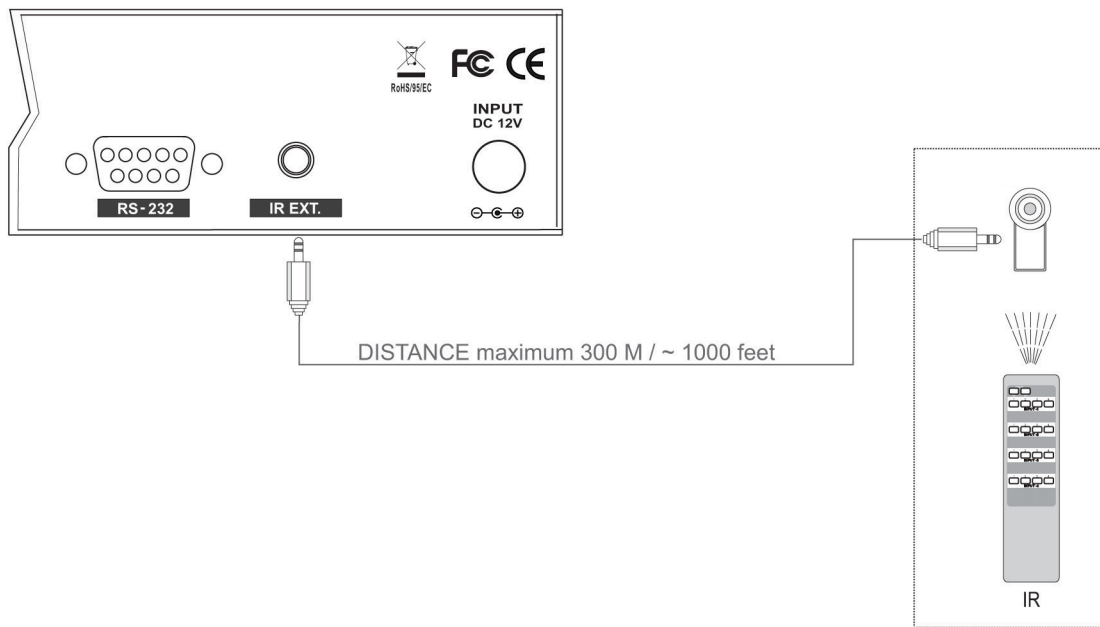

Figure 3-2. IR extender connection.

NOTE: When you plug the external IR extender into the switch, the front panel IR receiver remains active.

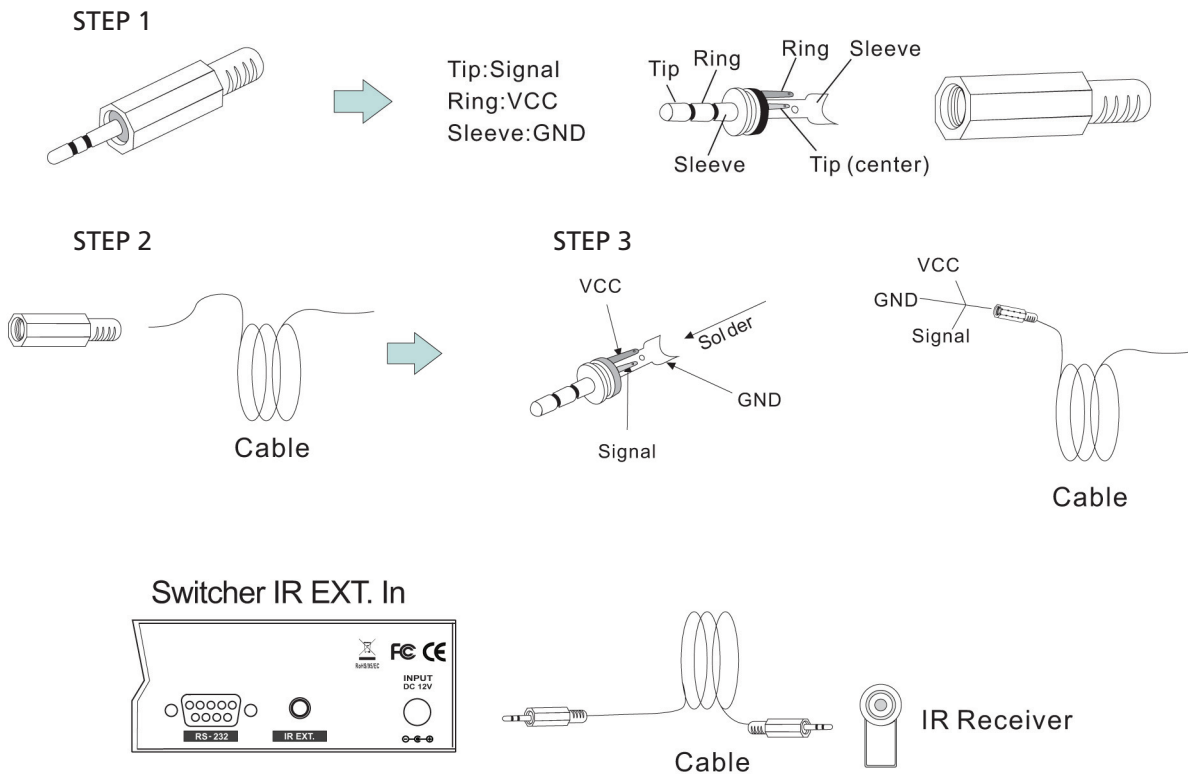

Figure 3-3. How to set up the IR extender components: Steps 1-3.

## 4. Operation

### 4.1 EDID Setup

Table 4-1. EDID function for HDMI matrix switch.

Step Number	Action	Result
Step 1	Press the EDID button	The display will show the currently selected EDID mode.
Step 2	Press the SOURCE #1 or #2 button row	The button will flash blue and the display will show the current Embedded EDID status.
Step 3	Press the ENTER button	To set EDID mode. The switch will return to operation mode.

### 4.2 Embedded EDID Modes

*NOTE: Does only work with HDMI displays. For use with DVI displays, see Section 4.3, Copy EDID.*

Press "EDID > Source > Enter" where source = Source #1 or #2. There are a total of 8 EDID modes:

Mode 1 FSS	Mode 5 H36M
Mode 2 H24-3D	Mode 6 1280 x 1024 DVI-D
Mode 3 H24M-3D	Mode 7 1920 x 1200 DVI-D
Mode 4 H36	Mode 8 AUTO

Table 4-2. Embedded EDID modes.

Mode Number	Embedded EDID Setup	Description
Mode 1	FSS (Fast Speed Start)	Automatically capture the most suitable EDID from Destination to Source.
Mode 2	H24-3D (1080p-24 bits)	Audio support: PCM 2CH
Mode 3	H24M-3D (1080p-24 bits)	Audio support: MAT (MLP) 7.1CH, PCM 2CH, one bit audio 2CH, AC-3 5.1CH, DTS 5.1CH, PCM 7.1CH, Dolby Digital +7.1CH, DTS-HD 7.1CH
Mode 4	H36 (1080p-36 bits)	Audio support: PCM 2CH
Mode 5	H36M (1080p-36 bits)	Audio support: MAT (MLP) 7.1CH, PCM 2CH, one bit audio 2CH, AC-3 5.1CH, DTS 5.1CH, PCM 7.1CH, Dolby Digital +7.1CH, DTS-HD 7.1CH
Mode 6	1280 x 1024 DVI-D	Frequency: 60 Hz
Mode 7	1920 x 1200 DVI-D	Frequency: 60 Hz
Mode 8	AUTO <Default>	All outputs will be set to the highest common resolution of all connected display devices.

### 4.3 Copy EDID

Press "EDID > Destination > Source > Enter." The switch will learn the destination EDID and pass the selected source.

*NOTE: The stored, copied EDID table will be static and not change unless you switch to one of the other EDID modes. It is not possible to copy from the same destination numerous times. To do a new copy from the same destination, you either have to first copy from another destination, or first select one of the embedded EDID modes.*

## Chapter 4: Operation

Table 4-3. Copy EDID to single input.

Step Number	Action	Result
Step 1	Press the EDID button	The button will flash blue and the display will show the current Embedded EDID Status.
Step 2	Press one of the Destination buttons #1-8	Copy EDID. from the selected destination.
Step 3	Press one of the source buttons #1-8	Copy to the Destination EDID to the selected source.
Step 4	Press the ENTER button	Confirm entries.

Table 4-4. Copy EDID to multiple inputs.

Step Number	Action	Result
Step 1	Press the EDID button	The button will flash blue and the display will show the current Embedded EDID Status.
Step 2	Press one of the Destination buttons #1-8	Copy EDID from the selected destination.
Step 3	Press to enable all the source buttons (#1-5) to which the EDID should be copied.	Copy the destination EDID to selected sources.
Step 4	Press the ENTER button	Confirm entries.

Table 4-5. Copy EDID to ALL inputs.

Step Number	Action	Result
Step 1	Press the EDID button	The button will flash blue and the display will show the current Embedded EDID Status.
Step 2	Press one of the Destination buttons #1-8	Copy EDID from selected destination.
Step 3	Press "All" button to select all sources	Copy the destination EDID to all sources.
Step 4	Press the ENTER button	Confirm entries.

### 4.4 EDID Status

Table 4-6. EDID status.

Step Number	Action	Result
Step 1	Press the EDID button	The button will flash blue and the display will show the current Embedded EDID Status.
Step 2	Press the EDID button	To exit.



## 4.5 How to Set Up Fast Speed Start (FSS) Function

Table 4-7. Setting up Fast Speed Start (FSS) function.

Step Number	Action	Result
Step 1	Press the Destination #1–8 button row, then press the Source #1–8 button row	To set up and install all devices.
Step 2	Press EDID button	Select an optimum status of Embedded EDID mode.
Step 3	Press the ENTER button	Confirm entries.
Step 4	Press the EDID button	Select the EDID FSS mode.
Step 5	Press the ENTER button	Confirm entries.

## 4.6 Auto Mode Definition

The switch will detect and automatically copy the EDID for the highest common supported video mode of the displays.

### Example for a single destination:

Destination device #1 will be set to the highest common audio and video mode supported by source #1.

### Example for multiple destinations:

The highest supported common audio and video mode for destination device #1, #2 and #3 will be copied to the active source.

## 4.7 Consumer Electronics Control (CEC) Setup

In brief, CEC allows HDMI devices to control each other when necessary and allows the user to operate multiple devices with one remote control handset.

### To enable CEC:

- Press EDID button.
- Press ALL button.
- Press EDID button. The pre-set configuration will execute.

### To disable CEC:

- Press EDID button
- Press OFF button
- Press EDID button The pre-set configuration will execute.

*NOTE: Not all devices support CEC. Check with your device's Users Guide for additional information and specifications. For stable operation, only connect HDMI connections with the switch powered OFF.*

# Chapter 4: Operation

## 4.8 Front-Panel Control Functions

See Chapter 2.

## 4.9 Remote Control

Before making any connections to the switch, observe the following:

- Make sure that the voltage supply matches the label on the supplied plug ( $\pm 10\%$ ).
- Make sure that the power switch is OFF.
- Make sure that all system grounds are connected to a common point.
- Avoid powering equipment with a system from multiple power sources that may be separated by large distances.
- Connect all audio video sources and destination equipment.
- Power on all source and destination audio-visual sources.
- For each destination output, select the appropriate input source by using the front-panel input 1–8 select buttons, the supplied IR remote control, or through the RS-232 serial communications port.
- Upon power up the switch will return to its last used setting before it was powered down.

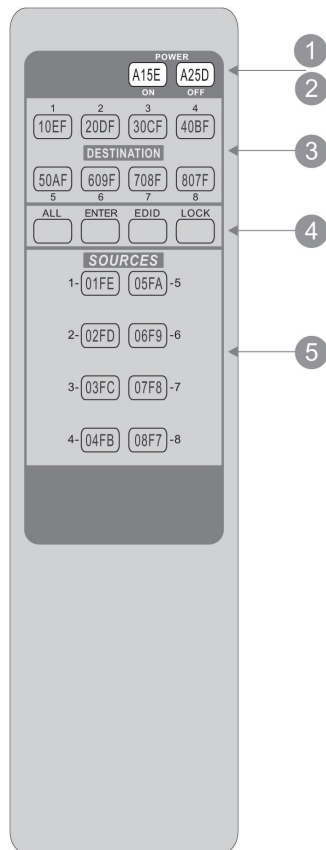

Table 4-8. IR Remote Control Key.

Number in Figure 4-1	Description
1	Switch Power ON
2	Switch Power OFF
3	Destination: 1–8 output selection: Press the destination button to select the output display channel.
4	Function Key: ALL: function selection button ENTER: function selection button EDID: function selection button LOCK: function selection button
5	Source: 1–8 input source selection: Press input 1–8 sources with selection button

Figure 4-1. IR remote.

## 4.10 IR Remote Custom and Data Codes (NEC Standard)

HOW TO SETUP IR CODES:

CUSTOM CODE: 09F6	ALL: 09F6 B04F
POWER ON: 09F6 A15E	ENTER: 09F6 B34C
POWER OFF: 09F6 A25D	EDID: 09F6 B748
	LOCK: 09F6 B54A

PRESS DESTINATION # then PRESS SOURCE #

DESTINATION #1:	09F6 10EF	SOURCE #1 :	09F6 01FE
DESTINATION #2:	09F6 20DF	SOURCE #2 :	09F6 02FD
DESTINATION #3:	09F6 30CF	SOURCE #3 :	09F6 03FC
DESTINATION #4:	09F6 40BF	SOURCE #4 :	09F6 04FB
DESTINATION #5:	09F6 50AF	SOURCE #5 :	09F6 05FA
DESTINATION #6:	09F6 609F	SOURCE #6 :	09F6 06F9
DESTINATION #7:	09F6 708F	SOURCE #7 :	09F6 07F8
DESTINATION #8:	09F6 807F	SOURCE #8 :	09F6 08F7

For example:

Select Destination # 1 to show Source #1~8,

The IR Data Code list:

Press Destination #1, Source #1	009F6	10EF	09F6	01FE
Press Destination #1, Source #2	09F6	10EF	09F6	02FD
Press Destination #1, Source #3	09F6	10EF	09F6	03FC
Press Destination #1, Source #4	09F6	10EF	09F6	04FB
Press Destination #1, Source #5	09F6	10EF	09F6	05FA
Press Destination #1, Source #6	09F6	10EF	09F6	06F9
Press Destination #1, Source #7	09F6	10EF	09F6	07F8
Press Destination #1, Source #8	09F6	10EF	09F6	08F7

# Chapter 5: RS-232 Serial Interface

## 5. RS-232 Serial Interface

RS-232 SERIAL INTERFACE CONNECT A PC OR CONTROL SYSTEM. VERSION COMPATIBLE V2.0

For a complete list of commands, refer to the extended RS-232 Protocol Instruction Manual.

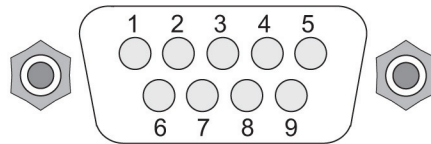

Figure 5-1. RS-232 DB9 connector.

Table 5-1. RS-232 serial interface pinouts.

Pin	RS-232	Defintion
1	----	Not used
2	TX	Transmitter
3	RX	Receiver
4	----	Not used
5	GND	Ground
6	----	Not used
7	----	Not used
8	-----	Not used
9	----	Not used

### RS-232 PROTOCOL COMMANDS

You can control the switch via the RS-232 serial control port to interface to a PC or similar third-party control system.

The serial communication parameters are 9600 baud, 8 bit, No Parity, and 1 stop bit. This is often referred to as 9600 8N1. When the unit recognizes a complete command, it will perform the requested action. There is no delimiter character required.

0 = the number

O = the letter

### 6. Troubleshooting

#### 6.1 Contacting Black Box

If you determine that your 8X8 HDMI Matrix Switch is malfunctioning, do not attempt to alter or repair the unit. It contains no user-serviceable parts. Contact Black Box Technical Support at 724-746-5500 or [info@blackbox.com](mailto:info@blackbox.com).

Before you do, make a record of the history of the problem. We will be able to provide more efficient and accurate assistance if you have a complete description, including:

- the nature and duration of the problem.
- when the problem occurs.
- the components involved in the problem.
- any particular application that, when used, appears to create the problem or make it worse.

#### 6.2 Shipping and Packaging

If you need to transport or ship your 8X8 HDMI Matrix Switch:

- Package it carefully. We recommend that you use the original container.
- If you are returning the unit, make sure you include everything you received with it. Before you ship for return or repair, contact Black Box to get a Return Authorization (RA) number.





**Black Box Tech Support: FREE! Live. 24/7.**

Tech support the  
way it should be.



Great tech support is just 30 seconds away at 724-746-5500 or [blackbox.com](http://blackbox.com).



### About Black Box

Black Box provides an extensive range of networking and infrastructure products. You'll find everything from cabinets and racks and power and surge protection products to media converters and Ethernet switches all supported by free, live 24/7 Tech support available in 30 seconds or less.

© Copyright 2012. Black Box Corporation. All rights reserved.

VSW-HDMI8X8-B, version 2

724-746-5500 | [blackbox.com](http://blackbox.com)