

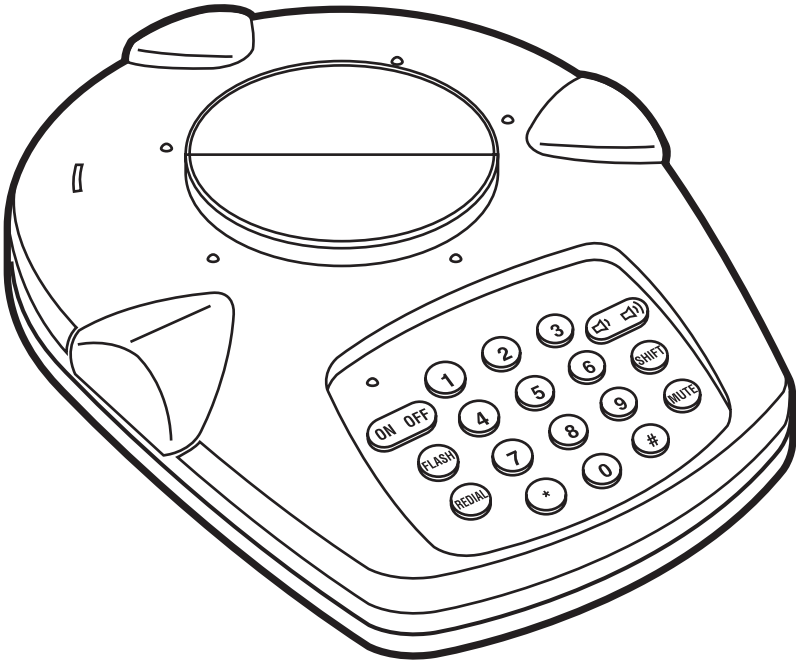

Conference 1 Phone



**CUSTOMER
SUPPORT
INFORMATION**

Order toll-free in the U.S.: Call **877-877-BBOX** (outside U.S. call **724-746-5500**)
FREE technical support 24 hours a day, 7 days a week: Call **724-746-5500** or fax **724-746-0746**
Mailing address: **Black Box Corporation**, 1000 Park Drive, Lawrence, PA 15055-1018
Web site: www.blackbox.com • E-mail: info@blackbox.com

FEDERAL COMMUNICATIONS COMMISSION AND INDUSTRY CANADA RADIO-FREQUENCY INTERFERENCE STATEMENTS

Class B Digital Device. This equipment has been tested and found to comply with the limits for a Class B computing device pursuant to Part 15 of the FCC Rules. These limits are designed to provide reasonable protection against harmful interference in a residential installation. However, there is no guarantee that interference will not occur in a particular installation. This equipment generates, uses, and can radiate radio-frequency energy, and, if not installed and used in accordance with the instructions, may cause harmful interference to radio communications. If this equipment does cause harmful interference to radio or telephone reception, which can be determined by turning the equipment off and on, the user is encouraged to try to correct the interference by one of the following measures:

- Reorient or relocate the receiving antenna.
- Increase the separation between the equipment and receiver.
- Connect the equipment into an outlet on a circuit different from that to which the receiver is connected.
- Consult an experienced radio/TV technician for help.

Caution:

Changes or modifications not expressly approved by the party responsible for compliance could void the user's authority to operate the equipment.

To meet FCC requirements, shielded cables and power cords are required to connect this device to a personal computer or other Class B certified device.

This digital apparatus does not exceed the Class A limits for radio noise emission from digital apparatus set out in the Radio Interference Regulation of Industry Canada.

Le présent appareil numérique n'émet pas de bruits radioélectriques dépassant les limites applicables aux appareils numériques de la classe A prescrites dans le Règlement sur le brouillage radioélectrique publié par Industrie Canada.

FEDERAL COMMUNICATIONS COMMISSION MODEM STATEMENT

1. The Federal Communications Commission (FCC) has established rules which permit this device to be directly connected to the telephone network with standardized jacks. This equipment should not be used on party lines or coin lines.
2. If this device is malfunctioning, it may also be causing harm to the telephone network; this device should be disconnected until the source of the problem can be determined and until the repair has been made. If this is not done, the telephone company may temporarily disconnect service.
3. If you have problems with your telephone equipment after installing this device, disconnect this device from the line to see if it is causing the problem. If it is, contact your supplier or an authorized agent.
4. The telephone company may make changes in its technical operations and procedures. If any such changes affect the compatibility or use of this device, the telephone company is required to give adequate notice of the changes.
5. If the telephone company requests information on what equipment is connected to their lines, inform them of:
 - a. The telephone number that this unit is connected to.
 - b. The ringer equivalence number.
 - c. The USOC jack required: RJ-11C.
 - d. The FCC registration number.Items (b) and (d) can be found on the unit's FCC label. The ringer equivalence number (REN) is used to determine how many devices can be connected to your telephone line. In most areas, the sum of the RENs of all devices on any one line should not exceed five (5.0). If too many devices are attached, they may not ring properly.
6. In the event of an equipment malfunction, all repairs should be performed by your supplier or an authorized agent. It is the responsibility of users requiring service to report the need for service to the supplier or to an authorized agent.

INDUSTRY CANADA MODEM STATEMENT

The Industry Canada (IC) label identifies certified equipment. This certification means that the equipment meets certain telecommunications-network protective, operation, and safety requirements. Industry Canada does not guarantee the equipment will operate to the user's satisfaction.

Before installing this equipment, users should ensure that it is permissible to be connected to the facilities of the local telecommunications company. The equipment must also be installed using an acceptable method of connection. In some cases, the company's inside wiring associated with a single-line individual service may be extended by means of a certified connector assembly (extension cord). The customer should be aware that compliance with the above conditions may not prevent degradation of service in some situations.

Repairs to certified equipment should be made by an authorized Canadian maintenance facility—in this case, Black Box. Any repairs or alterations made by the user to this equipment, or equipment malfunctions, may give the telecommunications company cause to request the user to disconnect the equipment.

Users should ensure for their own protection that the electrical ground connections of the power utility, telephone lines, and internal metallic water pipe system, if present, are connected together. This precaution may be particularly important in rural areas.

CAUTION:

Users should not attempt to make such connections themselves, but should contact the appropriate electric inspection authority, or electrician, as appropriate.

The LOAD NUMBER (LN) assigned to each terminal device denotes the percentage of the total load to be connected to a telephone loop which is used by the device, to prevent overloading. The termination on a loop may consist of any combination of devices, subject only to the requirement that the total of the load numbers of all the devices does not exceed 100.

**NORMAS OFICIALES MEXICANAS (NOM)
ELECTRICAL SAFETY STATEMENT****INSTRUCCIONES DE SEGURIDAD**

1. Todas las instrucciones de seguridad y operación deberán ser leídas antes de que el aparato eléctrico sea operado.
2. Las instrucciones de seguridad y operación deberán ser guardadas para referencia futura.
3. Todas las advertencias en el aparato eléctrico y en sus instrucciones de operación deben ser respetadas.
4. Todas las instrucciones de operación y uso deben ser seguidas.
5. El aparato eléctrico no deberá ser usado cerca del agua—por ejemplo, cerca de la tina de baño, lavabo, sótano mojado o cerca de una alberca, etc..
6. El aparato eléctrico debe ser usado únicamente con carritos o pedestales que sean recomendados por el fabricante.
7. El aparato eléctrico debe ser montado a la pared o al techo sólo como sea recomendado por el fabricante.
8. Servicio—El usuario no debe intentar dar servicio al equipo eléctrico más allá a lo descrito en las instrucciones de operación. Todo otro servicio deberá ser referido a personal de servicio calificado.
9. El aparato eléctrico debe ser situado de tal manera que su posición no interfiera su uso. La colocación del aparato eléctrico sobre una cama, sofá, alfombra o superficie similar puede bloquea la ventilación, no se debe colocar en libreros o gabinetes que impidan el flujo de aire por los orificios de ventilación.
10. El equipo eléctrico deber ser situado fuera del alcance de fuentes de calor como radiadores, registros de calor, estufas u otros aparatos (incluyendo amplificadores) que producen calor.
11. El aparato eléctrico deberá ser conectado a una fuente de poder sólo del tipo descrito en el instructivo de operación, o como se indique en el aparato.

12. Precaución debe ser tomada de tal manera que la tierra física y la polarización del equipo no sea eliminada.
13. Los cables de la fuente de poder deben ser guiados de tal manera que no sean pisados ni pellizcados por objetos colocados sobre o contra ellos, poniendo particular atención a los contactos y receptáculos donde salen del aparato.
14. El equipo eléctrico debe ser limpiado únicamente de acuerdo a las recomendaciones del fabricante.
15. En caso de existir, una antena externa deberá ser localizada lejos de las líneas de energía.
16. El cable de corriente deberá ser desconectado del cuando el equipo no sea usado por un largo periodo de tiempo.
17. Cuidado debe ser tomado de tal manera que objetos líquidos no sean derramados sobre la cubierta u orificios de ventilación.
18. Servicio por personal calificado deberá ser provisto cuando:
 - A: El cable de poder o el contacto ha sido dañado; u
 - B: Objetos han caído o líquido ha sido derramado dentro del aparato; o
 - C: El aparato ha sido expuesto a la lluvia; o
 - D: El aparato parece no operar normalmente o muestra un cambio en su desempeño; o
 - E: El aparato ha sido tirado o su cubierta ha sido dañada.

Contents

Chapter	Page
1. Specifications	7
2. Introduction	9
3. Installation	10
3.1 The Complete Package	10
3.2 Safety Precautions	11
3.3 Placement and Preparation	12
3.4 Connecting the Conference 1 to Phone Lines and Other Equipment	13
3.4.1 Connecting to a Standard Telephone Line	14
3.4.2 Connecting to a Computer's Sound Card	16
3.4.3 Configuring a Windows PC's Sound Card for Use With the Conference 1	17
3.4.4 Connecting to a Modem	19
3.4.5 Connecting to a Two-Line Telephone Service	21
3.4.6 Connecting to a Digital Telephone System	23
3.4.7 Connecting to an Audio-Recording Device	25
4. Operation	26
4.1 Echo Cancellation and Noise Reduction	26
4.2 Setting the PULSE/TONE Switch	27
4.3 Placing a Standard Call	27
4.4 Receiving a Call	28
4.5 Muting	28
4.6 Redialing	28
4.7 Controlling Flash Features	28
4.8 Making Volume Adjustments	29
5. Maintenance and Troubleshooting	30
5.1 Cleaning the Conference 1	30
5.2 Things to Check If Something Goes Wrong	30
5.3 Calling Black Box	32
5.4 Shipping and Packaging	32
Legal Information	33

1. Specifications

Compliance:	EMI/RFI: FCC Part 15 Subpart J Class B, IC Class/ classe B; Phone-system compatibility: FCC Part 68
Cable Required:	Between phone and wall or phone and computer sound card: Proprietary (included)
Interfaces:	To line/AC: Proprietary combined voice/power; To sound card: 3.5-mm mini stereo audio; To audio-recording device: RCA audio
FCC Part 68 Registration Number:	5MJ-TAI-32805-DP-N
Ringer Equivalence Number:	1.1 B
Line Type:	Phone supports two- or four-wire lines, as well as extension lines from PBXes (although additional equipment will be required for anything but standard phone lines)
Operation:	Full duplex
User Controls:	Bottom-mounted pulse/tone slide switch; Top-mounted 18-key keypad for dialing and other functions (see Chapter 4); If the phone is communicating through a computer's sound card, sound can be controlled to some degree through the computer's operating system and applications (see Section 3.4.3)
Indicators:	Top-mounted ON/OFF LED; Plays self-test audio sound effects at power-up
Connectors:	(3) Side-mounted: (1) RJ-45 for voice I/O and input power; (1) 3.5-mm mini stereo female for sound-card I/O; (1) RCA female for output to audio recorder

CONFERENCE 1 PHONE

Temperature

Tolerance: Operating: 41 to 104°F (5 to 40°C);
Storage: 41 to 158°F (5 to 70°C)

Humidity

Tolerance: Operating: 50 to 80% noncondensing;
Storage: 10 to 90% noncondensing

Enclosure: High-impact plastic

Power: From outlet through special UL® and cUL® approved
power supply and attached line cords:
Input: 90 to 120 VAC, 60 Hz;
Consumption: 15 watts

Size: 2.7"H x 9"W x 10.5"D (6.9 x 22.9 x 26.7 cm)

Weight: 2 lb. (0.9 kg)

2. Introduction

Thank you for choosing the Conference 1 Phone. It incorporates technology that allows for 360-degree dynamic audio pickup. As it does so, it will track the direction of the speaker's voice, lighting the nearest LEDs to let you know you're being heard at the locations you've called. The Conference 1 also features the most advanced echo cancellation available in a conference phone, as well as superior background-noise reduction. It is full-duplex—its speakers and microphones operate simultaneously—so you can both listen and speak at the same time.

The rest of this manual describes how to install and use your Conference 1. Please pay particular attention to the electrical-safety precautions listed in **Section 3.3**. If after reading this manual you still have questions about any of the phone's functions or components, feel free to call Black Box Technical Support as described in **Chapter 5**.

3. Installation

3.1 The Complete Package

Make sure you've received everything else that should have been shipped with your Conference 1 base unit (compare with Figure 3-1):

- Conference 1 power supply with these attached cables:
 - 3-foot (1-m) power-input cord (to AC outlet);
 - 6-foot (1.8-m) telephone cord with an RJ-11 (6-wire/2-pin) plug (to phone-system wall jack); and
 - 25-foot (7.6-m) base-unit cord with an RJ-45 (8-wire/8-pin) plug.
- 3-foot (1-m) computer sound-card cable. One end has a single mini stereo plug and the other end has two mini stereo plugs.
- This manual.

If anything's missing, contact Black Box. However, the manufacturer and their authorized agents are not responsible for any damage that might have occurred during shipping; you must make claims directly with the carrier. Inspect your shipment carefully for obvious signs of damage. If you find any, keep the original boxes and packing material for inspection by the carrier and contact your carrier immediately.

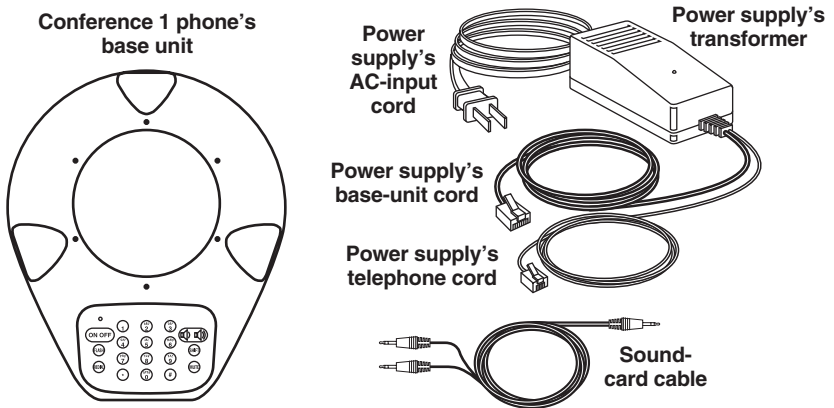

Figure 3-1. The Conference 1 and the accessories that ship with it.

3.2 Safety Precautions

IMPORTANT NOTE

You should read and understand the warnings and instructions in this section before you place, install, operate, or maintain the Conference 1.

Take these precautions in order to avoid having problems with your Conference 1:

- Follow all of the instructions and warnings printed on the Conference 1's housing.
- Do *not* put anything on top of the Conference 1, and don't allow papers or other objects to obstruct its microphones.
- Do *not* allow anything to rest on the cords and cables connected to your Conference 1.
- Do *not* put your Conference 1 where its cords can be walked on.
- Be careful not to overload wall outlets and extension cords; doing so poses a risk of fire or electric shock.
- *Never* push objects of any kind into the openings on your Conference 1's base unit or power supply. Objects might touch dangerous voltage points or short out parts, which could also pose a risk of fire or electric shock.
- Try not to spill liquid of any kind on your Conference 1's base unit or power supply. If this ever happens, do *not* continue to use the Conference 1; use another phone to call Black Box Technical Support.
- *Never* try to disassemble your Conference 1's base unit or power supply. They don't contain any user-serviceable parts; opening them can expose you to dangerous voltages and other risks; and reassembling them incorrectly can cause equipment damage and/or electric shock the next time the Conference 1 is operated. Instead, call Black Box Technical Support to arrange to have the Conference 1 repaired.
- Avoid using your Conference 1 during an electrical storm. There can be a remote risk of electric shock from lightning.
- Do *not* use your Conference 1 to report a gas leak. The phone's buttons route electrical signals when pressed. These signals can ignite gas fumes, which could cause a fire or explosion. Instead, report the leak from another location that's not involved.

- When you clean the Conference 1, make sure it's unplugged from the AC outlet. Do *not* use liquid or aerosol cleaners. Instead, use a damp cloth moistened with water to clean the outside of your Conference 1's base unit and power supply.
- It's conceivable that you might have another power supply whose output cord is terminated with an RJ-45 plug. However, the power supply that we ship with the Conference 1 is still the only power supply that you should use with it. Using a power supply rated for different voltages or currents than the Conference 1 expects could damage the Conference 1 and attached devices.

3.3 Placement and Preparation

The Conference 1 should be placed on a steady flat surface such as a desk or tabletop near the center of your conference room. The room shouldn't be larger than 20 feet by 20 feet (6 m by 6 m). The Conference 1 should be at least 8" (20 cm) from the edge of the desk or table, at least 18" (46 cm) from any wall, and within 4 to 6 ft. (1.2 to 1.8 m) of the seats of all people who will be speaking during phone calls. If there is a sticker on the Conference 1's speaker, remove it.

Don't put your Conference 1 on any unstable cart, stand, table, etc. And don't place the Conference 1 in damp areas or near places where water can collect. (For example, don't place it near a pool, tub, wash basin, or sink, and don't place it in a wet basement.) If the Conference 1 falls or gets wet, it could be seriously damaged.

Don't put your Conference 1 near any noisy equipment or fixtures (ventilation ducts, loudly humming PCs, etc.). The Conference 1 can reduce, but not eliminate, background noise.

The Conference 1 is preset for touchtone dialing. If your site's telephone service doesn't include touchtone dialing, slide the PULSE/TONE switch on the bottom of the Conference 1 to the PULSE position. See **Section 4.2**.

If you want to connect the Conference 1 to a two-line phone service, you'll need a line splitter. These are available at telephone-supply stores. See **Section 3.4.5**.

If your site's telephones are on a digital (PBX) system, you'll need an analog-to-digital telephone converter to connect the Conference 1 to one of your site's digital phones. We recommend our Conference Linc Up (product code MC117A). See **Section 3.4.6**.

If you want to connect the Conference 1 to an audio-recording device, you'll need an auxiliary-input cable suitable for the device. Use the cable recommended for this purpose in the device's manual. See **Section 3.4.7**.

3.4 Connecting the Conference 1 to Phone Lines and Other Equipment

Installing your Conference 1 is almost as easy as installing an ordinary telephone. The following subsections describe how you can connect your Conference 1 to any of these things:

- A standard telephone line (see **Section 3.4.1**);
- A computer's sound card, or other four-wire system (see **Sections 3.4.2** and **3.4.3**);
- A modem (to share the phone line—see **Section 3.4.4**);
- Two-line telephone service (see **Section 3.4.5**);
- A digital telephone system (see **Section 3.4.6**); or
- An audio-recording device (see **Section 3.4.7**).

NOTE

These subsections frequently mention the RJ plugs on the cords attached to the Conference 1's power supply. One of these, an RJ-11 plug, is a 6-wire type (RJ-12) as opposed to a 4-wire type, but only carries two pins. The other plug is an 8-wire RJ-45 carrying all 8 pins.

Figure 3-2 shows the side of the Conference 1, including the connectors where you'll make these attachments. All connector labels are on the bottom of the unit.

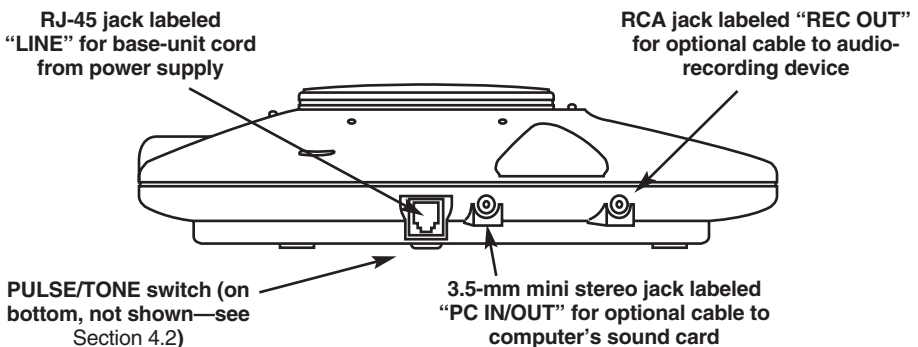

Figure 3-2. The side of the Conference 1.

3.4.1 CONNECTING TO A STANDARD TELEPHONE LINE

NOTE

Before connecting your Conference 1 to anything you believe to be a standard phone line—especially at a corporate site with a large number of phones—verify that you have standard analog phone service. If you have digital (PBX) telephone service, you'll need a digital-to-analog telephone-line converter. See Section 3.4.6.

To connect your Conference 1 to a standard telephone line, take these steps (referring to Figure 3-3 on the next page):

1. The Conference 1's power supply has three cords attached to the transformer. Take the one terminated with an RJ-11 plug and plug it into a standard telephone-system wall jack.
2. Plug the power supply's long base-unit cord—the one terminated with an RJ-45 plug—into the Conference 1 base unit's RJ-45 jack, labeled LINE on the bottom of the unit.
3. Plug the power-supply's AC-input cord into a working standard 120-VAC electrical outlet. (If the outlet is controlled by a wall switch, turn it on.) The Conference 1 should play a sequence of self-test sound effects to indicate that it's receiving power.
4. Press the ON/OFF button to check for a dial tone. If you hear a dial tone, the Conference 1 is ready for operation. If you don't, see **Section 5.2**.

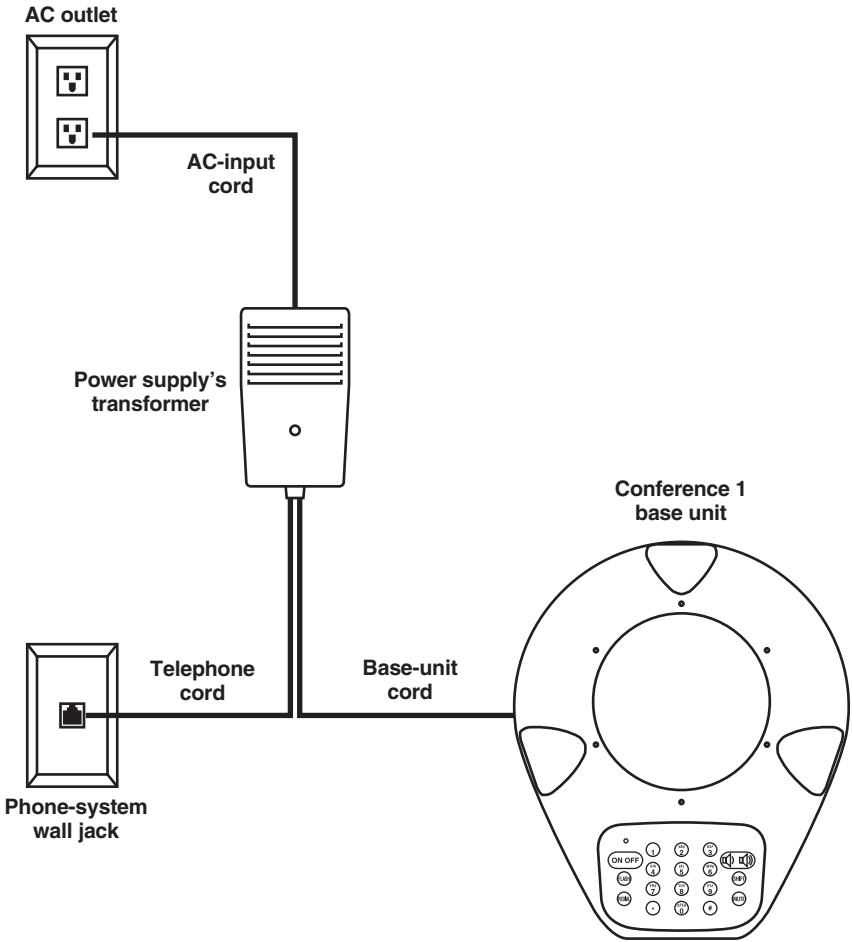

Figure 3-3. Attaching the Conference 1 to a standard phone line.

3.4.2 CONNECTING TO A COMPUTER'S SOUND CARD

You can connect your Conference 1 to a computer's sound card or any other four-wire system that supports full-duplex operation, such as some videoconferencing equipment and dedicated voice networks. You'll do this with a sound-card cable that ships from the factory with the Conference 1. This cable has a single mini stereo plug at one end and two mini stereo plugs at the other end. Take these steps, referring to Figure 3-4 (power-supply connections aren't shown):

1. Plug the sound-card cable's single-connector end (a black plug) into the PC IN/OUT jack on your Conference 1 base unit.
2. Plug the cable's dual-connector end (red and black plugs) into the sound card or other device: Plug the red plug into the audio LINE OUT jack, and plug the black plug into the LINE IN jack. These jacks might look like those shown in Figure 3-4, or the symbols might be different; consult the device's manual if you're not sure which jacks you should use.
3. The Conference 1's power supply has three cords attached to the transformer. (You won't use the one terminated with an RJ-11 plug.) Plug the power supply's long base-unit cord—the one terminated with an RJ-45 plug—into the LINE jack on the Conference 1 base unit.
4. Plug the power-supply's AC-input cord into a working standard 120-VAC electrical outlet. (If the outlet is controlled by a wall switch, turn it on.) The Conference 1 should play a sequence of self-test sound effects.

If you've attached the Conference 1 to a computer's sound card, you'll need to turn on the Conference 1 by pressing the SHIFT and ON/OFF buttons at the same time in order to activate the sound-card connection. If the sound card is installed in a Windows® PC, you'll need to configure the PC as described in **Section 3.4.3**.

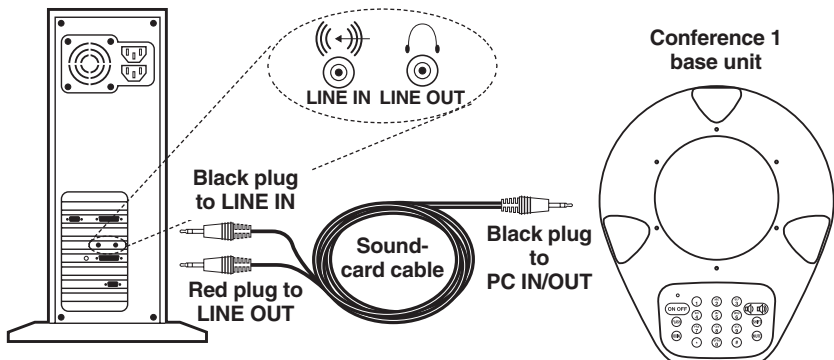

Figure 3-4. Attaching the Conference 1 to a computer's sound card.

3.4.3 CONFIGURING A WINDOWS PC'S SOUND CARD FOR USE WITH THE CONFERENCE 1

If you connect the Conference 1 phone to the sound card of a PC running Microsoft® Windows, you might need to configure it as described in this section. For the Volume Control adjustments refer to Figure 3-5 on the next page.

To mute external signals with Microsoft Volume Control—Playback:

1. Run the Volume Control program. From the Start menu, follow one of these paths, depending on your operating system: either “Programs\Accessories\Entertainment\Volume Control” (Windows 98 and 2000) or “Programs\Accessories\Multimedia\Volume Control” (Windows 95).
2. Select “MUTE” for “Line In Balance.”

To select external signals with Microsoft Volume Control—Recording:

1. From the “Volume Control” menu, select “Options.”
2. Choose “Properties” from the Options menu.
3. At the “Adjust volume for” option, select “Recording.”
4. At the “Show the following volume controls” option, select “Line In.”
5. Press “OK.”
6. Adjust the “Line In Balance” as necessary.

To use Microsoft NetMeeting®:

1. Run the NetMeeting program.
2. Choose “Options” from the Tools menu.
3. Select “Audio” from the Options menu.
4. Deselect (uncheck) “Enable Auto-Gain Control.”

When you're ready to use the Conference 1 with the PC:

1. Turn off the Conference 1.
2. Power the up the Conference 1 by pressing its SHIFT and ON/OFF buttons at the same time. The Conference 1 will use the link to the PC's sound card until you press ON/OFF again.

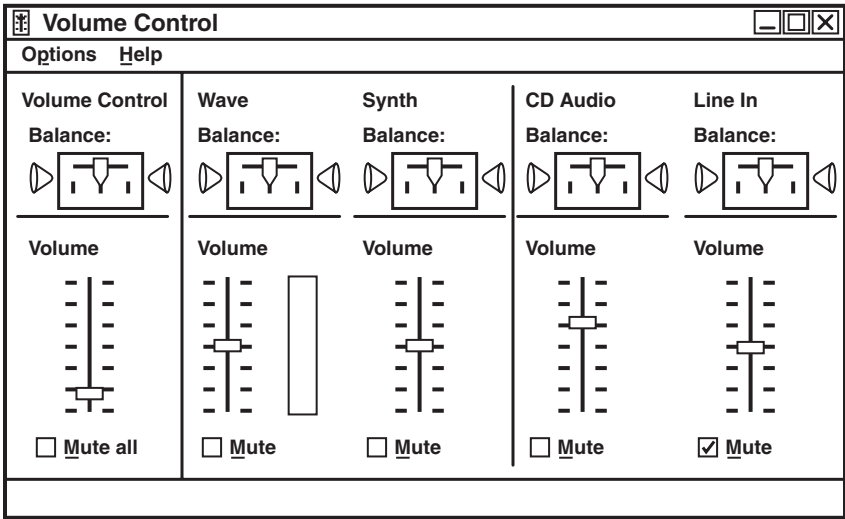

Figure 3-5. The Volume Control window.

3.4.4 CONNECTING TO A MODEM

You can connect your modem and computer to the same single telephone line that you're using for your Conference 1. Take the steps listed below, referring to Figure 3-6 on the next page. If you have any questions about the connectors on, or cables to use with, your modem or computer, refer to the modem's or computer's manual.

1. Run regular telephone cable from your modem's telephone-line jack (usually marked "LINE") to a standard telephone-system wall jack.
2. If your modem is an external type rather than a modem card, run cable from its computer port (often marked "COMPUTER" or "DTE") to the appropriate port on your computer (usually one of its DB9 or DB25 serial ports).
3. The Conference 1's power supply has three cords attached to the transformer. Take the one terminated with an RJ-11 plug and plug it into the modem's telephone pass-through jack (often marked "PHONE").
4. Plug the power supply's long base-unit cord—the one terminated with an RJ-45 plug—into the LINE jack on the Conference 1 base unit.
5. Plug the power-supply's AC-input cord into a working standard 120-VAC electrical outlet. (If the outlet is controlled by a wall switch, turn it on.) The Conference 1 should play a sequence of self-test sound effects to indicate that it's receiving power.
6. Press the ON/OFF button to check for a dial tone. If you hear a dial tone, the Conference 1 is ready for operation. If you don't, see **Section 5.2**.

CONFERENCE 1 PHONE

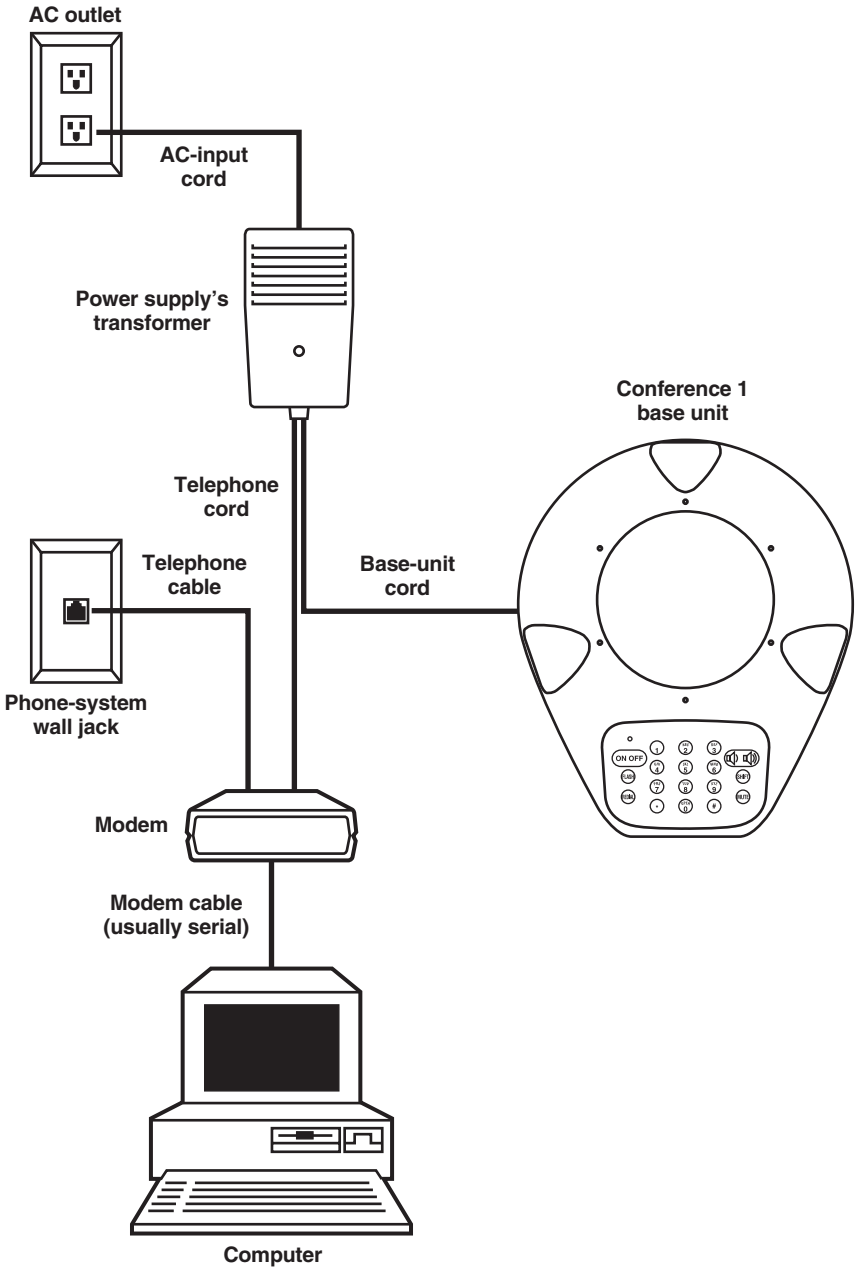

Figure 3-6. Attaching the Conference 1 to a modem (to share its phone line).

3.4.5 CONNECTING TO A TWO-LINE TELEPHONE SERVICE

Your Conference 1 can operate on one line of a two-line telephone service. To attach the Conference 1 to such a line, you'll need a two-line telephone-line splitter, which routes the two telephone lines—normally expressed on two different wire pairs of the same jack—into two separate jacks. Line splitters are available from most telephone-supply stores. Take these steps, referring to Figure 3-7 on the next page:

1. Plug the line splitter into your two-line telephone jack.
2. The Conference 1's power supply has three cords attached to the transformer. Take the one terminated with an RJ-11 plug and plug it into one of the jacks on the line splitter.
3. Plug the power supply's long base-unit cord—the one terminated with an RJ-45 plug—into the LINE jack on the Conference 1 base unit.
4. Plug the power-supply's AC-input cord into a working standard 120-VAC electrical outlet. (If the outlet is controlled by a wall switch, turn it on.) The Conference 1 should play a sequence of self-test sound effects to indicate that it's receiving power.
5. Press the ON/OFF button to check for a dial tone. If you hear a dial tone, the Conference 1 is ready for operation. If you don't, see **Section 5.2**.
6. If you want to, plug a standard single-line telephone or other single-line device into the other jack on the line splitter.

CONFERENCE 1 PHONE

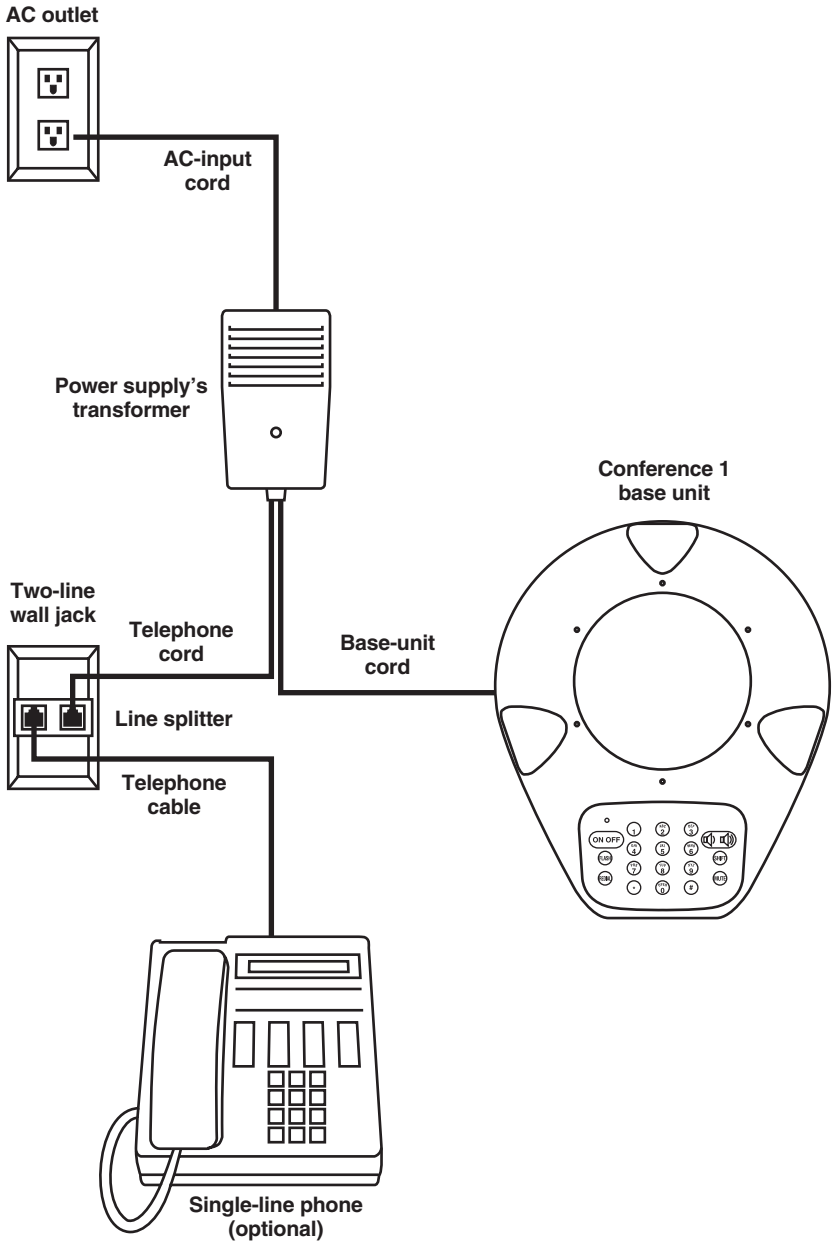

Figure 3-7. Attaching the Conference 1 to a two-line phone service.

3.4.6 CONNECTING TO A DIGITAL TELEPHONE SYSTEM

Many businesses and other large sites don't use standard analog phone lines. Instead, they use digital phone systems that route calls through a PBX (private branch exchange). If you have to dial "9" or some other digit to reach an outside line at your site, you probably have a digital system, but check just to make sure. If you do have digital (PBX) telephone service, you'll need a digital-to-analog telephone-line converter in order to use the Conference 1. We offer several of these converters; at the time of this writing, one that we recommend (and that is specially designed for use with conference phones) is the Conference Linc Up, product code MC117A. Be aware that any such converter will degrade the sound quality of your conversations.

To connect your Conference 1 to a digital telephone system, take these steps, referring to Figure 3-8 on the next page:

1. Follow the instructions in the digital-to-analog converter's manual for connecting the converter to one of the digital telephones connected to your PBX system. Make sure to use the proper impedance setting. (Most converters have a four-position switch to match the converter's impedance with that of the type of digital phone you're using. Your converter's manual should tell you which setting to use.)
2. The Conference 1's power supply has three cords attached to the transformer. Take the one terminated with an RJ-11 plug and plug it into the jack on the digital-to-analog converter.
3. Plug the power supply's long base-unit cord—the one terminated with an RJ-45 plug—into the LINE jack on the Conference 1 base unit.
4. Plug the power-supply's AC-input cord into a working standard 120-VAC electrical outlet. (If the outlet is controlled by a wall switch, turn it on.) The Conference 1 should play a sequence of self-test sound effects to indicate that it's receiving power.
5. Lift the digital phone's handset. Press the Conference 1's ON/OFF button to check for a dial tone. If you hear a dial tone, the Conference 1 is ready for operation. (If you don't, consult the digital-to-analog converter's manual; also see **Section 5.2**.) Turn the Conference 1 back off and hang up the handset.

To make a call once you've installed the Conference 1, lift the digital phone's handset and dial the number on the digital phone *before* you turn on the Conference 1. After you dial, turn on the Conference 1 by pressing its ON/OFF button. Leave the digital phone's handset off the hook during the call. To end the call, hang up the handset.

CONFERENCE 1 PHONE

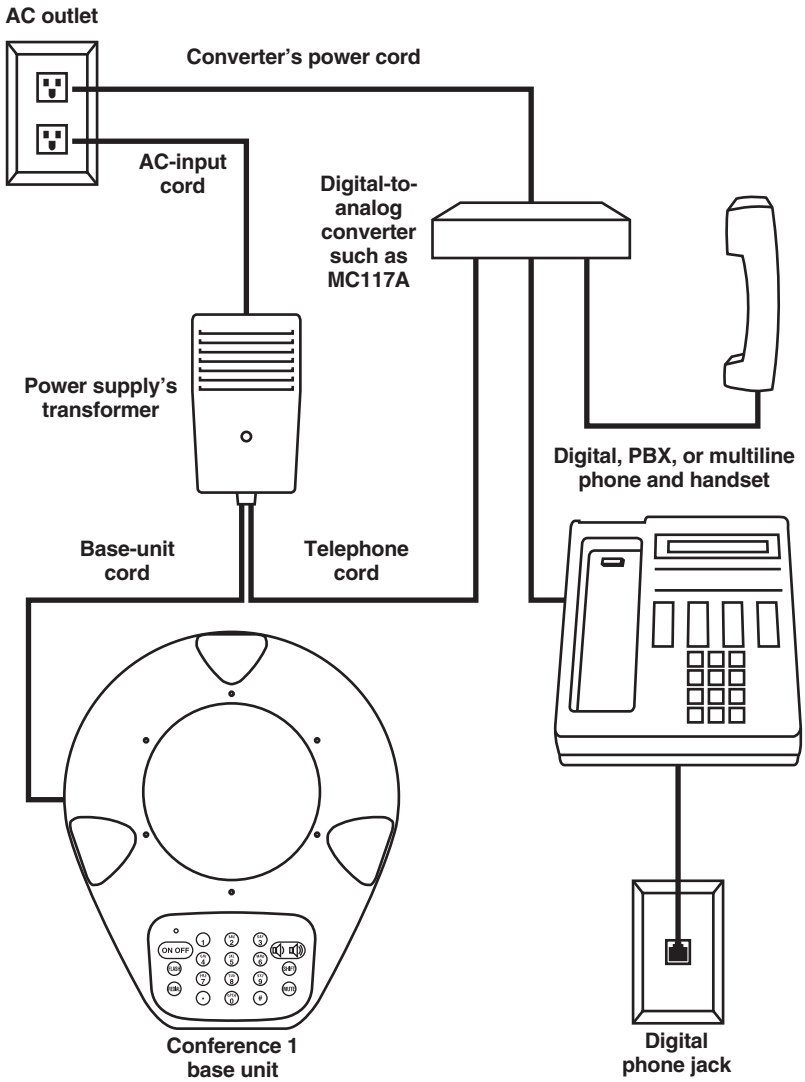

Figure 3-8. Attaching the Conference 1 to a digital (PBX) phone system.

3.4.7 CONNECTING TO AN AUDIO-RECORDING DEVICE

Your Conference 1 has an RCA® jack so that you can record your conference calls directly with a tape recorder or other audio-recording device. To connect the Conference 1 to such a device as shown in Figure 3-9, you'll need an auxiliary-input cable suitable for the device (refer to its manual). Plug one end of this cable into the RCA jack on the Conference 1 labeled (on the bottom of the unit) REC OUT. Plug the other end into the recording device's LINE IN jack.

NOTE

Recording phone conversations without the knowledge and consent of all of the participants is illegal in many areas. Before recording a call through your Conference 1, be sure that the parties involved are informed that the call is being recorded. If in doubt, consult legal counsel.

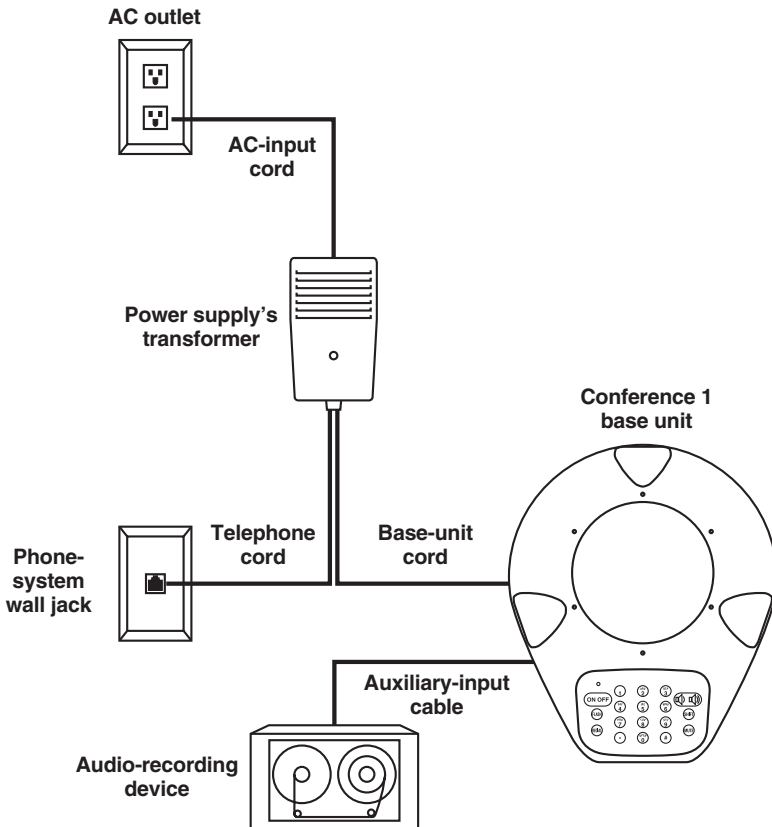

Figure 3-9. Attaching the Conference 1 to an audio-recording device. (Standard phone-system connections are also shown.)

4. Operation

Except for the PULSE/TONE switch mentioned in **Section 4.2**, the buttons on its keypad are the Conference 1's only controls. These are shown in Figure 4-1.

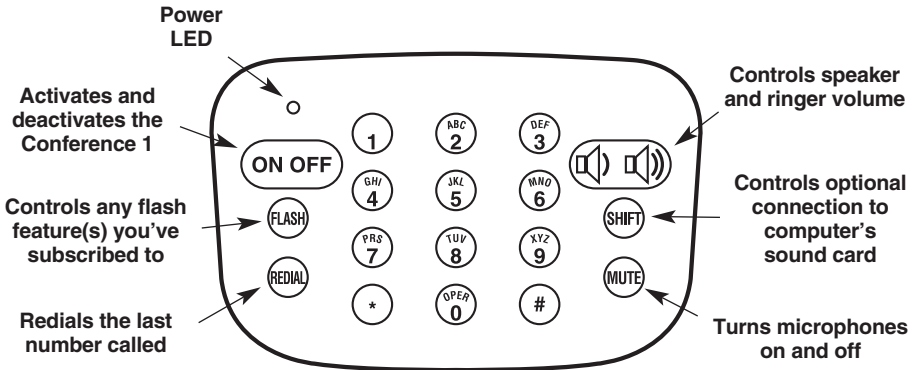

Figure 4-1. The Conference 1's keypad.

4.1 Echo Cancellation and Noise Reduction

The Conference 1 makes conference calls a lot easier on the parties at the other end of the line by performing sophisticated echo cancellation that edits the Conference 1's speaker output out of the microphone input. Remote parties won't have to try to hear what's being said at your site over the sound of their own voices.

When the Conference 1 performs its initial power-up self-test, it also "samples" the room it's in with inaudible sound signals in order to determine the size and shape of the room for echo-cancellation purposes. If the Conference 1 later detects that it has been moved, it will resample the room so that it can continue providing the best possible echo cancellation. (When it does this resampling, it will produce the same sound effects that it did when it was first powered up.)

In addition to cancelling echoes, the Conference 1 reduces background noise to provide clearer audio for remote listeners. While this reduction is significant, it's not complete; you still need to keep the Conference 1 away from noise sources.

4.2 Setting the PULSE/TONE Switch

If you can pick up a phone at your site, dial a number, hear touchtones as you press the keys, and have the call go through, then you can leave the Conference 1 set to its factory-default tone-dial setting. But if your site uses only rotary phones, or for whatever other reason does not have touchtone service—that is, if the line doesn't seem to recognize or respond to touchtones—you'll have to move the PULSE/TONE slide switch on the bottom of the Conference 1 to the PULSE position. This will cause the Conference 1 to dial with make/break pulses, as a rotary phone would.

Even if you have to switch the Conference 1 to PULSE for dialing, you can switch it back to TONE in the middle of a call in order to use a touchtone-recognition system (for example, to enter a calling-card number, to select options in a tone-controlled menu, etc.). Just switch to PULSE again before placing your next call.

4.3 Placing a Standard Call

To place a simple point-to-point phone call with the Conference 1 when it's connected to a standard phone line, take these steps:

1. Turn on your Conference 1 by pressing its ON/OFF button . The power LED should come on and you should hear a dial tone. If the LED doesn't light and you don't hear a dial tone, make sure that the Conference 1's power supply is plugged in, that its power LED is on, and that all other connections are secure; also see **Section 5.2**.
2. Type in the phone number of the party you're trying to reach. When the call is answered, the status LEDs around the top of the Conference 1 will become active; each LED will light in response to sound detected by the corresponding microphone.
3. When you're finished with your call, press the ON/OFF button again to hang up. The power LED and status LEDs will go dark.

You'll need to use a different procedure to make a call if the Conference 1 is connected to a digital phone system; see the end of **Section 3.4.6**.

4.4 Receiving a Call

To receive a standard point-to-point phone call with the Conference 1, take these steps:

1. When you hear your Conference 1 ringing and see its power LED flash, you can answer it by pressing its ON/OFF button . You can then speak to the caller. The power LED will become solidly lit, and the status LEDs around the top of the Conference 1 will become active. Each status LED will light in response to sound detected by the corresponding microphone.
2. When you're finished with your call, press the ON/OFF button again to hang up. The power LED and status LEDs will go dark.

4.5 Muting

The Conference 1's MUTE button  controls whether or not the other party can hear you by turning the Conference 1's microphones off and on. To mute your conversation, press the MUTE button during a call to turn the microphones off. The status LEDs around the top of the Conference 1 will begin flashing about once a second. To turn the microphones back on, press MUTE again; the status LEDs will stop flashing.

4.6 Redialing

To redial the last number you called, press the Conference 1's ON/OFF button  to get a dial tone, then press the REDIAL button .

4.7 Controlling Flash Features

Many local telephone companies offer features such as call transfer, call waiting, or conference calling that are controlled by quickly “flashing” the phone on and off hook. To do this, you can use the Conference 1's FLASH button —it functions just like the “hook button” that a regular phone's handset rests on. But the specifics of when you'll need to press the button, how long you'll need to hold it down, how many times you'll have to press and release it, etc., are different for different telephone companies. Please contact them for more information about any flash features you might have subscribed to.

4.8 Making Volume Adjustments

You can control the Conference 1's speaker or ringer volume by pressing its volume-control button . Take these steps:

1. If you want to adjust the volume of the sound produced by the Conference 1's *speakers* (callers' voices, dial tone, etc.), make sure the Conference 1 is turned *on* (is off hook, so that dial tone is audible). If you want to adjust the volume of the sound produced by the Conference 1's *ringer*, make sure the Conference 1 is turned *off* (is on hook). You can turn the Conference 1 on or off by pressing the ON/OFF button .
2. To make the chosen volume louder or softer *one step at a time*, press and *release* either the left side (softer) or the right side (louder) of the volume-control button. The volume of the dial tone (if you're adjusting the speakers) or of a sample ring that the Conference 1 emits (if you're adjusting the ringer) will change by a discrete amount. Also, some of the status LEDs around the top of the Conference 1 will begin to flash rapidly. Which LEDs are flashing and which are dark will depend on the volume level, and this pattern changes as you change the volume: The status LEDs begin flashing in clockwise order as the volume gets louder, and go dark in counterclockwise order as the volume gets softer.)

To run the volume *smoothly* up or down, press and *hold* either the left side (softer) or the right side (louder) of the volume-control button. The volume will get continuously louder or softer; again, the flashing-vs.-dark pattern of the status LEDs will change correspondingly.

When you reach the highest or lowest volume setting for the chosen volume, all LEDs or only one LED will be flashing respectively, and the volume won't change any further in that direction.

5. Maintenance and Troubleshooting

5.1 Cleaning the Conference 1

Under normal conditions, it shouldn't be necessary to clean the Conference 1 any more often than other office equipment. When you do so, however, take these precautions in order to avoid electric shock:

- Follow all warnings and instructions printed on the Conference 1.
- Unplug the Conference 1's power supply from the AC outlet before you begin cleaning the base unit or power supply.
- Do *not* use liquid or aerosol cleaners. Instead, wipe the outside of the Conference 1's base unit and power supply with a cloth lightly moistened with water.

5.2 Things to Check If Something Goes Wrong

If you're having trouble with your Conference 1, it might not be set up properly, or equipment connected to it might be improperly configured or malfunctioning. Here are a few things to check first; if the problem isn't related to one of these things, look for your specific problem among those listed on the next page. Make sure that:

- The Conference 1's power supply is plugged into a 120-volt electrical outlet, and its power LED is lit.
- The cord running from the Conference 1's power supply to its base unit is securely connected to the base unit.
- The telephone cord from the power supply is securely connected to the telephone-system wall jack.
- The phone equipment and service being used by the party you're trying to call is comparable in quality to the Conference 1 and is working properly.

If you get no dial tone:

- Your Conference 1 might not be set up properly. See **Section 3.3**.
- The Conference 1 might not be connected to a standard analog phone line. If your site's phone system is a digital (PBX) system, you'll need a digital-to-analog converter. See **Section 3.4.6**.

You might need to consult with your telecommunications personnel if you get no dial tone.

If you hear static, background noise, or excessive noise of other kinds:

- You might have a bad connection. Try placing the call again.
- You might have a bad line. Plug a standard phone into the phone-system jack that Conference 1 is using; if you still get noise, call your telephone company.
- The other party's room is too noisy. Ask them to locate and quiet the source of the noise if they can.

If sound from the other location is muffled or echoes:

- The other party might be in a very large room. Ask them to either move closer to their phone's microphones or call from a smaller room.
- If you're using the Conference 1 with a computer's sound card (see **Section 3.4.2**), you might have reversed the connectors on the dual end of the sound-card cable: Make sure that the *red* plug is attached to the card's LINE OUT jack and the *black* plug is attached to the LINE IN jack.
- The other party might be using low-quality equipment. Ask them to swap in better equipment, if possible.

If you can receive calls but not place calls:

- The PULSE/TONE switch on the bottom of the Conference 1 (see **Section 4.2**) might be set incorrectly. Fix it.
- Your calls might be going through a digital (PBX) phone system. You'll need to dial "9" or some other digit to reach an outside line. See **Section 3.4.6**.

If none of these suggestions help, please call Black Box Technical Support as described in the next section.

5.3 Calling Black Box

If you determine that your Conference 1 is malfunctioning, *do not attempt to alter or repair it*. It contains no user-serviceable parts. Contact Black Box Technical Support at 724-746-5500. In particular, you'll need to call and arrange for repairs if any of these things happens:

- The Conference 1 is dropped or otherwise suffers serious impact damage.
- Liquid is spilled into the Conference 1's base unit or power supply.
- The power-supply cords become broken, damaged, or frayed.
- The Conference 1 fails to operate normally despite the fact that you've carefully followed all of its operating instructions.
- The Conference 1 starts performing badly.

Before you call about any operating problem you haven't been able to solve, make a record of the history of the problem. We will be able to provide more efficient and accurate assistance if you have a complete description, including:

- the nature and duration of the problem;
- when the problem occurs;
- the components involved in the problem;
- any particular application that, when used, appears to create the problem or make it worse; and
- the results of any testing you've already done.

5.4 Shipping and Packaging

If you need to transport or ship your Conference 1:

- Package it carefully. We recommend that you use the original container.
- If you're shipping the Conference 1 for repair, please include its power supply and cables. If you're returning the Conference 1, please include everything you received with it. Before you ship the Conference 1 back to Black Box for repair or return, please contact us to get a Return Authorization (RA) number.

DISCLAIMER

In no event will the manufacturer or its authorized agents be liable for any special, indirect, incidental, punitive, or consequential damages of any kind or character, including but not limited to loss of revenue or profits, failure to realize savings or other benefits, loss of data or usability, damage to equipment, or claims against the purchaser by a third party, even if the manufacturer or its agents have been advised of the possibility of such damages.

The laws of some areas don't allow the exclusion or limitation of incidental or consequential damages, so those exclusions in this disclaimer might not apply to you.

TRADEMARKS USED IN THIS MANUAL

BLACK BOX and the  logo are registered trademarks of Black Box Corporation.

Microsoft, Windows, and NetMeeting are registered trademarks or trademarks of Microsoft Corporation in the United States and/or other countries.

RCA is a registered trademark of Thomson Consumer Electronics, Inc., a subsidiary of Thomson multimedia.

Any other trademarks mentioned in this manual are acknowledged to be the property of the trademark owners.

NOTES



© Copyright 2001. Black Box Corporation. All rights reserved.

1000 Park Drive • Lawrence, PA 15055-1018 • 724-746-5500 • Fax 724-746-0746