

MARCH 2000

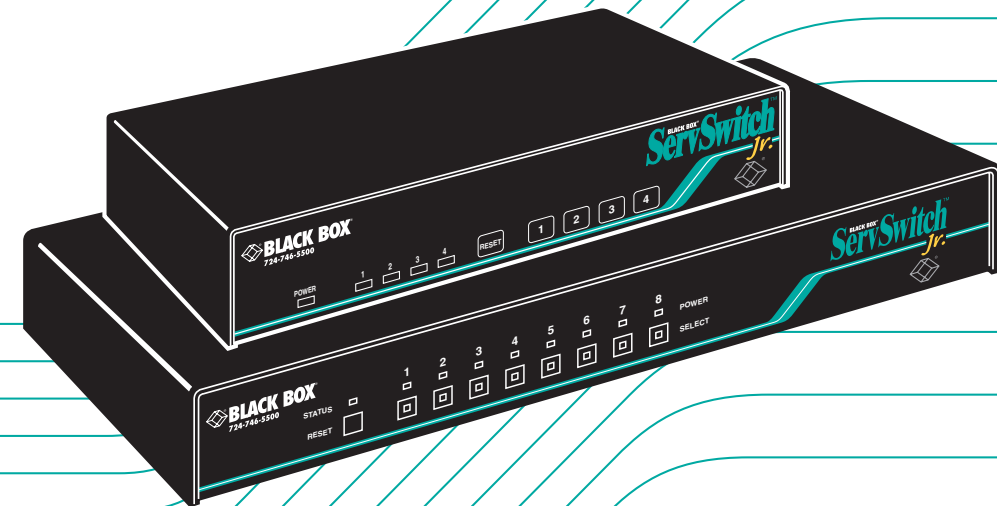

BLACK BOX™
ServSwitch
Jr.



SW621A-R2
SW622A-R2
SW629A-R2

Customer Support Information:

FREE tech support 24 hours a day, 7 days a week: Call 724-746-5500 or fax 724-746-0746.
Mailing address: Black Box Corporation, 1000 Park Dr., Lawrence, PA 15055-1018
World-Wide Web: www.blackbox.com • E-mail: info@blackbox.com
© Copyright 2000. Black Box Corporation. All rights reserved.



Welcome to the ServSwitch™ Family!

Thank you for purchasing a BLACK BOX® ServSwitch™ Brand KVM switch! We appreciate your business, and we think you'll appreciate the many ways that your new ServSwitch keyboard/video/mouse switch will save you money, time, and effort.

That's because our ServSwitch family is all about breaking away from the traditional, expensive model of computer management. You know, the one-size-fits-all-even-if-it-doesn't model that says, "One computer gets one user station, no more, no less." Why not a single user station (monitor, keyboard, and mouse) for multiple computers—even computers of different platforms? Why not a pair of user stations, each of which can control multiple computers? Why not multiple user stations for the same computer?

With our ServSwitch products, there's no reason why not. We carry a broad line of robust solutions for all these applications. Do you have just two PCs, and need an economical alternative to keeping two monitors, keyboards, and mice on your desk? Or do you need to share dozens of computers, including a mix of IBM® PC, RS/6000®, Apple® Macintosh®, Sun Microsystems®, and SGI® compatibles among multiple users with different access levels? Does your switch have to sit solidly on a worktable and use regular everyday cables? Or does it have to be mounted in an equipment rack and use convenient many-to-one cables? No matter how large or small your setup is, no matter how simple or how complex, we're confident we have a ServSwitch system that's just right for you.

The ServSwitch™ family from Black Box—the one-stop answer for all your KVM-switching needs!

*

This manual will tell you all about your new ServSwitch™ Jr. unit, including how to install, operate, and troubleshoot it. For an introduction to the ServSwitch Jr. unit itself, see **Chapter 2**. The ServSwitch Jr. product codes covered in this manual are:

SW621A-R2

SW622A-R2

SW629A-R2

TRADEMARKS USED IN THIS MANUAL

BLACK BOX and the  logo are registered trademarks, and ServSwitch and ServSwitch Jr. are trademarks, of Black Box Corporation.

Apple and Macintosh are registered trademarks of Apple Computer, Inc.

IBM, PC/AT, PS/2, RS/6000, and ThinkPad are registered trademarks, and PC/XT is a trademark, of International Business Machines Corporation.

Logitech is a trademark of Logitech, Inc.

Microsoft and Windows are registered trademarks, and IntelliMouse is a trademark, of Microsoft Corporation.

Novell and NetWare are registered trademarks of Novell Incorporated.

SGI is a registered trademark of Silicon Graphics, Inc.

Sun Microsystems is a registered trademark of Sun Microsystems, Inc. in the United States and other countries.

UNIX is a registered trademark of UNIX System Laboratories, Inc.

Any other trademarks mentioned in this manual are acknowledged to be the property of the trademark owners.

**FEDERAL COMMUNICATIONS COMMISSION AND INDUSTRY CANADA
RADIO-FREQUENCY INTERFERENCE STATEMENTS**

This equipment generates, uses, and can radiate radio frequency energy and if not installed and used properly, that is, in strict accordance with the manufacturer's instructions, may cause interference to radio communication. It has been tested and found to comply with the limits for a Class A computing device in accordance with the specifications in Subpart J of Part 15 of FCC rules, which are designed to provide reasonable protection against such interference when the equipment is operated in a commercial environment. Operation of this equipment in a residential area is likely to cause interference, in which case the user at his own expense will be required to take whatever measures may be necessary to correct the interference.

Changes or modifications not expressly approved by the party responsible for compliance could void the user's authority to operate the equipment.

This digital apparatus does not exceed the Class A limits for radio noise emission from digital apparatus set out in the Radio Interference Regulation of Industry Canada.

Le présent appareil numérique n'émet pas de bruits radioélectriques dépassant les limites applicables aux appareils numériques de la classe A prescrites dans le Règlement sur le brouillage radioélectrique publié par Industrie Canada.

EUROPEAN UNION DECLARATION OF CONFORMITY

This equipment complies with the requirements of the European EMC Directive 89/336/EEC.

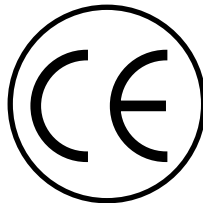

NORMAS OFICIALES MEXICANAS (NOM) ELECTRICAL SAFETY STATEMENT

INSTRUCCIONES DE SEGURIDAD

1. Todas las instrucciones de seguridad y operación deberán ser leídas antes de que el aparato eléctrico sea operado.
2. Las instrucciones de seguridad y operación deberán ser guardadas para referencia futura.
3. Todas las advertencias en el aparato eléctrico y en sus instrucciones de operación deben ser respetadas.
4. Todas las instrucciones de operación y uso deben ser seguidas.
5. El aparato eléctrico no deberá ser usado cerca del agua—por ejemplo, cerca de la tina de baño, lavabo, sótano mojado o cerca de una alberca, etc..
6. El aparato eléctrico debe ser usado únicamente con carritos o pedestales que sean recomendados por el fabricante.
7. El aparato eléctrico debe ser montado a la pared o al techo sólo como sea recomendado por el fabricante.
8. Servicio—El usuario no debe intentar dar servicio al equipo eléctrico más allá a lo descrito en las instrucciones de operación. Todo otro servicio deberá ser referido a personal de servicio calificado.
9. El aparato eléctrico debe ser situado de tal manera que su posición no interfiera su uso. La colocación del aparato eléctrico sobre una cama, sofá, alfombra o superficie similar puede bloquea la ventilación, no se debe colocar en libreros o gabinetes que impidan el flujo de aire por los orificios de ventilación.
10. El equipo eléctrico deber ser situado fuera del alcance de fuentes de calor como radiadores, registros de calor, estufas u otros aparatos (incluyendo amplificadores) que producen calor.
11. El aparato eléctrico deberá ser conectado a una fuente de poder sólo del tipo descrito en el instructivo de operación, o como se indique en el aparato.

12. Precaución debe ser tomada de tal manera que la tierra física y la polarización del equipo no sea eliminada.
13. Los cables de la fuente de poder deben ser guiados de tal manera que no sean pisados ni pellizcados por objetos colocados sobre o contra ellos, poniendo particular atención a los contactos y receptáculos donde salen del aparato.
14. El equipo eléctrico debe ser limpiado únicamente de acuerdo a las recomendaciones del fabricante.
15. En caso de existir, una antena externa deberá ser localizada lejos de las líneas de energía.
16. El cable de corriente deberá ser desconectado del cuando el equipo no sea usado por un largo periodo de tiempo.
17. Cuidado debe ser tomado de tal manera que objetos líquidos no sean derramados sobre la cubierta u orificios de ventilación.
18. Servicio por personal calificado deberá ser provisto cuando:
 - A: El cable de poder o el contacto ha sido dañado; u
 - B: Objetos han caído o líquido ha sido derramado dentro del aparato; o
 - C: El aparato ha sido expuesto a la lluvia; o
 - D: El aparato parece no operar normalmente o muestra un cambio en su desempeño; o
 - E: El aparato ha sido tirado o su cubierta ha sido dañada.

Contents

Chapter	Page
1. Specifications	8
2. Introduction	11
2.1 The Complete Package	11
2.2 Operating Features	11
2.3 The Front Panel	12
2.4 The Rear Panel	14
2.5 Cable Requirements	16
2.6 Equipment Requirements	16
3. Installation	17
3.1 Rackmounting (Optional)	17
3.2 Connecting the Keyboard, Monitor, and Mouse	17
3.3 Connecting the CPUs	18
3.4 Powering Up the System	19
3.5 Switching from the Keyboard	19
4. Operation	20
4.1 Guidelines for Using the ServSwitch Jr. with Your Equipment	20
4.1.1 CPUs	20
4.1.2 Mouse and Keyboard	20
4.1.3 Monitor	22
4.2 Keyboard-Command Summary	24
4.3 The Commands in Detail	26
4.3.1 Select a Port from the Shared Keyboard	26
4.3.2 Switch to the Next or Previous Port	26
4.3.3 Start/Stop Scanning	26
4.3.4 Perform Standard Reset	26
4.3.5 Send Null Byte	27
4.3.6 Reset Recent Windows Mouse Driver	28
4.3.7 Identify ROM	28
4.3.8 Keep Settings	28
4.3.9 Set Maximum Ports (SW622A-R2, SW629A-R2 Only)	28
4.3.10 Set Scan-Delay Time	29
4.3.11 Set Keyboard Mode	29
4.3.12 Set Keyboard Typematic	30
4.3.13 Set Mouse Mode	32
4.3.13.A Translate PS/2 to RS-232 Mouse	32
4.3.13.B Force PS/2 Wheel Mouse	32

Chapter	Page
5. Troubleshooting	33
5.1 Restoring Factory-Default Settings	33
5.2 Common Problems	34
5.2.1 CPU Doesn't Boot	34
5.2.2 Can't Switch Ports from Keyboard	35
5.2.3 Typed Characters Wrong or Missing	35
5.2.4 Can't Switch or Scan to Certain Ports	35
5.2.5 ServSwitch Jr. Scans or Switches to Empty Ports	35
5.2.6 Mouse Driver Doesn't Load	36
5.2.7 Can't Access Mouse Functions	36
5.2.8 PS/2 Mouse Gets Out of Sync	36
5.2.9 Mouse Doesn't Move Pointer/Cursor	37
5.2.10 Display is Fuzzy	37
5.2.11 Video Not Synchronized or Wrong Color	37
5.2.12 Can't Access High-Resolution Mode	38
5.2.13 CPUs Lock Up When Windows 3.x Loaded	38
5.2.14 ServSwitch Jr. Doesn't Work with Docking Station	38
5.2.15 ServSwitch Jr. Doesn't Work with Dongle-Protected Software	38
5.2.16 ServSwitch Jr. Doesn't Work with IBM ThinkPad	38
5.3 Calling Black Box	39
5.4 Shipping and Packaging	39
Appendix A: NVRAM Factory Defaults	40
Appendix B: Cable Product Codes	41
Appendix C: Rackmounting the ServSwitch Jr.	43

1. Specifications

Compliance —	CE, FCC Part 15 Subpart J Class A, IC Class/classe A
Standards —	With original Serv cabling: VGA (color or monochrome/page white) video; With original Serv cabling (minimal) or coaxial cabling (recommended): SVGA video; With coaxial cabling: XGA (color or monochrome), RS/6000, or SGI video
Interfaces —	All models: Video to monitor (pinned as VGA, standards listed above); IBM PS/2 keyboard and mouse; CPU (numbered) ports: Proprietary composite of IBM PS/2 or PC/AT keyboard, PS/2 or RS-232 mouse, and video (standards listed above); SW621A-R2, SW622A-R2 only: IBM PC/AT keyboard; EIA/TIA RS-232 pinned as TIA-574 (to optional serial mouse)
Resolution —	With original Serv cabling: Up to 1024 x 768 noninterlaced; With coaxial cabling: Up to 1600 x 1280 noninterlaced; Refer to Section 4.1.3
Refresh Rate —	Up to 100 Hz
Maximum Distance —	Depending on the CPU, monitor, and video resolution (see Section 4.1.3), up to 20 ft. (7.6 m) of original Serv cable or 50 ft. (15.2 m) of coaxial cable from the ServSwitch Jr. to any attached CPU

- User Controls** — Keyboard commands;
Front-mounted switches:
SW621A-R2: All membrane type:
 (1) for resetting the Switch, (2) for port selection;
SW622A-R2: All membrane type:
 (1) for resetting the Switch, (4) for port selection;
SW629A-R2: All pushbutton type:
 (1) for resetting the Switch, (8) for port selection
- Indicators** — All front-mounted LEDs:
SW621A-R2:
 (1) for Switch's power status,
 (2) for port selection;
SW622A-R2:
 (1) for Switch's power status,
 (4) for port selection;
SW629A-R2:
 (1) for keyboard/mouse activity,
 (8) for CPU power,
 (8) for port selection (integrated into port-selection pushbuttons)
- Connectors** — All rear-mounted:
All models:
 (1) HD15 female for VGA monitor;
 (2) 6-pin mini-DIN female:
 (1) for PS/2 keyboard, (1) for PS/2 mouse;
SW621A-R2:
 (1) 5-pin DIN female for PC/AT keyboard;
 (1) DB9 male for serial mouse;
 (2) numbered DB25 female for CPUs;
SW622A-R2:
 (1) 5-pin DIN female for PC/AT keyboard;
 (1) DB9 male for serial mouse;
 (4) numbered DB25 female for CPUs;
SW629A-R2:
 (8) numbered DB25 female for CPUs;
 (1) 3.5-mm barrel jack for optional external power

SERVSWITCH™ JR.

Power —	All models: 5 VDC at up to 1 A from the keyboard-power leads of the attached computers; SW629A-R2 only: If you attach the optional external in-line power supply PS255 (available separately): Input: 115 to 230 VAC at 50 to 60 Hz through detachable input cord into IEC 320 male inlet; Output: 5 VDC at up to 1 A through nondetachable output cord with 3.5-mm plug
Maximum Altitude —	10,000 ft. (3048 m)
Temperature Tolerance —	32 to 131°F (0 to 55°C)
Humidity Tolerance —	5 to 80% noncondensing
Enclosure —	Steel
Size —	SW621A-R2 and SW622A-R2: 1.8"H (1U) x 8.8"W x 3.5"D (4.5 x 22.4 x 8.9 cm); SW629A-R2: 1.8"H (1U) x 13.8"W x 4.9"D (4.5 x 35 x 12.4 cm)
Weight —	SW621A-R2: Net: 1.5 lb. (0.7 kg); Shipping: 2 lb. (0.9 kg); SW622A-R2: Net: 1.6 lb. (0.8 kg); Shipping: 2 lb. (0.9 kg); SW629A-R2: Net: 2.9 lb. (1.3 kg); Shipping: 3.6 lb. (1.7 kg)

2. Introduction

Thank you for choosing a ServSwitch™ Jr. Designed with your needs in mind, your new Switch will simplify your job by helping you organize your multiple-computer application. With your ServSwitch Jr., you can use one keyboard, monitor, and mouse to access as many as two, four, or eight IBM® PC compatible computers (including IBM RS/6000® computers and current SGI® computers), so you can significantly reduce your equipment overhead and end keyboard and monitor clutter.

This chapter describes everything that comes with the Switch, the external and operating features of the Switch, and the cabling you'll need for the Switch.

2.1 The Complete Package

Your ServSwitch Jr. package includes the ServSwitch Jr. unit and this manual. If anything arrived damaged, contact Black Box.

2.2 Operating Features

Some of the useful features of your ServSwitch Jr.:

- You can access up to two, four, or eight CPUs with one keyboard, monitor, and mouse.
- Support for IBM PC and RS/6000 compatible computers, as well as current SGI compatible computers.
- Microprocessor-controlled keyboard and mouse switching.
- Supports all modes of PS/2® and PC/AT® compatible keyboards.
- Mouse can be any 2-button PS/2 or serial type by Microsoft® or Logitech™, including a PS/2 “wheel mouse” such as the Microsoft IntelliMouse™.
- When you use a PS/2 type mouse, simultaneously supports CPUs with *either* PS/2 or RS-232 mouse ports.
- Support for SVGA, RS/6000, SGI, and color or monochrome XGA or VGA video at resolutions up to 1600 x 1280 noninterlaced, at refresh rates up to 100 Hz (although all video types except VGA require coaxial or special cables).
- Uses some of the attached computers' keyboard power—no external power required.
- You can select the desired CPU from keyboard or front panel.

- Front-panel LEDs show which CPU is selected.
- The units remember and restore Num Lock, Caps Lock, Scroll Lock, and keyboard mode for each CPU.
- Scan function can sequence between CPUs every 1 to 15 seconds.
- Screen-save function can turn off video after 1 to 999 seconds of inactivity.
- You can program the keyboard's typematic rate and delay.
- Custom settings for each CPU can be saved in nonvolatile memory.
- Rackmount kits are also available.

2.3 The Front Panel

The ServSwitch Jr.'s front panel features a number of LED indicators and port-selection controls. To familiarize yourself with these, refer to Figure 2-1 below and the descriptions that follow for 2- or 4-port models, or refer to Figure 2-2 on the next page and the descriptions that follow for 8-port models.

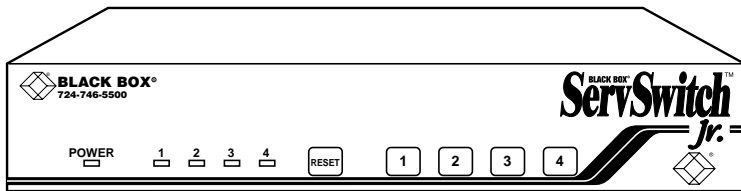

Figure 2-1. The front panel of a 4-port ServSwitch Jr. (SW622A-R2).

<i>Panel Label</i>	<i>Description</i>
POWER	Power LED: Lights to indicate that the Switch is receiving power.
[Numbered LEDs]	Port-Selection LEDs: Light if the corresponding port is currently selected.
RESET	Reset Switch: Press this membrane switch to reset the unit and reinitialize the shared keyboard and mouse; also used to restore the unit to its factory-default state.
[Numbered Switches]	Port-Selection Switches: Press any of these membrane switches to select the corresponding CPU.

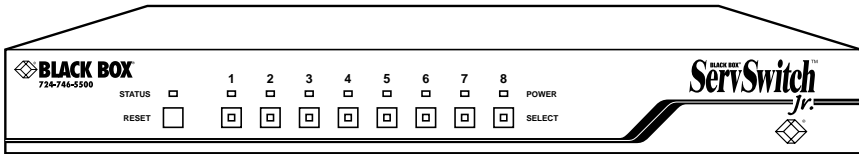

Figure 2-2. The front panel of an 8-port ServSwitch Jr. (SW629A-R2).

<i>Panel Label</i>	<i>Description</i>
STATUS	Status LED: Flickers when the Switch receives data from the attached keyboard or mouse, remains dark otherwise.
RESET	Reset Button: Press to reset the unit and reinitialize the shared keyboard and mouse; also used to restore the unit to its factory-default state.
POWER	Numbered Power LEDs: Light to indicate that the attached CPU is powered up.
SELECT	Numbered Port-Selection Buttons/LEDs: Press the buttons to select the corresponding CPU. The LEDs inside the buttons light to show that the corresponding CPU is currently selected.

2.4 The Rear Panel

All cable connections are made at the ServSwitch Jr.'s rear panel. To familiarize yourself with the Switch's connectors and what they're used for, refer to Figure 2-3 below and the descriptions that follow for 2- or 4-port models, or refer to Figure 2-4 on the next page and the descriptions that follow for 8-port models.

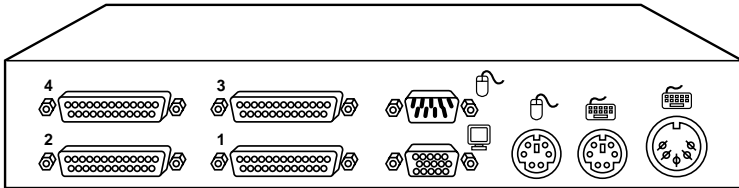

Figure 2-3. The rear panel of a 4-port ServSwitch Jr. (SW622A-R2).

<i>Panel Label</i>	<i>Connector</i>	<i>Description</i>
[Numbered Ports]	DB25 F	Connect the sharing computers to these ports with special "CPU Adapter Cables." At the Switch end, these cables have a DB25 male connector; at the other ends, they have appropriate connectors to plug into your CPUs' video, keyboard, and mouse ports. These cables take the signals that would normally be carried between the CPUs' ports and the monitor, keyboard, and mouse, and carry them between the CPUs' ports and the ServSwitch Jr. instead.
(SERIAL MOUSE)	DB9 M	If you want to use an RS-232 serial mouse, attach it directly to this port.
(VGA MONITOR)	HD15 F	Attach the shared monitor's video cable directly to this port.
(PS/2 MOUSE)	6-pin mini-DIN F	If you want to use a regular PS/2 or PS/2 wheel type mouse, attach it directly to this port.
(PS/2 KEYBOARD)	6-pin mini-DIN F	If you want to use a PS/2 type keyboard, attach it directly to this port.
(AT KEYBOARD)	5-pin DIN F	If you want to use a PC/AT type keyboard, attach it directly to this port.

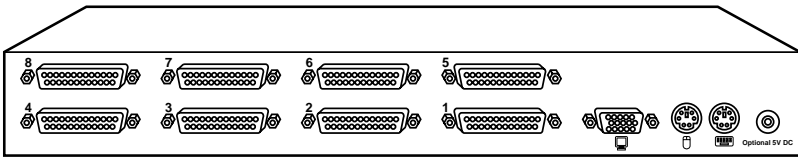





Figure 2-4. The rear panel of an 8-port ServSwitch Jr. (SW629A-R2).

<i>Panel Label</i>	<i>Connector</i>	<i>Description</i>
[Numbered Ports]	DB25 F	Connect the sharing computers to these ports with special “CPU Adapter Cables.” At the Switch end, these cables have a DB25 male connector; at the other ends, they have appropriate connectors to plug into your CPUs’ video, keyboard, and mouse ports. These cables take the signals that would normally be carried between the CPUs’ ports and the monitor, keyboard, and mouse, and carry them between the CPUs’ ports and the ServSwitch Jr. instead.
 (VGA MONITOR)	HD15 F	Attach the shared monitor’s video cable directly to this port.
 (PS/2 MOUSE)	6-pin mini-DIN F	Attach your regular PS/2 or PS/2 wheel type mouse directly to this port.
 (PS/2 KEYBOARD)	6-pin mini-DIN F	Attach your PS/2 type keyboard directly to this port.
Optional 5V DC	3.5-mm barrel jack	If you want to give the Switch more power than the attached CPUs can provide, plug the output cord of the optional PS255 external power supply into this jack.

2.5 Cable Requirements

Many switches of this type have what seems like ten million connectors on their rear panels: one for each CPU's video cable, one for each keyboard cable, and a third for each mouse cable. The potential for tangling or mismatching cables is high.

By contrast, you can connect the ServSwitch Jr. to your CPUs with one "CPU Adapter Cable" for each CPU. This single cable reaches the CPU's video-output, keyboard, and mouse ports.

The exact variety or varieties of this cable that you'll need will depend on the equipment you are connecting for your application. Refer to **Appendix B** for the available types of this cable and the corresponding product codes. Also refer to **Chapter 1** or the first Caution notice on page 18 for information about maximum cabling distances.

Lastly, you can plug the shared monitor, keyboard, and mouse directly into the ServSwitch Jr.

NOTE

To share an IBM 9515, 9517, or 9518 monitor, you will need special cabling. Call Black Box for technical support; we can give you a quote on these types of cable.

2.6 Equipment Requirements

If the CPUs you will be controlling through your ServSwitch Jr. are not all of the same type, you will have to be careful to choose a common monitor, keyboard, and mouse that adequately support all of the CPUs. For full details, see **Section 4.1**.

3. Installation



3.1 Rackmounting (Optional)

If you want to mount the ServSwitch Jr. in a 19", 23", or 24" rack, you will need a ServSwitch Rackmounting Kit. The Switch is pre-drilled to accept the Kit's rackmounting screws. See **Appendix C** for more information.

3.2 Connecting the Monitor, Keyboard, and Mouse

CAUTION!

Make sure that the monitor, keyboard, and mouse you plan to use can meet the demands of your application—see Section 4.1. Also, note that the ServSwitch Jr. does not support dongles.

1. After you verify that the ServSwitch Jr. is powered OFF, plug the HD15 male connector of the video cable from your monitor into the HD15 female port on the ServSwitch Jr.'s rear panel that's labeled with the monitor icon ().
2. If you are using a PS/2 type keyboard, plug the 6-pin mini-DIN male connector on its cable into the 6-pin mini-DIN female port on the ServSwitch Jr.'s rear panel that's labeled with the keyboard icon ().
SW621A-R2, SW622A-R2 only: If you're using a PC/AT type keyboard, plug its cable's 5-pin DIN male connector into the Switch's 5-pin DIN female port labeled with the keyboard icon.
3. If you are using a regular PS/2 or PS/2 wheel type mouse, plug the 6-pin mini-DIN male connector on its cable into the 6-pin mini-DIN female port on the ServSwitch Jr.'s rear panel that's labeled with the mouse icon ().
SW621A-R2, SW622A-R2 only: If you're using a serial mouse, plug its cable's DB9 female connector into the Switch's DB9 male port labeled with the mouse icon.

3.3 Connecting the CPUs

CPU Adapter Cables run from the ServSwitch Jr. to the keyboard port, mouse port, and video-output port of each CPU you want to directly attach to it. Different types of this cable fit the connectors on different computers (see **Appendix B**). This cable also comes in the different lengths supported by different applications (see **Section 4.1.3**).

CAUTION!

Avoid routing cable near fluorescent lights, air-conditioning compressors, or machines that may create electrical noise. Total length of original Serv cable from a ServSwitch Jr. to any given CPU should not exceed 20 feet (6.1 m). For typical equipment and video resolutions, length of coaxial cable should not exceed 20 ft. (6.1 m) from a ServSwitch Jr. to any attached device (keyboard, monitor, mouse, or CPU). However, we do provide coaxial cable in lengths up to 50 ft. (15.2 m), because some CPUs can drive and receive keyboard and mouse signals at greater distances than others. To go even farther, you might want to use Station Extenders or CAT5 KVM Extenders (see Appendix B), but please call Black Box Tech Support to discuss your application.

1. After you verify that the ServSwitch Jr. is powered OFF, plug the DB25 male composite connector of the first CPU's CPU Adapter Cable into port 1 on the Switch's rear panel. Plug the Adapter Cable you're running to the next CPU into port 2; if your Switch has more ports, plug the third CPU Adapter Cable (if necessary) into port 3, and so on.
2. Plug each CPU Adapter Cable's video-, keyboard-, and mouse-port connectors into the corresponding ports on the CPU. The CPU should be OFF when you do this; the Switch will automatically adjust to the CPU's keyboard mode when you power up the CPU. Avoid plugging CPUs into the Switch if they are already ON; if you accidentally do so, see **Section 4.3.11** to make sure the Switch is set for the proper keyboard mode.

CAUTION!

Do not attach docking stations for ThinkPad® or other portable computers, no matter what type or make, to the ServSwitch Jr. The ServSwitch Jr. does not support docking stations; your Switch system might not function properly if any are attached.

Even if you connect your ThinkPad directly (rather than through a docking station) to the keyboard, video, and mouse feeds from the ServSwitch Jr., it still won't work, because the Switch supports only "stream mode" (continuous) mouse data but the ThinkPad has to see "prompt mode" (burst-on-request) mouse data.

3.4 Powering Up the System

Power up the connected CPUs one by one, giving each one time to boot completely before turning ON the next one. (After you turn ON the first CPU, the ServSwitch Jr. itself will begin operating; it gets its power from the CPUs and has no ON/OFF switch.) The Switch emulates all keyboard and mouse functions for automatic boot-up, although you might have to issue the Mode command **Mn** (see **Section 4.3.11**) to get proper keyboard communication.

SW629A-R2 only: If your attached computers don't provide enough power on their keyboard ports for the 8-port ServSwitch Jr. to consistently operate properly, you can plug in an optional power supply (our product code PS255, available separately). To do this, first plug the power supply's output cord into the barrel jack on the back of the Switch. Then run an input cord from the power supply's IEC 320 male inlet to an AC wall jack. The Switch should begin operating immediately.

3.5 Switching from the Keyboard

Your ServSwitch Jr. is now ready for operation using its default settings. To take full advantage of the Switch's features, refer to **Chapter 4**, which gives detailed information about each of the Switch commands, describing each command's function and keystroke sequence. For your convenience, this information is summarized in **Section 4.2**. To begin switching immediately, however, just press and release your keyboard's left Control key ([Ctrl]), then—within the next two seconds—type in your desired port number with the regular number keys (not the numeric keypad).

4. Operation

The first part of this chapter, **Section 4.1**, gives you some guidelines that you should follow to make sure your ServSwitch Jr. works properly with your equipment. **Section 4.2** summarizes the ServSwitch Jr.'s keyboard commands, and **Section 4.3** describes these commands in detail.

NOTES

To start any ServSwitch Jr. keyboard command, you must press and release the left Control key ([Ctrl]). Pressing and releasing [Ctrl] cues the Switch to expect command characters from the keyboard. You then have two seconds in which to start entering a valid command. If no command is begun within two seconds or if an invalid command is entered, the Switch aborts the command.

When entering commands that contain numbers or math symbols, use only the numeral keys located at the top of your alphanumeric keyboard. Numbers and symbols entered from the numeric keypad to the right will not be recognized as valid.

4.1 Guidelines for Using the ServSwitch Jr. with Your Equipment

4.1.1 CPUs

Use only IBM PC/AT or PS/2 or 100% compatible machines. The ServSwitch Jr. does not support IBM PC/XT™ or compatible machines. It also does not support machines that output CGA or EGA video. SGI machines must output the current type of SGI video on 13W3 connectors or standard VGA video on HD15 connectors.

4.1.2 MOUSE AND KEYBOARD

When you power up your ServSwitch Jr. system, make sure that your CPUs, mouse, and keyboard are properly cabled to the ServSwitch Jr. When you boot up the CPUs, the ServSwitch Jr. should start operating automatically. Unless it's absolutely necessary, don't disconnect and reconnect the mouse or keyboard from a ServSwitch Jr. while the Switch is ON; if you have to do this, issue the Reset command ([Ctrl] R—see **Section 4.3.4**) after you reconnect the mouse or keyboard.

The mouse must be a 2-button PS/2 or RS-232 type mouse by Microsoft or Logitech, or a 3-button or "wheel" PS/2 mouse such as the Microsoft IntelliMouse. Use an RS-232 mouse only if *all* of your CPUs have serial mouse ports; if *any* of your CPUs have PS/2 mouse ports, use a PS/2 type mouse. This is because the Switch can do PS/2 to RS-232 translation if you send the Q command for each serial-mouse computer (see **Section 4.3.13**), but it can't translate RS-232 to PS/2.

Because the ServSwitch Jr. currently only supports “stream mode” (continuous) mouse data but the IBM ThinkPad has to handle mouse data in “prompt mode” (burst-on-request), don’t try to attach any ThinkPad computers to the Switch, either directly or through docking stations.

Use only the generic Microsoft mouse driver `MOUSE.COM`, version 4.0 at least and preferably version 9.01 or higher. If you’re running Windows® 3.x, this driver must be loaded in Windows as well as in DOS. Do not, on any of your switched CPUs, run any programs or TSRs, or enter any DOS commands, that change the settings of the mouse port after the driver has been loaded.

Although the ServSwitch Jr. resists minor transient surges that can be caused by rapidly cycling power, certain keyboards are sensitive to such transients. Because your shared keyboard’s power comes through the Switch, wait at least three seconds after powering down the Switch before powering it up again, or the keyboard might not reset correctly.

The ServSwitch Jr. is designed to support 101-, 102-, 104-, or 105-key keyboards and keyboard-scan modes 1, 2, and 3; it’s also designed to work with PC-type CPUs/keyboards that use 5-pin DIN or 6-pin mini-DIN keyboard connectors. The Switch might not work properly with keyboards that have proprietary keys or connectors or use proprietary keyboard-scan modes.

4.1.3 MONITOR

The ServSwitch Jr. is designed to support standard VGA video, including VGA monochrome (“page white”). It does not support PCs that use CGA, EGA, or proprietary versions of VGA that depart from the original specifications. Consult your PC’s manual, and if that doesn’t tell you whether or not the PC uses standard VGA, consult with the PC’s or the video card’s manufacturer.

The ServSwitch Jr. is also designed to support SVGA, although it doesn’t handle higher resolutions at longer distances as well without coaxial cabling (see the next two pages). With coaxial cables, it will also support XGA, RS/6000, and SGI video (RS/6000 and SGI require cables with 13W3 connectors—see **Appendix B**).

The ServSwitch Jr. will support SVGA (Super VGA) video, but with original Serv cables the video quality can decrease at higher resolutions and distances. Table 4-1, below, illustrates this. The distances in the table are total cable lengths measured from the CPU to the monitor.

Table 4-1. Video Quality vs. Distance for Original Serv Cables

Resolution \ Distance	5' (1.5 m)	10' (3 m)	15' (4.6 m)	20' (6.1 m)	25' (7.6 m)
640 x 480	3	3	3	3	3
800 x 600 noninterlaced	3	3	3	3	2
1024 x 768 interlaced	3	3	3	2	2
1024 x 768 noninterlaced	3	3	2	2	2
1280 x 1024 interlaced	3	2	2	2	1
1280 x 1024 noninterlaced	2	2	2	1	1
1600 x 1280 noninterlaced	2	2	1	1	1

Quality **3** = Near perfect; screen defects are not conspicuous

Quality **2** = Good to very good; images are clear; there are small reflections around text lettering depending on the color; screen defects are sometimes conspicuous

Quality **1** = Fair to poor as distance increases; images run from slightly fuzzy to badly smeared; text runs from fuzzy but readable to completely washed out

By contrast, coaxial cables (required for XGA applications, and recommended for most other applications) do much better at maintaining video quality, as shown in Table 4-2 below. (For the meaning of quality numbers **3**, **2**, and **1**, see the bottom of page 22.) As before, the distances in the table are total cable lengths measured *from the CPU to the monitor*.

Table 4-2. Video Quality vs. Distance for Coaxial Cables

Resolution \ Distance	20' (6.1 m)	30' (9.1 m)	55' (16.8 m)
640 x 480	3	3	3
800 x 600 noninterlaced	3	3	3
1024 x 768 interlaced	3	3	3
1024 x 768 noninterlaced	3	3	3
1280 x 1024 interlaced	3	3	3
1280 x 1024 noninterlaced	3	3	2
1600 x 1280 noninterlaced	3	2	1

CAUTION!

Some CPUs can't drive or receive keyboard and mouse signals across longer runs of coaxial cable. Consult with the manufacturers of your CPUs before installing this cable in lengths greater than 20 ft. (6.1 m).

For CPU-to-monitor distances over 55 feet (16.8 m), you might require different cabling or an Extender system such as our Station Extender or CAT5 KVM Extender (see **Appendix B**). Please call Black Box Technical Support to discuss your application.

One last note of caution about video: The IBM 9515, 9517, and 9518 monitors that come with some PS/2 systems are not normal VGA monitors and require special cabling in order for video to be correctly sized and synchronized. Call Black Box for technical support if you want to use one of these monitors.

4.2 Keyboard-Command Summary

Table 4-3 on this page and the next page summarizes the commands that can be sent to the ServSwitch Jr. To enter any command at the shared keyboard, first press and release the left Control key, represented by “[Ctrl].” (This cues the Switch to look for commands from the keyboard.) Then enter the command followed by any arguments you wish to specify (the port number, for example).

Letter commands are not case-sensitive; they are all shown in uppercase for clarity only.

When you enter numeric commands or arguments, use only the numbered keys at the top of your alphanumeric keyboard. Numbers entered from the numeric keypad to the right will not be recognized as valid commands.

All of these commands have a two-second timeout between characters. This means that if you begin entering a command, but you stop for more than two seconds at any time before you type the final character, the command is aborted and the ServSwitch Jr. returns to normal operation. This keeps the Switch from getting stuck waiting for you to finish the command.

The [Ctrl] character is always passed through to the CPU. The command characters and operands, however, are absorbed by the ServSwitch Jr. and are not sent to the CPU.

Many of these commands have factory-default values (see **Appendix A**) that can be reloaded if your Switch becomes badly misconfigured; see **Section 5.1**.

Table 4-3. The ServSwitch Jr.’s Keyboard Commands

Command	Keystroke Sequence	Description
Select Port	[Ctrl] xxx (xxx = a 1- to 3-digit port number)	Connects your shared monitor, keyboard, and mouse (user station) to the specified port.
Switch to the Next Port	[Ctrl] +	Switches to the next port in sequence.
Switch to the Previous Port	[Ctrl] -	Switches to the previous port in sequence.
Start Scanning	[Ctrl] S	Turns Scan mode ON, causing the ServSwitch Jr. to start scanning sequentially from the current port through the remaining ports and then begin again at Port 1.

Command	Keystroke Sequence	Description
Stop Scanning	[Ctrl] X	Turns Scan mode OFF (the port being scanned at the time the command is entered is given access to the shared monitor, keyboard, and mouse). Note: Scan can also be stopped by entering a Select Port command.
Perform Standard Reset	[Ctrl] R	Resets and enables the keyboard and mouse. Issue this command to correct your keyboard or mouse if one of them malfunctions or gets stuck.
Send Null Byte	[Ctrl] N	Causes the ServSwitch Jr. to send a null byte to the CPU's PS/2 mouse port. Issue this command to correct the current CPU if it gets "out of sync" with the PS/2 mouse (see Section 4.3.5).
Reset Recent Windows Mouse Driver	[Ctrl] O	Sends a command to the currently selected CPU that will cause a mouse-driver reset if the CPU is running certain combinations of recent Windows OS and recent mouse driver.
Identify ROM	[Ctrl] I	Causes the ServSwitch Jr. to report the version of ROM it is using. Issue this command if you are asked to do so by a technical-support person.
Keep Settings	[Ctrl] K	Enter this command after you enter any of the five commands listed below (it saves new settings to nonvolatile memory):
Set Maximum Number of Ports	[Ctrl] Px [ENTER] (x = 2 to 7)	<i>SW622A-R2, SW629A-R2 only:</i> Tells the Switch the total number of ports to which devices are (or will be) connected. Issue this command when you're not using all of your unit's ports.
Set Scan-Delay Time	[Ctrl] Txx [ENTER] (xx = 1 to 15)	Sets the time, in seconds, that the ServSwitch Jr. will pause at each port when scanning.
Set Keyboard Mode	[Ctrl] Mx [ENTER] (x = 1, 2, or 3)	Tells the ServSwitch Jr. the keyboard mode (1, 2, or 3) of the currently selected CPU.
Set Keyboard Typematic	[Ctrl] Axxx [ENTER] (xxx = decimal value from 0 to 127)	Sets the keyboard typematic (automatic key-repeat) function of the currently selected CPU. This command works only with CPUs that have standard keyboards and CMOS that allows users to program the typematic function.
Set Mouse Mode	[Ctrl] Qx [ENTER] (x = 0, 1, or 2)	Q1 turns on PS/2 to RS-232 mouse translation for the selected CPU. Q2 forces PS/2 wheel-mouse output to the selected CPU. Q0 turns these off.

4.3 The Commands in Detail

4.3.1 SELECT A PORT FROM THE SHARED KEYBOARD

To select a port from your keyboard, press and release your keyboard's left Control key ([Ctrl]), then press the number key corresponding to the number of your desired port ([1], [2], [3], etc.). The ServSwitch Jr. will immediately switch to that port. You can always, of course, select any port by pressing its numbered button on the Switch's front panel.

4.3.2 SWITCH TO THE NEXT OR PREVIOUS PORT

From the keyboard you can go forward or backward through the ServSwitch Jr.'s ports by selecting either the next or the previous port respectively. To switch to the next port, press and release the left Control key ([Ctrl]), then press the plus key (the key at the top of the keyboard marked with [=] and [+]). To switch to the previous port, press and release [Ctrl], then press the minus key (the key at the top of the keyboard marked with [-] and [_]). The command is not case-sensitive. Do not use the [+] and [-] keys on the keyboard's numeric pad; the Switch doesn't recognize these.

4.3.3 START/STOP SCANNING

To enable scanning (switching from CPU to CPU in a continuous rotation) from the keyboard, press and release the left Control key ([Ctrl]), then press [S]. The ServSwitch Jr. will begin scanning sequentially from its currently selected port through the higher-numbered ports, then begin again at CPU Port 1. As it scans, it delays 1 to 15 seconds at each port. (This "Scan-Delay Time" is user-selectable; see **Section 4.3.10**.) To stop scanning, press and release [Ctrl], then press [X]. You can also disable scanning by entering a Select Port command. (ServSwitch Jr. letter commands are not case-sensitive: You can enter upper- or lower-case letters.)

4.3.4 PERFORM STANDARD RESET

This command, along with the commands described in the next three sections, comes in handy when certain problems arise. It will reset or refresh your shared equipment. Issue it if (a) your shared keyboard gets stuck or begins behaving oddly, (b) you need to send mouse data to a CPU that hasn't enabled the mouse (this can happen if you boot up the CPU while the ServSwitch Jr. is off or disconnected), or (c) while using a PS/2 type mouse, you unplug it, then plug it back in. To issue the Reset command, press and release the left Control key, then type [R].

If you're using a PS/2 type mouse with a DOS or Windows 3.x CPU, don't issue this command if the CPU doesn't have a mouse driver loaded—many such CPUs will crash if you send them unexpected mouse data. (CPUs running UNIX® or later versions of Windows don't have this problem.) If your shared CPU is like this, and you have chronic problems when you try to run applications that don't use the mouse but don't disable the mouse either, take these precautions:

- If you never actually use the mouse with the CPU (as would probably be the case if, for example, the CPU were a Novell® NetWare® file server), either don't plug the mouse strand of the CPU Adapter Cable into the CPU's mouse port, or don't load a mouse driver at all. If you do use the mouse, are running Windows 3.x, and sometimes exit to DOS, make sure you load a DOS mouse driver before running Windows.
- If you've loaded a DOS mouse driver and are going to use an application such as NetWare that disables the PS/2 mouse, first REM out any statements in your startup files (AUTOEXEC.BAT, etc.) that load the mouse driver, then reboot the computer to remove the mouse driver from memory. (Having the mouse driver unload itself doesn't do the job.)

4.3.5 SEND NULL BYTE (CPUS WITH PS/2 MOUSE PORTS ONLY)

PS/2 type mice send control data to CPUs in three- or four-byte increments. Sometimes, because of electronic transients, unusual power-up effects, or plugging and unplugging of cables from live equipment, the currently selected CPU in a ServSwitch Jr. system can lose one or two bytes of this control information and get "out of sync" with the shared mouse. In this situation, the mouse might seem to refuse to move the pointer or cursor, open windows for no reason, or exhibit other strange behavior. To get the CPU back in sync, send this command to tell the Switch to send a "null byte" to the CPU's PS/2 mouse port (this has no other effect than getting the CPU "caught up"). To issue the Send Null Byte command, press and release the left Control key, then type [N]. If the mouse still isn't right after you issue this command, the CPU must have been more than one byte out of sync. Issuing the command once or twice more should do the trick.

The CPU will be thrown out of sync if it has a PS/2 mouse port and it's in sync when you issue this command. Issue this command two more times to get it back in sync again. This command has no effect on CPUs that are attached to the Switch through an RS-232 mouse port.

If you have version 9.01 or higher of the Microsoft mouse driver, the CPU should never get out of sync. Contact Microsoft if you would like to upgrade your Microsoft mouse driver.

4.3.6 RESET RECENT WINDOWS MOUSE DRIVER (CPUs WITH PS/2 MOUSE PORTS ONLY)

If the currently selected CPU is running Windows NT (or possibly Windows 98 or Windows 2000, depending on your mouse-driver version) and the PS/2 mouse gets “out of sync” (see **Section 4.3.5** for an explanation of this phenomenon), you can issue this command to completely reinitialize the mouse driver. (For machines running a combination of OS and driver that support the reinitialization function, this command is usually more effective than [Ctrl] [N] for clearing up mouse problems.) To do this, press and release the left Control key, then type the letter [O] (*not* the number zero). In contrast to [Ctrl] [N], issuing [Ctrl] [O] when the mouse is in sync will have no discernible effect on the mouse. [Ctrl] [O] also has no effect on machines running a combination of OS and driver that does *not* support the reinitialization function.

4.3.7 IDENTIFY ROM

Unfortunately, as with all complex equipment, problems might arise with your ServSwitch Jr. that require the assistance of technical-support personnel. One of the things technicians might want to know when they attempt to diagnose and correct your problem is the revision level of your Switch’s ROM. This command causes the ServSwitch Jr. to send two numbers *xy* (short for its three-character “*x.y*” ROM level) to the currently selected CPU as ASCII keyboard data; these characters will be echoed back to the shared monitor if you are at some type of prompt. (You *must* be at some kind of prompt or screen capable of displaying typed-in keyboard characters, or you will not see the Switch’s response.) To issue the Identify ROM command, press and release the left Control key, then type [I].

4.3.8 KEEP SETTINGS

The Keep Settings command saves the current state of the ServSwitch Jr.’s keyboard-selectable settings to nonvolatile memory (NVRAM), where they become the new default (loaded at power-up) settings. To enter the command from your keyboard, press and release the left Control key, then type [K]. The five keyboard-selectable settings are described in the next five sections.

4.3.9 SET MAXIMUM PORTS (SW622A-R2 AND SW629A-R2 ONLY)

Use this command to tell a 4- or 8-port ServSwitch Jr. the total number of CPU ports to which computers are or will be connected. This allows the scan function to cycle correctly if you don’t have computers attached all four or all eight of the Switch’s CPU ports. To issue the Set Maximum Ports command, press and release the left Control key, type [P] followed by the total number of ports accessible to that Switch ([2] to [7]), and press [ENTER]. To save a new Maximum Ports setting, you must issue a Keep Settings command.

4.3.10 SET SCAN-DELAY TIME

Issue the Set Scan-Delay Time command to set how long, in seconds, the ServSwitch Jr. will pause at each of the CPU ports when it's scanning them. The factory-default setting is 5 seconds. To set a different delay time, press and release the left Control key, type [T] followed by the new delay time in seconds (1 to 15), and press [ENTER]. (If you issue this command with an argument of zero, the ServSwitch Jr. will set the scan-delay time to the default value most recently saved in NVRAM.) Enter the Keep Settings command after you enter this command.

4.3.11 SET KEYBOARD MODE

Keyboard “modes” are electrical signaling protocols that determine how a powered CPU and keyboard interact. A CPU and keyboard must use the same mode in order to work with each other. Of the three standard keyboard modes currently in use, mode number 2 is the one used by the vast majority of CPUs. It is also the default state of all 101-key and PS/2 keyboards. Mode 1 is used primarily by certain PS/2 CPUs. Mode 3 is used by RS/6000 CPUs, some other UNIX based computers, and certain specialized servers.

The ServSwitch Jr. supports all three of these modes: As it receives signals from one of the keyboards, it sends them to the currently selected CPU by emulating a keyboard of the appropriate mode for that CPU; as it receives signals for one of the keyboards from the currently selected or scanned CPU, it sends them to that keyboard by emulating a CPU of the appropriate mode.

Most CPUs that use keyboard mode 1 or 3 send a “mode command” to the keyboard at power-up, to put the keyboard in the proper mode. A ServSwitch Jr. can use these commands to automatically detect each such CPU's keyboard mode when you turn on the CPU *after* it has been cabled to the Switch. However, the Switch doesn't automatically save this value; unless you send it a Keep Settings command, it will forget the modes it has detected when it is powered down, then default to each port's most recently saved setting when it's powered up again.

The ServSwitch Jr. can't detect the CPU's keyboard mode if the CPU doesn't send “mode commands” (most CPUs that use mode 2 fall into this category) or if the CPU is already ON when you connect it to the Switch (it shouldn't be). In these situations, the Switch tries to use the keyboard-mode setting stored in its nonvolatile memory for that port. The factory-default is mode 2 for all ports. Send the Set Keyboard Mode command to change the keyboard mode for a port if:

- the CPU on that port uses mode 1 or 3,
- it uses mode 2, but the default setting of the port you want to connect it to has been changed, or

- you don't know which mode the CPU uses or the port is set for, but the keyboard's behavior makes you suspect that the port's setting is wrong.

To set the keyboard mode of the currently selected port on a ServSwitch Jr., press and release the left Control key, type [M], and press the numeral key of the mode number ([1], [2], or [3]). After you enter this command, enter the Keep Settings command to save the mode setting in NVRAM, so that the new setting becomes the default value (preserved during power-down and reloaded at power-up).

If most or all of the CPUs you'll be connecting to your ServSwitch Jr. system use a keyboard mode other than 2, you might want to change the defaults of their Switch ports at installation time. This is because when power outages occur, the Switch ports will return to their default keyboard mode when the power comes back on.

4.3.12 SET KEYBOARD TYPEMATIC

Most keyboards have an internal seven-bit "typematic" setting, which governs the way the keyboard responds when you hold a key down to force it to repeat. The five "low" bits of this setting represent the rate at which the key repeats; the two "high" bits represent the delay after you begin holding down the key before it begins to repeat. Sometimes a keyboard's typematic setting isn't suitable for a given operator or for a given application. To change the typematic setting of your station's shared keyboard, issue the Set Keyboard Typematic command: Press and release the left Control key, type [A] followed by the desired "typematic value," and press [ENTER]. The "typematic value" is the decimal equivalent of the binary seven-bit typematic setting: While the typematic setting = delay bits + rate bits, the typematic value = decimal delay value + decimal rate value (see Table 4-4 below and Table 4-5 on the next page). For example, to set your shared keyboard to register a key 16 times per second after the key has been held down for half a second (typematic value = 7 + 32 = 39), type [Ctrl] [A] [3] [9] [ENTER]. Enter the Keep Settings command after you enter this command.

Table 4-4. Typematic Delay

Decimal Value	Binary Bit Values	Delay Before Key Repeats
0	00[xxxxx]	1/4 second (250 ms)
32	01[xxxxx]	1/2 second (500 ms)
64	10[xxxxx]	3/4 second (750 ms)
96	11[xxxxx]	1 second (1000 ms)

Table 4-5. Typematic Rate

Decimal Value	Binary Bit Values	Repeat Rate in Keys per Second
0	[xx]00000	30
1	[xx]00001	26.7
2	[xx]00010	24
3	[xx]00011	21.8
4	[xx]00100	20
5	[xx]00101	18.5
6	[xx]00110	17.1
7	[xx]00111	16
8	[xx]01000	15
9	[xx]01001	13.3
10	[xx]01010	12
11	[xx]01011	10.9
12	[xx]01100	10
13	[xx]01101	9.2
14	[xx]01110	8.6
15	[xx]01111	8
16	[xx]10000	7.5
17	[xx]10001	6.7
18	[xx]10010	6
19	[xx]10011	5.5
20	[xx]10100	5
21	[xx]10101	4.6
22	[xx]10110	4.3
23	[xx]10111	4
24	[xx]11000	3.7
25	[xx]11001	3.3
26	[xx]11010	3
27	[xx]11011	2.7
28	[xx]11100	2.5
29	[xx]11101	2.3
30	[xx]11110	2.1
31	[xx]11111	2

4.3.13 SET MOUSE MODE

4.3.13.A *Translate PS/2 to RS-232 Mouse*

If all of the CPUs attached to your ServSwitch Jr. have PS/2 mouse ports, you can plug a PS/2 mouse into the Switch and control them all without having to reconfigure the system at all. Likewise, if all of the attached CPUs have serial mouse ports, you can control them seamlessly after plugging an RS-232 serial mouse into the Switch.

However, if some of the CPUs have PS/2 mouse ports and some have serial mouse ports, you'll need to use a PS/2 mouse and set the Switch to do PS/2 to RS-232 mouse translation for the serial-mouse CPUs. (The Switch can't perform RS-232 to PS/2 translation.) To enable mouse translation for a serial-mouse CPU, select that CPU's port, then type [Ctrl] [Q] [1] [Enter]. Enter the Keep Settings command after you enter this command.

If later you attach a computer with a PS/2 mouse port to that CPU port on the Switch, type [Ctrl] [Q] [0] [Enter] to disable mouse translation, then enter the Keep Settings command.

4.3.13.B *Force PS/2 Wheel Mouse*

If you are using a PS/2 wheel mouse with the ServSwitch Jr., you should make sure that the Switch is actually outputting mouse data in PS/2 wheel format to all of the CPUs that can actually support it. One after another, select each CPU port that has such a CPU attached, then set mouse mode to "PS/2 wheel" for that port. To do so, type [Ctrl] [Q] [2] [Enter]. Enter the Keep Settings command after you enter this command.

If later you attach a computer with a non-wheel-mouse driver to that CPU port on the Switch, type [Ctrl] [Q] [0] [Enter] to restore normal PS/2 mouse mode, then enter the Keep Settings command.

5. Troubleshooting

The first two sections of this chapter discuss some of the problems that can arise in a ServSwitch Jr. system and suggest possible causes and solutions. If the trouble you're having with the Switch is something you haven't seen before, or if the trouble seems minor, try the procedure detailed in **Section 5.1** before doing anything else. If the trouble is chronic, see **Section 5.2**.

Sections 5.3 and **5.4** discuss what's involved in calling Black Box and shipping your Switch.

CAUTION!

We strongly recommend that you avoid opening the ServSwitch Jr.'s cover. If for some reason you need to do this, be very careful to replace each screw in the same hole you took it from, because there are three different lengths of screws involved.

5.1 Restoring Factory-Default Settings

If you're having difficulty with a ServSwitch Jr., something that often helps is resetting the Switch to its factory defaults. Follow these steps *carefully*:

1. Make sure that at least one powered CPU is attached to the ServSwitch Jr. (it doesn't matter which port the CPU is connected to).
2. Press and hold the "1" (number one) button on the ServSwitch Jr.'s front panel.
3. Press and release the RESET button, then release the "1" button. The POWER LED should flash three times, and the unit should be restored to the factory-default settings listed in **Appendix A**.

Now reconfigure the Switch to your desired settings. If you're still having difficulty, refer to **Section 5.2**. If it doesn't help you to solve your problem, call Black Box for technical support.

5.2 Common Problems

5.2.1 A CPU CONNECTED TO YOUR SWITCH DOESN'T BOOT, AND YOU GET A KEYBOARD OR MOUSE ERROR

- A.** First make sure that the CPU is in fact connected to the ServSwitch Jr. and that the Switch is receiving power. (One of the Switch's numbered CPU ports must be cabled to the keyboard port of a powered CPU in order for the Switch to work properly.)
- B.** If the Switch is ON, make sure its keyboard and mouse settings are correct.
- C.** If the configuration is OK, check your cables. Tighten any loose connections. If the keyboard and mouse strands of the CPU Adapter Cable have been reversed, plug them into the proper ports.
- D.** If you don't find a cable error, try swapping in different keyboards and/or mice one at a time. If the problem goes away when you substitute a device, the old one might have gone bad.
- E.** If swapping input devices doesn't solve the problem, begin swapping your cables one at a time. If the problem goes away when you substitute a cable, the old cable is probably defective.
- F.** If swapping cables doesn't solve the problem, try plugging the CPU into a different CPU port on the Switch. If the CPU boots when it's connected to a different port, the old port is probably defective.
- G.** If swapping ports doesn't solve the problem, try plugging a known-good keyboard and mouse directly into the CPU that's having the problem. If the CPU boots, the Switch might be defective; call Black Box.
- H.** If the CPU still doesn't boot, the CPU's keyboard or mouse port (or other components) might be defective. (If the CPU's Power LED doesn't light, the fuse on the CPU's motherboard might be blown.) If you still have them, plug that CPU's original monitor, keyboard, and mouse into it and try again. If the CPU does *not* boot with its original equipment, something in the CPU is defective; call the CPU's manufacturer. If the CPU *does* boot, there is some kind of unusual mismatch between that CPU and the shared monitor, keyboard, or mouse; call Black Box for technical support.

5.2.2 YOU CAN'T SWITCH PORTS FROM THE KEYBOARD

A. Can you do *anything* from the keyboard? If not, the keyboard cable has probably come loose. Reconnect it.

B. The ServSwitch Jr. might have lost power for less than three seconds. (This can cause the keyboard to lock up.) Disconnect the keyboard and plug it back in.

C. The keyboard might simply have gotten a little off kilter. If the Switch can see the keyboard at all, try reinitializing the keyboard with the Reset command, [Ctrl] R (see **Section 4.3.4**).

D. The keyboard mode that the currently selected CPU port is set for doesn't match the mode that the CPU on that port expects. Issue the Set Keyboard Mode command to change the port's mode (see **Section 4.3.11**). Sometimes this situation can confuse the CPU or keyboard so badly that it is necessary to reboot the CPU or to reset the keyboard by unplugging it and plugging it back in.

E. For PS/2 type equipment, if the keyboard and mouse strands of the CPU cable have been reversed, plug them into the proper ports.

F. You might be using the keyboard incorrectly. Make sure to use the *left* Control key to start port-switching commands. Make sure to use the numeric keys at the top of the keyboard rather than the numeric keypad when you type in port numbers. Make sure to release the Control key before you start typing in a port number. Make sure you don't wait too long before you enter a port number. Make sure you don't accidentally hit keys such as Shift or Alt.

5.2.3 CHARACTERS THAT YOU TYPE COME UP WRONG OR MISSING

The keyboard mode that the currently selected CPU port is set for might not match the mode that the CPU on that port expects. See item D under **Section 5.2.2**.

5.2.4 YOU CAN'T SEEM TO SCAN OR SWITCH TO CERTAIN PORTS AT ALL (SW622A-R2 AND SW629A-R2 ONLY)

The Maximum Ports setting is too low. Set Maximum Ports to match the number of CPUs in your system. See **Section 4.3.9**.

5.2.5 THE SERVSWITCH JR. SCANS OR SWITCHES TO EMPTY OR NONEXISTENT PORTS (SW622A-R2 AND SW629A-R2 ONLY)

The Maximum Ports setting is too high. Set Maximum Ports to match the number of CPUs in your system. See **Section 4.3.9**.

5.2.6 YOUR MOUSE DRIVER DOESN'T LOAD

A. What type of mouse are you using? If it's an RS-232 serial mouse, see steps B and D. If it's a PS/2 mouse (either a regular type or a wheel mouse), see steps C and D. If it's a Microsoft BallPoint mouse, see step D. At the time of this writing, the ServSwitch Jr. does not support other types of mice.

B. RS-232 serial mouse: Make sure that you're using the right COM port, and that the mouse driver is looking for the correct port.

C. PS/2 or PS/2 wheel mouse: To recognize the mouse, the CPU must be directly connected to it, or indirectly connected to it through the Switch, at boot-up time. Make sure that all cables are properly seated and that the Switch is receiving power from another computer, then reboot the CPU.

D. Your mouse driver might be old or incompatible with your mouse. Try the latest version of the Microsoft mouse driver.

5.2.7 YOU CAN'T ACCESS ALL THE FUNCTIONS OF YOUR MOUSE

A. What type of mouse is it? If it is any other type than those listed as being supported in item A under **Section 5.2.6**, chances are that the ServSwitch Jr. doesn't support it.

B. If your mouse is a Microsoft BallPoint, you need the latest version of the Microsoft mouse driver.

C. If your mouse is a Logitech mouse, the Switch supports the two-button models but not the three-button models.

5.2.8 YOUR PS/2 MOUSE GETS OUT OF SYNC

Cabling might have been disturbed during mouse movement. Issue the Send Null Byte command (see **Section 4.3.5**) one, two, or three times to get the mouse back in sync. You need the latest version of the Microsoft mouse driver to stop this from happening.

5.2.9 YOUR MOUSE DOESN'T MOVE THE POINTER/CURSOR

A. What type of mouse is it? If it is any other type than those listed as being supported in item A under **Section 5.2.6**, chances are that the ServSwitch Jr. doesn't support it.

B. The mouse might not be configured properly.

C. Your mouse must be connected to the ServSwitch Jr. when the CPUs are booted and when mouse applications are run. Try exiting and re-entering your application; if this doesn't work, issue the Reset command (see **Section 4.3.4**).

5.2.10 YOUR MONITOR DISPLAY IS FUZZY

A. Check the settings of your monitor, especially the sharpness control.

B. If you can't solve the problem by changing the monitor settings, you might have run cable too far; maximum distance of original Serv cable from any CPU to the ServSwitch Jr. is 20 ft. (6.1 m)—or less, if you are using SVGA video. You might need to upgrade from original Serv cables to coaxial cables that carry the video signal better. See **Section 4.1.3** and **Appendix B**.

5.2.11 YOUR VIDEO IS NOT SYNCHRONIZED OR IS THE WRONG COLOR

A. If you are trying to use an IBM 9515, 9517, or 9518 monitor, you need special cables to carry the video correctly. Call Black Box for technical support.

B. Check the settings of your monitor, especially the sync or color controls.

C. Your monitor might not be capable of synching to the selected video resolution or frequency (refresh rate). Try a lower resolution or frequency or a more powerful monitor.

D. If the video problem is not centered on the monitor itself, check the monitor cable and the video strand of the CPU Adapter Cable. Tighten any loose connections.

E. If no cable connectors are loose, begin swapping your cables one at a time. If the problem goes away when you substitute a cable, the old cable is probably defective.

F. If swapping cables doesn't solve the problem, try plugging the CPU into a different CPU port on the ServSwitch Jr. If the problem goes away when the CPU is connected to a different port, the old port is probably defective.

5.2.12 YOUR VIDEO IS OK IN LOW-RESOLUTION MODE, BUT YOU CAN'T GET INTO HIGH-RESOLUTION MODE

A. If you're using XGA, you *must* use coaxial cables (see **Section 4.1.3** and **Appendix B**).

B. Check your video driver. It might not be set up correctly for your desired resolution.

5.2.13 ONE OR MORE OF YOUR CPUS LOCK UP WHEN YOU START WINDOWS 3.X

The usual cause of this problem is that the affected CPUs are set to load a Logitech or other type of mouse driver when Windows starts up. Set the CPU to load the generic Microsoft mouse driver instead.

5.2.14 THE SWITCH DOESN'T WORK WITH YOUR DOCKING STATION

The ServSwitch Jr. does not support docking stations for portable computers.

5.2.15 THE SWITCH DOESN'T WORK WITH YOUR DONGLE-PROTECTED SOFTWARE

The ServSwitch Jr. does not support dongles (the devices required to be inserted into the keyboard line by some software for copy protection).

5.2.16 THE SERVSWITCH JR. DOESN'T WORK WITH YOUR IBM THINKPAD

The ServSwitch Jr. supports only "stream mode" (continuous) mouse data. It doesn't support the "prompt mode" (burst-on-request) method for handling mouse data that the IBM ThinkPad uses, regardless of whether the ThinkPad is connected to the Switch directly or through a docking station (and see **Section 5.2.14**).

5.3 Calling Black Box

If you determine that your ServSwitch Jr. is malfunctioning, *do not attempt to alter or repair the unit*. It contains no user-serviceable parts (and see the Caution notice on page 33). Call Black Box Technical Support at 724-746-5500.

Before you do, make a record of the history of the problem. We will be able to provide more efficient and accurate assistance if you have a complete description, including:

- the nature and duration of the problem;
- when the problem occurs;
- the components involved in the problem;
- any particular application that, when used, appears to create the problem or make it worse; and
- the results of any testing you've already done.

5.4 Shipping and Packaging

If you need to transport or ship your ServSwitch Jr.:

- Package it carefully. We recommend that you use the original container.
- If you are shipping the Switch for repair, make sure you include the CPU Adapter Cables you're using with it. If you are returning the Switch, make sure you include its manual as well. Before you ship, contact Black Box to get a Return Authorization (RA) number.

Appendix A: NVRAM Factory Defaults

The table below shows, for the ServSwitch Jr.'s saveable options, the default values stored in nonvolatile memory (NVRAM) when the Switch is shipped from the factory. It also shows what commands or actions can change these settings for the Switch's current operating period, as well as what commands or actions can save changed settings to NVRAM, so that they become the new defaults.

Option	Factory-Default Setting	To Change	To Save Changes
Caps/Scroll/ Num Lock	Num Lock ON (fixed)	Select port, then press the corresponding button on the keyboard	Can't be saved
Scan	OFF	Type [Ctrl] S (to turn ON) or [Ctrl] X (to turn OFF)	Can't be saved
Scan-Delay Time	5 seconds	Type [Ctrl] Txx [ENTER] (xx = 1 to 15, time in seconds)	[Ctrl] K
Maximum Ports	SW622A-R2: Four SW629A-R2: Eight	Type [Ctrl] Px [ENTER] (x = 2 to 7)	[Ctrl] K
Keyboard Mode	Mode 2	Select port, then type [Ctrl] Mx (x = 1, 2, or 3)	[Ctrl] K
Keyboard Typematic	43 (delay of 1/2 second, rate of 10.9 characters per second)	Type [Ctrl] Axxx [ENTER] (xxx = 0 to 127; see Section 4.3.12)	[Ctrl] K
PS/2 to RS-232 Mouse Translation	0 (OFF) for each computer	Select port, then type [Ctrl] 1 [ENTER] to turn ON or [Ctrl] 0 [ENTER] to turn OFF	[Ctrl] K

Appendix B: Cable Product Codes

The tables below list the product codes for all the types of CPU Adapter Cables we currently offer for use with the ServSwitch Jr. For these cables, xxx's are shown in place of the last three digits of the product code because the cables come in several stock lengths. For standard CPU Adapter Cables, these last three digits can be "005," "010," or "020" for 5-foot (1.5-m), 10-foot (3-m) or 20-foot (6.1-m) cables respectively. For coaxial CPU Adapter Cables, these last three digits can be "005," "010," "020," "035," or "050" for 5-foot (1.5-m), 10-foot (3-m), 20-foot (6.1-m), 35-foot (10.7-m), and 50-foot (15.2-m) cables respectively.

You'll also see the product codes for the Station Extender and CAT5 KVM Extender equipment listed on the next page. Depending on your equipment and the video resolution you're using, you might be able to use one of the Extender types to connect the ServSwitch Jr. to a CPU or a monitor/keyboard/mouse station as much as 1000 ft. (300 m) away.

If your monitor/keyboard/mouse-sharing system has cabling requirements that can't be met by what you see here, call Black Box for a possible quote on custom cables or adapters.

Standard CPU Adapter Cables:

Video Type (Connector on Cable)	Keyboard Type (Connector on Cable)	Mouse Type (Connector on Cable)	Product Code
VGA (HD15 male)	IBM PC/AT (5-pin DIN male)	Serial RS-232 (DB9 female)	EHN048-0xxx
VGA (HD15 male)	IBM PS/2 (6-pin mini-DIN male)	PS/2 (6-pin mini-DIN male)	EHN051-0xxx

Coaxial CPU Adapter Cables:

Video Type (Connector on Cable)	Keyboard Types	Mouse Types	Product Code
VGA (HD15 male)	IBM PC/AT and PS/2	RS-232 and PS/2	EHN282-0xxx
RS/6000 (13W3 male)	IBM PS/2 (6-pin mini-DIN male)	PS/2 (6-pin mini-DIN male)	EHN520-0001
SGI (13W3 male)	IBM PS/2 (6-pin mini-DIN male)	PS/2 (6-pin mini-DIN male)	EHN500-0xxx

Station Extenders:

CPU to ServSwitch Jr. (RS-232 Mouse): AC254A

ServSwitch Jr. to Station (RS-232 Mouse): AC255A

CPU to ServSwitch Jr. (PS/2 Style Mouse): AC257A

ServSwitch Jr. to Station (PS/2 Style Mouse): AC258A

Station-Extender Cables: EHN250-0zzz, where “zzz” = 050, 100, 150, or 200

CAT5 KVM Extenders (Kits include local and remote modules and interconnecting cables):

Single-Access Kit (remote user station only): ACU1001A

Dual-Access Kit (local and remote user stations contend): ACU1009A

AT→PS/2 Mouse Ghost (for PC/AT connections to the Extender): AC244A

Keyboard Adapter (for PC/AT connections to the Extender): FA212

Appendix C: Rackmounting the ServSwitch Jr.

If you want to mount your ServSwitch Jr. in a 19", 23", or 24" rack, use the corresponding ServSwitch Rackmounting Kit: product code RMK19M, RMK23M, or RMK24M respectively for the 2- and 4-port models, or product code RMK19S, RMK23S, or RMK24S respectively for the 8-port model. Each of these Kits consists of two rackmounting "ears" and four screws. To use a Kit to mount a ServSwitch Jr., take these steps, referring to Figure C-1 below:

1. Match up the two holes in the "Switch end" of each Kit ear with the two empty screwholes on the side of the Switch, then fasten the ear to the Switch with two of the screws included with the Kit.
2. Once you've attached both ears, match the holes in the "rack end" of each ear to an appropriate set of matching holes on your equipment rack, then screw the Switch assembly to the rack using your own screws, bolts, or cage nuts (not included).

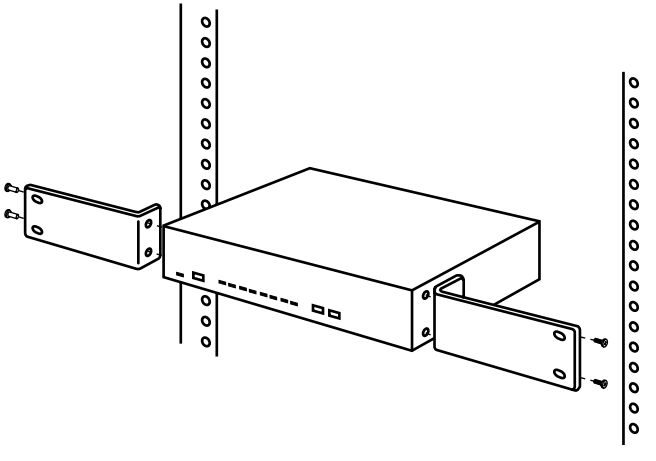

Figure C-1. Rackmount assembly.

NOTES

NOTES

NOTES