



BLACK BOX Catalogue Ltd
The Source for Connectivity



2-Port Smartview (UK Version):
SV-2
2-Port Smartview (Euro Version):
SV-2-EURO

4-Port Smartview (UK Version):
SV-4
4-Port Smartview (Euro Version):
SV-4-EURO

Remote Control for use with 4-port
versions only:
RC-1

Smartview Video Keyboard and Mouse Switch



TECHNICAL: (0118) 931 2233
SALES: (0118) 965 5100
FAX: (0118) 931 1727
ADDRESS: 15 Cradock Road, Reading, Berkshire RG2 0JT
WEB: www.blackbox.co.uk

How To Contact your Local Black Box

Italy:

Black Box Italia S.P.A

**Tel: 0227400280
Fax: 0227400219
Web Site: www.blackbox.it**

Deutschland:

Black Box Deutschland

**Tel: 0811/5541-0
Fax: 0811/5541-499
Web Site: www.blackbox-deutschland.com**

Switzerland:

Datacom Black Box Services AG

**Tel: 0554517070
Fax: 0554517075
Web Site: www.black-box.ch**

Netherlands:

Black Box Datacom BV

**Tel: 03032417799
Fax: 0302414746
Web Site: www.blackbox.nl/**

Belgium:

Black Box

**Tel: 027258550
Fax: 027259212
Web Site: www.blackbox.be**

Australia:

Black Box Catalog Australia PTY LTD

**Tel: 0398797100
Fax: 0398702955**

Brazil:

Black Box Do Brasil.

**Tel: (011) 5515-4000
Fax: (011) 5515-4002
Web Site: www.blackbox.com.br**

Canada:

Black Box Canada Corp.

**Tel: 0416-736-8000
Fax: 0416-736-7348
Web Site: www.blackbox.com**

Mexico:

Black Box De Mexico S.A. de C.V

**Tel: 05-420-0100
Fax: 05-420-0123
Web Site: www.blackbox.com.mx**

Japan:

Black Box Catalog

**Tel: 03-3820-5011
Fax: 03-3820-5010
Web Site: www.blackbox.co.jp/**

France:

Black Box Catalogue

**Tel: 0145606700
Fax: 0145606747
Web Site: www.blackbox.fr**

Spain:

Black Box Comunicaciones S.A.

**Tel: 34 91 663 0200
Fax: 34 91 661 84 35
Web Site: www.blackbox.es**

U.S.A

Black Box Corporation

**Tel: 724-746-5500
Fax: 724-746-0746
Web Site: www.blackbox.com**

Chile

Black Box Chile

**Tel: 00 562 223 8811
Fax: 00 562 225 1002
Web Site: www.Blackbox.cl**



Contents

- 1. Safety Information 6
- 2. Radio Frequency Energy 6
- 3. Approvals 7
 - 3.1. European EMC directive 89/336/EEC 7
 - 3.2. FCC Compliance Statement (United States) 7
- 4. Introduction 8
 - 4.1. Key features 8
- 5. Package contents 9
 - 5.1. Product information 9
- 6. Installation 11
 - 6.1. What you will need 11
 - 6.2. Mounting the Smartview 11
 - 6.3. Connecting your devices 12
 - 6.4. Configuring your PCs 12
 - 6.5. Configuring the Smartview 13
 - 6.6. Summary of Smartview configuration options 13
 - 6.7. Other useful installation information 15
 - 6.8. Re-enabling a disconnected PS/2 mouse 15
 - 6.9. Hot plugging the Smartview into running systems and re-enabling disconnected CPU PS/2 mouse connections 16
- 7. Using the Smartview 18
 - 7.1. Power on status 18
 - 7.2. Front panel key and remote controller 18
 - 7.3. Status display 19
 - 7.4. Keyboard hotkey control 20
 - 7.5. Mouse control 21
 - 7.6. RS232 control 21
 - 7.7. Cascading Smartviews 21
- 9. Smartview configuration options 23
 - 9.1. Screen saver time delay 23
 - 9.2. Display options 23
 - 9.3. Autoscan lock on mode and delay time 23
 - 9.4. Mouse mode and mouse switching of channels 24
 - 9.5. Keyboard hotkey combination 25
 - 9.6. Firmware functions (version query, mouse restore and reset) 26
 - 9.7. Setting a security password 26
 - 9.8. Cascade query code 27

- 9.9. Cycling between all channels or just the active channels 27
- 9.10. Exit configure mode 27
- 10. Appendix A. Cable and connector specifications 28
 - 10.1. Keyboard, monitor and mouse to Smartview 28
 - 10.2. Expansion port pin assignments (Smartview 4 port only) 29
- 11. Appendix B - Problem Solving 30



1. Safety Information

- For use in dry, oil free indoor environments only.
- Warning - live parts contained within power adapter.
- No user serviceable parts within power adapter - do not dismantle.
- Plug the power adapter into a socket outlet close to the Smartview.
- Do not use power adapter if power adapter case becomes damaged, cracked or broken or if you suspect that it is not operating properly.

If any difficulty is experienced in the installation or use of this product that you are unable to resolve, please contact Black Box Technical Support.

2. Radio Frequency Energy

Shielded cables must be used with this equipment to maintain compliance with radio frequency energy emission regulations and ensure a suitably high level of immunity to electromagnetic disturbances.

3. Approvals

3.1. European EMC directive 89/336/EEC

This equipment has been tested and found to comply with the limits for a class B computing device in accordance with the specifications in the European standard EN55022. These limits are designed to provide reasonable protection against harmful interference. This equipment generates uses and can radiate radio frequency energy and if not installed and used in accordance with the instructions may cause harmful interference to radio or television reception. However, there is no guarantee that harmful interference will not occur in a particular installation. If this equipment does cause interference to radio or television reception, which can be determined by turning the equipment on and off, the user is encouraged to correct the interference with one or more of the following measures: (a) Reorient or relocate the receiving antenna. (b) Increase the separation between the equipment and the receiver. (c) Connect the equipment to an outlet on a circuit different from that to which the receiver is connected. (d) Consult the supplier or an experienced radio / TV technician for help.

3.2. FCC Compliance Statement (United States)

This equipment generates, uses, and can radiate radio frequency energy and if not installed and used properly, that is, in strict accordance with the manufacturer's instructions, may cause interference to radio communication. It has been tested and found to comply with the limits for a class A computing device in accordance with the specifications in Subpart J of part 15 of FCC rules, which are designed to provide reasonable protection against such interference when the equipment is operated in a commercial environment. Operation of this equipment in a residential area may cause interference, in which case the user at his own expense will be required to take whatever measures may be necessary to correct the interference. Changes or modifications not expressly approved by the manufacturer could void the user's authority to operate the equipment.

Canadian Department of Communications RFI statement

This equipment does not exceed the class A limits for radio noise emissions from digital apparatus set out in the radio interference regulations of the Canadian Department of Communications.

Le présent appareil numérique n'émet pas de bruits radioélectriques dépassant les limites applicables aux appareils numériques de la classe A prescrites dans le règlement sur le brouillage radioélectriques publié par le ministère des Communications du Canada.

4. Introduction

Thank you for purchasing the Black Box Smartview. Your Smartview is a high performance keyboard, monitor and mouse sharing device which supports a wide range of PC hardware and software platforms.

4.1. Key features

- Control multiple PCs from a single keyboard, monitor and mouse.
- SmartBoot feature automatically boots all machines during power up.
- Mixed AT/PS2 keyboards and PS2/RS232 mice supported as standard.
- Can be cascaded without limitation to provide a video switching network.
- OVQ circuit ensures Optimum Video Quality even over extended distances.
- Password security prevents unauthorised use.
- Support for Microsoft IntelliMouse and other common wheel mice.
- Remote control module for convenient operation (SV4 models).
- Channel switching by front panel key, keyboard hotkey or 3 button/wheel mouse.
- Automatically restores keyboard and mouse states when channel changed.
- SV4 model can be controlled remotely via an RS232 serial port.
- Supports high bandwidth monitors at resolutions up to 1900 x 1440 at 100Hz.
- Mouse restoration functions to enable 'hot plugging' of certain systems.
- Supports keyboard modes 1,2 and 3 and mouse prompt and stream modes for maximum compatibility.

5. Package contents

- Smartview.
- Power supply suitable for your country.
- This installation guide.

5.1. Product information

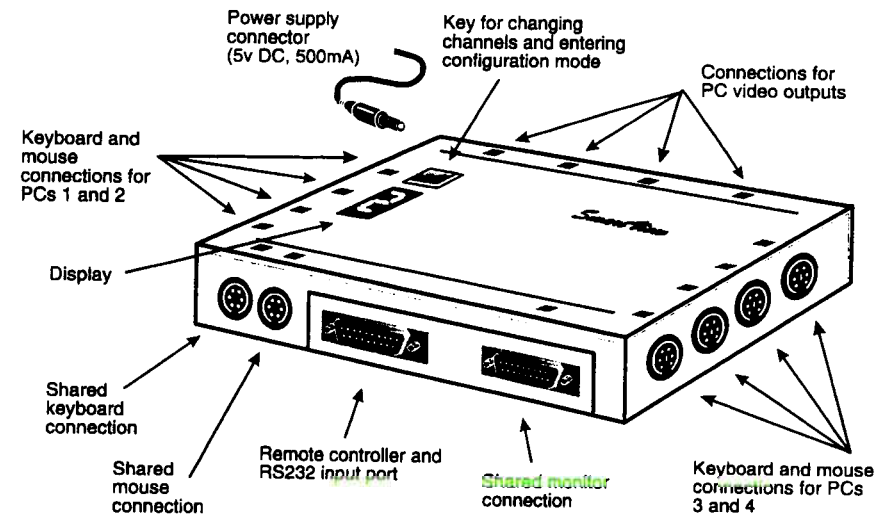

Smartview (SV4 version supporting 4 PCs)

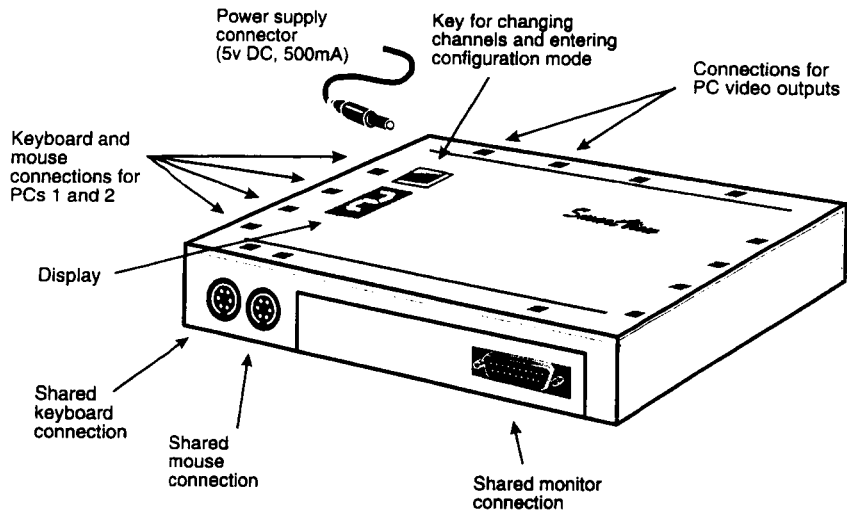

Smartview (SV2 version supporting 2 PCs)

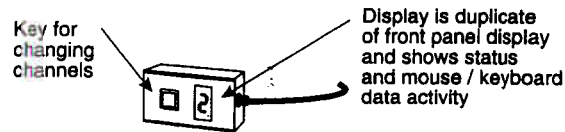

Remote control pad / display (optional accessory for 4 port models)

6. Installation

6.1. What you will need

- Cables to connect the Smartview to each of your PC keyboard, video and mouse ports. Cable specifications are given in appendix A. (You do not need to connect a mouse cable if you are not using the mouse).
- A monitor with a standard VGA/SVGA (15 pin) connector that will work when connected directly to each of your PCs. Smartview supports low and high resolution monitors.
- A standard AT or PS/2 style keyboard. If you are using an AT keyboard with a 5 pin connector you may connect this to the Smartview using a standard AT to PS/2 keyboard adapter.
- A PS/2 style two or three button Microsoft or Logitech compatible mouse or a Microsoft IntelliMouse compatible mouse. If you wish to use the mouse to switch the Smartview's channel then you will need a three button mouse or an IntelliMouse.

(The Smartview supports 'Internet Mice' that are compatible with the Microsoft IntelliMouse. These are fitted with a wheel or other scroll control and sometimes have additional buttons. Examples are: Microsoft IntelliMouse, Logitech Pilot Mouse+, Logitech MouseMan+, Genius NetMouse and Genius NetMouse Pro.)

- A suitable mouse driver for your PCs. Supported types are:
 - PS/2 or RS232 two button mouse driver (any manufacturer).
 - Microsoft mouse driver (including IntelliMouse).
 - Logitech mouse driver (including two button, three button and wheel mouse)
 - Mouse drivers that use a compatible data format to the Microsoft IntelliMouse. You may need to try these to assess their compatibility.

Use of PS/2 and RS232 style mice with the Smartview - All of the mouse connections from Smartview to PCs support either a PS/2 or an RS232 mouse. Smartview automatically converts from the PS/2 mouse commands to RS232 serial mouse commands. Serial mice types are selected by using an adapter as described in Appendix A. This adapter is the same as is shipped with Microsoft(r) auto-sensing mice. The Smartview will operate without a mouse connected if you do not wish to use one.

6.2. Mounting the Smartview

The Smartview has been designed to be used either on a desktop or mounted close to the computer system boxes which it is serving. If the Smartview is mounted away from the desktop, you may find the optional remote control keypad/display unit a useful accessory.

6.3. Connecting your devices

Ensure that the power is disconnected from the Smartview and all devices which are to be attached. Connect the shared keyboard, PS/2 mouse and monitor to the connectors at the front of the Smartview (see fig 1). Next connect each computer system unit in turn with the keyboard cable, mouse cable and video cable. Any unused computer connections can be left unconnected. To connect computers with serial mouse connections and AT style keyboard connections use the apapters supplied in the cabling pack as shown below. Alternatively, if you have chosen not to purchase the cable pack, refer to appendix A for cable specifications.

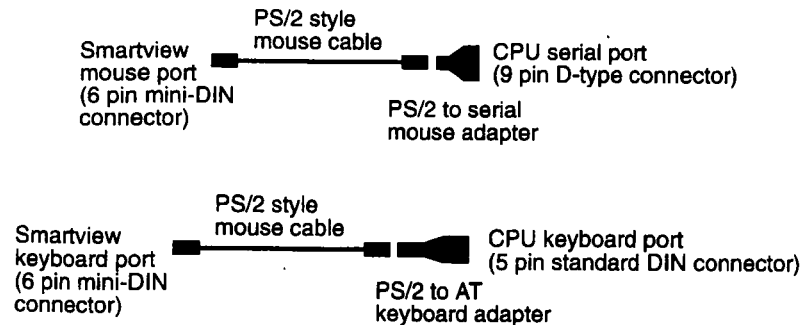

The Smartview is now ready for connection to the mains using the mains power adapter supplied. It is important to apply power to the Smartview first, then power on the monitor and each of the computers in turn. Failure to switch the Smartview and computers on in the correct order can lead to the mouse and/or keyboard not being recognised by the computers when they are switched on.

6.4. Configuring your PCs

Configure you PC in the same way that you would if your keyboard, mouse and monitor were all connected directly to your PC, but bearing in mind the following points:

- Smartview emulates Microsoft compatible serial, IntelliMouse and PS/2 mice, so ensure that your PC software is configured for a Microsoft mouse of the correct type. Refer to the list of supported drivers in section 6.1.
- Smartview supports VGA/SVGA/XGA/XGA2 type monitors, but does not support the automatic detection features available with some 'plug and play' monitors and video cards. If you have this type of video card and monitor, you should select the video mode manually instead of relying upon the automatic detection feature.

6.5. Configuring the Smartview

The Smartview is supplied pre-configured with factory defaults which are suitable for most applications. There are a number of more advanced features and functions which can be set by the user. These are stored in the Smartview's EEPROM memory and are retained when the power is disconnected.

The options may be changed whilst the Smartview is in configure mode. You may enter configure mode at initial power on or whilst the Smartview is running:

6.5.1. To enter configure mode at power on:

Switch off all the attached PCs and the Smartview. Hold down the SELECT key whilst powering on the Smartview. Do not release the key until the Smartview displays 'C' to show that it has entered configure mode.

6.5.2. To enter configure mode whilst the Smartview is running:

Hold down the SELECT key for 5 seconds until the front panel display shows 'C'.

In configure mode, options are entered by typing a letter followed by a number followed by (return). Use ESC to abort the entry of an option. The Smartview will remain in configure mode until you type 'E' (return).

For example: to set hotkey option 2 type the following at the 'C' prompt

(at Smartview 'C' prompt) 

To exit configure mode type: 

6.6. Summary of Smartview configuration options

Full details of each of the configuration options and their uses are given in section 9.

- B1 - screen saver disabled (default)
- B2 - Blank screen after 1 minute of inactivity
- B3 - Blank screen after 2 minutes of inactivity
- B4 - Blank screen after 4 minutes of inactivity
- B5 - Blank screen after 8 minutes of inactivity
- B6 - Blank screen after 12 minutes of inactivity
- B7 - Blank screen after 16 minutes of inactivity
- B7 - Blank screen after 20 minutes of inactivity

- D1 - Display dot flashes to indicate activity, right handed auxiliary display (default)
- D2 - Display dot does not flash, right handed auxiliary display
- D3 - Display dot flashes to indicate activity, left handed auxiliary display
- D4 - Display dot does not flash, left handed auxiliary display

- D5 - Display dot flashes, auxiliary display port configured for monitor light module
- D6 - Display dot does not flash, auxiliary port configured for monitor light module

- L1 - Smartview locks on to active ports only during autoscanning (default)
- L2 - Smartview locks on to every port during autoscanning
- L3 - Smartview powers on in autoscan mode and locks on to active ports only
- L4 - Smartview powers on in autoscan mode and locks on to all ports

- L7 - Smartview cascade query code = AD (default)
- L8 - Smartview cascade query code = EF

- T1 - 2 seconds autoscan delay time before switching to next port (default)
- T2 - 5 seconds autoscan delay time before switching to next port
- T3 - 7 seconds autoscan delay time before switching to next port
- T4 - 10 seconds autoscan delay time before switching to next port
- T5 - 15 seconds autoscan delay time before switching to next port
- T6 - 20 seconds autoscan delay time before switching to next port
- T7 - 30 seconds autoscan delay time before switching to next port
- T8 - 60 seconds autoscan delay time before switching to next port

- U1 - Smartview channels are switchable using a 3 button mouse or IntelliMouse (default) (Smartview reports 2 button mouse mode to PCs)
- U2 - Smartview channels are not switchable using 3 button mouse or IntelliMouse (Smartview reports 2 button mouse mode to PCs)
- U3 - Smartview channels are not switchable using 3 button mouse or IntelliMouse (Smartview reports 3 button mouse mode to PCs)
- U4 - Smartview channels are switchable using 3 button mouse or IntelliMouse (Smartview reports IntelliMouse mode to PCs)
- U5 - Smartview channels are not switchable using 3 button mouse or IntelliMouse (Smartview reports IntelliMouse mode to PCs)

- U7 - Cycle between all ports when switching with 'Hotkeys + Tab' or three button mouse
- U8 - Cycle between active ports only when switching with 'Hotkeys + Tab' or three button mouse (default)

- H1 - Hotkey combination is CTRL + ALT + command key (default)
- H2 - Hotkey combination is CTRL + SHIFT + command key
- H3 - Hotkey combination is ALT + SHIFT + command key
- H4 - Hotkey combination is RIGHT ALT + command key
- H5 - Hotkey combination is LEFT ALT + RIGHT ALT + command key
- H6 - Hotkey combination is LEFT CTRL + LEFT ALT + command key
- H7 - Hotkey combination is RIGHT CTRL + RIGHT ALT + command key
- H8 - No hotkey combination enabled

- F1 - Display firmware first digit
- F2 - Display firmware second digit
- F3 - Display firmware third digit

- F5 - Restore PS/2 mouse function
- F6 - Restore IntelliMouse function
- F8 - RESET all configurations to default settings. (Display confirms with 'r').

P - Sets password - see section 9.7 for instructions.

E - Exits configure mode and returns the Smartview to normal operation mode.

6.7. Other useful installation information

PC boot up sequence - When your PCs are powered on they communicate with any attached keyboards and mice and setup parameters required by the particular operating system. It is necessary for the Smartview to be attached and powered on during this sequence so that it can give the required responses and keep track of all the modes and settings requested by each of the connected PCs.

Mouse characteristics - do not unplug a PS/2 mouse connection from a PC whilst the PC is on. Due to the design of PS/2 mice communications the mouse function on the PC will be lost and you will have to re-boot the PC to regain normal operation. Unplugging the mouse from the Smartview will also cause it to stop operating when it is plugged back in. RS232 mice can usually be unplugged and plugged back in provided that a mouse was connected when the operating system initially booted. The Smartview is fitted with a PS/2 mouse recovery system which allows you to disconnect and re-connect the shared mouse without powering down the system (although this is generally not advisable) - see section 6.8 for details.

Keyboard and mouse mode switching - The Smartview keeps a log of the keyboard and mouse mode and resolution settings requested by each of the connected PCs. These settings are automatically restored to the shared keyboard and mouse when the Smartview channel is switched thus ensuring maximum software compatibility. The keyboard num, caps and scroll lock states are an obvious example of this process.

6.8. Re-enabling a disconnected PS/2 mouse

If you disconnect the shared PS/2 mouse from the Smartview by accident during operation then the mouse operation will be lost when the mouse is plugged back in. To avoid having to reboot the entire system in this situation the Smartview is fitted with an automatic mouse recovery system.

With the PS/2 mouse disconnected, change the channel using the keypad or keyboard hotkeys. The Smartview detects that the mouse has been disconnected and triggers the automatic recovery system. Plug in the PS/2 mouse and the Smartview will re-initialise it.

6.9. Hot plugging the Smartview into running systems and re-enabling disconnected CPU PS/2 mouse connections

It is advisable to switch off the systems that are going to be connected to the Smartview before installation. However if this is not possible then most systems can be hot plugged by using the Smartview's mouse restoration functions. The keyboard connection will normally restore itself automatically.

On many PCs, mouse movement will be lost if the PS/2 mouse is unplugged and plugged back in whilst the PC is running. Mouse movement can then only be restored by rebooting the PC. This is because the mouse drivers only setup and enable the mouse when the PC is initially booted.

If you have switched off your Smartview or you are attempting to 'hot plug' it into a system that is already running, you may be able to restore lost mouse movement using the Smartview's mouse restoration functions.

Mouse restoration functions should be used with care as unpredictable results may occur if the wrong mouse type is selected. If in doubt restore the mouse by powering down the PC normally.

Standard PS/2 mouse data uses a different data format to IntelliMouse data and so two reset functions are provided on the Smartview. The type of data format expected by the PC depends upon the driver and the type of mouse that was connected when the driver was booted. The following table may be used as a guide.

Note that the mouse reset functions predict the likely mouse resolution settings but may not restore the speed or sensitivity of the mouse exactly as they were when the PC originally booted.

Type of mouse / system Connected at bootup	Driver type	Likely expected data format	Suggested restoration
PS/2	PS/2 only	PS/2	F5
PS/2	IntelliMouse	PS/2	F5
IntelliMouse / Smartview	PS/2 only	PS/2	F5
IntelliMouse / Smartview	IntelliMouse	IntelliMouse	F6

To restore lost mouse movement on a CPU connected to the Smartview:

- 1) Select the CPU that has lost its mouse movement
- 2) Press the select key on the front of the Smartview for 5 seconds until 'C' is displayed. You are now in configure mode.
- 3) To restore a PS/2 mouse connection press



Or, to restore an IntelliMouse connection press



- 4) Exit from configure mode by typing



- 5) Test the mouse movement by moving the mouse a short distance.

F5 - Restore PS/2 mouse function
F6 - Restore IntelliMouse function

7. Using the Smartview

This section explains the general operation of the Smartview. We recommend that you read this section before starting to use the product.

7.1. Power on status

At power on the Smartview selects PC number 1 and displays '1'. If a password has been set then 'P' will be displayed and the Smartview will remain locked until a valid password is entered.

7.2. Front panel key and remote controller

The front panel key is used to select which channel is currently connected to the shared keyboard, mouse and monitor. It is also used to enter configuration mode (see section 6.5). Pressing the key during normal operation will cause the next channel to be selected. For the 2 port Smartview this cycles around ports 1 and 2. For the 4 port Smartview this cycles around ports 1, 2, 3 and 4.

An optional remote controller is also available which replicates the front panel button and display, but can be located remotely from the Smartview. This is particularly useful in applications where the Smartview is located away from the desktop. The remote controller can be conveniently attached to your keyboard with a couple of Velcro strips to give instant channel information and key control.

7.3. Status display

The status display usually shows the currently selected port. If autoscan mode is selected, the segments will illuminate in sequence in a clockwise direction interspersed with a display of the currently selected channel. If Smartview has been locked, 'P' will be displayed until a valid password has been typed to unlock the unit. Data flow from the mouse or keyboard causes the dot to flash.

DISPLAY SHOWS

MEANING

Channel number displayed and dot in lower right hand corner flashes (0 indicates SmartView is disabled)



Activity on keyboard or mouse

Illuminated segment shifts clockwise with port number shown after each scan round



Auto-scan mode - scanning from channel to channel at rate as programmed by user

'P' prompt



Locked mode waiting for password to be entered

Display flashes port number

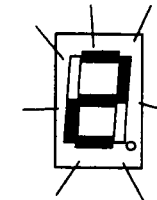

SmartView is in screen save mode - keyboard, mouse or keypad activity will re-enable the video

7.4. Keyboard hotkey control

Smartview can be conveniently controlled by selecting channel, autoscan mode or security locking from the keyboard. All of the hotkey control commands are invoked by holding down the two hotkeys and then pressing a command key. By default, the two hotkeys are 'CTRL' and 'ALT', although other combinations can be selected by reconfiguring the hotkeys (see section 9.5). Once the hotkey command has been activated you will need to release the hotkeys and the command key before a new hotkey command is accepted by the Smartview. HOTKEYS + TAB is an exception and this allows you to 'tab through' the ports by holding down the hotkeys and repeatedly pressing TAB. If the Smartview has been set to cycle between active channels (see section 9.9) then only the active channels will be selected. Otherwise the Smartview will cycle through all channels when using HOTKEYS + TAB.

The hotkey command are summarised below (note that the numbers on the numeric keypad do not form part of a valid hotkey) :

'HOTKEYS' and '1' - selects channel 1
 'HOTKEYS' and '2' - selects channel 2
 'HOTKEYS' and '3' - selects channel 3
 'HOTKEYS' and '4' - selects channel 4

'HOTKEYS' and 'TAB' - selects the next active channel if the Smartview has been set to scan active ports (see section 9.9). Selects the next numbered channel in sequence if the Smartview is set to scan all ports.

'HOTKEYS' and 'A' - selects autoscan mode where each channel is displayed for the selected time (see section 9.3). To cancel autoscan mode simply select any fixed channel either by hotkey or using the Smartview button.

'HOTKEYS' and '0' - switches off the video signal and displays 0. This will cause some monitors to go into standby mode or switch off. The video signal can be re-enabled by selecting a channel.











'HOTKEYS' and 'L' - disables the Smartview's shared keyboard and mouse and displays 0. The video signal is switched off. If a password has not been set then the Smartview can be re-enabled by selecting a channel. If a password has been set then the Smartview displays 'P' to indicate that a valid password must be entered to unlock the switch. Simply type the same key combination as was set during configuration (see section 9.8) followed by the (return) key. Note - if anyone has typed at the keyboard whilst in secure mode, it will be necessary to type (return) first to clear the invalid password, then type the valid password followed by (return) again.

Examples of common hotkey sequences (assuming CTRL + ALT hotkey option):

To select channel 2:

press    release   

To 'tab through' channels:

press    release  press 
 release  press  release   

7.5. Mouse control

The channels can conveniently be changed on Smartview software by using a three button mouse. In order to switch to the next channel simply hold down the central mouse button (the wheel mouse button on an IntelliMouse) and click on the left hand mouse button. The channel will then change. If the Smartview has been set to scan active ports then the next active channel will be selected. If it has been set to scan all ports then the next numerical channel in sequence will be selected (see section 9.9 for more details)

Mouse switching may be enabled or disabled by setting options during configuration (see section 9.4). When mouse switching is disabled the third button or wheel button state is 'passed through' the Smartview and seen by the application software.

7.6. RS232 control

Smartview can be conveniently controlled by a remote RS232 device. This interface is only fitted to Smartview 4 port products as shown in fig. 1. To select a channel the data rate of the sending device must be set to 1200 baud, 8 bits, no parity and 1 stop bit. No handshaking is used by the Smartview. Simply send the character for the channel which needs to be selected, for example ASCII '1' (hex code 31) will select channel 1, ASCII '2' (hex code 32) will select channel 2 and so on.

7.7. Cascading Smartviews

Any number of Smartview switches can be connected together to expand the number of connected computers. This can be particularly useful where clusters of computers are located some distance from each other because each unit acts as data booster and can each be up to 30 metres away from the next Smartview. The channel can be selected on remote Smartview units using an extension of the HOTKEY control function.

For example, consider a situation where two Smartview 4 port units are connected together as shown below. To connect to the computer attached to port 3 on Smartview B the user would hold down the hotkey keys then press '2' followed by '3', whilst keeping the hotkey keys pressed. This will have the effect of connecting to port 3 of the Smartview which is connected into port 2 of the first Smartview unit A.

For example to connect to port 3 on the Smartview cascaded off port 2 of your first Smartview use:

press **CTRL** **ALT** **2** release **2**

press **3** release **3** **ALT** **CTRL**

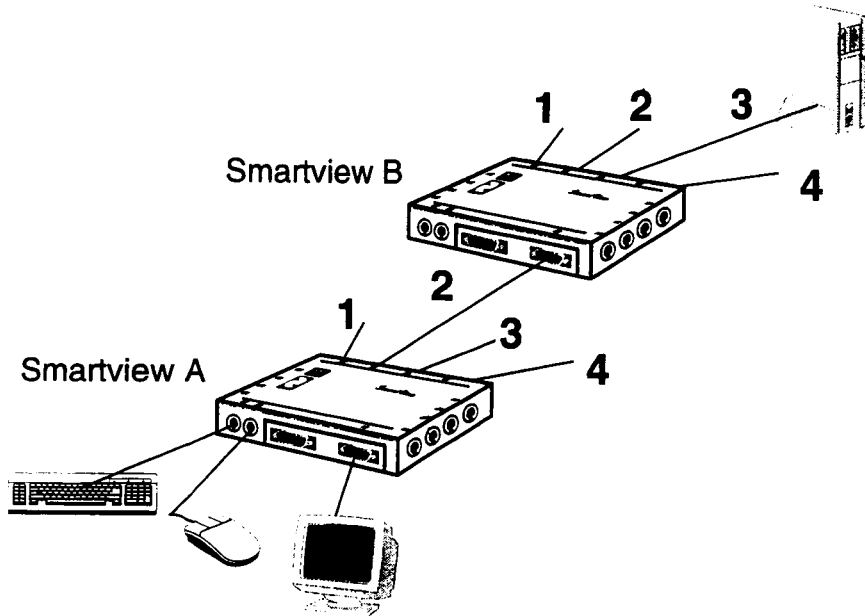

A typical cascade of two Smartview 4 port units

8. When cascading Smartviews you should ensure that all the Smartviews are set to use the same cascade query code (see section 9.8).

9. Smartview configuration options

All the options described in this section are entered in Smartview configure mode - see section 6.5 for instructions on entering configure mode.

9.1. Screen saver time delay

Smartview contains a programmable screen saver which will blank the display after the set time delay with no keyboard or mouse activity. Simply typing at the keyboard or moving the mouse will re-enable the display. The display will flash whilst the Smartview is in screen save mode.

- B1 - screen saver disabled (default)
- B2 - Blank screen after 1 minute of inactivity
- B3 - Blank screen after 2 minutes of inactivity
- B4 - Blank screen after 4 minutes of inactivity
- B5 - Blank screen after 8 minutes of inactivity
- B6 - Blank screen after 12 minutes of inactivity
- B7 - Blank screen after 16 minutes of inactivity
- B8 - Blank screen after 20 minutes of inactivity

9.2. Display options

The Smartview display has a flashing dot which will activate whenever the keyboard or mouse are used. Certain users may prefer to disable this flashing dot by setting the D2, D4 or D6 options. The remote control pad / display is designed to fit on the left or right hand side of the keyboard or monitor. Select the mode required so that the port number appears in the correct orientation. Modes D5 and D6 are special modes that support a monitor light module for use in banking and dealing room applications where the keyboard and mouse only are being switched. The monitor lights show which monitor is *currently being controlled* by the shared keyboard and mouse.

- D1 - Display dot flashes to indicate activity, right handed auxiliary display (default)
- D2 - Display dot does not flash, right handed auxiliary display
- D3 - Display dot flashes to indicate activity, left handed auxiliary display
- D4 - Display dot does not flash, left handed auxiliary display
- D5 - Display dot flashes, auxiliary display port configured for monitor light module
- D6 - Display dot does not flash, auxiliary port configured for monitor light module

9.3. Autoscan lock on mode and delay time

Smartview can be set to select each channel in turn for a period of time set by the Autoscan

delay time. Autoscan mode is entered by typing the hotkey keys together with 'A'. By default, only those channels which have a powered up computer connected to them will be scanned. Sometimes it may be desirable to scan all channels, even if the attached computer is switched off (this will simply show a blank screen when it is selected). Computers 1 and 2 will be autoscanned on a 2 port Smartview and computers 1, 2, 3 and 4 on a 4 port switch if option L2 is selected. Some applications may also require the Smartview to power on in autoscan mode. This feature can be selected using the L3 or L4 options.

- L1 - Smartview only locks on to active ports during autoscanning (default)
- L2 - Smartview locks on to every port in turn during autoscanning
- L3 - Smartview powers on in autoscan mode and locks on to active ports only
- L4 - Smartview powers on in autoscan mode and locks on to all ports

- T1 - 2 seconds autoscan delay time before switching to next port (default)
- T2 - 5 seconds autoscan delay time before switching to next port
- T3 - 7 seconds autoscan delay time before switching to next port
- T4 - 10 seconds autoscan delay time before switching to next port
- T5 - 15 seconds autoscan delay time before switching to next port
- T6 - 20 seconds autoscan delay time before switching to next port
- T7 - 30 seconds autoscan delay time before switching to next port
- T8 - 60 seconds autoscan delay time before switching to next port

note: Autoscan mode is ended simply by selecting a fixed channel using the keypad, keyboard hotkeys or the mouse.

Many modern monitors are fitted with automatic power save relays and will switch off after a few seconds if connected to an inactive PC. If you are using such a monitor you must not use the L2 feature. Constant switching on and off of your monitor's relay will eventually damage your monitor.

9.4. Mouse mode and mouse switching of channels

A three button PS/2 mouse or an IntelliMouse can be used to switch channels on the Smartview by default. To switch to the next channel, the user simply holds down the central button or wheel button and presses the left hand button to change channel. If the user does not wish to take advantage of this feature, it can be disabled by selecting U2, U3 or U5. If the third button is being used to switch the Smartview then it is not available for use with PC software although the function of an IntelliMouse wheel is not affected. Consequently in modes U1, U2 and U4 the Smartview reports to the PCs that a 2 button mouse is connected. If you wish to use the full function of a 3 button mouse or IntelliMouse for your PC software then you should select options U3 or U5.

The Smartview supports 'Internet Mice' that are compatible with the Microsoft IntelliMouse.

These are fitted with a wheel or other scroll control and sometimes have additional buttons. Examples are:

Microsoft IntelliMouse
Logitech Pilot Mouse +
Logitech MouseMan+
Genius NetMouse
Genius NetMouse Pro

You may configure your CPUs using Microsoft PS/2 or IntelliMouse drivers in any combination as required. The IntelliMouse features are supported on both PS/2 and RS232 CPU connections. When using PS/2 CPU connections, the Smartview will automatically configure itself to the type of mouse requested by the driver. If you are using RS232 CPU connections then you will need to select mouse options U4 or U5 to enable the IntelliMouse features.

- U1 - Smartview channels are switchable using a 3 button mouse or IntelliMouse (default)
(Smartview reports 2 button mouse mode to PCs)
- U2 - Smartview channels are not switchable using 3 button mouse or IntelliMouse
(Smartview reports 2 button mouse mode to PCs)
- U3 - Smartview channels are not switchable using 3 button mouse or IntelliMouse
(Smartview reports 3 button mouse mode to PCs)
- U4 - Smartview channels are switchable using 3 button mouse or IntelliMouse
(Smartview reports IntelliMouse mode to PCs)
- U5 - Smartview channels are not switchable using 3 button mouse or IntelliMouse
(Smartview reports IntelliMouse mode to PCs)

9.5. Keyboard hotkey combination

The keyboard hotkey combination is used to change a channel, set autoscan mode or secure the product (so that the password needs to be typed before it can be used again). The following keyboard hotkey combinations can be selected. These hotkey combinations are used together with the command keys to trigger the required Smartview function. The left and right shift key combination is particularly suitable for extended keyboards where additional keys can be programmed to act as a combination of other keys. Such keyboards are supplied with many Gateway 2000 computers. Programming spare keys to trigger the hotkey combination allows channels to be selected via a single key stroke.

11. Appendix B - Problem Solving

Problem:

Poor video quality with smearing fuzziness or ripple.

Action:

Use screened coaxial video cables to connect your devices to the Smartview.

Problem:

Mouse does not move cursor on screen.

Action:

Ensure that the mouse and computer are both connected to Smartview before the power is connected and ensure that the Smartview is powered on before the attached computer. Ensure that your software is configured to accept a Microsoft compatible mouse of the type that you have connected (PS/2 or RS232). If you move the mouse and the activity indicator (dot on 7 segment display) does not flash then the Smartview is not receiving data from the mouse. Check the mouse connection to the Smartview, try resetting the mouse using the reset function (section 6.8) or re-powering the Smartview. If you are attempting to connect the Smartview to a CPU with a PS/2 mouse connection that has not been powered down then you will need to use the mouse restoration functions F5 or F6 (see section 6.9).

Problem:

Keyboard does not function of functions intermittently. Num lock light does not always come on when the num lock key is pressed.

Action:

Some older keyboards were designed for use with specific computers and are not truly AT or PS/2 compatible. These are not common but if you experience problems try another keyboard.

Problem:

Mouse causes channel to change.

Action:

Some cheaper mice are not fully compatible with the Smartview and can lose data causing the channel to be changed (if mouse switching of channels is enabled). If you experience this problem then change the mouse and use a Microsoft, Logitech, IBM, Compaq or Hewlett-Packard type. Ensure that you are using a Microsoft compatible mouse driver on your PC. Some other manufacturers' drivers may switch the mouse to use a proprietary mouse data format not supported by the Smartview. If you have unplugged and re-connected a mouse to the Smartview then ensure that you reset it using the mouse reset function (see section 6.8).

Problem:

Mouse jumps around the screen after disconnecting the mouse cable or powering down the Smartview.

Action:

If you have disconnected and re-connected a CPU mouse cable or you have powered down the Smartview then the mouse data format may be out of synchronisation with that required by the PC (PS/2 or IntelliMouse). Try the 'restore IntelliMouse' function (F6) to resolve the problem or re-power the CPU.

Problem:

Mouse consistently fails to boot when using a Compaq integrated keyboard / mouse model MX11800 with the Smartview, Windows NT 4.0 and a PS/2 connection to some types of PCs.

Action:

There are three possible solutions to this problem: 1) Use a different mouse. 2) Connect the Smartview mouse connection to a serial port on the NT 4.0 unit rather than the PS/2 port. 3) Select channel 0 or a port that is not connected to an NT 4.0 box whilst NT is booting. Use the system normally once the logon screen appears.