

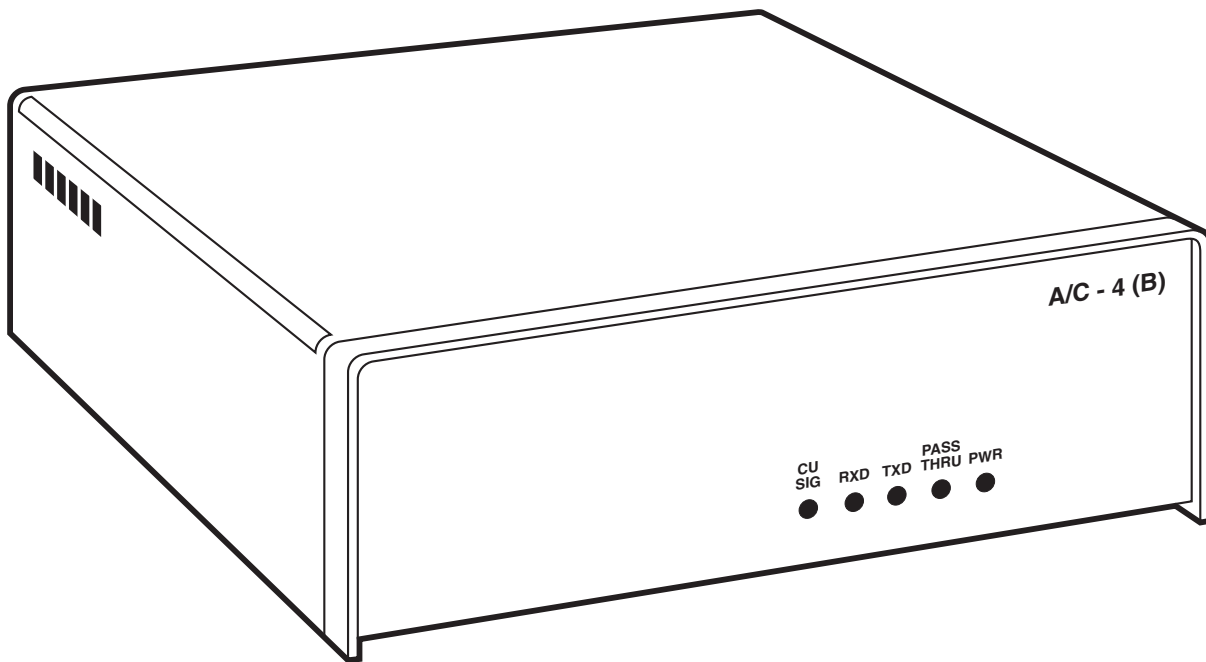

A/C-4 (B)



**CUSTOMER
SUPPORT
INFORMATION**

Order **toll-free** in the U.S. 24 hours, 7 A.M. Monday to midnight Friday: **877-877-BBOX**
FREE technical support, 24 hours a day, 7 days a week: Call **724-746-5500** or fax **724-746-0746**
Mail order: **Black Box Corporation**, 1000 Park Drive, Lawrence, PA 15055-1018
Web site: www.blackbox.com • E-mail: info@blackbox.com

**FEDERAL COMMUNICATIONS COMMISSION
RADIO FREQUENCY INTERFERENCE STATEMENT**

This equipment generates, uses, and can radiate radio frequency energy and if not installed and used properly, that is, in strict accordance with the manufacturer's instructions, may cause interference to radio communication. It has been tested and found to comply with the limits for a Class B computing device in accordance with the specifications in Subpart J of Part 15 of FCC Rules, which are designed to provide reasonable protection against such interference when the equipment is operated in a commercial environment. Operation of this equipment in a residential area is likely to cause interference, in which case the user at his own expense will be required to take whatever measures may be required to correct the interference.

Changes or modifications not expressly approved by the party responsible for compliance could void the user's authority to operate the equipment.

This digital apparatus does not exceed the Class B limits for Radio noise emission from digital apparatus set out in the Radio Interference Regulation of Industry Canada.

Le présent appareil numérique n'émet pas de bruits radioélectriques dépassant les limites applicables aux appareils numériques de la classe B prescrites dans le Règlement sur le brouillage radioélectrique édicté par Industrie Canada.

TRADEMARKS

IBM® is a registered trademark of IBM Corporation.

DEC™, VT52™, VT100™, VT101™, VT102™, VT125™, and VAX™ are trademarks of Compaq Computer Corporation.

Radio Shack® is a registered trademark of Tandy Corporation.

Qume® is a registered trademark of DTC Data Technology.

Falco FAME-II™ is a trademark of FALCO Data Products, Inc.

Tymshare® is a registered trademark of McDonnell Douglas Corporation.

Freedom® is a registered trademark of Liberty Electronics USA.

ADDS®, Regent®, and Viewpoint® are registered trademarks of Applied Digital Data Systems, Inc.

Honeywell® is a registered trademark of Honeywell.

Televideo® is a registered trademark of TeleVideo Systems, Inc.

Hazeltine® is a registered trademark of Hazeltine Corporation.

HP® and Hewlett Packard® are registered trademarks of Hewlett-Packard.

NCR® is a registered trademark of NCR Corporation.

Zenith® is a registered trademark of Zenith Electronics Corporation.

C.Itoh® is a registered trademark of C.Itoh Electronics, Inc.

Anderson Jacobsen® is a registered trademark of Anderson Jacobsen, Inc.

Beehive® is a registered trademark of Beehive International.

Lear Siegler® is a registered trademark of Lear Siegler, Inc.

Soroc™ is a trademark of Soroc Technology, Inc.

Northern Telecom® is a registered trademark of Nortel Networks.

Dasher® is a registered trademark of Data General, a Division of EMC.

HDS™ is a trademark of Gda Gesellschaft Fur Digitale.

Wyse® and WY® are registered trademarks of Wyse Technology.

Microterm® is a registered trademark of Digi-log Systems, Inc.

Displayphone® is a registered trademark of Nortel Networks.

Informer® is a registered trademark of Informer Computer Terminals, Inc.

All applied-for and registered trademarks are the property of their respective owners.

Contents

1.	INTRODUCTION.....	5
1.1	How the A/C-4 (B) Works During 3278 Emulation.....	5
1.1.1	Functions Additional to 3278 Emulation.....	6
1.1.2	Non-Session Functions.....	6
1.2	Standard and Deluxe Models.....	6
1.3	Terminal Emulators.....	6
1.3.1	Special Emulator: IBMPC.....	6
1.3.2	Special Emulator: COMPU.....	6
1.3.3	Standard Model Terminal Emulators.....	8
1.3.4	Deluxe Terminal Emulators.....	10
1.4	Passthrough Port.....	12
1.5	Personal Computer Ancillary Software.....	12
1.6	Specifications.....	12
2.	CONTROLS AND INDICATORS.....	13
2.1	Front and Rear Panels.....	13
2.1.1	Front Panel.....	13
2.1.2	Rear Panel.....	14
3.	INTERFACE SPECIFICATIONS.....	15
3.1	Serial Interface Ports.....	15
3.1.1	Serial Communications.....	15
3.1.2	Serial Interface Connections.....	15
3.1.3	The Main Port.....	15
3.1.4	The Passthrough Port.....	18
3.2	Cable Requirements.....	19
3.2.1	Coax Cable.....	19
3.2.2	RS-232 Cable.....	19
3.3	Power Requirements.....	19
4.	INSTALLATION.....	20
4.1	Equipment Requirements.....	20
4.2	Unpacking.....	20
4.3	Installation Instructions.....	20
4.3.1	Remote Applications Using Modems.....	21
4.3.2	The Passthrough Port.....	21
4.4	Initial Configuration.....	21
5.	OPERATING PROCEDURES.....	23
5.1	Summary of Operating Modes.....	23
5.1.1	Logon.....	23
5.1.2	Configuration.....	23
5.1.3	3278 Emulation.....	23
5.1.4	Passthrough.....	23
5.2	Establishing a Terminal-Host Session.....	23
5.3	Logon Mode.....	25
5.3.1	The Logon Menu.....	25
5.3.2	Logon Option: Passthrough Mode.....	25
5.3.3	Logon Option: 3278 Mode.....	25
5.3.4	Logon Option: Configuration Mode.....	26
5.3.5	Logon Option: Issue Power On Reset.....	28
5.3.6	Logon Option: Disconnect.....	28
5.4	Configuration.....	28
5.4.1	Default Terminal Type.....	28
5.4.2	Baud Rate.....	29
5.4.3	Parity.....	29

5.4.4	Data Bits.....	29
5.4.5	Flow Control.....	29
5.4.6	Display Case.....	30
5.4.7	Numeric Lock.....	30
5.4.8	Connect Password.....	31
5.4.9	Inactivity Disconnect (Min.).....	31
5.4.10	Connect Mode.....	31
5.4.11	Forced Logoff.....	31
5.4.12	Passthrough Signals.....	32
5.4.13	Flashing Asterisk.....	33
5.4.14	Typeahead.....	33
5.4.15	COMPU Echo Suppression (Deluxe Models Only).....	33
5.4.16	Banner Message.....	33
5.4.17	Exit and Save.....	34
6.	TROUBLESHOOTING.....	35
6.1	Contacting Your Supplier.....	35
6.1.1	Read the Manual.....	35
6.1.2	Have the Product Information Ready.....	35
6.1.3	Describe the Symptoms.....	35
6.1.4	Collect the Product Repair Information.....	35
6.2	Powerup Diagnostic Test Failure.....	36
6.2.1	RAM Test Failure.....	36
6.2.2	EPROM Test Failure.....	36
6.2.3	EEPROM Validity Check.....	36
6.3	Terminal ID Prompt Failure.....	36
6.4	CU SIG Indicator Failure.....	37
6.5	Erratic or Random Data on the Screen.....	37
6.6	Changing the EPROM.....	38
7.	GLOSSARY.....	39
	APPENDIX A: EBCDIC-TO-ASCII TRANSLATION TABLES.....	41
	APPENDIX B: ASCII-TO-EBCDIC DATA TRANSLATION TABLE.....	43
	APPENDIX C: STATUS LINE MESSAGES.....	45
C.1	Display Codes.....	45
C.2	Number Codes.....	47
	APPENDIX D: TERMINAL AND PC SUPPORT.....	48
D.1	ASCII Terminal Support.....	48
	APPENDIX E: EMULATION OF IBM 3278 MODEL 2 FUNCTIONS.....	54
E.1	Cursor Control.....	54
E.2	Display Fields.....	54
E.3	Auto-Skip Capability.....	54
E.4	System Indicators.....	54
E.5	Emulated 3278 Keyboard Functions.....	54
	APPENDIX F: EXTENDED FUNCTIONS.....	57
F.1	Refresh Screen.....	57
F.2	Initialize Terminal.....	57
F.3	Numeric Override.....	57
F.4	Display Status Line.....	57

APPENDIX G: TERMINAL SWITCH SETTINGS	58
G.1 ACT5A Terminal Module—Microterm ACT-5A	59
G.2 ADM11 Terminal Module—Lear Siegler ADM-11	62
G.3 ADM12 Terminal Module—Lear Siegler ADM-12	65
G.4 ADM178 Terminal Module—Lear Siegler ADM-1178	67
G.5 ADM21 Terminal Module—Lear Siegler ADM-21/22/23/24.....	70
G.6 ADM24E Terminal Module—Lear Siegler ADM-24E.....	73
G.7 ADM2D Terminal Module—Lear Siegler ADM-21.....	76
G.8 ADM3A Terminal Module—Lear Siegler ADM-3A	79
G.9 ADM3P Terminal Module—Lear Siegler ADM-3P	82
G.10 ANSI Terminal Module—ANSI Standard 3.64	85
G.11 C108 Terminal Module—HDS Concept 108/APL8.....	87
G.12 C530 Terminal Module—SOROC Challenger 530	90
G.13 COMPU Terminal Module—Computer-to-Computer Applications	95
G.14 D450 Terminal Module—Data General Dasher D400/D450	97
G.15 DG200 Terminal Module—Data General Dasher D100/200	100
G.16 DISPI Terminal Module—Northern Telecom Displayphone	102
G.17 DM20 Terminal Module—Beehive DM-20/Standard/Plus.....	105
G.18 DM5 Terminal Module—Beehive DM-1/5/10/30.....	111
G.19 DM5AB Terminal Module—Beehive DM-5A/5B	115
G.20 DM78 Terminal Module—Beehive DM-78.....	118
G.21 HP125 Terminal Module—Hewlett Packard HP-125	121
G.22 HP21 Terminal Module—Hewlett Packard HP-2621B/2641	124
G.23 HP45 Terminal Module—Hewlett Packard HP-2621A/P/2645.....	127
G.24 HZ14 Terminal Module—Hazeltime 1400/1420	130
G.25 HZ150 Terminal Module—Hazeltime 1500.....	133
G.26 HZ151 Terminal Module—Hazeltime 1510/1520	136
G.27 HZ78 Terminal Module—Hazeltime Esprit 10-78.....	139
G.28 I3101 Terminal Module—IBM 3101.....	141
G.29 I3161 Terminal Module—IBM 3161/3163	144
G.30 IBMPC Terminal Module—IBM Personal Computer	147
G.31 INF205 Terminal Module—Informer 205/207	149
G.32 SCANS Terminal Module—Tymshare Scanset	151
G.33 T4420 Terminal Module—Teletype 4420/4424	154
G.34 T5410 Terminal Module—AT&T Teletype 5410	157
G.35 T5420 Terminal Module—AT&T Teletype 5420	159
G.36 TV910 Terminal Module—Televideo TV910	162
G.37 TV910P Terminal Module—Televideo TV910+/912.....	165
G.38 TV925 Terminal Module—Televideo TV920/925/950.....	169
G.39 TV970 Terminal Module—Televideo TV970	173
G.40 VIEWC Terminal Module—ADDS Viewpoint/Color	176
G.41 VIEWP Terminal Module—ADDS Viewpoint/Regent.....	179
G.42 VIP731 Terminal Module—Honeywell VIP-7301	184
G.43 VP60 Terminal Module—ADDS Viewpoint/60	187
G.44 VP78 Terminal Module—ADDS Viewpoint/78	190
G.45 VP78C Terminal Module—ADDS Viewpoint/78 Color	193
G.46 VT100 Terminal Module—DEC VT100//VT101/VT125.....	196
G.47 VT102 Terminal Module—DEC VT102	199
G.48 VT52 Terminal Module—DEC VT52	202
G.49 VT52X Terminal Module—DEC VT52 w/out Numeric Keypad.....	205
G.50 WY100 Terminal Module—WYSE WY-100.....	207

1. Introduction

The A/C-4 (B) is a protocol converter which allows some asynchronous terminals to emulate the keyboard and display functions of an IBM® 3278 Model 2 terminal. The A/C-4 (B) connects the async devices to an IBM host through an IBM 3174, 3274, or 3276 controller.

NOTE

For IBM 3174 Control Unit support, the A/C-4 (B) requires firmware version 2.09 or above. Call your supplier for more information.

The A/C-4 (B) Standard and Deluxe models are both standalone units. The A/C-4 (B) offers the following capabilities and types.

- **Emulation** — All A/C-4 (B) models provide the same 3278 emulation functions.
- **Emulators** — The Standard model allows 13 terminal types to emulate the IBM 3278 Model 2 terminal. The Deluxe model supports approximately 60 terminal types.

- **Type** — The Standard and Deluxe models are both standalone units, as illustrated in Figure 1-1.

1.1 How the A/C-4 (B) Works During 3278 Emulation

The A/C-4 (B) connects an asynchronous (ASCII) terminal to an IBM host. 3278 Emulation allows the async terminal to emulate the keyboard and display functions of an IBM 3278 Model 2 terminal. The standard model supports 13 terminal types; the Deluxe model supports approximately 60 terminal types. The terminals supported are listed in Table 1-1 for the Standard model and Table 1-2 for the Deluxe model. 3278 key functions and other technical information are listed in **Appendixes D** through **G**.

3278 emulation may be specified as the initial connect mode, the first operation when connecting the terminal and the A/C-4 (B). If 3278 emulation is the connect mode, emulation after powerup, unless a connect password is set. In this case, emulation begins after entering the password. The logon menu is redisplayed when terminating 3278 emulation.

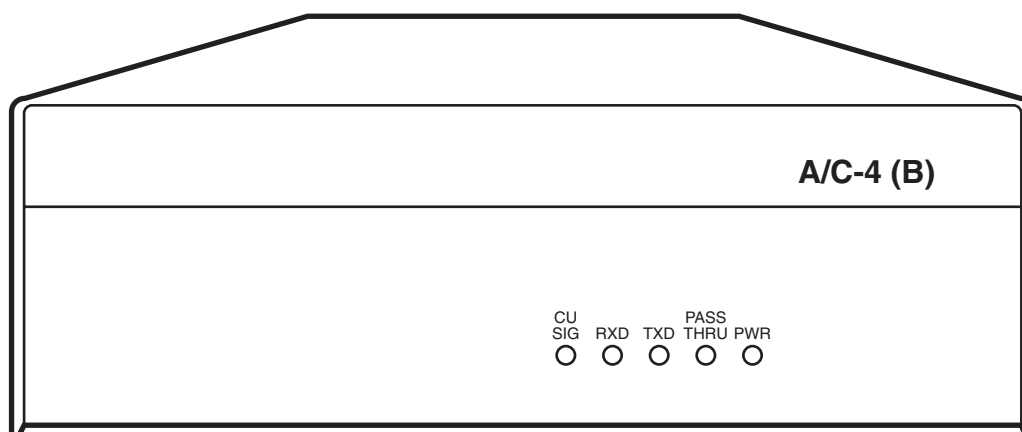

Figure 1-1. A/C-4 (B) Unit.

The factory sets logon as the initial connect mode, with the logon menu offering 3278 emulation as an option. However, 3278 emulation can be specified in the configurator as the initial connect mode.

1.1.1 FUNCTIONS ADDITIONAL TO 3278 EMULATION

In addition to emulating the IBM 3278 keyboard and terminal functions, all A/C-4 (B) models provide the following features:

- **Numeric override** — Allows non-numeric data to be input into numeric fields.
- **Refresh screen** — Redisplays the contents of the display buffer currently in use.
- **Initialize terminal** — Allows the user to return to the main prompt (Enter Terminal Type). Selecting a valid type produces the logon menu, with options for using the A/C-4 (B) (for example, to reconfigure the unit, generate a power-on reset, etc).
- **Display status line** — Sets the status line display on or off.

1.1.2 NON-SESSION FUNCTIONS

All A/C-4 (B) models also provide features which are independent of the IBM terminal-controller session:

- Selectable baud rate, parity, data length, and flow control, which are specified to match the async terminal's requirements.
- Disconnect due to terminal inactivity (0 to 30 minutes).
- Password protection when connecting the terminal and the A/C-4 (B).
- Selectable mode of operation when connecting the terminal and the A/C-4 (B): Logon Mode or 3278 emulation.
- Forced logoff option, which notifies the host application of improper logoff.
- Password protection against unauthorized access to the configurator, preventing unauthorized reconfiguration of the A/C-4 (B).

1.2 Standard and Deluxe Models

Both Standard and Deluxe models offer 3278 emulation. The only difference is that the Standard model provides emulators for approximately 13 terminal types, and the Deluxe model provides emulators for approximately 60 terminal types.

Both models also offer an optional RS-232 passthrough port, in addition to the main RS-232 port. The passthrough port permits the A/C-4 (B) to connect to another asynchronous device, such as a minicomputer, allowing communication between that device and the async terminal.

A DTE/DCE switch that allows the main RS-232 port to interface as data terminal equipment or data communications equipment. Use the DCE setting to connect directly to an async terminal (without a crossover cable). Use the DTE settings to connect through modems. Figure 1-2 shows two ways the A/C-4 (B) Standard and Deluxe models connect IBM host equipment to asynchronous devices.

1.3 Terminal Emulators

Terminal emulators provide the conversion functions and other facilities which allow an asynchronous terminal to emulate the keyboard and display functions of an IBM 3278 Model 2 terminal. The user selects the emulator which allows a particular terminal to emulate the IBM 3278. Two emulators support specialized applications: IBMPC and COMPU.

1.3.1 SPECIAL EMULATOR: IBMPC

The IBMPC emulator is used with the IBM PC and compatibles in conjunction with local-data file transfer software.

1.3.2 SPECIAL EMULATOR: COMPU

COMPU (computer to computer) simplifies the interface between and IBM host and micro-, mini-, and instrumentation computers. It is used primarily for file transfer between and asynchronous device and an IBM host. The device may be a computer, bar code reader, scanner, etc. COMPU automatically suppresses all screen-formatting commands usually generated by the A/C-4 (B), allowing the transmission of data (without command characters) between the async device and the IBM host.

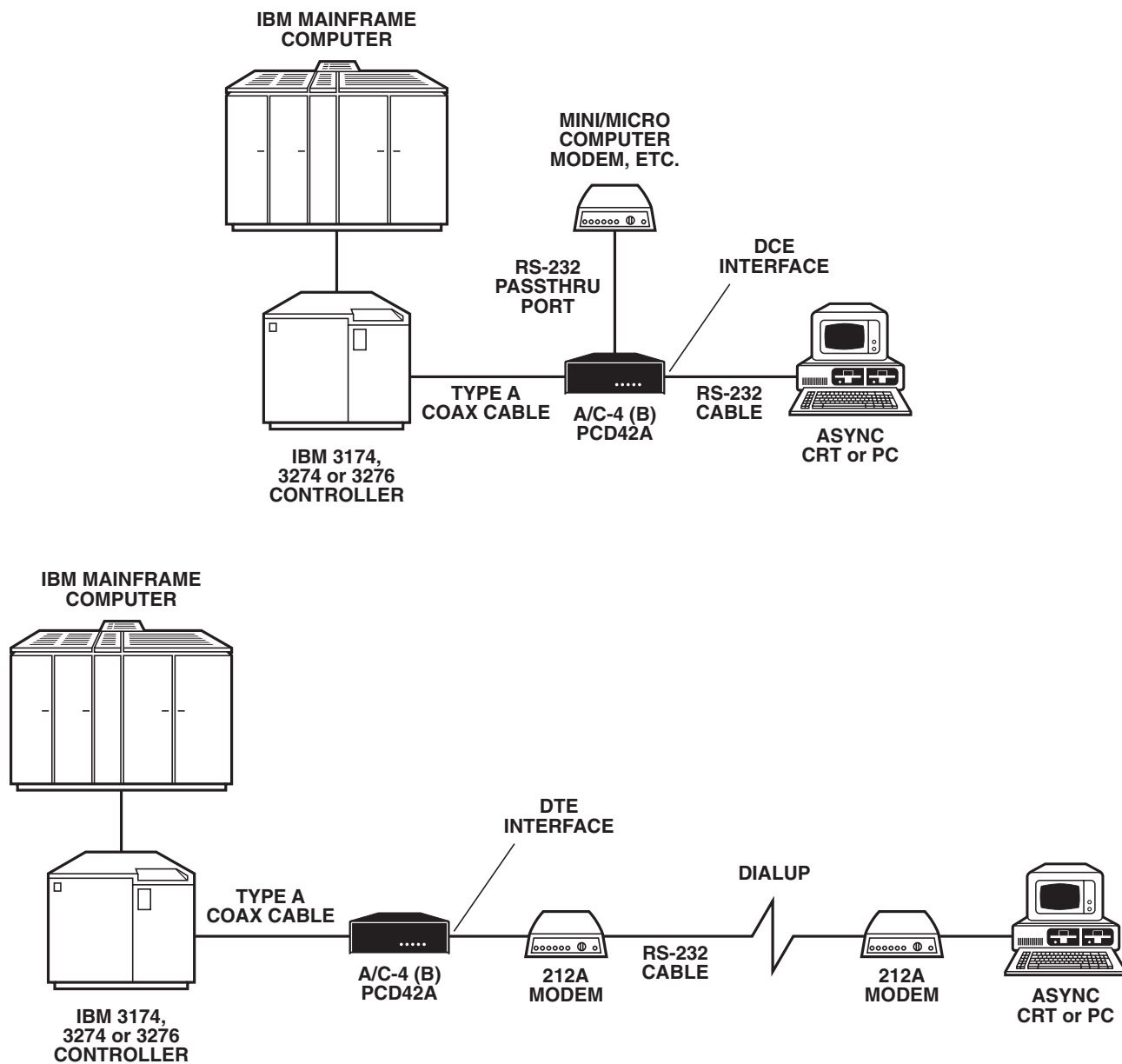

Figure 1-2. Standard and Deluxe Model Interconnections.

Data from the host is transferred through COMPU to an asynchronous device at a maximum of 1920 characters at a time. It is recommended that the data be separated into the records by displayable delimiters, allowing the async device to separate the incoming records and process them as required.

Erase/write should be specified by the host application for each write, ensuring that the buffer is cleared for the next transmission. If erase/write is not used, writes are overlaid in the buffer and data may be lost.

Data to the host is transferred through COMPU from an async device at a maximum of 1920 characters at a time. The data should be separated into records and transmitted to the host by terminating each record with an aid key, such as ENTER, PF, PA, etc. The screen should be unformatted and cleared between records to ensure data integrity.

For async devices that require suppressing the echo of input data, COMPU provides an option to suppress echo. When the option is enabled, input data is not echoed back to the async device. The option applies only to the COMPU terminal emulator.

1.3.3 STANDARD MODEL TERMINAL EMULATORS

The terminal emulators for the Standard A/C-4 (B) are listed in Table 1-1. Additional information for each emulator is given in **Appendix G**.

Table 1-1. Standard Model Terminal Emulators.

Terminal/Emulator ID	Terminals Supported
ADM21	Lear Siegler AM-21/22/23/24
ADM3A	Lear Siegler ADM-3A, Hazeltine Esprit, Qume® QVT-102, TeleVideo Personal Terminal Visual 50/200
ADM3P	Lear Siegler ADM-42/-5 (ADM-3A enhanced)
COAXIM	Coax Elimination Applications
HP45	Hewlett Packard HP-2645, HP-2612A/P
I3101	IBM 3101, Informer 301/401, Telex 310
IBM PC	IBM Personal Computer and compatibles
TV910	TeleVideo TV910, Hazeltine Esprit II, Radio Shack® DT-1
TV925	TeleVideo TV920/925/950, Datamedia DT80/3, Hazeltine Esprit III, Lear Siegler ADM-31/32, Liberty Electronics Freedom 100, Zentec Zephyr
VIEWP	ADDS Viewpoint/Regent, NCR 7901
VT100	Digital Equipment Corp. (DEC) VT100/VT101/VT125, Anderson Jacobsen AJ-520, Beehive ATL-008, C.Itoh 101, Colorgraphic MVI-100, Datamedia Colorscan 10, Datamedia DT80/1/2, Datamedia DT80/5, Direct VP800C, Falco FAME-100, Lear Siegler ADM-36, Microterm MIME-740/Ergo 4000, MVI 7, TAB 132/15, Visual 100/300/400, Zenith Z-19
VT52	Digital Equipment Corp. (DEC) VT52, Anderson Jacobsen AJ-520, Datamedia Colorscan 10, Datamedia DT80/1/2, Falco TS-1, Informer 301/401, KDE 820, Microterm MIME-2A, Microterm MIME-740/Ergo 4000, TAB 132, Visual 50/200, Zenith Z-19, Zenith ZT-1
VT52X	Digital Equipment Corp. (DEC), VT52 without numeric keypad.

1.3.4 DELUXE TERMINAL EMULATORS

Terminal emulators for the Deluxe model of A/C-4 (B) listed in Table 1-2. Additional information for each emulator is given in **Appendix G**.

Table 1-2. Deluxe Model Terminal Emulators.

Terminal Emulator ID	Terminals Supported
ACT5A	Microterm ACT5-A
ADM11	Lear Siegler ADM-11
ADM12	Lear Siegler ADM-12
ADM178	Lear Siegler ADM-1178
ADM21	Lear Siegler ADM-21/22/23/24
ADM24E	Lear Siegler ADM-24E
ADM2D	Lear Seigler ADM-21 Order Entry
ADM3A	Lear Siegler ADM-3A, Hazeltine Esprit, Qume QVT-102, TeleVideo Personal Terminal, Visual 50/200
ADM3P	Lear Siegler ADM-42/-5 (ADM-3A enhanced)
ANSI	ANSI Standard 3.64 terminals, Falco FAME™-II
C108	Human Designed Systems Concept 108/APL8
C530	Soroc Challenger 530
COAXIM	Coax Elimination Applications
COMPU	Does not format data. Passes data straight through.
D450	Data General Dasher D400/D450
DG200	Data General Dasher D100/D200, Visual 110
DISPI	Northern Telecom Displayphone
DM20	Beehive DM-20/Standard/Plus
DM5	Beehive DM-1/5/10/30 Basic
DM5AB	Beehive-5A/5B
DM78	Beehive DM-78
HP125	Hewlett Packard HP-2624/2626. HP-2382/2622m 2623
HP21	Hewlett Packard HP-2621B/2641

Table 1-2 (continued). Deluxe Model Terminal Emulators.

Terminal Emulator ID	Terminals Supported
AHP45	Hewlett Packard HP-2645, HP-2621A/P
HZ14	Hazeltine 1400/1420
HZ150	Hazeltine 1500
HZ151	Hazeltine 1510/1520
HZ78	Hazeltine Esprit 10-78, PCI 78
I3101	IBM 3101, Informer 301/401, Telex 310
I3161	IBM 3161/3163
IBMPC	IBM PC and compatibles
INF205	Informer 205/207
SCANS	Tymshare Scanset
T4420	Teletype 4420/4424, Cado
T5410	AT&T Teletype 5410
T5420	AT&T Teletype 5420
TV910	TeleVideo TV910+/912
TV925	TeleVideo TV920/925/950, Datamedia DT80/3, Hazeltine Esprit III, Lear Siegler ADM-31/32, Liberty Electronics Freedom® 100, Zentec Zephyr
TV970	TeleVideo TV970
VIEWSC	ADDS Viewpoint/Color
VIEWP	ADDS Viewpoint/Regent®, NCR® 7901
VIP731	Honeywell VIP-7301
VP60	ADDS Viewpoint/60
VP78	ADDS Viewpoint/78, NCR 7978
VP78C	ADDS Viewpoint/78 Color
VT100	Digital Equipment Corp. VT100/VT101/VT124, Anderson Jacobsen AJ-520, Beehive ATL-008, C.Itoh 101, Colorgraphic MVI-100, Datamedia Colorscan 10, Datamedia DT80/1/2, Datamedia DT80/5, Direct VP800C, Falco Frame-100, Lear Siegler ADM-36, Microterm MIME-740/Ergo 4000, MVI 7, TAB 132/15, Visual 100/300/400, Zenith® Z-19
VT102	Digital Equipment Corp. VT-102

Table 1-2 (continued). Deluxe Model Terminal Emulators.

Terminal Emulator ID	Terminals Supported
VT52	Digital Equipment Corp. VT52, Anderson Jacobsen AJ-520, Datamedia Colorscan 10, Datamedia DT80/1/2, Falco TS-1, Informer 301/401, KDE 820, Microterm MIME-2A, Microterm MIME-740/Ergo 4000, TAB 132, Visual 50/200, Zenith Z-19, Zenith ZT-1
VT52X	Digital Equipment Corp. VT-52 without numeric keypad
WY100	Wyse WY®-100

1.4 Passthrough Port

Both A/C-4 (B) models provide an RS-232 main port for connecting the A/C-4 (B) to an asynchronous device, such as a terminal or modem. They also provide a coax port for connecting to an IBM controller.

Optionally provide an additional RS-232 port for communication with an asynchronous device, such as a host computer.

The passthrough port connects an async terminal and an async host (or other async device) while the terminal is still physically connected to an IBM host through the main port. Passthrough operation allows communication between the async terminal and async host. However, the terminal can't access the IBM host during passthrough operations.

The main port and passthrough port are RS-232, serial interface ports. An explanation of serial interface equipment and the specifications for each of these ports are given in **Section 3.1**. Information about passthrough signals is given in Section 5.4.13.

1.5 Personal Computer Ancillary Software

File transfer software is available for the IBM PC and a number of compatibles for emulating the IBM 3278 Model 2 and for file transfer.

IBMPC is the terminal emulator used with file-transfer software. The IBMPC emulator displays status on the 25th line of the screen. With IBMPC, two options are not available: display status line and flashing asterisk.

1.6 Specifications

Power Connector — International Standard CEE-22 Connector

Power Consumption — 20 watts nominal

Altitude — Sea Level to 10,000 feet (3 kilometers)

Temperature — 32° to 104°F (0° to 40°C)

Relative Humidity — 2 to 95% noncondensing.

Size — 3.8"H x 11"W x 14"D
(9.7 x 27.9 x 35.5 cm)

Weight — 16 lb. (7.3 kg)

2. Controls and Indicators

The A/C-4 (B) uses a minimum number of switches and controls, facilitating use by remote operators. The A/C-4 (B) controls, indicators, switches, and connectors are described in this section.

2.1 Front and Rear Panels

The Standard and Deluxe models have the front and rear panels described below.

2.1.1 FRONT PANEL

The front panel of the A/C-4 (B) has five LED indicators, as shown in Figure 2-1.

- **CU SIG** — Steady light indicates the the A/C-4 (B) is communicating, or answering polls with the IBM Control Unit.

- **RXD** — Rapidly flashing light indicates that the A/C-4 (B) is receiving data from the terminal or modem attached to the main port.
- **TXD** — Rapidly flashing light indicates that the A/C-4 (B) is transmitting data to the terminal or modem attached to the main port.
- **PASSTHRU** — Steady light indicates that the A/C-4 (B) is in passthrough operation.
- **PWR** — Steady light indicates that the power is on.

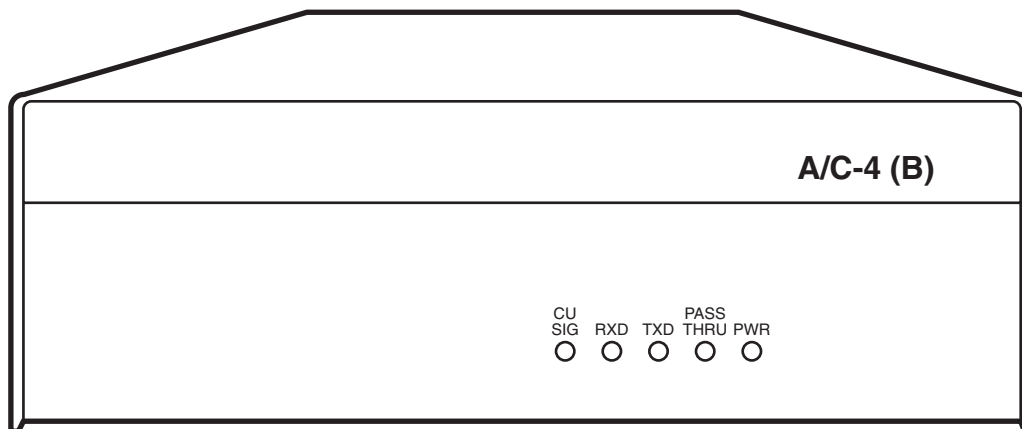

Figure 2-1. A/C-4 (B) Front Panel.

A/C-4 (B)

2.1.2 REAR PANEL

The rear panel of the A/C-4 (B) has the following connectors and switches, which are illustrated in Figure 2-2.

- **POWER Switch** — Turns power on and off. Position 1: ON, Position 0: OFF.
- **RS-232C I/O, J3 Connector** — The port for connecting a terminal or modem. Called the main port.
- **PASS THRU, J4 Connector** — The port for connecting the asynchronous host or other async input device. Called the passthrough port. Set for data terminal equipment (DTE) operation only. To connect to another DTE interface, such as a directly connected terminal, a crossover cable must be used.

- **J5 BNC Connector** — Coaxial cable connection from IBM control unit.
- **DCE/DTE Pushbutton Switch** — This switch affects only the main port. If the A/C-4 (B) communicates with a modem or other data communications equipment (DCE) type of interface, the switch on the rear panel must be in the DTE (in) position. (The button is slightly recessed). To connect the terminal directly, the switch must be in the DCE (out) position.
- **AC INPUT** — 115/230 VAC, 50/60 Hz, AC power cord connection.

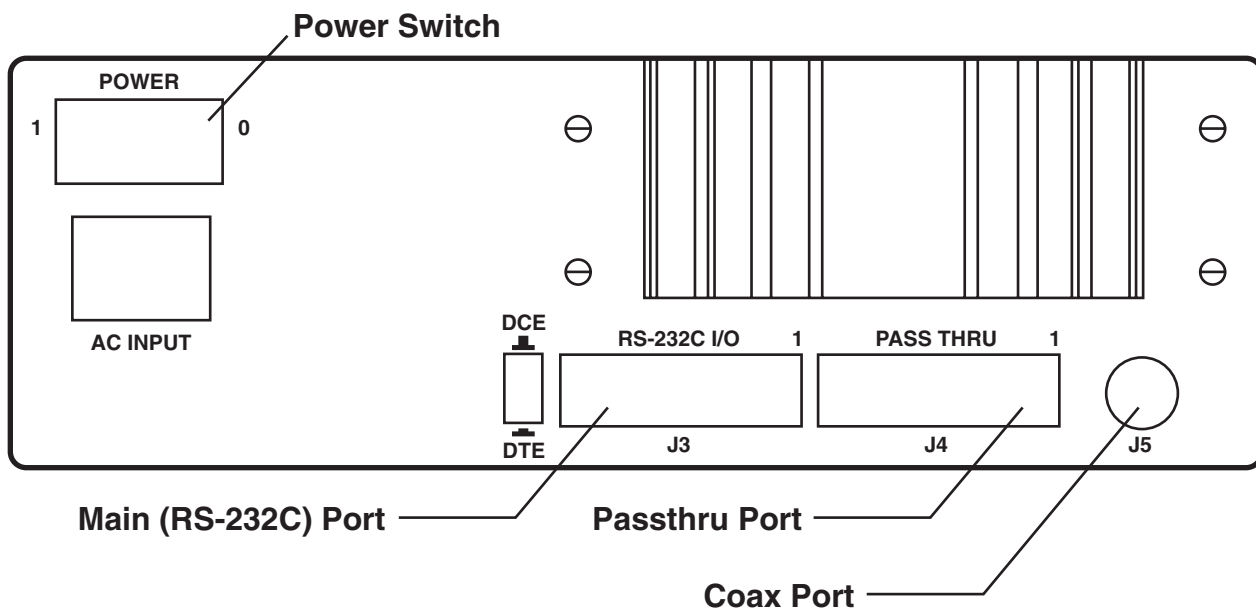

Figure 2-2. A/C-4 (B) Rear Panel.

3. Interface Specifications

This section discusses the power requirements, the port specifications, and the cable requirements for the A/C-4 (B). If you use cables not purchased from your supplier, please use the following information to determine if they are correct for use with the A/C-4 (B).

3.1 Serial Interface Ports

Both A/C-4 (B) models provide an RS-232 main port for connecting the A/C-4 (B) to an asynchronous device, such as a terminal or modem. They also provide a coax port for connecting to an IBM controller.

Both models optionally provide an additional RS-232 passthrough port for communication between an asynchronous terminal (or other async input device) and another asynchronous device, such as a host computer.

The main port and passthrough port are RS-232, serial interface ports. An explanation of serial interface equipment and the specifications for each of these ports is given below.

3.1.1 SERIAL COMMUNICATIONS

All serial interface equipment can be classified as data communications equipment (DCE) or as data terminal equipment (DTE). Modems, used in pairs with telephone line connections, as well as line drivers, are examples of DCE. Most ASCII terminals

and peripherals, such as serial printers, are classified as DTE. A DTE device is usually connected to a DCE device. When connecting two devices of the same type, a crossover cable must be used (Figure 3-2).

3.1.2 SERIAL INTERFACE CONNECTIONS

If a terminal is connected to the A/C-4 (B) without a crossover cable, the A/C-4 (B) must function as a DCE device. Therefore, the main port DCE/DTE switch on the rear panel of the standalone unit is set to DCE (out position). For remote connections using a modem or an asynchronous line driver, the A/C-4 (B) must be connected as a DTE device and the DCE/DTE switch is set to DTE (in position). The type of interface to use is explained in the operating manual for the terminal or device connected to the main port. The DTE/DCE switch configures the main port only; it does not affect the passthrough port.

The interface pins are the same for the main and passthrough ports and are illustrated in Figure 3-1. The rack system main port is configured only as DTE. A crossover cable must be used for connecting to a DTE device.

3.1.3 THE MAIN PORT

The pin configurations of the main-port interface are defined in Table 3-1 for DTE, and in Table 3-2 for the DCE.

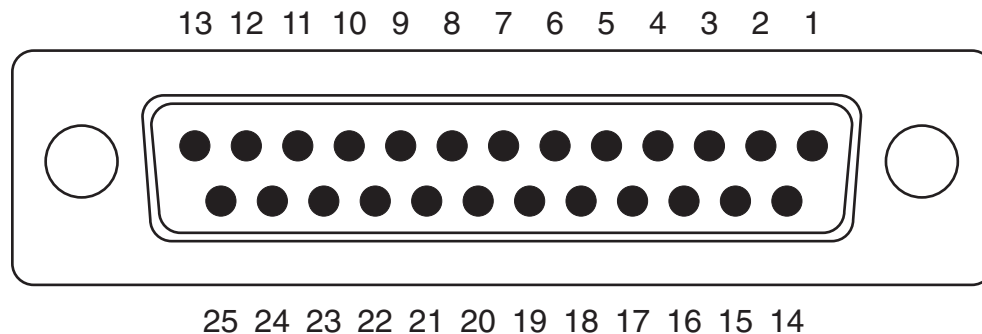

Figure 3-1. Serial Interface Pin Locations.

Table 3-1. Serial Interface Pin Locations.

Pin No.	Pin Name	In/Out	Usage
1	Frame Ground	Ground	Frame Ground
2	TXD	Output	Data Output by A/C-4 (B)
3	RXD	Input	Data Input to A/C-4 (B)
4	RTS	Output	Normally on; Turned off 1 second during disconnect (except turned off when used for flow control to stop data input to A/C-4 (B))
5	CTS	Input	Not Used
6	DSR	Input	If Off, causes A/C-4 (B) to disconnect
7	Signal Ground	Ground	Signal Ground
8	DCD	Output	Always On
9	+12V	Output	Always present
10	-12V	Output	Always present
11-19	—	—	Not used
20	DTR	Output	Normally On; Turned Off 1 second during disconnect
21-25	—	—	Not used

Table 3-2. Main Port Pin Designations for DCE.

Pin No.	Pin Name	In/Out	Usage
1	Frame Ground	Ground	Frame Ground
2	TXD	Input	Data Input to A/C-4 (B)
3	RXD	Output	Data Output by A/C-4 (B)
4	RTS	Input	Not used
5	CTS	Output	Normally on; Turned off 1 second during disconnect (except turned off when used for flow control to stop data input to A/C-4 (B))
6	DSR	Output	Normally On; Turned Off 1 second during disconnect
7	Signal Ground	Ground	Signal Ground
8	DCD	Output	Always On
9	+12V	Output	Always present
10	-12V	Output	Always present
11-19	—	—	Not used
20	DTR	Input	If Off, causes A/C-4 (B) to disconnect
21-25	—	—	Not used

A/C-4 (B)

3.1.4 THE PASSTHROUGH PORT

The passthrough port is permanently configured for DTE. The pins supported are pins 1 through 7 and pin 20. Pins 8 and 10 are not connected. The pin designations for the passthrough port are listed in Table 3-3.

When the main port is set for DCE, signals between the main port and the passthrough port are transferred directly (pin-to-pin). When the main port is set for DTE (for passthrough), the A/C-4 (B) performs some of the functions of a crossover cable. During passthrough, the A/C-4 (B) handles the signals as illustrated in Figure 3-2, with signal crossover shown on the right-hand side.

Table 3-3. Main and Passthrough Port Pin Designations during Passthrough.

DTE Mode		DCE Mode		In/Out	Connection to Passthrough Port
Pin No.	Pin Name	Pin No.	Pin Name		
1	Frame Ground	1	Frame Ground	Ground	Connected to pin 1
2	TXD	3	RXD	Output	Connected to pin 3
3	RXD	2	TXD	Input	Connected to pin 2
4	RTS	5	CTS	Output	Connected to pin 5 or held high, as preset by user
5	CTS	4	RTS	Input	Connected to pin 4
6	DSR	20	DTR	Input	Connected to pin 20
7	Signal Ground	7	Signal Ground	Ground	Connected to pin 7
8	DCD	8	DCD	Output	Always On; not connected to port
9	+12V	9	+12V	Output	Always present; not connected
10	-12V	10	-12V	Output	Always present; not connected
11-19	—	11-19	—	—	Not used
20	DTR	6	DSR	Output	Connected to Pin 6 or held high, as preset by user
21-25	—	21-25	—	—	Not used

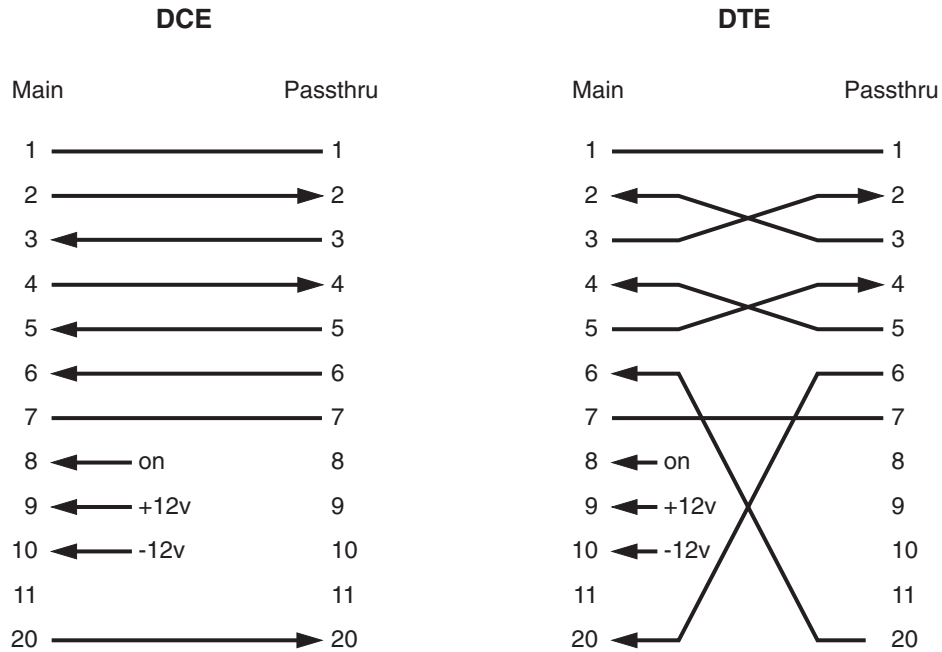

Figure 3-2. Passthrough Mode Signal Handling.

3.2 Cable Requirements

The two types of cables required for connecting equipment to the A/C-4 (B) are described below.

3.2.1 COAX CABLE

Attaching an IBM Controller to the A/C-4 (B) requires one RG62 A/U, 93 ohm, Type A coax cable with a male connector on each end. The maximum cable length is 5000 feet (1500 m).

3.2.2 RS-232 CABLE

The main and passthrough ports on the A/C-4 (B) each require RS-232 cable with the interface specifications shown in Tables 3-1 through 3-3. If the passthrough port is not used, attach a cable only to the main port. The recommended maximum length of cable is 50 feet (15 m).

3.3 Power Requirements

The power requirement for the A/C-4 (B) is 115 VAC, 3.2 Amp, 60 Hz or 230 VAC, 6 Amp, 50 Hz. Use only a properly grounded, three-prong outlet as a power source.

4. Installation

This chapter contains instructions for installing an A/C-4 (B) controlled by an IBM 3174, 3274, or 3276 Control Unit. See Appendixes D-G for the installation requirements for each of the terminals supported by the A/C-4 (B).

4.1 Equipment Requirements

The following equipment is required for installation:

- An A/C-4 (B) Protocol Converter
- An ASCII terminal (see **Sections 1.3.1** and **1.3.2**)
- RS-232 cable, 50-foot (15.2 m) recommended maximum length, with appropriate end connectors. (The A/C-4 (B) requires a male connector.)
- Type A coax cable, RG62 A/U, 93 ohm, 5000-foot (1524 m) maximum length with two male connectors.
- An IBM 3174, 3274, or 3276 Control Unit.

For detailed information on the interface specifications and cable requirements, see **Chapter 3**.

4.2 Unpacking

In order to protect the equipment and assure proper operation, unpack it as follows:

1. Inspect the shipping container for any obvious signs of damage. If the container or any of the enclosed parts appears to be damaged, contact the carrier immediately.
2. Open the box from the top. The name on the sides of the box is right-side up when the box is upright.
3. Remove the manual from the box.
4. Lift the molded foam packing out of the box.
5. Remove the power cord from the box.
6. The A/C-4 (B) is wrapped in plastic. Carefully lift the A/C-4 (B) out of the box and remove the plastic wrapping.

4.3 Installation Instructions

Perform the installation instructions in the order given. Although the terminal can be connected directly to the A/C-4 (B) or connected remotely through modems, first time users are advised to use a directly connected terminal when first configuring the A/C-4 (B). This simplifies installing the unit and initially detecting problems. The location of the LEDs, switches, and connectors are shown in Chapter 2.

CAUTION

Before beginning the installation procedure, verify that the power switch on the terminal and the power switch on the A/C-4 (B) are off.

1. Set the A/C-4 (B) on a flat, level surface.
2. Plug the female connector of the power cord into the A/C-4 (B) AC INPUT.
3. Plug the male connector of the power cord into a 110V, grounded AC outlet. Do *not* use adapters.
4. Set the DTE/DCE switch on the A/C-4 (B) back panel to DCE (out position) for connecting the terminal directly.
5. Put the terminal in an appropriate place. The terminal cannot be farther from the A/C-4 (B) than the length of the RS-232 cable that connects the terminal to the A/C-4 (B).
6. Plug the terminal's power cord into an appropriate outlet.
7. Connect an RS-232 cable male connector to the A/C-4 (B) main port. Make sure the connection is tight. Tighten the two attached screws.
8. Connect the other end of the RS-232 cable to the terminal's main port. Ensure that the connection is tight. Tighten the two attached screws.
9. Connect one end of the coax cable to an available Type A port on the IBM 3174, 3274, or 3276 Control Unit.

10. Connect the opposite end of the coax cable to the coax port (J5) on the rear panel of the A/C-4 (B).

11. See **Section 4.4** to continue the installation.

4.3.1 REMOTE APPLICATIONS USING MODEMS

Install a modem as follows:

1. Set the power switch on the A/C-4 (B) to the off position.
2. Turn the terminal power off.
3. Disconnect from the terminal the RS-232 cable attached to the main port.
4. Connect the RS-232 cable to a modem.
5. Set the A/C-4 (B) main port DCE/DTE switch to DTE (pressed in).
6. For dialed applications, set the modem to the auto-answer mode. Refer to the modem user's manual for additional information.
7. Connect another RS-232 cable to the main port of the terminal.
8. Connect the other end of the RS-232 cable to another modem.

When using an intelligent modem with the A/C-4 (B), some special considerations apply. When connecting the terminal to the A/C-4 (B), some modems send messages, codes, or other unexpected data, which interfere with the ability of the A/C-4 (B) to detect baud rate. Configure such modems for data transmission only and disable features which produce these codes or messages while connecting. This is particularly relevant to modems that use such messages as: RING, BUSY, and CONNECT.

4.3.2 THE PASSTHROUGH PORT

The asynchronous terminal connected to the main port of the A/C-4 (B) can also be connected to an ASCII host computer through an optional passthrough port. The passthrough port is permanently DTE. Since this port is designed to connect to the terminal through modems, a crossover cable must be used for connecting directly. For further information, refer to the user manuals provided with the modem and the host computer.

4.4 Initial Configuration

After the physical installation of the A/C-4 (B), configure the terminal and A/C-4 (B) as follows:

1. Turn on the terminal.
2. Set up the terminal according to the instructions given in **Appendix G**. Also refer to the user's manual for the terminal. The following settings are recommended for all terminals. Verify that the settings are available for your terminal:

Baud rate: 9600

Parity: Even

Data Bits: 7

3. Set the power switch on the A/C-4 (B) to position 1 (on). The PWR indicator on the front panel of the A/C-4 (B) should come on. If not, check the power cords and outlets to make sure they are connected properly.
4. Wait about five seconds while the A/C-4 (B) performs self tests. The CU SIG light on the front panel should come on, indicating the the A/C-4 (B) is answering polls from the control unit.
5. Press the carriage-return key, [CR]. The A/C-4 (B) baud rate is set for autobaud at the factory. On pressing [CR], the A/C-4 (B) detects the terminal's baud rate and sets that same rate for itself. The terminal should display the prompt:

Enter terminal type (ADM3A):

The terminal-type default is shown in parentheses; in this example, (ADM3A). If necessary, press [CR] again to obtain the prompt.

6. When using the default terminal type, press [CR]. The logon menu is displayed.

7. When using a terminal type other than the default, type the desired terminal emulator ID, and [CR]. The logon menu is displayed.

To display a list of all available terminal emulator IDs, type: ?. The terminals supported for the Standard model are listed in Table 1-1. The terminals supported for the Deluxe model are listed in Table 1-2.

8. Type the option number for the configurator: **2**. The terminal displays:

Enter Configuration Password.

9. Since the factory sets no password for entry to the configurator, press: [CR]. The terminal displays:

Change Configuration Password (Y/N):

10. If no password is desired, type: **N** or, press [CR]. The configuration menu (**Chapter 5**) is displayed with the configuration values set at the factory. Go to Step 12.

To set a configuration password, type: **Y**. The terminal displays:

Enter New Configuration Password:

11. When specifying a password, use eight alphanumeric characters, maximum. If using less than eight characters, press: [CR]. If using eight characters, do not press [CR].

After pressing [CR] or entering the eighth character, the configuration menu is displayed, showing the configuration values set at the factory.

12. Follow the procedure in **Section 5.4** to configure the A/C-4 (B). The terminals supported for the Standard model are listed in Table 1-1. After entering the required data and exiting from the configurator, the logon menu is displayed.

13. The terminals supported for the Standard model are listed in Table 1-1. The unit is now communicating with the Control Unit and is ready for operation. In order to complete the link between the control unit and the terminal, see **Section 5.2** to connect to the terminal.

5. Operating Procedures

This section gives the information required for operating both standard and deluxe models of the A/C-4 (B). The four operating modes are listed in **Section 5.1**. How to connect the A/C-4 (B) with an ASCII terminal is described in **Section 5.2**. Logon menu options are given in **Section 5.3**. Configuration parameters and settings are described in **Section 5.4**.

5.1 Summary of Operating Modes

The four modes of A/C-4 (B) operation are: Logon, Passthrough, 3278 Emulation, and Configuration.

5.1.1 LOGON

The logon menu (Figure 5-1) offers the following modes of operation as options: Passthrough, 3278 Emulation, Configuration, and Disconnect. As set at the factory, the Logon mode is the first mode of operation available when the terminal and A/C-4 (B) connect; however, you can specify 3278 emulation as the initial connect mode.

5.1.2 CONFIGURATION

The configurator allows the A/C-4 (B) to be tailored to a specific application. The configurator is selected from the logon menu. After configuring, the logon menu is redisplayed.

5.1.3 3278 EMULATION

3278 Emulation allows an async (ASCII) terminal to emulate an IBM 3278 Model 2 terminal for an IBM host. The factory sets logon as the initial connect mode, with the logon menu offering 3278 emulation as an option. However, 3278 emulation can be specified in the configurator as the first operation when connecting the terminal and A/C-4 (B). If 3278 emulation is the connect mode, emulation begins after powerup, unless a connect password is set. In this case, emulation begins after entering the password. When terminating 3278 emulation, the logon menu is redisplayed after specifying a terminal emulator.

5.1.4 PASSTHROUGH

The passthrough option is selected from the logon menu. The option provides an additional RS-232C port for an async terminal to connect to an async host (or other async device) while still connected to an IBM host through the main port. Passthrough allows communication between the async terminal and async host. However, the terminal can't access the IBM host during passthrough operations. After exiting from passthrough, select 3278 emulation from the logon menu if you wish to reconnect to the IBM host.

Detailed information about passthrough is given in **Sections 3.1** and **5.4**.

5.2 Establishing a Terminal-Host Session

When connecting to the terminal, the A/C-4 (B) may enter the Logon mode or begin 3278 emulation. The following procedure gives instructions for establishing a session between a terminal and an IBM host.

1. Turn power to the equipment on.
2. If autobaud has been selected, set the baud rate by pressing **<Enter>**. It may be necessary to press **<Enter>** two or more times. This procedure is required each time the A/C-4 (B) is powered up. After the baud rate is properly detected, the A/C-4 (B) requests a connect password, if one has been specified.
3. If no connect password is required, access is confirmed. Go to Step 7.

If a password is required, the following prompt is displayed:

Enter connect password:

4. Type the password, then press **<Enter>**.
5. If the password is correct, access is confirmed. Go to Step 7.

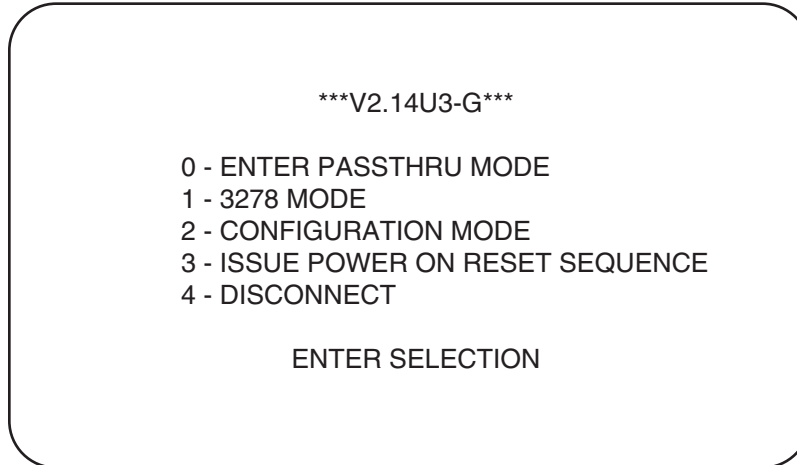

Figure 5-1. Logon Menu.

If the password is incorrect, the prompt is:

Invalid password
Enter connect password:

6. Three attempts at entering the correct password are allowed before the connection is dropped and the following message is displayed:

*** **Connection aborted** ***
 *** **Terminal Disconnected** ***

If the terminal is directly connected at a fixed baud rate, three more attempts are allowed for entering the correct password before the connection is dropped. If connected to a modem, the modem connector is terminated.

7. If 3278 emulation has been set as the initial connect mode, the terminal automatically begins 3278 emulation using the default terminal type specified in the configurator.

If the initial connect mode is set to logon, the A/C-4 (B) displays an identifying prompt. For example:

*** **V2.14U3-G** ***
Enter terminal type (ADM3A):

Where:

2.14 = Firmware Version 2.14
 U3-G = Model 3-G of the deluxe models
 Terminal type = the last used terminal driver; ADM3A, in this example. Or (if one was not last used this session) the default terminal type shown in the configuration menu.

This prompt identifies the ASCII terminal emulator used by the A/C-4 (B) at initialization.

8. To use the type of terminal emulator that is displayed, press **<Enter>**.
9. If another terminal emulator is required, type the appropriate terminal emulator ID and press **<Enter>**.
10. To display a list of valid emulator IDs, type **<?>** and press **<Enter>**.
11. If there is an error in entering the terminal emulator ID, the same prompt is redisplayed:
- Enter terminal type (ADM3A):**
12. The message is repeated until a valid emulator ID is selected.

5.3 Logon Mode

The Logon mode and menu options are discussed in the following paragraphs.

5.3.1 THE LOGON MENU

If the Logon mode is the first mode of operation when the A/C-4 (B) and the terminal are connected (initial connect mode), the logon menu is displayed after a valid terminal type is entered. The menu is shown in Figure 5-1. The Logon mode is offered when exiting any other mode after entering the terminal emulator. Five options (0 to 4) appear on the menu. The firmware version is the first line of the menu.

5.3.2 LOGON OPTION: PASSTHROUGH MODE

A/C-4 (B) provides two ports: the main RS-232C port for connecting to an async terminal (or other async device) and the coax port for connecting to an IBM controller. The passthrough option provides an additional RS-232C port: a passthrough port for connecting to an async host. The passthrough port allows the terminal to communicate directly with another async device, such as a VAX™ host computer. However, the terminal cannot communicate simultaneously with the IBM host and the async device.

To use the passthrough option:

1. Type the option number: 0.
2. Verify that the PASSTHRU indicator on the front panel illuminates.

To exit from passthrough operation:

1. Press: <Esc> (escape).
2. Type: < (The SHIFT key may be required on some terminals).
3. Press: <Enter> (carriage return).
4. The terminal returns to the Logon mode.

Use passthrough only when there is a suitable device attached to the passthrough port. Otherwise, the A/C-4 (B) may not receive the necessary signals from the device and may not respond to the exit sequence. If you select the passthrough option and there is no device attached to the passthrough port, the screen freezes. The high passthrough signals option may be used to prevent the screen from freezing.

If you cannot exit from passthrough:

1. Turn the A/C-4 (B) power off.
2. Turn the A/C-4 (B) power on.
3. Repeat the connect process (see Section 5.2).

5.3.3 LOGON OPTION: 3278 MODE

When using 3278 emulation, the terminal attached to the A/C-4 (B)'s main port appears to the host to be an IBM 3278 Model 2 terminal. The cursor control, screen display and keyboard functions performed by the terminal emulator are described in **Appendix G**.

If 3278 emulation has been selected as the first mode of operation when A/C-4 (B) and the terminal connect, begin emulation as follows:

1. If the baud rate is set to autobaud, press <Enter>. It may be necessary to press <Enter> two or more times. If the baud rate is fixed, it is not necessary to press <Enter>. If no connect password is set, go to Step 4. If a password is set, continue to Step 2.
2. If a connect password has been set, the prompt is displayed:

Enter connect password:
3. Type the password and press <Enter>.
4. The terminal begins 3278 emulation.

In summary: if a connect password is set, emulation begins after you enter the password and, if necessary, press <Enter>. If no password is set and the baud rate is fixed, the terminal begins 3278 emulation as soon as it is powered up. No prompt or menu is displayed. If no password is set and the baud rate is set to autobaud, emulation begins after <Enter> is pressed two or more times. To operate in any other mode, 3278 mode must be exited. See the exit key sequence below, under Exiting 3278 Mode.

To select 3278 emulation from the logon menu:

1. Type the option number: 1.
2. The screen clears.
3. The buffer data from the previous 3278 emulation session is displayed.
4. To operate in any other mode, exit from 3278 emulation. See the exit key sequence below.

In exiting from 3278 emulation, it is irrelevant whether the initial connect mode is 3278 emulation or Logon. To exit from 3278 emulation:

1. Enter the key sequence to initialize the terminal (see **Appendix G**).
2. The initial prompt is displayed.
3. Press **<Enter>** or type: (a new terminal type) and press **<Enter>**. The logon menu is displayed.

The IBM 3278 has a status line that shows how the terminal is functioning during 3278 emulation. The A/C-4 (B) provides a “display status line” command, a key sequence that alternately enables or disables a simulated IBM 3278 status line on the terminal. Only the standard ASCII characters displayable on the terminal are used in the simulation. The IBM 3278 terminal has 25 display lines with the 25th line as the status line. Most ASCII terminals, however, have only 24 display lines. In this case, the bottom display line (line 24) is replaced by the status information. Consequently, the status line must be disabled before data on line 24 can be seen. When the status line is in effect, the flashing asterisk, used to indicate keyboard lock, is inhibited. See **Section 5.4**.

Messages for the status line are listed and defined in **Appendix C**.

To display the status line during 3278 emulation:

1. Type the “display status line sequence.” The sequences for each type of terminal emulator are listed in **Appendix G**.
2. The status line is displayed on line 24. It replaces the last line of text.
3. To view the last line of text on 24-line terminals, or to stop displaying the status line type the display status line sequence again.

5.3.4 LOGON OPTION: CONFIGURATION MODE

The “Configuration Mode” option in the logon menu permits redefining the configuration parameters. These parameters are stored in nonvolatile memory (EEPROM) and preserved when the unit is powered off. The configuration menu is displayed, showing the default parameters last used. The configuration menus for each model are shown with factory-set defaults as follows: standard, Figure 5-2; deluxe, Figure 5-3. Configuration parameters and the initial configuration procedure are given in **Section 5.4**.

Enter the configurator from the logon menu, as follows

1. Type the option number: 2. The terminal displays:

Enter Configuration Password:

2. The factory default setting is NONE, no password required. Since no password is set, press **<Enter>**. Subsequently, if a password has been set, enter it. Since passwords are limited to eight characters, the next prompt appears after the eighth character is typed.

3. If the password is correct, or no password has been set, the terminal prompts:

Change Configuration Password (Y/N):

or, if the password is incorrect, the prompt is repeated:

Enter Configuration Password:

Three attempts are given to enter the password correctly before the logon menu is redisplayed.

4. If you do not wish to change or set a password, type: **N** or press **<Enter>**. The configuration menu is displayed.

To change or set a password, type: **Y**. The prompt appears:

Enter New Password:

5. Type the password, which may be up to eight letters or numbers. If the password is less than eight characters, press **<Enter>**. The configuration menu is displayed after **<Enter>** is pressed or after the eighth character is typed.

CONFIGURATION MENU V2.14U2-G

A.	DEFAULT TERMINAL TYPE	ADM3A
B.	BAUD RATE.....	AUTOBD
C.	PARITY	EVEN
D.	DATA BITS.....	7
E.	FLOW CONTROL	X-ON/X-OFF
F.	DISPLAY CASE	UPPER/LOWER
G.	NUMERIC LOCK.....	NO
H.	KEYBOARD LOCK/UNLOCK	(NONE)
I.	CONNECT PASSWORD	(NONE)
J.	INACTIVITY DISCONNECT (MINS.)	(NONE)
K.	CONNECT MODE.....	LOGON
L.	FORCED LOGOFF	(NONE)
	DATA.....	(NONE)
M.	PASSTHRU SIGNALS	(NONE)
N.	FLASHING ASTERISK	NO
O.	TYPEAHEAD	YES
P.	BANNER MESSAGE:	
Q.	EXIT AND SAVE	

ENTER SELECTION

Figure 5-2. Standard Model Configuration Menu.

CONFIGURATION MENU V2.14U3-G

A.	DEFAULT TERMINAL TYPE	ADM3A
B.	BAUD RATE.....	AUTOBD
C.	PARITY	EVEN
D.	DATA BITS.....	7
E.	FLOW CONTROL	X-ON/X-OFF
F.	DISPLAY CASE	UPPER/LOWER
G.	NUMERIC LOCK.....	NO
H.	KEYBOARD LOCK/UNLOCK	(NONE)
I.	CONNECT PASSWORD	(NONE)
J.	INACTIVITY DISCONNECT (MINS.)	(NONE)
K.	CONNECT MODE.....	LOGON
L.	FORCED LOGOFF	(NONE)
	DATA.....	(NONE)
M.	PASSTHRU SIGNALS	(NONE)
N.	FLASHING ASTERISK	NO
O.	TYPEAHEAD	YES
P.	COMPU Echo Suppression.....	NO
Q.	BANNER MESSAGE:	
R.	EXIT AND SAVE	

ENTER SELECTION

Figure 5-3. Deluxe Model Configuration Menu.

To exit from the configurator:

- 1.The only way to save changes is to select “Exit and Save.” The options changed are saved and effective immediately.
- 2.The logon menu is displayed.

5.3.5 LOGON OPTION: ISSUE POWER ON RESET

The option, issue power on reset, is listed on the logon menu. It allows the A/C-4 (B) to issue the power on reset (POR) signal to the IBM control unit. The control unit functions as if the IBM 3278 has been turned off and then turned on again. The signals between the A/C-4 (B) and the attached device are not dropped, leaving that connection active. A dialed line remains active. Use POR when the coax cable is replaced or when other attempts at correcting display problems have failed, such as refreshing the screen.

- 1.Type the option number: **3**.
- 2.The screen displays:

Power On Reset In Progress

- 3.The screen begins 3278 emulation, clearing the buffer of all data. This occurs regardless of which mode is set as initial connect mode.

5.3.6 LOGON OPTION: DISCONNECT

The disconnect option on the logon menu allows A/C-4 (B) to disconnect from the terminal. The A/C-4 (B) drops the DTR signal for one second in DTE mode or the DSR signal in DCE mode, then returns to its initial connect mode. Modem and terminal connections are dropped with the DTR or DSR signal. If a terminal is directly connected, the terminal immediately reconnects to the A/C-4 (B) and restarts the connect sequence.

To select this option:

- 1.Type the option number: **4**.
- 2.The terminal displays: ***** Terminal Disconnected *****
If autobaud is selected, to re-establish the baud rate, press **<Enter>**.

5.4 Configuration

The operating characteristics of A/C-4 (B) are selected in the configurator, using the configuration menu. The configuration menus for A/C-4 (B) models are shown as follows: standard, Figure 5-2; and deluxe, Figure 5-3. The figures show the parameter default values set at the factory. The configuration menu is displayed after the configuration password is entered correctly. The configuration parameters are displayed with the values set when the terminal was last used. The configuration parameters and available settings are discussed in the following paragraphs. The instructions assume that the procedure begins with the cursor at the prompt:

Enter Selection:

NOTE

New configuration settings take effect when exiting the configurator using the option “Exit and Save.” Autobaud takes effect after the terminal and the A/C-4 (B) are disconnected. Numeric lock takes effect when the A/C-4 (B) is reset (or turned off and on).

5.4.1 DEFAULT TERMINAL TYPE

Use this option to select the terminal emulator to be used each time the terminal and the A/C-4 (B) are powered up and each time the Logon mode is entered. To select the terminal emulator to be used:

- 1.Type: **A**
- 2.A list of all valid terminal emulators available is displayed with the prompt: **Enter Default Terminal Type:**
- 3.Enter the new default terminal emulator ID. To be accepted, new entries must match a valid terminal-emulator ID. Invalid entries are ignored. See **Chapter 1** for a list of the terminal emulators and terminals currently supported.
- 4.If you don’t want to change the default terminal, press **<Enter>**.
- 5.The configuration menu is displayed.

5.4.2 BAUD RATE

This option provides a choice of baud rates from 110 bps to 19.2 Kbps and autobaud. With autobaud the baud rates range from 300 to 19.2K and the A/C-4 (B) automatically detects and matches the baud rate of an attached device. Select the baud rate to suit the modem or terminal connected to the A/C-4 (B) To change the baud rate:

- 1.Type: **B**.
- 2.The screen clears and displays a list of all valid baud rates available. Before offering 19.2K baud, the A/C-4 (B) verifies whether 19.2K is a valid option. If 19.2K baud is available, the following is displayed:

Enter Baud Rate:

A) Autobaud	E) 2400
B) 19.2K	F) 1200
C) 9600	G) 300
D) 4800	H) 110

- 3.If 19.2K baud is not available, the following is displayed:

Enter Baud Rate:

A) Autobaud	E) 1200
B) 9600	F) 300
C) 4800	G) 110
D) 2400	

- 4.Type any option letter listed on your screen. Other values, including **<Enter>**, are ignored.
- 5.If selected, autobaud goes into effect after the terminal disconnects from the A/C-4 (B). Also, if autobaud is selected, the first screen does not appear until **<Enter>** is pressed two or more times, which determines the baud rate of the attached device.
- 6.110 baud is not available with autobaud. If 110 baud is required, select that option.
- 7.Any baud rate, except for autobaud, is effective immediately after exiting the configurator.
- 8.The configuration menu is redisplayed.

5.4.3 PARITY

This option provides the following choices for parity: odd, even, or none. To set parity:

- 1.Type: **C**.
- 2.The parity options are offered in the following display: **Enter Parity: (O)dd, (E)ven, (N)one**
- 3.Type one of the following: **O**, **E**, or **N**. All other choices are ignored, including **<Enter>**.
- 4.The configuration menu is redisplayed.

5.4.4 DATA BITS

This option sets the number of data bits in a character, with parity not counted as a data bit. To select the number of data bits:

- 1.Type: **D**.
- 2.The valid bits per character are displayed as follows: **Enter Data Bits Excluding Parity (7 or 8):**
- 3.Type: **7** or **8**. All other choices are ignored, including **<Enter>**.
- 4.The configuration menu is redisplayed.

5.4.5 FLOW CONTROL

This option provides for controlling the flow of data to and from the A/C-4 (B) when the data is transferred too quickly to be accepted. With no control, data may be lost. When data is received by A/C-4 (B), its input buffer can accept 36 characters after flow control is sent, before the input buffer overflows. After that, further input is lost.

Two types of flow control are available to regulate the rate at which data arrives: logical and physical. Logical flow control uses control codes, X-ON and X-OFF, sent by the device receiving the data. Physical flow control enables and disables one of the RS-232C interface signal lines. When the transmitting device receives the control code or signal change, the device should stop or resume data transmission. The requirements of the attached terminal or modem determine the type of flow control used. Refer to the terminal or modem user's manual for further information.

To set flow control for the A/C-4 (B)

- 1.Type: **E**.
2. The following is displayed:

Enter Flow Control Option:

 - A) **X-ON/X-OFF**
 - B) **CTS/RTS**
 - C) **Both**
 - D) **None**
- 3.Type one of the option letters: A, B, C or D. All other choices are ignored. The features of each option are:

A) X-ON/X-OFF — Select this option if the terminal uses logical flow control. If A/C-4 (B) sends data to the terminal too quickly, the terminal sends an X-OFF signal and A/C-4 (B) stops sending data. If the terminal inputs too fast to the A/C-4 (B), the A/C-4 (B) sends an X-OFF to the terminal. In both cases, X-ON is sent to start transmitting data again.

B) CTS/RTS — If the terminal supports physical flow control and the DTE/DCE switch is in the DCE position, the A/C-4 (B) drops the CTS (Clear To Send) signal when it is unable to accept more data. In the DTE position, the A/C-4 (B) drops the RTS (Ready To Send) signal. In both cases, the device sending the data (terminal or A/C-4 (B) should stop sending until the signal is raised.

C) Both — Both A and B above apply. This option is used for those terminals that may use either form of flow control. Logical flow control is implemented first, then physical flow control.

D) None — No flow-control action is taken by the A/C-4 (B). It is recommended that this option be used only if a device other than the terminal, such as an intelligent modem, is exercising flow control, or if flow control interferes with data transmission in any way.
- 4.After selecting a valid flow-control option, the configuration menu is redisplayed.

5.4.6 DISPLAY CASE

This option provides for displaying the alpha characters in upper case only or in upper and lower case.

- 1.Type: **F**.
- 2.The following is displayed:

Enter Display Case Option:

 - A) Convert Lower Case To Upper Case
 - B) Do Not Convert Lower Case
- 3.Type the option letter. All other choices are ignored, including **<Enter>**.
- 4.The configuration menu and prompt are displayed.

5.4.7 NUMERIC LOCK

This option allows the numeric lock to be enabled or disabled. When enabled, only the following characters may be entered into numeric fields:

- 1.Numeric characters (0 through 9)
- 2.Decimal sign (.)
- 3.Minus sign (-)

To enable the numeric lock:

- 1.Type: **G**.
- 2.The screen clears and displays:

Enable the NUMERIC LOCK feature (Y/N):
- 3.To enable the feature, type: **Y**. To disable the feature, type: **N**. All other choices are ignored, including **<Enter>**.

If **Y** is selected, the numeric lock is not activated until the A/C-4 (B) is powered off and then on, or until a POR (Power On Reset) is performed.

- 4.The configuration menu is displayed.

When the A/C-4 (B) is operating as a 3278 emulator, the numeric lock may be temporarily disabled by keying the numeric override sequence. The sequence is defined in **Appendix G** for each terminal. **Numeric override** is effective while the cursor remains in the field where numeric override was selected.

5.4.8 CONNECT PASSWORD

This option allows for limiting your access to the A/C-4 (B). If a connect password has been specified, A/C-4 (B) prompts you to enter a password before the terminal can be connected logically. If no password has been specified, A/C-4 (B) does not request one. To set a connect password:

- 1.Type: **I**.
- 2.The terminal displays:
Enter Connect Password:
- 3.If no password is desired, press **<Enter>**.
- 4.If a password is desired, type the password. The password may be up to 12 characters in length, and may contain any displayable ASCII characters.
- 5.If the password has less than 12 characters, press **<Enter>**. The configuration menu is redisplayed. If the password has 12 characters, the menu is displayed after the twelfth character is typed.

5.4.9 INACTIVITY DISCONNECT (MIN.)

Disconnecting occurs after dropping the data set ready (DSR) signal for one second. The inactivity disconnect option specifies the following:

- Whether the A/C-4 (B) should disconnect a terminal when there is no active input or output.
- How long the A/C-4 (B) waits before disconnecting.

To set the option:

- 1.Type: **J**.
- 2.The following is displayed:
Enter inactivity timeout (0 for none or 1-30 min.):
- 3.If you want the terminal not to disconnect (no inactivity timeout):
Enter: **<Enter>** (the configuration menu displays: **NONE**)
or : **0 (zero) <Enter>** (the configuration menu displays: 0)

To set an inactivity disconnect:

Enter: the time limit, in minutes (1 to 30)

Press: **<Enter>** (the configuration menu displays the time specified)

- 4.The inactivity disconnect is effective immediately after exiting the configurator. If an interval of one minute was selected and the terminal is not used for one minute, the terminal is disconnected from the A/C-4 (B) and the following message is displayed:

```
*** Inactivity Timeout ***
*** Terminal Disconnected ***
```

5.4.10 CONNECT MODE

This option specifies the mode of operation when A/C-4 (B) logically connects to a terminal. One of two modes of operation may be specified: Logon or 3278 emulation, as follows.

- 1.Type: **K**.
- 2.The following is displayed:

Enter Connect Mode:

(A) Logon mode
(B) 3278 mode

- 3.Type the letter of the initial connect mode: **A** or **B**. All other choices are ignored, including **<Enter>**.
- 4.The configuration menu is displayed.

5.4.11 FORCED LOGOFF

This option allows a code to be sent by the A/C-4 (B) to the IBM control unit when the A/C-4 (B) and the terminal are improperly disconnected. The code, specified by you, forces a logoff from the host whenever the terminal disconnects from the A/C-4 (B) in any of the following ways:

- 1.Powering off the terminal.
- 2.Disconnecting the modem line.
- 3.Pulling out a cord or RS-232C cable.
- 4.Allowing the inactivity time limit to elapse.

To select a code:

1.Type: **L**.

2.The screen displays:

Enter Forced Logoff Option:

PF1-24	CLEAR	POR
PA1-2	ENTER	SYSREQ NONE

3.Refer to **Appendix G** or the IBM control unit manual for a description of each function listed in Step 2. Select one of the key functions to command logoff:

PF1-24 — To select one PF (program function) key, type: **PFn** (where **n** = one number between 1 and 24). Press: **<Enter>**.

PA1-2 — To select one PA (program attention) key, type: **PA1** or **PA2** and press: **<Enter>**.

CLEAR — Type: **CLEAR** and press: **<Enter>**.

ENTER — Type: **ENTER** and press: **<Enter>**.

SYSREQ — Type: **SYSREQ**. Do not press **<Enter>** (see Forced Logoff Data, below). Select this option for a bisynchronous host that requires **TESTREQ**.

POR — Type: **POR** and press: **<Enter>**.

NONE — To specify no action when the terminal is disconnected. Type: **NONE** and press: **<Enter>** or press: **<Enter>**.

Note that **<Enter>** is pressed after selecting all options *except* **SYSREQ**.

4.The configuration menu is displayed.

5.When selecting **SYSREQ**, after the last character is typed, the screen displays the following:

Enter forced logoff data:

6.If no forced logoff data is desired, press: **<Enter>**. The configuration menu appears.

To get forced logoff data, type up to 30 characters and press: **<Enter>**. Or, after 31 characters are typed, the menu is displayed without pressing **<Enter>**. The configuration menu is displayed with the character string on the menu.

The A/C-4 (B) does not terminate the 3278 emulation session if the RS-232C link is broken. Use forced logoff to end the session if the RS-232C link is broken.

Forced Logoff Data is applicable only when **SYSREQ** is selected as the forced logoff code. If selected, A/C-4 (B) sends **SYSREQ** to the host as the logoff code, followed by forced logoff data (31 characters, maximum), followed by the **ENTER** character. Use **<Enter>** if no string is desired.

5.4.12 PASSTHROUGH SIGNALS

Passthrough is the mode of operation used for asynchronous communication between the following devices.

- A terminal or other device attached to the A/C-4 (B) main port.
- A device attached to the passthrough port, usually an ASCII host. When no device is attached to the passthrough port, use this option to specify which RS-232C signals are held high to the main port during passthrough.

Some asynchronous terminals cannot transmit data until the ready signal is received from the host. The ready signal is sent by the ASCII host to the A/C-4 (B), which passes it to the terminal. If the A/C-4 (B) main port is set to DCE, the ready signal can be DSR (Data Set Ready), CTS (Clear To Send), or both. If the main port is set to DTE, the signal can be DTR (Data Terminal Ready), RTS (Ready To Send) or both.

If the ASCII host does not supply the ready signal, A/C-4 (B) can supply it, thus enabling the terminal to transmit data.

The A/C-4 (B) monitors the data from the terminal in order to detect the exit-passthrough sequence. To exit from passthrough operation, the ready signal to the terminal must be high, or the A/C-4 (B) cannot detect the exit passthrough sequence. If the ready signal or signals are held high at the main port during the passthrough operation, the A/C-4 (B) can send the exit passthrough sequence. If they are not held high (or if there is no device attached to the passthrough port) and passthrough is inadvertently entered, the screen display freezes and you will be unable to exit, unless the A/C-4 (B) is powered off.

To select the signals to hold high:

- 1.Type: **M**.
- 2.The terminal displays:
Enter Signal(s) Held High While In Passthrough Mode:
A) DSR(DTR)
B) CTS(RTS)
C) DSR(DTR) & CTS(RTS)
D) None
- 3.Type the letter for the desired option: A, B, C or **D**. All other choices are ignored, including **<Enter>**.
- 4.The configuration menu is displayed.

5.4.13 FLASHING ASTERISK

This option allows the Flashing Asterisk feature to be enabled or disabled. When enabled, a flashing asterisk is displayed in the upper left-hand (cursor home) position of the screen. The asterisk is displayed whenever the status line is not enabled. The asterisk appears when the keyboard is locked.

To set this option:

- 1.Type: **N**.
- 2.The terminal displays:
Enable the FLASHING ASTERISK feature (Y/N):
- 3.To enable the feature, type: **Y**. To disable it, type: **N**. All other choices are ignored, including **<Enter>**.
- 4.The configuration menu is redisplayed.

5.4.14 TYPEAHEAD

Use this option to enable or disable the Typeahead feature. If Typeahead is enabled, data from the terminal is held in an A/C-4 (B) buffer when the keyboard is locked by the control unit. When the control unit signals keyboard unlock, data transfer resumes and the buffered data is output to the control unit. Typeahead avoids data loss resulting from data transmission during keyboard lock (see **Section 5.4**). If the input buffer is full, flow control (if enabled) prevents further input.

To set the option:

- 1.Type: **O**.
- 2.The screen clears and displays:
Enable the TYPEAHEAD feature (Y/N):
- 3.To enable Typeahead, type: **Y**. To disable Typeahead, type: **N**. All other choices are ignored, including **<Enter>**.
- 4.The configuration menu is redisplayed.

5.4.15 COMPU ECHO SUPPRESSION (DELUXE MODELS ONLY)

COMPU provides the echo suppression option for async devices that require suppressing the echo of input data. When the option is enabled, input data is not echoed back to the async device. The option applies only to the COMPU terminal emulator.

- 1.Type: **P**.
- 2.The screen clears and displays:
Enable the TYPEAHEAD feature (Y/N):
- 3.To enable Typeahead, type: **Y**. To disable Typeahead, type: **N**. All other choices are ignored, including **<Enter>**.
- 4.The configuration menu is redisplayed.

5.4.16 BANNER MESSAGE

Use this option to change the banner message, the first line of the A/C-4 (B) logon menu. To change the banner message:

- 1.For the standard model, type: **P**. For the deluxe model, type: **Q**.
- 2.The terminal displays:
Enter New Banner Message:
- 3.Type the new message, which can be composed of upper- and lower-case letters. The message may contain 79 characters maximum, including the spaces between words and leading spaces for centering the message.

After entering the message, if there are less than 79 characters, press: **<Enter>**. The configuration menu is displayed.

If the proposed message contains 79 characters or more, the configuration menu is displayed after the 79th character.

4. If no message is desired, press: **<Enter>**
Whenever the logon menu is displayed, no message appears.

5.4.17 EXIT AND SAVE

Use this option to save changes and exit from the configurator. To exit and save configuration changes:

1. For the standard model, type: **Q**. For the deluxe models, type: **R**.
2. The logon menu is displayed.
3. The A/C-4 (B) puts most configuration changes into effect immediately when the logon menu is redisplayed. Numeric lock (**Section 5.4**) is not activated until the terminal is powered off and back on, or until POR (**Section 5.3**) is performed. If the baud-rate option (**Section 5.4**) is changed to autobaud, it is not effective until the terminal is powered off and back on, or until the A/C-4 (B) and the terminal disconnect (**Section 5.3**). 3278 Emulation does not become the initial connect mode until the terminal and the A/C-4 (B) disconnect or power is turned off and on.
4. To return to 3278 emulation, enter the option number in the logon menu: **1**.

6. Troubleshooting

This chapter offers solutions to operational problems that may arise while using the A/C-4 (B). If a problem arises, follow the procedures given here. If the problem continues, or if you have a problem not covered here, assistance is available from Black Box.

WARNING

In order to avoid electric shock, use special care when operating the A/C-4 (B) with the protective cover removed. Only qualified technical personnel should operate or perform maintenance on the unit if the power is on and the cover is removed.

6.1 Contacting Black Box

For help in understanding the A/C-4 (B)'s operating procedures or securing maintenance for the A/C-4 (B), call Black Box. Follow the procedures in this section before telephoning for assistance, so that you can supply the information required to answer your inquiry.

6.1.1 READ THE MANUAL

Read this manual thoroughly. The manual contains the answers to most questions about operating the A/C-4 (B).

6.1.2 HAVE THE PRODUCT INFORMATION READY

Gather the following information so that you can give Black Box the exact product information.

1. Model — The name of the product, including the type of unit—for example, the “A/C-4 (B), deluxe.”
2. A/C-4 (B) firmware version number: from the logon menu or the configuration menu. For example, V2.14U3-G.
3. Hardware revision level: from the product label on the bottom or rear of the A/C-4 (B).
4. System configuration: the system type, local, remote, through modems, or by network nodes.

6.1.3 DESCRIBE THE SYMPTOMS

Prepare a detailed description of the unit's performance, if it appears to be operating incorrectly. To say the unit is dead does not adequately describe a unit's malfunctioning. In addition, review the following:

1. Are all the cables and wires connected?
2. Is the power on?
3. Are any lights or indicators on?
4. Did the unit make any unusual noises?
5. Are the connected units working, such as the host computer, terminals, modems, or network nodes?
6. If you own more than one A/C-4 (B), exchange units to determine if the symptoms are peculiar to one unit.

6.1.4 COLLECT THE PRODUCT REPAIR INFORMATION

After determining that the unit requires factory repair, gather the following information from the sources listed. Supply that information with the unit when it is returned.

1. Model, serial number, and revision level from the label on the bottom or rear of the unit.
2. Firmware version number from the logon menu or configuration menu; for example, 2.12U3-G.
3. Shipping address: where to ship the unit after repair.
4. Factory maintenance agreement number (FMA) or software maintenance agreement number, (SMA) if applicable, from your system manager.
5. Purchase order number from your company to pay for shipping and, in some cases, repair.
6. Return Authorization number (RA) from Black Box, to return the unit for repair.

6.2 Powerup Diagnostic Test Failure

At powerup, the A/C-4 (B) performs several diagnostic routines, including integrity tests of the following components:

- RAM (Random Access Memory)
- EPROM (Erasable Programmable Read Only Memory)
- EEPROM (Electronically Erasable Programmable Read Only Memory)

6.2.1 RAM TEST FAILURE

The RAM test consists of writing and reading a pattern of bits into the A/C-4 (B)'s memory to check for a RAM failure. If the A/C-4 (B) power switch is in the on position (1), the PWR indicator does not come on, and you are unable to communicate with the A/C-4 (B), then the RAM may have failed.

Another indication of RAM failure is the erratic flashing of the small red indicator, or heartbeat LED (light-emitting diode), on the printed circuit board. If RAM fails, the A/C-4 (B) ceases operation until it is powered off, then on again. If the erratic flashing continues, RAM has failed and the unit must be repaired. Call Black Box.

6.2.2 EPROM TEST FAILURE

The EPROM test consists of comparing the current CRC (Cyclic Redundancy Check) value of the firmware EPROMs to the value that is incorporated into the EPROMs when they are produced. If the CRC value does not agree with the incorporated value, an EPROM failure has occurred. On failing, the CRC value is transmitted to the terminal screen at the selected baud rate, or at 19,200 baud if autobaud is selected. This four-digit hexadecimal number is displayed at the current cursor position. The A/C-4 (B) resumes operation after a key is pressed.

The disagreement in CRC values indicates that the firmware EPROMs may not be operating properly and should be replaced. The first time the four-digit number is displayed, power the A/C-4 (B) off and then on. If the number is displayed again, call Black Box.

6.2.3 EEPROM VALIDITY CHECK

At powerup, the unit tests nonvolatile memory, the EEPROM. The EEPROM stores all configuration parameters. If an inconsistency between the firmware and the EEPROM is detected (such as a change in the EEPROM format), the EEPROM restores the factory-set default parameters, including the baud rate, which is reset to autobaud. The procedure to follow after detecting an EEPROM error is listed below:

1. After about five seconds, if the initial logon prompts are not displayed, press **<Enter>** to set the baud rate. When an EEPROM error is detected, the screen displays the default banner message and default terminal emulator. For example:

EEPROM verify error, CONFIG must be entered! * V2.14U3G *****

Enter terminal type (ADM3A):

Where: ADM3A is the factory-set default terminal emulator.

2. If the terminal type is correct, press **<Enter>**. If not, type the correct terminal ID and press **<Enter>**. The configurator is available for use. The configurator menu displays the values set at the factory. All configuration parameters must be reset at this time. See **Section 5.4**.

6.3 Terminal ID Prompt Failure

After powerup the terminal should be able to communicate with the A/C-4 (B). If the A/C-4 (B) is set for Autobaud, press **<Enter>** so that the A/C-4 (B) can detect the baud rate of the terminal. At this point the banner message and terminal emulator ID should be displayed. For example:

***** V2.14U3G *****

Enter terminal type (ADM3A):<R>

If the terminal emulator ID does not appear, follow these steps:

1. Check the configuration settings on the terminal for agreement with the A/C-4 (B).
2. Check for RAM or EPROM failure (**Section 6.2**).

3. Make sure that the DTE/DCE switch on the rear panel is set for the appropriate mode: DTE for modems and DCE for terminals or other directly connected equipment. If the switch is set correctly, go to Step 5.
4. If the DTE/DCE switch is not set correctly, set it now. Then power the A/C-4 (B) off and then on to reset it. If the problem persists, continue at Step 5.
5. Check that the RS-232C cable between the A/C-4 (B) and the terminal is wired correctly and that the connector has the correct pin settings.
6. Replace the cable between the A/C-4 (B) and the terminal. If there is still no response, substitute another terminal. If the problem continues, call Black Box.

6.4 CU SIG Indicator Failure

If the terminal and the A/C-4 (B) are communicating satisfactorily, but communication with the control unit cannot be established, verify that the CU SIG indicator on the A/C-4 (B) front panel is illuminated. If it is not on, the A/C-4 (B) is not receiving a signal from the control unit. The following steps should help determine the source of the problem.

1. Verify that the ends of the coax cable are properly connected to the ports on the control unit and the A/C-4 (B).
2. If the coax cable appears to be installed correctly, try connecting an IBM 3278 terminal, if available, to the same control unit port. If the IBM terminal operates, a hardware problem with A/C-4 (B) is likely. Call Black Box. If the IBM terminal does not operate, go to Step 3.
3. If the IBM terminal does not operate, connect it to a control-unit port that is known to function properly. If the terminal still does not operate, the coax cable may be faulty. Replace it. If the terminal functions properly at another port, a problem with the control unit is likely. Contact your IBM service representative.

4. Some models of the IBM 3274 Control Unit have Type A and Type B coax adapters. The A/C-4 (B) operates only when attached to a Type A adapter port. The Type B adapter is used with earlier model CRTs, such as IBM 3277 Model 2 terminals. Control-unit port groupings are labeled. Therefore, verify that the A/C-4 (B) is connected to a Type A coax port.

6.5 Erratic or Random Data on the Screen

When data is displayed erratically, the parity setting or the data bit setting may be incorrect. When the screen displays a random collection of characters, the terminal emulator specified in the configurator does not coincide with the terminal in use. To verify the emulator specified:

1. Try to enter the Logon mode.
2. If the terminal emulator is incorrect, disconnect the terminal using the disconnect option on the logon menu (Option 4).
3. If you are unable to communicate with the A/C-4 (B) or unable to enter Logon mode, power A/C-4 (B) off and then on. After the baud rate is set, the prompt for device type should be displayed. For example:

```
*** V2.14U3G ***
```

Enter terminal type (ADM3A):

4. Check **Appendix G** to verify that the correct terminal emulator is specified for the terminal in use. Then reconfigure the terminal parameters, such as baud rate, parity, etc., according to the instructions in **Section 5.4**. Change the faulty parameter(s), exit the configurator, and continue operation.

6.6 Changing the EPROM

To change a firmware EPROM on the A/C-4 (B):

1. Turn the A/C-4 (B) off and disconnect the power cord before changing the EPROM.
2. Unscrew the four screws that hold the top cover in place and remove the cover.
3. Look for the assembly number on the printed circuit board. To the right are the letters REV beside a white rectangle. The rectangle contains the revision letter of the board. The white rectangle may not appear on some boards, but the revision letter may. If the revision letter does not appear on the printed circuit board, it should appear on the bottom.

For models with revision letter D, replace two EPROMs (if your model has two EPROMs). For those with revision letter E, replace one EPROM.

4. Revision D and earlier:

Find the two EPROMs located and marked as follows:

Location 13B, number IL3278-0-D
Location 14B, number IL3278-1-D

Remove the EPROMs by pulling them out gently, being careful not to damage the pins if the EPROMs are to be used again. It may be necessary to slide a flat-blade screwdriver all the way under the EPROM to lift it.

5. Revision E:

Find the EPROM in location 13B. It is marked IL3278-E. @

Remove the EPROM by gently pulling it out, being careful not to damage the pins if the EPROM is to be used again. It may be necessary to slide a flat-blade screwdriver all the way under the EPROM to lift it.

6. Check the new EPROM(s). Each pin must be straight and at right angles to the chip. Gently bend any crooked pin back into place.
7. Set the first EEPROM (IL3278-0-D or IL3278-E) in location 13B, with the notched end of the EPROM aligned with the notched end of the socket. All pins must be straight and positioned above a hole.
8. Press gently until the EPROM is seated. The thin section of each pin should be totally inserted in each hole.
9. For the second EEPROM, repeat Steps 6-8. Insert the EEPROM in location 14B.
10. Replace the top of the unit and screw in the four (4) screws.

7. Glossary

- **ASCII** — American Standard Code for Information Interchange. Character code most commonly used by non IBM equipment.
- **Autobaud** — Setting which allows the A/C-4 (B) to determine the baud rate of a connection from the sending equipment as long as it is inside the valid range (300-19.2K baud).
- **Baud Rate** — Rate in bits per second at which data is transmitted.
- **Buffer** — Section of memory used for temporary storage of data entering and leaving the A/C-4 (B).
- **[CR]** — The code generated by the Carriage Return key. Also referred to as Enter or Return. Typically used to end an input string.
- **CRT** — Cathode Ray Tube. A screen like that of a television receiver, used in computer systems for viewing data. A CRT with an attached keyboard forms a terminal.
- **CTS** — Clear to Send. A pin on an RS-232 interface for a modem, used to indicate whether the modem is ready to accept data for transmission.
- **CU SIG Indicator** — Control Unit Signal. Light on the front panel of the A/C-4 (B) that, when illuminated, indicates that the A/C-4 (B) is answering polls from the control unit.
- **DCE** — Data Communications Equipment. Equipment used for transmission of data between two terminal devices. Such equipment provides functions including signal conversion (for example, digital to analog), and connection establishment and termination. Standards define the signal specifications for the serial digital DCE interface.
- **Default Value** — Factory setting or value used if no alternative value is specified.
- **Device** — A combination of physical components forming a unit that performs a specific function. A piece of equipment, such as a terminal, a modem, a line driver, or a network node.
- **Disconnect** — To logically disconnect a terminal from the A/C-4 (B) (Power off, inactivity timeout, etc. will cause a disconnection).
- **Display** — A visual representation of data on the screen of a CRT. To present data on the screen of a CRT.
- **DOS** — Disk Operating System. An operating system for a computer stored on disk, rather than in main memory.
- **DSR** — Data Set Ready. A pin on an RS-232 interface for a modem that indicates whether the modem is connected to a communication channel and is ready to exchange control characters to begin data transmission.
- **DTE** — Data Terminal Equipment. Equipment used as the terminating device in a data communications environment. Standards define the signal specification for the serial digital DTE interface.
- **DTR** — Data Terminal Ready. A pin on an RS-232 interface for a modem that prepares and maintains the connection to a communicating channel.
- **EBCDIC** — Extended Binary Coded Decimal Interchange Code. Character code used by IBM equipment.
- **EPROM** — Erasable Programmable Read Only Memory. Nonvolatile memory used to store and retain the A/C-4 (B) firmware.
- **Firmware** — The program contained in a set of EPROMs installed in the A/C-4 (B).
- **Flow Control** — Feature that allows ASCII data streams to be paced to prevent data loss from buffer overflow. Used on the asynchronous side of the A/C-4 (B).
- **Host Computer** — A computer to which a number of terminals and/or other smaller computers are connected, providing computation, stored file access, programming languages, and other services.
- **IBM 3278** — The IBM Display terminal (Model 2 only) that the A/C-4 (B) emulates.

- **Inactivity Disconnect** — Feature that disconnects a terminal from the A/C-4 (B) after a specified period of inactivity.
- **Inbound Data** — Data headed toward the IBM (EBCDIC) host computer.
- **Initial Connect Mode** — Mode (either Logon or 3278) which a terminal enters upon connection to the A/C-4 (B).
- **Keyboard Lock/Unlock** — Logical locking mechanism used by IBM to prevent data from being input at certain times. When in effect, input data is ignored. When unlocked, data may be entered. This is handled by the control unit.
- **LAN** — Local Area Network. Pieces of equipment directly connected together in a network.
- **LED** — Light-Emitting Diode. A semi-conductor diode that emits light when a current is passed through it.
- **Mode** — A method or condition of operation.
- **Modem** — Modulator-Demodulator. A device that converts digital data into analog data and analog data into digital data that can be transmitted over communication lines between a computer and a terminal or other device.
- **Network** — A system consisting of a computer or computers and the connected terminals and related devices, such as modems, network nodes, and input/output channels.
- **Network Node** — A terminal or cluster of terminals with a cluster controller in a network.
- **Numeric Lock** — Feature that allows only specific characters to be entered in a numeric field. This may be overridden by using the Numeric Override function. Refer to the appropriate IBM System manual.
- **Outbound Data** — Data headed away from the IBM (EBCDIC) host computer.
- **Passthrough** — Mode which allows an ASCII terminal to be connected to ASCII host while still connected to an IBM host. Data is transferred between the ASCII devices through the A/C-4 (B) without modification. Connecting to the IBM or ASCII host is selected as a menu option.
- **POR** — Power On Reset. Emulation of the effect of powering the actual IBM 3278 terminal off, then on again. RS-232 signals are maintained.
- **RAM** — Random Access Memory. A type of integrated circuit that has memory which can be read but not changed and is usually used for program instructions.
- **ROM** — Read Only Memory. A type of integrated circuit that has memory which can be read but not changed and is usually used for program instructions.
- **RS-232** — A common name for a cable or interface that is based on the EIA standard that defines the functionality of interfaces between ASCII computer devices.
- **RTS** — Request to Send. A pin on an RS-232 interface for a modem that puts the modem into a transmit mode of operation rather than a receive mode.
- **Session** — The time between the terminal logging on to and disconnecting from the host computer.
- **Status Line** — A line displayed on the bottom of a screen to indicate current status of the connected terminal along with all associated devices. This is output by the IBM control unit.
- **Terminal** — A device by which a user sends data to and receives data from a computer system, especially a keyboard and attached CRT.
- **Terminal ID** — A unique character string of up to six characters which identifies the terminal type to the A/C-4 (B).
- **Typeahead** — The ability of the A/C-4 (B) to accept data while in the logical keyboard locked state.
- **X-ON/X-OFF** — Logical character codes used as flow-control triggers.

Appendix A: EBCDIC-to-ASCII Translation Tables

Appendix A contains the EBCDIC-to-ASCII data translation table used by the A/C-4 (B). The table shows how an EBCDIC character entering the synchronous side of the IBM control unit is translated into an ASCII character for output to the asynchronous port of the A/C-4 (B).

EBCDIC is translated to ASCII by character equivalence, when possible. However, certain EBCDIC characters have no ASCII equivalents. The characters are translated as follows:

EBCDIC	ASCII
¢ (4A)	[(5B)
¬ (5F)	^ (5E)
l (4F)	l (7C)

For EBCDIC data, several codes in the control code range (below hex 40) are part of the 3270 protocol (buffer orders, printer orders, SCS codes, etc.). They are not directly translated for ASCII output. For example, the EBCDIC code hex 11 is “set buffer address.” This character, plus the two following characters, change where data is written on the display screen. Other control values and characters (hex 40 through FF) that have no ASCII equivalents are translated to the ASCII minus-sign (hex 2D).

Table A-1 lists the translation of the EBCDIC characters for English characters used by IBM controllers in the United States. The translation of the EBCDIC characters listed below depends on the customization of the IBM controller, varying from country to country:

- 41-49
- 51-59
- 62-69
- 70-78
- 80
- 8A-90
- 9A-9F
- A0
- AA-BF
- CA-CD
- DA-DC
- EA-EC
- FA-FD

Table A-1. EBCDIC-to-ASCII Translation—U.S. English Characters.

EBCDIC	ASCII	EBCDIC	ASCII	EBCDIC	ASCII	EBCDIC	ASCII
40 SP	20 SP	70	7E ~	A0	49 I	D0]	7D {
41	5B [71	7C I	A1 ~	7E ~	D1 J	4A J
42	5D]	72	60 '	A2 s	73 s	D2 K	4B K
43	23 #	73	7E ~	A3 t	74 t	D3 L	4C L
44	5C \	74	5C \	A4 u	75 u	D4 M	4D M
45	24 \$	75	7B {	A5 v	76 v	D5 N	4E N
46	24 \$	76	65 e	A6 w	77 w	D6 O	4F O
47	7E ~	77	69 i	A7 x	78 x	D7 P	50 P
48	40 @	78	7C I	A8 y	79 y	D8 Q	51 Q
49	20 SP	79 '	60 '	A9 z	7A z	D9 R	52 R
4A ¢	5B [7A :	3A :	AA	4F O	DA	4F 0
4B .	2E .	7B #	23 #	AB	7C I	DB	55 U
4C <	3C <	7C @	40 @	AC	5B [DC	5C \
4D (28 (7D '	27 '	AD	5D]	DD	2D -
4E +	2B +	7E =	3D =	AE	59 Y	DE	2D -
4F I	7C I	7F "	22 "	AF	41 A	DF	2D -
50 &	26 &	80	7D }	B0	45 E	E0 \	5C \
51	20 SP	81 a	61 a	B1	45 E	E1	7B {
52	20 SP	82 b	62 b	B2	49 I	E2 S	53 S
53	5E ^	83 c	63 c	B3	4F O	E3 T	54 T
54	7E ~	84 d	64 d	B4	55 U	E4 U	55 U
55	31 1	85 e	65 e	B5	59 Y	E5 V	56 V
56	32 2	86 f	66 f	B6	5C \	E6 W	57 W
57	40 @	87 g	67 g	B7	5B [E7 X	58 X
58	7D }	88 h	68 h	B8	45 E	E8 Y	59 Y
59	69 i	89 i	69 i	B9	49 I	E9 Z	5A Z
5A !	21 !	8A	61 a	BA	5C \	EA	7C I
5B \$	24 \$	8B	5D]	BB	5D]	EB	7D }
5C *	2A *	8C	5E ^	BC	41 A	EC	7C I
5D)	29)	8D	6F o	BD	5D]	ED	2D -
5E ;	3B ;	8E	75 u	BE	5E ^	EE	2D -
5F ¬	5E ^	8F	61 a	BF	4F O	EF	2D -
60 -	2D -	90	60 '	C0 {	7B {	F0 0	30 0
61 /	2F /	91 j	6A j	C1 A	41 A	F1 1	31 1
62	6F o	92 k	6B k	C2 B	42 B	F2 2	32 2
63	7C I	93 l	6C l	C3 C	43 C	F3 3	33 3
34 4	64	7B {	94 m	6D m	C4 D	44 D	34 4
65	7D }	95 n	6E n	C5 E	45 E	F5 5	35 5
66	59 Y	96 o	6F o	C6 F	46 F	F6 6	36 6
67	7B {	97 p	70 p	C7 G	47 G	F7 7	37 7
68	7D }	98 q	71 q	C8 H	48 H	F8 8	38 8
69	5D]	99 r	72 r	C9 I	49 I	F9 9	39 9
6A I	7C I	9A	7C I	CA	55 U	FA	5B [
6B	2C ,,	9B	6F o	CB	41 A	FB	5C \
6C %	25 %	9C	75 u	CC	40 @	FC	5D]
6D _	5F _	9D	7C I	CD	49 I	FD	5C \
6E >	3E >	9E	41 A	CE	2D -	FE	2D -
6F ?	3F ?	9F	45 E	CF	2D -	FF	2D -

Appendix B: ASCII-to-EBCDIC Translation Table

Appendix B contains the ASCII-to-EBCDIC data translation table used by the A/C-4 (B). The table shows how an ASCII character entering the asynchronous port of the A/C-4 (B) is translated into an EBCDIC character for output to the synchronous side of the IBM control unit.

For keyboard input, the following are valid only as keyboard function codes: ASCII codes below hexadecimal 20 and 7F. The A/C-4 (B) tests those values to determine whether they are the first or only character of a string used to emulate a 3278 keyboard function, such as ENTER, PA, PF, etc. Function-code strings are terminal-dependent. They are defined in **Appendix G**.

ASCII is translated to EBCDIC by character equivalence, when possible. However, certain ASCII characters have no EBCDIC equivalents. Those characters are translated as follows:

ASCII	EBCDIC
[(5B)	¢ (4A)
^ (5E)	¬ (5F)
] (5D)	! (4F)

Table B-1 shows the translation of the EBCDIC character for English characters used by IBM controllers in the United States. The translation depends on the customization of the IBM controller, which can vary from country to country.

Table B-1. ASCII to EBCDIC Translation—U.S. English Characters.

ASCII	EBCDIC	ASCII	EBCDIC	ASCII	EBCDIC
20 SP	40 SP	40 @	7C @	60 '	79 '
21 !	5A !	41 A	C1 A	61 a	81 a
22 "	7F "	42 B	C2 B	62 b	82 b
23 #	7B #	43 C	C3 C	63 c	83 c
24 \$	5B \$	44 D	C4 D	64 d	84 d
25 %	6C %	45 E	C5 E	65 e	85 e
26 &	50 &	46 F	C6 F	66 f	86 f
27 '	7D '	47 G	C7 G	67 g	87 g
28 (4D (48 H	C8 H	68 h	88 h
29)	5D)	49 I	C9 I	69 i	89 i
2A *	5C *	4A J	D1 J	6A j	91 j
2B +	4E +	4B K	D2 K	6B k	92 k
2C ,	6B ,	4C L	D3 L	6C l	93 l
2D -	60 -	4D M	D4 M	6D m	94 m
2E .	45 .	4E N	D5 N	6E n	95 n
2F /	61 /	4F O	D6 O	6F o	96 o
30 0	F0 0	50 P	D7 P	70 p	97 p
31 1	F1 1	51 Q	D8 Q	71 q	98 q
32 2	F2 2	52 R	D9 R	72 r	99 r
33 3	F3 3	53 S	E2 S	73 s	A2 s
34 4	F4 4	54 T	E3 T	74 t	A3 t
35 5	F5 5	55 U	E4 U	75 u	A4 u
36 6	F6 6	56 V	E5 V	76 v	A5 v
37 7	F7 7	57 W	E6 W	77 w	A6 w
38 8	F8 8	58 X	E7 X	78 x	A7 x
39 9	F9 9	59 Y	E8 Y	79 y	A8 y
3A :	7A :	5A Z	E9 Z	7A z	A9 z
3B ;	5E ;	5B [4A ¢	7B {	C0 {
3C <	4C <	5C \	E0 \	7C	6A
3D =	7E =	5D]	4F	7D }	D0 }
3E >	6E >	5E ^	5F ¬	7E ~	A1 ~
3F ?	6F ?	5F _	6D _		

Appendix C: Status Line Messages

The key sequence “Display Status Line” displays a simulated IBM 3278 status line on the terminal during 3278 emulation. The flashing asterisk indicates that keyboard lock is inhibited when the status line is displayed. Display line 24 is replaced by a simulated IBM 3278 status line. Updates to line 24 are not displayed until the status-line display is terminated by entering the Display Status Line key sequence again.

C.1 Display Codes

The A/C-4 (B) uses standard ASCII characters to simulate the IBM messages displayed on an IBM 3278 display station. The abbreviations used in the status line are shown in the tables below. In general, a particular status message appears in only one position on the status line; therefore, the messages are grouped according to the column in which they appear.

Table C-1. Status Line Position 1-6—Readiness and System Connection.

A/C-4 (B) Message	Explanation
4, 6 or S	The control unit is ready.
A or B	The control unit is connected to the host using either A or B rules.
*	The terminal is working with your applications program.
f	The terminal is connected to the system operator or control program.
?	The terminal is connected to the host system but is not connected to your applications program or to the control program.

Table C-2. Status Line Position 9-27—Input Inhibited Messages.

A/C-4 (B) Message	Explanation
X	Keyboard input inhibited. Shown in conjunction with all following messages.
WT	Wait. Allow time for host application to perform a function.
? or ?+	Input not understood. Press RESET, if necessary.
< F >	Move cursor to another area on the screen to perform desired function.
F>	Too much data for field.
-S	The requested symbol is not available.
#	(Followed by a number.) Machine error. Indicates that the system is not functioning properly.
COMM	(Followed by a number.) Communications Error. Problem with communications line between the control unit and the host.
PROG	Program Error. Error in the program data received from the host.
F	Terminal operator.

Table C-3. Status Line Position 37-41—Shifts, Modes, and Other Indicators.

A/C-4 (B) Message	Explanation
^	Shift key is depressed or keyboard in Shift mode.
I	Terminal is in Insert mode.
NUM	Keyboard is in Numeric Shift mode.

Table C-4. Status Line Position 37-41—Shifts, Modes, and Other Indicators.

A/C-4 (B) Message	Explanation
OCO	(Followed by a number.) Indicates the status of the printer assigned for the terminal.

C.2 Number Codes

Some of the above messages may be followed by numbers which further isolate the problem. Some of the more common codes are listed below, along with suggestions for clearing the problem which caused the code to appear.

Machine Check Codes — 201 to 269

If any of the following message codes appear, power the unit off and then on. If the problem persists, call your supplier.

- 202 — Internal terminal error
- 204 — Terminal buffer parity error
- 207 — Terminal failed to respond to the control unit

Category A Adapter Failure — 290 to 299

Call the IBM Customer Engineer if an error code appears in this range.

Control Unit Hardware Failure — 301 to 399

Call the IBM Customer Engineer if an error code appears in this range.

Program Check Codes — 401 to 499

The following codes indicate a problem with the host application program. Contact the systems programmer.

- 408 — Line buffer overflow
- 413 — Function not supported
- 474 — No extended dcb was customized for this device

Communication Check Codes — 501 to 599

Communication check codes indicate a possible problem with a modem.

- 501 — Clear to send not present
- 502 — Data set ready line dropped
- 504 — Control is disconnected from the line
- 505 — Initial state of control unit after a disconnect command was received
- 520 — Timeout (valid frame was not received within 30 seconds)
- 530 — Write timeout: CTS has dropped

Further information about status line error codes may be obtained from the *IBM 3270 Information Display System — 3274 Control Unit Description and Programmers Guide* which is available from IBM (P/N GA23-0061-1).

Appendix D: Terminal and PC Support

CAUTION

The IBM 3274 Control Unit microcode release 65.1 or later, without the proper RPQs, supports only Program Function (PF) keys 1-12 on IBM 3278 coax terminals, whereas earlier releases supported PF1-24. Therefore, if you are using release 65.1 or later in an IBM 3274 to which an A/C-4 (B) is attached, the key sequences for PF13-24 will not function correctly.

A subsequent release of A/C-4 (B) firmware will provide an alternative IBM terminal emulation which will restore support for all 24 PF keys.

The A/C-4 (B) is a protocol converter used to connect an IBM 3174, 3274 or 3276 controller to an asynchronous ASCII terminal so that the terminal can emulate the IBM 3278 Model 2 Display Station. The A/C-4 (B) may also be used to connect an IBM Personal Computer or compatible.

This manual describes how to use the various ASCII terminals supported by the A/C-4 (B). Essentially, this handbook describes how to generate IBM 3278 functions through ASCII terminal keyboards that do not ordinarily generate those functions.

Each terminal type is described in terms of terminal setup for the A/C-4 (B) interface, keyboard emulation, and other special features. Information for each terminal is given in separate sections, listed alphabetically by the identification code of the terminal.

Section D.1 contains information about the terminals supported by the A/C-4 (B). The A/C-4 (B) terminal emulators and the ASCII terminals they support are listed in Table D-1. Terminals are listed by manufacturer and correlated with emulator IDs in Table D-2. The tables are updated as groups of terminals are added to the manual. If the terminal you wish to use with the A/C-4 (B) is not referenced, contact your supplier to determine if the terminal is supported.

D.1 ASCII Terminal Support

A/C-4 (B) terminal emulators and the models they support are listed in Table D-1.

The terminals supported by the A/C-4 (B) are listed by manufacturer in Table D-2. Terminals are correlated with the ID of the supporting terminal emulator.

Table D-1. Terminal Emulators Supplied with A/C-4 (B).

ID	Terminal Models Supported
ACT5A	Microterm ACT5-A
ADM11	Lear Sielger ADM-11
ADM12	Lear Sielger ADM-12
ADM178	Lear Sielger ADM-178
ADM21	Lear Sielger ADM-21/22/23/24
ADM24E	Lear Sielger ADM-24E
ADM2D	Lear Sielger ADM-21 Order Entry
ADM3A	Lear Sielger ADM-3A, Hazeltine Esprit, Qume AVT-102, TeleVideo Personal Terminal, Visual 50/200
ADM3P	Lear Sielger ADM-42/-5 (ADM-3A enhanced)
ANSI	ANSI Standard 3.64 terminals, Falco FAME-II
C108	Human Designed Systems Concept 108/APL-9
C530	Soroc Challenger 530
COMPU	Does not format data, passes data straight through
D450	Data General Dasher D400/D450
DG200	Data General Dasher D100/D200, Visual 110
DISPI	Northern Telecom Displayphone
DM20	Beehive DM-20/Standard/Plus
DM5	Beehive DM-1/5/10/30 Basic
DM5AB	Beehive DM-5A/5B
DM78	Beehive DM-78
HP125	Hewlett Packard HP-2624/2626, HP-2382/2622/2623
HP21	Hewlett Packard HP-2621B/2641
HP45	Hewlett Packard HP-2645, HP-2621A/P
HZ14	Hazeltine 1400/1420
HZ150	Hazeltine 1500
HZ151	Hazeltine 1510/1520
HZ78	Hazeltine Esprit 10-78, PCI 78
I3101	IBM 3101, Informer 301/401, Telex 310
I3161	IBM 3161/3163
IBMPC	IBM Personal Computer and compatibles
INF205	Informer 205/207
SCANS	Tymshare Scanset
T4420	Teletype 4420/4424, Cado
T5410	AT&T Teletype 5410
T5420	AT&T Teletype 5420
TV910	TeleVideo TV910, Hazeltine Esprit II, Radio Shack DT-1
TV910P	TeleVideo TV910+/912

Table D-1. Terminal Emulators Supplied with A/C-4 (B).

ID	Terminal Models Supported
TV925	TeleVideo TV920/925/950, Datamedia DT80/3, Hazeltine Esprit III, Lear Siegler ADM-31/32, Liberty Electronics Freedom 100, Zentec Zephyr
TV970	TeleVideo TV970
VIEWC	ADDS Viewpoint/Color
VIEWP	ADDS Viewpoint/Regent, NCR 7901
VIP731	Honeywell VIP-7301
VP60	ADDS Viewpoint/60
VP78	ADDS Viewpoint/78, NCR 7978
VP78C	ADDS Viewpoint/78 Color
VT100	Digital Equipment Corp. (DEC) VT100/VT101/VT125, Anderson Jacobsen AJ-520, Beehive ATL-008, C.Itoh 101, Colorgraphic MVI-100, Data media Colorscan 10, Datamedia DT80/1/2, Datamedia DT80/5, Direct VP800C, Falco Fame-100, Lear Siegler ADM-36, Microterm MIME-740/Ergo 4000, MVI 7, TAB 132/15, Visual 100/300/400, Zenith Z-19
VT102	Digital Equipment Corp VT102
VT52	Digital Equipment Corp. VT52, Anderson-Jacobsen AJ-520, Datamedia Colorscan 10, Datamedia DT80/1/2, Falco TS-1, Informer 301/401, KDE 820, Microterm MIME-2A, Microterm MIME-740/Ergo 4000, TAB 132, Visual 50/200, Zenith Z-19, Zenith ZT-1
VT52X	Digital Equipment Corp. VT52 without numeric keypad
WY100	WYSE WY-100

Table D-2. ASCII Terminals and Emulators.

Manufacturer	Terminal	Terminal Emulator ID	Listed User
ADDS	Viewpoint/Regent Viewpoint/60 Viewpoint/78 Viewpoint/78 Color Viewpoint/Color	VIEWP VP60 VP78 VP78C VIEWC	
Anderson Jacobsen	AJ-520	VT52 or VT100	DEC
ANSI Standard 3.64	(note 1)	ANSI	
AT&T	ATT 5410 ATT 5425	T5410 T5420	Teletype Teletype
Beehive	ATL-008 DM-1/5/20/30 Basic DM-20/Standard/Plus DM-5A/5B DM-78	VT100 DM5 DM20 DM5AB DM78	DEC
Cado		T4420	Teletype
C.Itoh	101	VT100	DEC
PC-PC applications	(Note 2)	COMPU	
Colorgraphic	MVI-100	VT100	DEC
Data General	Dasher D100/D200 Dasher D400/D450	DG200 D450	
Datamedia	Colorscan 10 DT80/1/2 DT80/3 DT80/5	VT52 or VT100 VT52 or VT100 TV925 VT100	DEC DEC TeleVideo DEC
Digital Equipment Corp. (DEC)	VT100/VT101/VT125 VT102 V T52 CT-52 (No keypad)	VT100 VT102 VT52 VT52X	
Direct	VP800C	VT100	DEC
Falco	FAME-100 FAME-II TS-1	VT100 ANSI VT52	DEC ANSI DEC

Table D-2 (continued). ASCII Terminals and Emulators.

Manufacturer	Terminal	Terminal Emulator ID	Listed User
Hazeltine	1400/1420 1500 1510/1520 Esprit Esprit 10-78 Esprit II Esprit III	HZ14 HZ150 HZ151 ADM3A HZ78 TV910 TV925	Lear Siegler TeleVideo TeleVideo
Hewlett-Packard	HP-2382/2622/2623 and /2624/2626 HP-2621A/P/2645 HP-2621B/2641	HP125 HP45 HP21	
Honeywell	VIP-7301	VIP731	
Human Designed Systems	Concept 108/APL8	C108	
IBM	3101 3161/3163 PC and compatibles	I3101 I3161 IBMPC	
Informer	205/207 301/401	INF205 VT52 or I3101	DEC IBM
KDE	820	VT52	DEC
Lear Siegler	ADM-11 AMD-1178 ADM-12 AMD-21/22/23/24 ADM-21 Order Entry ADM-24E ADM-31/32 ADM-36 ADM-3A ADM-42 ADM-5	ADM11 ADM178 ADM12 ADM21 ADM2D ADM24E TV925 VT100 ADM3A ADM3P (Note 3) ADM3P (Note 3)	TeleVideo DEC
Liberty Electronics	Freedom 100	TV925	TeleVideo
Microterm	ACT-5A MIME-2A MIME-740/Ergo 4000	ACT5A VT52 VT52 or VT100	DEC DEC
MVI	7	VT100	DEC
NCR	7901 7978	VIEWP VP78	ADDS ADDS

Table D-2 (continued). ASCII Terminals and Emulators.

Manufacturer	Terminal	Terminal Emulator ID	Listed User
Northern Telecom	Displayphone	DISPI	
PCI	78	HZ78	Hazeltine
Qume	QVT-102	ADM3A	Lear Siegler
Radio Shack	DT-1	TV910	TeleVideo
Soroc	Challenger 530	C530	
TAB	132 132/15	VT52 VT100	DEC DEC
Teletype	4420/424 5410 5420	T4420 T5410 T5420	
TeleVideo	TV910 TV910+/912 TV920/925/950 TV970 Personal terminal	TV910 TV910P TV925 TV970 ADM3A	Lear Siegler
Telex	310	I3101	IBM
Tymshare	Scanset	SCANS	
Visual	100/300/400 110 50/200	VT100 DG200 ADM3A or VT52	DEC Data General Lear Siegler or DEC
Wyse	WY-100	WY100	
Zenith	Z-19 ZT-1	VT52 or VT100 VT52	DEC DEC
Zentec	Zephyr	TV925	TeleVideo

Notes:

1. Any terminal which complies to ANSI Standard 3.64 can be supported by the ANSI terminal module.
2. The COMPU module simplifies the interface between the IBM host computer and micro-, mini-, and instrumentation computers.
3. The ADM3P is an enhanced version of the ADM3A terminal driver which supports such features as highlighting, etc. The keyboard layout is equivalent to that of the ADM3A.

Appendix E: Emulation of IBM 3278 Model 2 Functions

The standard 3270 functions emulated by the A/C-4 (B) include:

- Cursor control
- Display fields
- Auto-skip capability
- System indicators
- Keyboard functions
- Support for the IBM 3278 Model 2 Display Station

For information regarding use of these functions within an application program, refer to the IBM or application literature.

E.1 Cursor Control

The full range of cursor control and movement is provided by A/C-4 (B) emulation. This includes the cursor-wrap feature which causes the cursor to wrap around to the next line (up or down) when the cursor moves off the edge of the screen.

There is one terminal-specific limitation to cursor positioning. If the A/C-4 (B) is used with a terminal with automatic scrolling, the last character position on the screen (bottom right) is reserved. A character cannot be entered to this screen location, preventing automatic scrolling. See the specific terminal-emulator description to determine if this limitation applies to a given terminal.

E.2 Display Fields

The A/C-4 (B) supports the following display features:

- Input fields, numeric and alphanumeric
- Protected and unprotected fields

- Non-display fields (for passwords, etc.)
- High-intensity data display fields, if supported by the terminal
- 4-color display, if supported by the terminal

E.3 Auto-Skip Capability

The A/C-4 (B) allows for terminal emulation of the auto-skip feature. This capability allows the cursor to skip automatically over protected/numeric fields to be placed at the start of the next input field accessible by you.

E.4 System Indicators

For details of status line support on the A/C-4 (B), see **Chapter 2**.

E.5 Emulated 3278 Keyboard Functions

The A/C-4 (B) emulates the keyboard functions of the IBM 3278 Model 2 Display Station. This is done using a set of terminal-dependent function commands that uniquely identify each supported 3278 keyboard function. Standard 3278 keyboard function commands are described in Table E-1. Refer to the terminal emulator description for the specific implementation of each terminal type supported. For additional information on the 3278 keyboard, see the IBM publication, *IBM 3270 Information Display System Operator's Guide*, document number: GA27-2742.

In addition to emulating the standard keyboard functions of the IBM 3278 Model 2 Display Station, the A/C-4 (B) provides extended functional capabilities not directly associated with standard 3278 keyboards. These are described in **Appendix F**.

Table E-1. Standard 3278 Keyboard Functions.

3278 Function	Description
Reset	Restores keyboard to normal operation after it has been disabled.
Backspace Cursor	Moves cursor left by one column.
Down Cursor	Moves cursor down by one row.
Up Cursor	Moves cursor up by one row.
Forward Space Cursor	Moves cursor right by one column.
Home	Moves cursor to topmost and leftmost unprotected character position.
Tab	Moves cursor to next unprotected field.
Back Tab	Moves cursor to previous unprotected field.
Delete	Deletes character at current cursor position. All following characters shift left one position from the end of the line or the end of the field.
New Line	Moves cursor to first unprotected position of the next line, or thereafter.
Duplicate	Informs a host application program that a duplicate operation is indicated for the current field.
Field Mark	Informs a host application program of the end of a field in an unformatted buffer or subfield in a formatted buffer.
Insert Mode	Places keyboard into insert mode operation.
Erase to End of Field	Erases from current position to end of field.
Erase Input	Erases all unprotected fields.
Enter	Generates an attention request to host to allow transmission of data.
Clear	Generates an attention request to host, causes entire display buffer to be cleared, and moves cursor to HOME position.
Test/Sys Request	Transmits a Test Request message to the host (BSC). Used to switch between SSCP-LU session and either LU-LU session or unowned if no LU-LU session exists (SNA).
PF (1-24)	Program function keys—each generates a unique host attention request (with no data transfer).
PA (1-3)	Program attention keys—each generates a unique host attention request (with no data transfer).
Print	Initiates a local copy function from a keyboard.

Table E-1. Standard 3278 Keyboard Functions.

3278 Function	Description
Cursor Select	Allows the selector-light-pen detection function to be performed from the keyboard.
Attention	Cancels a print ID function.
Device Cancel	Cancels a local copy print request.
Ident	Assigns a printer or printer class for performing a local copy function.
Test	Invokes test functions.

Appendix F: Extended Functions

The A/C-4 (B) provides key commands which extend 3278 keyboard functions. The extended functions are:

- Refresh Screen
- Initialize Terminal
- Numeric Override
- Display Status Line

F.1 Refresh Screen

The key command to refresh screen redisplay the screen. The command is generated by using the refresh screen function key(s). The entire screen buffer stored in the A/C-4 (B) is retransmitted to the screen.

F.2 Initialize Terminal

This key sequence causes the terminal to exit from 3278 emulation mode and to be re-initialized. This is the only log off from the A/C-4 (B). When this sequence is used, the A/C-4 (B) does not send the forced logoff message to the host, if it is so configured. Following terminal initialization, the first two prompts of the connect mode are displayed.

F.3 Numeric Override

This function allows you to key any alphanumeric or special character into a numeric only field. With A/C-4 (B), override remains in effect for the remainder of the selected field.

F.4 Display Status Line

The A/C-4 (B) provides a command that simulates an IBM 3278 status line on the terminal. The display uses standard ASCII characters in the simulation, not the stick characters of the IBM status line.

The IBM 3278 terminal has 25 display lines, with the 25th line as the status line. Most ASCII terminals, however, have only 24 display lines. Therefore, the bottom display line (line 24) is replaced, on command, by status information. The status line must be disabled before data on line 24 can be seen. This is done by repeating the command: "display status line." The command toggles the status display on and off.

For the IBMPC terminal driver, the status line is permanently displayed on the 25th line. Therefore, the display status line command is not required.

When the status line is in effect, the flashing asterisk, used to indicate keyboard lock, is inhibited. See **Section 5.4**.

Appendix G: Terminal Switch Settings

This appendix covers the general requirements for terminals connected to the A/C-4 (B). It is primarily intended for terminals with switch settings not explicitly listed in this manual. Terminal switches must be set to configure the keyboard/CRT with the following characteristics:

- 1.Character mode, as opposed to block or line mode.
- 2.Full duplex.
- 3.Auto new line disabled, if this is a switchable option.
- 4.Auto line feed disabled.
- 5.Cursor addressing on.
- 6.Auto scroll off, if this is a switchable option.
- 7.DTR on, DSR off, DCD on, if they are switchable. If not, then these are already set properly.

- 8.Baud rate, parity, word length, and stop bits set to the same values as on the A/C-4 (B). The easiest to implement is a word length of 8 bits, with 1 stop bit and no parity.

The keyboard must be fully decoupled from the screen, if possible. When a key is pressed, a character should be transmitted to the A/C-4 (B), but the keystroke must not directly change the screen in any way. The A/C-4 (B) must handle any and all screen changes and updates. The keyboard cannot locally affect the display. In some terminals, this is referred to as conversational mode. Therefore, select the conversational mode if there is an option to do so. In some terminals, some keys are always directly coupled to the display, regardless of switch settings. In this case, those keys should not be used. A garbled screen may result, requiring the use of the “refresh screen” command.

G.1 ACT5A Terminal Module—Microterm ACT-5A

How to Set Up the Terminal

To set up the ACT-5A terminal for connection to the A/C-4 (B) in order to emulate the 3278, proceed as follows:

1. Set the Full/Half Duplex switch at the rear of the cabinet to Full Duplex operation.
2. To set the terminal baud rate, set the switch corresponding to the desired baud rate. It is recommended that the highest valid baud rate (matching for both the A/C-4 (B) and the terminal) be selected. If a baud rate of 110 is selected, be sure the number of stop bits specified is 2. The baud rate switches are found on the main logic board.

I/O	Printer	Baud Rate
1	8	19200
2	7	9600
3	6	4800
4	5	2400
5	4	1200
7	2	300
8	1	110

3. There are six switches located on the logic board at the rear of the cabinet which control the terminal's parity, word length and number of stop bits. Set these switches to the following values:

Switch/Option	Value	Comments
8th bit transmit	as desired	OFF = Mark, ON = Space to be transmitted.
6 and 7/Word Length	Length = 8 = 7 = 6 = 5	6 = OFF 7 = OFF 6 = OFF 7 = ON 6 = ON 7 = OFF 6 = ON 7 = ON
8/Odd or Even Parity	as desired	OFF = Even, ON = Odd
9/Number of Stop Bits	ON	Sets the number of stop bits at one. If a baud rate of less than or equal to 110 is being used, set this bit to OFF = two stop bits.
10/Parity	as desired	OFF = No parity, ON = parity selected be switch #8

Keyboard Emulation

Following is a table showing how the Microterm® ACT-5A keyboard is used in emulation of the 3278 keyboard.

NOTES:

1. Press <Ctrl> concurrently with the indicated key.
2. Press <Esc> prior to pressing the indicated key.
3. The last character on the screen (the line-24, column-80 character position) cannot be displayed. This feature is designed to defeat the ACT-5A Auto-Scroll capability.

3278 Function	Key Sequence	Hex Value Generated
Reset	CTRL/R	12H
Backspace Cursor	←	08H
Down Cursor	↓	0BH
Up Cursor	↑	1AH
Forward Space Cursor	→	18H
Home	CTRL/^	1EH
Tab	TAB	09H
Backtab	CTRL/B	02H
Delete	DELETE	7FH
New Line	LINE FEED	0AH
Duplicate	CTRL/D	04H
Field Mark	CTRL/F	06H
Insert Mode	CTRL/U	15H
Erase to End of Field C	TRL/E	05H
Erase Input	CTRL/Y	19H
Enter	RETURN or ENTER	0DH
Clear	ESC ^	1B 5EH
Sys Request	ESC ?	1B 3FH
PF1	ESC 1	1B 31H
PF2	ESC 2	1B 32H
PF3	ESC 3	1B 33H
PF4	ESC 4	1B 34H
PF5	ESC 5	1B 35H
PF6	ESC 6	1B 36H
PF7	ESC 7	1B 37H
PF8	ESC 8	1B 38H
PF9	ESC 9	1B 39H
PF10	ESC 0	1B 30H
PF11	ESC Q	1B 51H
PF12	ESC W	1B 57H
PF13	ESC E	1B 45H
PF14	ESC R	1B 52H
PF15	ESC T	1B 54H
PF16	ESC Y	1B 59H
PF17	ESC U	1B 55H
PF18	ESC I	1B 49H
PF19	ESC O	1B 4FH
PF20	ESC P	1B 50H
PF21	ESC A	1B 41H

3278 Function	Key Sequence	Hex Value Generated
PF22	ESC S	1B 53H
PF23	ESC D	1B 44H
PF24	ESC F	1B 46H
PA1	ESC Z	1B 5AH
PA2	ESC X	1B 58H
PA3	ESC C	1B 43H
Print	CTRL/P	10H
Cursor Select	CTRL/C	03H
Attention	ESC \	1B 5CH
Device Cancel	ESC]	1B 5DH
Ident	ESC :	1B 3AH
Test	ESC ;	1B 3BH
Special Function	Key Sequence	Hex Value Generated
Numeric Override	ESC [1B 5BH
Refresh Screen	CTRL/W	17H
Initialize Terminal	ESC <	1B 3CH
Display Status Line	ESC _ (underline)	1B 5FH

G.2 ADM11 Terminal Module—Lear Siegler ADM-11

To set up the ADM-11 terminal for connection to the converter in order to emulate the 3278 proceed as follows. All operator-selectable variables are input from the keyboard into the Status Line in the ADM-11 Setup Mode; there are no external switches.

1. Connect the terminal to the A/C-4 (B) port (modem or direct cable) as appropriate.
2. For details on how to enter and exit the ADM-11 Setup modes, and how to select the various options, please refer to the ADM-11 User's Reference Manual. Set the options as follows:

Option	Set to:	Comments
CLICK	as desired	Audible keyclick
ONLINE	Y	Online to host computer
CURSOR BLINK	as desired	Cursor blink or steady
STATUS	as desired	Status line display
WRAP	N	No end-of-line wrap
NEWLINE	N	Auto line feed disabled
BPS	as desired	Terminal Baud Rate
BITS	as desired	Data bit length
BIT 8	as desired	Sets eighth bit to 0 or 1
PTY ENABLE	as desired	Parity bit enabled/disabled
PTY	as desired	Parity even or odd
SET DUPLEX MODE	FDX	Full Duplex mode enabled
CHRS/FNC	not available	Reserved for A/C-4 (B) usage
FNC KEYS	not available	Reserved for A/C-4 (B) usage
SO/SI	as desired	Gated Auxiliary mode or keyboard lock/unlock
FREQ	as desired	Refresh rate 50 or 60 Hz
HANDSHAKE	XON	X-ON/X-OFF protocol enabled
XON/XOFF	DC1/DC3	X-ON/X-OFF set to DC1/DC3
BUSY	LO	Active busy DTR signal for auxiliary port set to low
ANSBK	N	Answerback message disabled

Keyboard Emulation

Following is a table showing how the Lear Siegler® ADM-11 keyboard is used in emulation of the 3278 keyboard.

NOTES:

1. Press <Ctrl> concurrently with the indicated key.
2. Press <Esc> prior to pressing the indicated key.
3. The last character on the screen (the line-24, column-80 character position) cannot be displayed. This feature is designed to defeat the Lear Siegler Auto-Scroll capability.

3278 Function	Key Sequence	Hex Value Generated
Reset	CTRL/R	12H
Backspace Cursor	← or BACKSPACE	08H
Down Cursor	↓	0AH
Up Cursor	↑	0BH
Forward Space Cursor	→	0CH
Home	HOME	1EH
Tab	TAB	09H
Backtab	SHIFT/TAB	1B 49H
Delete	DEL	7FH
New Line	CTRL/N	0EH
Duplicate	CTRL/D	04H
Field Mark	CTRL/F	06H
Insert Mode	CTRL/U	15H
Erase to End of Field	ERASE LINE	1B 54H
Erase Input	ERASE PAGE	1B 59H
Enter	RETURN or ENTER	0DH
Clear	ESC Z	1B 5AH
System Request	ESC ?	1B 3FH
PF1	ESC 1	1B 31H
	or F1	01 40 0DH
PF2	ESC 2	1B 32H
	or F2	01 41 0DH
PF3	ESC 3	1B 33H
	or F3	01 42 0DH
PF4	ESC 4	1B 34H
	or F4	01 43 0DH
PF5	ESC 5	1B 35H
	or F5	01 44 0DH
PF6	ESC 6	1B 36H
	or F6	01 45 0DH
PF7	ESC 7	1B 37H
	or F7	01 46 0DH
PF8	ESC 8	1B 38H
	or F8	01 47 0DH
PF9	ESC 9	1B 39H
PF10	ESC 0	1B 30H
PF11	ESC -	1B 2DH
PF12	ESC =	1B 3DH
PF13	ESC !	1B 21H
PF14	ESC @	1B 40H
PF15	ESC #	1B 23H
PF16	ESC \$	1B 24H
PF17	ESC %	1B 25H
PF18	ESC ^	1B 5EH
PF19	ESC &	1B 26H
PF20	ESC *	1B 2AH
PF21	ESC (1B 28H
PF22	ESC)	1B 29H
PF23	ESC _ (underline)	1B 5FH
PF24	ESC +	1B 2BH
PA1	ESC ,	1B 2CH
PA2	ESC .	1B 2EH

A/C-4 (B)

3278 Function	Key Sequence	Hex Value Generated
PA3	ESC /	1B 2FH
Print	PRINT LINE	1B 7AH
Cursor Select	CTRL/C	03H
Attention	ESC \	1B 5CH
Device Cancel	ESC]	1B 5DH
Ident	ESC :	1B 3AH
Test	ESC ;	1B 3BH
Special Function	Key Sequence	Hex Value Generated
Numeric Override	ESC [1B 5BH
Refresh Screen	CTRL/W	17H
Initialize Terminal	ESC <	1B 3CH
Display Status Line	ESC L	1B 4CH

G.3 ADM12 Terminal Module—Lear Siegler ADM-12

To set up the ADM-12 terminal for connection to the A/C-4 (B) in order to emulate the 3278, proceed as follows:

All operator-selectable variables are input from the keyboard into the Status Line in the ADM-12 Setup Mode; there are no external switches.

1. Connect the terminal to the A/C-4 (B) port (modem or direct cable) as appropriate.
2. For details on how to enter and exit the ADM-12 Setup modes, and how to select the various options, please refer to the ADM-12 User's Reference Manual. Set the options as follows:

Option	Set to:	Comments
Keyclick	as desired	Audible keyclick
Status Line Attributes	as desired	
Cursor Blink	as desired	Cursor blink or steady
Cursor Shape	as desired	Block or Underline
Screen Saver	as desired	Auto shut off of display
Smooth Scroll	as desired	Smooth or Jump scroll
Horizontal Scroll	as desired	By line or page
On Line/Local	ONLN	On Line
Page Configuration	as desired	Two or one page
Wrap at Right Margin	NO	No end-of-line wrap
Return key configuration	CR	Return key generates CR character
Block/Conversation	CNV	Conversation Mode
Duplex	FDX	Full Duplex
Handshake protocol	as desired	Set to match logical flow control selection configured for the A/C-4 (B) port
Baud Rate	as desired	Terminal Baud Rate
Parity Select	as desired	Enable or Disable
Parity Type	as desired	Even or Odd
Bit 8	as desired	Bit 8 = 0 or 1

Keyboard Emulation

Following is a table showing how the ADM-12 keyboard is used in emulation of the 3278 keyboard.

NOTES:

1. Press <Ctrl> concurrently with the indicated alpha key.
2. Press <Esc> prior to pressing the indicated alpha key.
3. The last character on the screen (the line 24, column 80 character position) cannot be displayed. This feature is designed to defeat the ADM-12 Auto-Scroll capability.

3278 Function	Key Sequence	Hex Value Generated
Reset	CTRL/R	12H
Backspace Cursor	← or BACKSPACE	08H
Down Cursor	↓	0AH
Up Cursor	↑	0BH
Forward Space Cursor	→	0CH
Home	HOME	1EH
Tab	TAB	09H

3278 Function	Key Sequence	Hex Value Generated
Back Tab	SHIFT/TAB	1B 49H
Delete	DEL or DELETE CHAR	7FH 1B 57H
New Line	NEW LINE	1FH
Duplicate	CTRL/D	04H
Field Mark	CTRL/F	06H
Insert Mode	CHAR INS	1B 51H
Erase to End of Field	ERASE LINE	1B 54H
Erase Input	ERASE PAGE	1B 59H
Enter	RETURN or ENTER	0DH
Clear	F28	01 5B 0DH
Sys Request	F29	01 5C 0DH
PF1	F1	01 40 0DH
PF2	F2	01 41 0DH
PF3	F3	01 42 0DH
PF4	F4	01 43 0DH
PF5	F5	01 44 0DH
PF6	F6	01 45 0DH
PF7	F7	01 46 0DH
PF8	F8	01 47 0DH
PF9	F9	01 48 0DH
PF10	F10	01 49 0DH
PF11	F11	01 4A 0DH
PF12	F12	01 4B 0DH
PF13	F13	01 4C 0DH
PF14	F14	01 4D 0DH
PF15	F15	01 4E 0DH
PF16	F16	01 4F 0DH
PF17	F17	01 50 0DH
PF18	F18	01 51 0DH
PF19	F19	01 52 0DH
PF20	F20	01 53 0DH
PF21	F21	01 54 0DH
PF22	F22	01 55 0DH
PF23	F23	01 56 0DH
PF24	F24	01 57 0DH
PA1	F25	01 58 0DH
PA2	F26	01 59 0DH
PA3	F27	01 5A 0DH
Print	PRINT	1B 50H
Cursor Select	CTRL/C	03H
Attention	F30	01 5D 0DH
Device Cancel	ESC [1B 5DH
Ident	ESC :	1B 3AH
Test	ESC ;	1B 3BH
Special Function	Key Sequence	Hex Value Generated
Numeric Override	ESC [1B 5BH
Refresh Screen	CTRL/W	17H
Initialize Terminal	ESC <	1B 3CH
Display Status Line	ESC _ (underline)	1B 5FH

G.4 ADM178 Terminal Module—Lear Siegler ADM-1178

To set up the ADM-1178 terminal for connection to the A/C-4 (B) in order to emulate the 3278, proceed as follows:

All operator-selectable variables are input from the keyboard into the Status Line in the ADM-1178 Setup Mode; there are no external switches.

1. Connect the terminal to the converter port (modem or direct cable) as appropriate.
2. For details on how to enter and exit the ADM-1178 Setup modes, and how to select the various options, please refer to the ADM-1178 User's Reference Manual. Set the options as follows:

Option	Set to:	Comments
Click	as desired	Audible keyclick
Online	Y	Terminal is on-line to the host computer
Cursor Blink	as desired	Cursor steady or blinking
Status	as desired	Status line is normal or reverse video
Wrap	N	Autowrap disabled
BPS	as desired	BPS = 300, 1200, 2400, 4800, 9600, 19200
Bits	as desired	Seven or eight data bits.
Bit 8	as desired	Eighth data bit set to 0 or 1.
PTY ?	as desired	Parity enabled or disabled.
PTY	as desired	Even or Odd Parity
Duplex	as desired	Half or Full Duplex
HZ	as desired	Vertical Refresh Rate equal to 60 or 50 Hz.
Handshake	as desired	Set to match logical flow control selection configured at converter port.
X-ON/X-OFF	DC1/DC3	If X-ON/X-OFF flow control selected, DC1/DC3 characters used as X-ON/X-OFF
Busy	as desired	Set to match logical-flow-control selection configured at converter port.
Ansbk	N	Disables the terminal's answer-back option.
Numeric	Keypad	Numeric keypad generates numerals and, by use of the ALT key, PF functions
Screen Save Attributes	as desired PAGE	Selected attribute will effect all characters on page to the right of the cursor.
Lock	as desired	Lock will be Alpha Lock Mode or Shift Lock Mode.
Indicate Shift	80	Shift Indicator appears in Col. 80 of the Status Line
Lock	as desired	Keyboard Lock will be local or remote function.
Lock Release	as desired	Keyboard Lock will be released by either the Lock key or the Shift Key.

Keyboard Emulation

Following is a table showing how the Lear Siegler ADM-1178 keyboard is used in emulation of the 3278 keyboard.

NOTES:

1. Press <ALT> concurrently with the indicated key.
2. Press <ESC> prior to pressing the indicated key..
3. The IBM 3278 keyboard, because it is an EBCDIC terminal, does not provide an <ESC> key. The Lear Siegler ADM-1178 provides as an <ESC> key, the key immediately below the <ATTN> key at the left side of the keyboard.
4. The last character on the screen (the line 24, column 80 character position) cannot be displayed. This feature is designed to defeat the Lear Siegler ADM-1178 Auto-Scroll capability.

3278 Function	Key Sequence	Hex Value Generated
Reset	RESET	1B 5FH
Backspace Cursor	← or ←←	08H or 1B 4AH
Down Cursor	↓	0AH
Up Cursor	↑	0BH
Forward Space Cursor	→	0CH
Home	HOME SYMBOL	1EH
Tab	→ I	09H
Backtab	I ←	1B 49H
Delete	DELETE CHAR SYMBOL	7FH
New Line	NEW LINE SYMBOL	1B 5BH
Duplicate	DUP	1B 43H
Field Mark	FIELD MARK	1B 44H
Insert Mode	INSERT SYMBOL	1B 4CH
Erase to End of Field	ERASE EOF	1B 50H
Erase Input	ERASE INPUT	1B 46H
Enter	ENTER	0DH
Clear	CLEAR	1B 53H
Sys Request	SYS REQ	1B 41H
PF1	PF1	1B 60H
PF2	PF2	1B 61H
PF3	PF3	1B 62H
PF4	PF4	1B 63H
PF5	PF5	1B 64H
PF6	PF6	1B 65H
PF7	PF7	1B 66H
PF8	PF8	1B 67H
PF9	PF9	1B 68H
PF10	PF10	1B 69H
PF11	PF11	1B 6AH
PF12	PF12	1B 6BH
PF13	PF13	1B 6CH
PF14	PF14	1B 6DH
PF15	PF15	1B 6EH
PF16	PF16	1B 6FH
FP17	PF17	1B 70H
PF18	PF18	1B 71H

3278 Function	Key Sequence	Hex Value Generated
PF19	PF19	1B 72H
PF20	PF20	1B 73H
PF21	PF21	1B 74H
PF22	PF22	1B 75H
PF23	PF23	1B 76H
PF24	PF24	1B 77H
PA1	PA1	1B 78H
PA2	PA2	1B 79H
PA3	ALT/INSERT SYMBOL	1B 4DH
Print	DISPLAY-PRINT SYMBOL	1B 57H
Cursor Select	CURSOR SEL	1B 42H
Attention	ATTENTION	1B 40H
Device Cancel	DEVICE CANCEL	1B 55H
Ident	IDENT	1B 58H
Test	TEST	1B 59H
Fast Forwardspace	ALT →	1B 5EH
Fast Backspace	ALT ←	!B 60H
Special Function	Key Sequence	Hex Value Generated
Numeric Override	ESC Q	1B 51H
Refresh Screen	ALT/W	17H
Initialize Terminal	ESC <	1B 3CH
Display Status Line	ESC E	1B 45H

G.5 ADM21 Terminal Module—Lear Siegler ADM-21/22/23/24

To set up the ADM-21 terminal for connection to A/C-4 (B) in order to emulate the 3278, proceed as follows:

1. There are 10 toggle-type switches on the terminals back panel labeled as S1 switches. These switches are used to specify terminal operating characteristics. Set these switches in the following manner:

Switch	Set to:	Comments
EDIT-FUNC	FUNC	Sets Alternate mode with edit keys
CURSOR BLINK- CURSOR STEADY	?	Set as desired
CARRIAGE RETURN- NEW LINE function	CARR. RETURN	Disables automatic New Line
PARITY (Sw. 4 and 5)	ODD EVEN MARK SPACE	Sw4 = Down, Sw5 = Down Sw4 = Down, Sw5 = Up Sw4 = Up, Sw5 = Down Sw4 = Up, Sw5 = Up
HALF DUPLEX- FULL DUPLEX	FULL DUPLEX	Full Duplex operation enabled
60HZ - 50 HZ	as required	To match input power frequency
AT4	Switch UP	AT4 not used
CGS1	Switch UP	CGS1 not used
CGS2	Switch DOWN	CGS2 char select option enabled

2. There are 10 toggle-type switches on the terminal back panel labeled as S2 switches. These switches set the baud rate and specify functional terminal operating characteristics. Set these switches in the following manner:

S2 Switch	Set to:	Comments
BAUD RATE (SW. 1-7)	See #3 below for Switch settings	
BUSYDIS-BUSYEN	Busy DIS	Disable BUSY control function
REV VIDEO ON- REV VIDEO OFF	as desired	Set Reverse Video function as desired

3. The remaining switches on the back panel are used to set the baud rate for communication with A/C-4 (B). To set the baud rate, set the switch next to the desired baud rate to the UP position as specified on the ADM-21 back panel (S2) switch group. All other switches must be set to the DOWN position. Note that only one switch is enabled for the desired baud rate unless 110 is to be selected. To set a baud rate of 110, set the following switches to the UP position (Sw. 1, 3, 5, 6, 7, 8) and switches 2 and 4 to the DOWN position.

It is recommended that the highest valid baud rate (matching for both A/C-4 (B) and the terminal) be selected. If a baud rate of 110 is selected, be sure the number of stop bits specified is 2.

4. Connect the terminal to the A/C-4 (B) port (modem or direct cable) as appropriate.

Keyboard Emulation

Following is a table showing how the ADM-21 keyboard is used in emulation of the 3278 keyboard.

NOTES:

1. Press <Ctrl> concurrently with the indicated key.
2. Press <Esc> prior to pressing the indicated key.
3. The second character of the ESC sequence PF key assignments is based on the first two-and-one-half rows of alphanumeric keys being treated as a matrix, thus:

```
row 1 (1 - 0) = PF1 - PF10
row 2 (Q - P) = PF11 - PF20
row 3 (A - F) = PF21 - PF24
```

Similarly, the PA key assignments have, as their second key, the first three characters on the fourth row of alpha keys (Z, X, C). Either lower-case or upper-case (shifted) alpha characters are valid.

4. The last character on the screen (the line-24, column-80 character position) cannot be displayed. This feature is designed to defeat the ADM-21 Auto-Scroll capability.

3278 Function	Key Sequence	Hex Value Generated
Reset	CTRL/R	12H
Backspace Cursor	← or BACKSPACE	08H
Down Cursor	↓	0AH
Up Cursor	↑	0BH
Forward Space Cursor	→	0CH
Home	HOME	1EH
Tab	TAB	09H
Back Tab	SEND PAGE	01 47 0DH
Delete	CHAR DELETE	01 45 0DH
New Line	DEL	7FH
Duplicate	CTRL/D	04H
Field Mark	CTRL/F	06H
Insert Mode	CHAR INSERT or LINE INSERT	01 44 0DH 01 42 0DH
Erase to End of Field	LINE DELETE	01 43 0DH
Erase Input	LINE ERASE	01 40 0DH
Enter	RETURN or RETURN key at right of keypad	0DH 1FH
Clear	PAGE ERASE	01 41 0DH
Syst Request	ESC ?	1B 3FH
PF1	ESC 1	1B 31H
PF2	ESC 2	1B 32H
PF3	ESC 3	1B 33H
PF4	ESC 4	1B 34H
PF5	ESC 5	1B 35H
PF6	ESC 6	1B 36H
PF7	ESC 7	1B 37H
PF8	ESC 8	1B 38H
PF9	ESC 9	1B 39H
PF10	ESC 0	1B 30H

A/C-4 (B)

3278 Function	Key Sequence	Hex Value Generated
PF11	ESC Q	1B 51H
PF12	ESC W	1B 57H
PF13	ESC E	1B 45H
PF14	ESC R	1B 52H
PF15	ESC T	1B 54H
PF16	ESC Y	1B 59H
PF17	ESC U	1B 55H
PF18	ESC I	1B 49H
PF19	ESC O	1B 4FH
PF20	ESC P	1B 50H
PF21	ESC A	1B 41H
PF22	ESC S	1B 53H
PF23	ESC D	1B 44H
PF24	ESC F	1B 46H
PA1	ESC Z	1B 5AH
PA2	ESC X	1B 58H
PA3	ESC C	1B 43H
Print	CTRL/P	10H
Cursor Select	SEND LINE	01 46 0DH
Attention	ESC \	1B 5CH
Device Cancel	ESC]	1B 5DH
Ident	ESC :	1B 3AH
Test	ESC ;	1B 3BH
Special Function	Key Sequence	Hex Value Generated
Numeric Override	ESC [1B 5BH
Refresh Screen	CTRL/W	17H
Initialize Terminal	ESC <	1B 3CH
Display Status Line	ESC _ (underline)	1B 5FH

G.6 ADM24E Terminal Module—Lear Siegler ADM-24E

To set up the ADM-24E terminal for connection to the A/C-4 (B) in order to emulate the 3278, proceed as follows: All operator-selectable variables are input from the keyboard into the Status Line in the ADM-24E Setup Mode; there are no external switches.

1. Connect the terminal to the A/C-4 (B) port (modem or direct cable) as appropriate.
2. For details on how to enter and exit the ADM-24E Setup Mode, and how to select the various options, please refer to the ADM-24E User's Reference Manual. Set the options as follows.

Option	Set to:	Comments
Scroll Method	as desired	Jump or Smooth Scroll
Screen Background	as desired	Normal, Reverse or High-Light
Keyclick	as desired	Audible Keyclick
Return Key Configuration	CR	Return key generates CR character
Scroll Mode	Non-Scroll	Terminal Scroll disabled
Auto New Line	OFF Auto	New Line disabled
Keyboard Configuration	as desired	QY-Type, QWERTZ, AZERTY, or QY-TTY
Primary Language Group	USASCII	Terminal uses US ASCII characters
Line 25 Definition	as desired	Status, F1-F8, F9-F16 or Blank
Line 25 Display	as desired	Normal or Reverse
Audible Bell	as desired	ON or OFF
Number of Lines, Page 1	24	24-line page defined
Number of Lines, Page 2	n.a.	0-24, unused
Function Key Legend No.	as desired	
Typewriter Tabs	as desired	
Tabbing Mode	as desired	Typewriter or Protected Field
International Language	as desired	Alternate character generation mode
Attributes	Non-embedded	
Send/Print Attributes	Non-embedded	
Edit Key Sequence	ON	Edit keys transmit to host
Transmission		
Null Suppression	ON	
DEL Suppression	OFF	DEL character transmitted to host
Fill Character #1	Space	Clear screen function fills screen with spaces
Fill Character #2-#8	as desired	Full Duplex mode
Parity (Host)	as desired	Odd, Even, Mark Space or None
Busy/Ready Indicator	as desired	Set to match logical flow control selection configured for the A/C-4 (B) port
Baud Rate (Host)	as desired	Main port baud rate
X-ON Character (Host)	DC1	
X-OFF Character (Host)	DC3	
Parity (Printer)	as desired	Odd, Even, Mark, Space or None
Busy/Ready Indicator	as desired	Set to match logical (Printer) flow control selection configured for printer device
Printer Busy	as desired	Low or High
Baud Rate (Printer)	as desired	Printer port baud rate
Print Buffer Size	0	
X-ON Character (Printer)	DC1	
X-OFF Character (Printer)	DC3	
User Program Present (P1 and P2)	as desired	To run customer firmware

Option	Set to:	Comments
Line frequency	as required	50 Hz or 60 Hz
Data Transmission Mode	Conversation	Conversation mode
Answerback	as desired	ON or OFF
Answerback Message	as desired	
Screen Save	as desired	Auto shut-off of display
Fill 5 Placement	as desired	Before or After

Keyboard Emulation

Following is a table showing how the ADM-24E keyboard is used in emulation of the 3278 keyboard.

NOTES:

1. Press <Ctrl> concurrently with the indicated key.
2. Press <Esc> prior to pressing the indicated key.

3278 Function	Key Sequence	Hex Value Generated
Reset	CTRL/R	12H
Backspace Cursor	← or BACKSPACE	08H
Down Cursor	↓ or LINEFEED	0AH
Up Cursor	↑	0BH
Forward Space Cursor	→	0CH
Home	HOME	1EH
Tab	TAB	09H
Back Tab	SHIFT/TAB	1B 49H
Delete	DEL or DELETE CHAR	7FH or 1B 57H
New Line	NEW LINE	1FH
Duplicate	CTRL/D	04H
Field Mark	CTRL/F	06H
Insert Mode	CHAR INS	1B 51H
Erase to End of Field	ERASE LINE	1B 54H
Erase Input	ERASE PAGE	1B 59H
Enter	RETURN (OR ENTER)	0DH
Clear	F28	01 6B 0DH
Sys Request	F29	01 6C 0DH
PF1	F1	01 40 0DH
PF2	F2	01 41 0DH
PF3	F3	01 42 0DH
PF4	F4	01 43 0DH
PF5	F5	01 44 0DH
PF6	F6	01 45 0DH
PF7	F7	01 46 0DH
PF8	F8	01 47 0DH
PF9	F9	01 48 0DH
PF10	F10	01 49 0DH
PF11	F11	01 4A 0DH
PF12	F12	01 4B 0DH
PF13	F13	01 4C 0DH
PF14	F14	01 4D 0DH
PF15	F15	01 4E 0DH

278 Function	Key Sequence	Hex Value Generated
PF16	F16	01 4F 0DH
PF17	F17	01 60 0DH
PF18	F18	01 61 0DH
PF19	F19	01 62 0DH
PF20	F20	01 63 0DH
PF21	F21	01 64 0DH
PF22	F22	01 65 0DH
PF23	F23	01 66 0DH
PF24	F24	01 67 0DH
PA1	F25	01 68 0DH
PA2	F26	01 69 0DH
PA3	F27	01 6A 0DH
Print	SEND LINE or ESC P	1B 34H 1B 50H
Cursor Select	CTRL/C	03H
Attention	F30	01 6D 0DH
Device Cancel	ESC]	1B 5DH
Ident	ESC :	1B 3AH
Test	ESC ?	1B 3FH
Special Function	Key Sequence	Hex Value Generated
Numeric Override	ESC [1B 5BH
Refresh Screen	CTRL/W	17H
Initialize Terminal	ESC <	1B 3CH
Display Status Line	ESC _ (underline)	1B 5FH

G.7 ADM2D Terminal Module—Lear Siegler ADM-21

To set up the ADM-21 terminal for connection to the A/C-4 (B) in order to emulate the 3278, proceed as follows:

1. There are 10 toggle-type switches on the terminals back panel labeled as S1 switches. These switches are used to specify terminal operating characteristics. Set these switches in the following manner:

Switch	Set to:	Comments
EDIT-FUNC	FUNC	Sets Alternate mode with edit keys
CURSOR BLINK- CURSOR STEADY	?	Set as desired
CARRIAGE RETURN- NEW LINE	CARR. RETURN	Disables automatic New Line function.
PARITY (Sw. 4 and 5)	ODD EVEN MARK SPACE	Sw4 = Down, Sw5 = Down Sw4 = Down, Sw5 = Up Sw4 = Up, Sw5 = Down Sw4 = Up, Sw5 = Up
HALF DUPLEX FULL DUPLEX	FULL DUPLEX	Full Duplex operation enabled
60HZ - 50 HZ	as required	To match input power frequency
AT4	Switch UP	AT4 not used
CGS1	Switch UP	CGS1 not used
CGS2	Switch DOWN	CGS2 char select option enabled.

2. There are 10 toggle-type switches on the terminal back panel labeled as S2 switches. These switches set the baud rate and specify functional terminal operating characteristics. Set these switches in the following manner:

S2 Switch	Set to:	Comments
BAUD RATE (SW. 1-7)		See #3 below for Switch settings
BUSYDIS-BUSYEN	Busy DIS	Disable BUSY control function
REV VIDEO ON- REV VIDEO OFF	as desired	Set Reverse Video function as desired.

3. The remaining switches on the back panel are used to set the baud rate for communication with the A/C-4 (B). To set the baud rate, set the switch next to the desired baud rate to the UP position as specified on the ADM-21 back panel (S2) switch group. All other switches must be set to the DOWN position. Note that only one switch is enabled for the desired baud rate unless 110 is to be selected. To set a baud rate of 110, set the following switches to the UP position (Sw. 1, 3, 5, 6, 7, 8) and switches 2 and 4 to the DOWN position.

It is recommended that the highest valid baud rate (matching for both the A/C-4 (B) and the terminal) be selected. If a baud rate of 110 is selected, be sure the number of stop bits specified is 2.

4. Connect the terminal to the A/C-4 (B) port (modem or direct cable) as appropriate.

Keyboard Emulation

Following is a table showing how the ADM-21 Order Entry keyboard is used in emulation of the 3278 keyboard.

NOTES:

1. Press <Ctrl> concurrently with the indicated key.
2. Press <Esc> prior to pressing the indicated key.
3. The second character of the ESC sequence PF key assignments is based on the first two-and-one-half rows of alphanumeric keys being treated as a matrix, thus:
 - row 1 (1 - 0) = PF1 - PF10
 - row 2 (Q - P) = PF11 - PF20
 - row 3 (A - F) = PF21 - PF24
4. The last character on the screen (the line 24, column 80 character position) cannot be displayed. This feature is designed to defeat the ADM-21 Auto-Scroll capability.
5. Terminal requires special keytop set.

3278 Function	Key Sequence	Hex Value Generated
Reset	CTRL/R or RESET	12H 01 41 0DH
Backspace Cursor	← or BACKSPACE	08H
Down Cursor	↓	0AH
Up Cursor	↑	0BH
Forward Space Cursor	→	0CH
Home	CTRL/^	1EH
Tab	TAB	09H
Back Tab	BACKTAB	01 47 0DH
Delete	CHAR DELETE or DEL	01 45 0DH 7FH
New Line	NEW LINE	5CH
Duplicate	CTRL/D	04H
Field Mark	CTRL/F	06H
Insert Mode C	HAR INSERT	01 44 0DH
Erase to End of Field	ERASE EOF	01 46 0DH
Erase Input	CTRL/X	18H
Enter	RETURN/ENTER	0DH
Clear	CLEAR	01 40 0DH
Sys Request	ESC ?	1B 3FH
PF1	ESC 1	1B 31H
PF2	ESC 2	1B 32H
PF3	ESC 3	1B 33H
PF4	ESC 4	1B 34H
PF5	ESC 5	1B 35H
PF6	ESC 6	1B 36H
PF7	ESC 7	1B 37H
PF8	ESC 8	1B 38H
PF9	ESC 9	1B 39H
PF10	ESC 0	1B 30H

A/C-4 (B)

3278 Function	Key Sequence	Hex Value Generated
PF11	ESC Q or ESC -	1B 51H 1B 5FH
PF12	ESC W or ESC =	1B 57H 1B 3DH
PF13	ESC E	1B 45H
PF14	ESC R	1B 52H
PF15	ESC T	1B 54H
PF16	ESC Y	1B 59H
PF17	ESC U	1B 55H
PF18	ESC I	1B 49H
PF19	ESC O	1B 4FH
PF20	ESC P	1B 50H
PF21	ESC A	1B 41H
PF22	ESC S	1B 53H
PF23	ESC D	1B 44H
PF24	ESC F	1B 46H
PA1	PA1	01 60 0DH
PA2	PA2	01 61 0DH
PA3	PA3	01 62 0DH
Print	PRINT SCREEN	01 43 0DH
Cursor Select	CTRL/C	03H
Attention	ESC \	1B 5CH
Device Cancel	ESC]	1B 5DH
Ident	ESC :	1B 3AH
Test	ESC ;	1B 3BH
Special Function	Key Sequence	Hex Value Generated
Numeric Override	ESC [1B 5BH
Refresh Screen	SCREEN REFRESH	01 42 0DH
Initialize Terminal	ESC <	1B 3CH
Display Status Line	ESC _ (underline)	1B 5FH

G.8 ADM3A Terminal Module—Lear Siegler ADM-3A

To set up the ADM-3A terminal for connection to the A/C-4 (B) in order to emulate the 3278, proceed as follows:

1. Disconnect the AC power cord from the outlet before opening the ADM-3A case.
2. There are 13 toggle-type switches on the terminal’s circuit board. These switches are used to specify terminal operating characteristics. Set these switches in the following manner:

Switch	Set to:	Comments
SPACE-ADV	SPACE	Destructive cursor
UC DISP-U/L DISP	U/L DISP	Allows display of upper and ower case characters (if terminal has this option)
DISABLE-KB LOCK KB	LOCK	Allows keyboard lock
DISABLE-CLR SCRN	CLR SCRN	Clear Screen position
50 HZ - 60 HZ	?	To match input power frequency
12 LINE-24 LINE	24 LINE	24 line display
CUR CTL-OFF	CUR CTL	Specify cursor control
LOCAL-OFF	?	Set as appropriate
103-OFF	?	Set as appropriate
202-OFF	OFF	Half-duplex I/O not allowed
CODE-SEC		Active only if 202 is on
ETX-OFF	OFF	Off since 202 is off
EOT-OFF	OFF	Off since 202 is off

3. There are 20 toggle-type switches on the ADM-3A front panel. These switches are used to specify the terminal’s primary operating characteristics and may be accessed by removing (unscrewing) the identification plate on the keyboard. Set these switches in the following manner:

Switch	Set to:	Comments
BIT8 - 0/1	0	Forces bit 8 to zero. Set this switch only if parity is not set (this switch and PARITY switch are mutually exclusive).
PARITY-INH	?	If parity is to be set, set parity; otherwise, set to INH. Parity is set to match parity for the A/C-4 (B) port. If no parity, set Bit 8.
STOP 1-2	?	Set as appropriate. A/C-4 (B) assumes 1, except at baud of 110, when 2 is assumed. DATA
7-8	8	8-bit data word length
PAR-ODD-EVEN	?	This switch has effect only with the PARITY-INH switch in the PARITY position. If PARITY is on, select parity to match the parity on the A/C-4 (B) port for this CRT.
LC EN-UC	EN	Allows lower and upper case
AUTO NL-OFF	OFF	Disables auto NEW LINE
RS232-CL	RS232	Selects RS-232C communications at the modem connector on the rear panel
HDX-FDX	FDX	Full-duplex operation

A/C-4 (B)

- The remaining switches on the front panel are used to set the baud rate for communication with A/C-4 (B). To set the baud rate, set the switch next to the desired baud rate to the left-hand position. All other baud switches must be set on the right-hand side; that is, set one switch only. The baud rate specified here must match the baud rate specified for the A/C-4 (B) port to which this terminal is connected. It is recommended that the highest valid baud rate (matching for both the A/C-4 (B) and the terminal) be selected. If a baud rate of 110 is selected, be sure the number of stop bits specified is 2.
- Replace the cover, reconnect the AC power cord and connect the terminal to the A/C-4 (B) port (or modem, etc.) as appropriate.

Keyboard Emulation

Following is a table showing how the ADM-3A keyboard is used in emulation of the 3278 keyboard.

NOTES:

- Press <Ctrl> concurrently with the indicated key.
- Press <Esc> prior to pressing the indicated key.
- The second character of the ESC sequence PF key assignments is based on the first two-and-one-half rows of alphanumeric keys being treated as a matrix, thus:

row 1 (1 - 0) = PF1 - PF10
row 2 (Q - P) = PF11 - PF20
row 3 (A - F) = PF21 - PF24

Similarly, the PA key assignments have, as their second key, the first three characters on the fourth row of alpha keys (Z, X, C). Either lower-case or upper-case (shifted) alpha characters are valid.

3278 Function	Key Sequence	Hex Value Generated
Reset	CTRL/R	12H
Backspace Cursor	CTRL/H	08H
Down Cursor	LINE FEED	0AH
Up Cursor	CTRL/K	0BH
Forward Space Cursor	CTRL/L	0CH
Home	CTRL/^	1EH
Tab	CTRL/T	14H
	or CTRL/I	09H
Back Tab	CTRL/B	02H
Delete	RUB	7FH
	or ESC +	1B 2BH
New Line	CTRL/N	0EH
Duplicate	CTRL/D	04H
Field Mark	CTRL/F	06H
Insert Mode	CTRL/U	15H
Erase to End of Field	CTRL/E	05H
Erase Input	CTRL/X	18H
Enter	RETURN	0DH
Clear	ESC ^	1B 5EH
System Request	ESC ?	1B 3FH
PF1	ESC 1	1B 31H
PF2	ESC 2	1B 32H
PF3	ESC 3	1B 33H
PF4	ESC 4	1B 34H
PF5	ESC 5	1B 35H

3278 Function	Key Sequence	Hex Value Generated
PF6	ESC 6	1B 36H
PF7	ESC 7	1B 37H
PF8	ESC 8	1B 38H
PF9	ESC 9	1B 39H
PF10	ESC 0	1B 30H
PF11	ESC Q	1B 51H
	or ESC -	1B 2DH
PF12	ESC W	1B 57H
	or ESC =	1B 3DH
PF13	ESC E	1B 45H
PF14	ESC R	1B 52H
PF15	ESC T	1B 54H
PF16	ESC Y	1B 59H
PF17	ESC U	1B 55H
PF18	ESC I	1B 49H
PF19	ESC O	1B 4FH
PF20	ESC P	1B 50H
PF21	ESC A	1B 41H
PF22	ESC S	1B 53H
PF23	ESC D	1B 44H
PF24	ESC F	1B 46H
PA1	ESC Z	1B 5AH
PA2	ESC X	1B 58H
PA3	ESC C	1B 43H
Print	CTRL/P	10H
Cursor Select	CTRL/C	03H
Attention	ESC \	1B 5CH
Device Cancel	ESC]	1B 5DH
Ident	ESC :	1B 3AH
Test	ESC ;	1B 5FH
Special Function	Key Sequence	Hex Value Generated
Numeric Override	ESC [1B 5BH
Refresh Screen	CTRL/W	17H
Initialize Terminal	ESC <	1B 3CH
Display Status Line	ESC _ (underline)	1B 5FH

G.9 ADM3P Terminal Module—Lear Siegler ADM-3P

To set up the ADM-3P terminal for connection to the A/C-4 (B), proceed as follows:

1. Disconnect the AC power cord from the outlet before opening the case.
2. There are 13 toggle-type switches on the terminal’s circuit board. These switches are used to specify terminal operating characteristics. Set these switches in the following manner:

Switch	Set to:	Comments
SPACE-ADV	SPACE	Destructive cursor
UC DISP-U/L DISP	U/L DISP	Allows display of upper- and lower-case characters (if terminal has this option)
DISABLE-KB LOCK	KB LOCK	Allows keyboard lock
DISABLE-CLR SCRN	CLR SCRN	Clear Screen position
50 HZ - 60 HZ	as required	To match input power frequency
12 LINE-24 LINE 24	LINE 24	line display
CUR CTL-OFF	CUR CTL	Specify cursor control
LOCAL-OFF	as desired	Set as is appropriate
103-OFF	as desired	Set as is appropriate
202-OFF OFF	Half-duplex	I/O not allowed
CODE-SEC		Active only if 202 is on
ETX-OFF	OFF	Off since 202 is off
EOT-OFF	OFF	Off since 202 is off

3. There are 20 toggle-type switches on the front panel. These switches are used to specify the terminal’s primary operating characteristics and may be accessed by removing (unscrewing) the identification plate on the keyboard. Set these switches in the following manner:

Switch	Set to:	Comments
BIT8 - 0/1	0	Forces bit 8 to zero. Set this switch only if parity is not set; that is, this switch and a PARITY switch are mutually exclusive.
PARITY-INH	as required	If parity is to be set, set Parity; otherwise, set to INH. Parity is set to match parity for the A/C-4 (B) port. If no parity, set Bit 8.
STOP 1-2	as desired	Set as appropriate. A/C-4 (B) assumes 1, except at baud of 110, when 2 is assumed.
DATA 7-8	8	8-bit data word length
PAR-ODD-EVEN	as desired	This switch has effect only with the PARITY-INH switch in the PARITY position. If PARITY is on, select parity to match the parity on the A/C-4 (B) port for this CRT.
LC EN-UC	EN	Allows lower and upper case
AUTO NL-OFF	OFF	Disables auto NEW LINE
S232-CL	RS232	Selects RS-232C communications at the modem connector on the rear panel
HDX-FDX	FDX	Full-duplex operation

4. The remaining switches on the front panel are used to set the baud rate for communication with the A/C-4 (B). To set the baud rate, set the switch next to the desired baud rate to the left-hand position. All other baud switches must be set on the right-hand side; that is, set one switch only. The baud rate specified here must match the baud rate specified for the port to which this terminal is to be connected. It is recommended that the highest valid baud rate (matching for both the A/C-4 (B) and the terminal) be selected. If a baud rate of 110 is selected, be sure the number of stop bits specified is 2.
5. Replace the cover, reconnect the AC power cord and connect the terminal to the A/C-4 (B) port (or modem, etc.), as is appropriate.

Keyboard Emulation

Following is a table showing how the ADM-3P keyboard is used in emulation of the 3278 keyboard.

NOTES:

1. Press <Ctrl> concurrently with the indicated key.
2. Press <Esc> prior to pressing the indicated key.
3. The second character of the ESC sequence PF key assignments is based on the first two-and-one-half rows of alphanumeric keys being treated as a matrix, thus:

row 1 (1 - 0) = PF1 - PF10
row 2 (Q - P) = PF11 - PF20
row 3 (A - F) = PF21 - PF24

Similarly, the PA key assignments have, as their second key, the first three characters on the fourth row of alpha keys (Z, X, C). Either lower-case or upper-case (shifted) alpha characters are valid.

3278 Function	Key Sequence	Hex Value Generated
Reset	CTRL/R	12H
Backspace Cursor	CTRL/H	08H
Down Cursor	LINE FEED	0AH
Up Cursor	CTRL/K	0BH
Forward Space Cursor	CTRL/L	0CH
Home CTRL/^	1EH	
Tab CTRL/T	14H	
	or CTRL/I	09H
Back Tab	CTRL/B 02H	
Delete	RUB 7FH	
	or ESC +	1B 2BH
New Line	CTRL/N	0EH
Duplicate	CTRL/D	04H
Field Mark	CTRL/F	06H
Insert Mode	CTRL/U	15H
Erase to End of Field	CTRL/E	05H
Erase Input	CTRL/X	18H
Enter	RETURN	0DH
Clear	ESC ^	1B 5EH
System Request	ESC ?	1B 3FH
PF1	ESC 1	1B 31H
PF2	ESC 2	1B 32H
PF3	ESC 3	1B 33H
PF4	ESC 4	1B 34H
PF5	ESC 5	1B 35H

A/C-4 (B)

3278 Function	Key Sequence	Hex Value Generated
PF6	ESC 6	1B 36H
PF7	ESC 7	1B 37H
PF8	ESC 8	1B 38H
PF9	ESC 9	1B 39H
PF10	ESC 0	1B 30H
PF11	ESC Q	1B 51H
	or ESC -	1B 2DH
PF12	ESC W	1B 57H
	or ESC =	1B 3DH
PF13	ESC E	1B 45H
PF14	ESC R	1B 52H
PF15	ESC T	1B 54H
PF16	ESC Y	1B 59H
PF17	ESC U	1B 55H
PF18	ESC I	1B 49H
PF19	ESC O	1B 4FH
PF20	ESC P	1B 50H
PF21	ESC A	1B 41H
PF22	ESC S	1B 53H
PF23	ESC D	1B 44H
PF24	ESC F	1B 46H
PA1	ESC Z	1B 5AH
PA2	ESC X	1B 58H
PA3	ESC C	1B 43H
Print	CTRL/P	10H
Cursor Select	CTRL/C	03H
Attention	ESC \	1B 5CH
Device Cancel	ESC]	1B 5DH
Ident	ESC :	1B 3AH
Test	ESC ;	1B 5FH
Special Function	Key Sequence	Hex Value Generated
Numeric Override	ESC [1B 5BH
Refresh Screen	CTRL/W	17H
Initialize Terminal	ESC <	1B 3CH
Display Status Line	ESC _ (underline)	1B 5FH

G.10 ANSI Terminal Module—ANSI Standard 3.64

Information on the setup of any terminal complying to ANSI Standard, 3.64 will depend on the particular terminal being used. Please refer to the manufacturer’s user’s manual and the General Notes on Terminal Switch Settings section of the Introduction to this document for the proper settings, or contact your supplier.

Keyboard Emulation

Following is a table showing how an ANSI Standard 3.64 keyboard is used in emulation of the 3278 keyboard.

NOTES:

1. Press <Ctrl> concurrently with the indicated key.
2. Press <Esc> prior to pressing the indicated key.

3278 Function	Key Sequence	Hex Value Generated
Reset	CTRL/R	12H
Backspace Cursor	←	1B 5B 44H
Down Cursor	↓	1B 5B 42H
Up Cursor	↑	1B 5B 41H
Forward Space Cursor	→	1B 5B 43H
Home	CTRL/^	1EH
Tab	TAB	09H
Back Tab	BACKSPACE	08H
Delete	DELETE	7FH
New Line	LINE FEED	0AH
Duplicate	CTRL/D	04H
Field Mark	CTRL/F	06H
Insert Mode	CTRL/U	15H
Erase to End of Field	CTRL/E	05H
Erase Input	CTRL/X	18H
Enter	RETURN	0DH
Clear	CTRL/Z	1AH
Test Request	ESC ?	1B 3FH
PF1	ESC 1	1B 31H
	or PF1	1B 4F 50H
PF2	ESC 2	1B 32H
	or PF2	1B 4F 51H
PF3	ESC 3	1B 33H
	or PF3	1B 4F 52H
PF4	ESC 4	1B 34H
	or PF4	1B 4F 53H
PF5	ESC 5	1B 35H
PF6	ESC 6	1B 36H
PF7	ESC 7	1B 37H
PF8	ESC 8	1B 38H
PF9	ESC 9	1B 39H
PF10	ESC 0	1B 30H
PF11	ESC !	1B 21H
	or ESC -	1B 2DH

A/C-4 (B)

3278 Function	Key Sequence	Hex Value Generated
PF12	ESC @ or ESC =	1B 40H 1B 3DH
PF13	ESC #	1B 23H
PF14	ESC \$	1B 24H
PF15	ESC %	1B 25H
PF16	ESC ^	1B 5EH
PF17	ESC &	1B 26H
PF18	ESC *	1B 2AH
PF19	ESC (1B 28H
PF20	ESC)	1B 29H
PF21	ESC ESC 1	1B 1B 31H
PF22	ESC ESC 2	1B 1B 32H
PF23	ESC ESC 3	1B 1B 33H
PF24	ESC ESC 4	1B 1B 34H
PA1	ESC Z	1B 5AH
PA2	ESC X	1B 58H
PA3	ESC C	1B 43H
Print	CTRL/P	10H
Cursor Select	CTRL/C	03H
Attention	ESC \	1B 5CH
Device Cancel	ESC]	1B 5DH
Ident	ESC :	1B 3AH
Test	ESC ;	1B 3BH
Special Function	Key Sequence	Hex Value Generated
Numeric Override	ESC {	1B 7BH
Refresh Screen	CTRL/W	17H
Initialize Terminal	ESC <	1B 3CH
Display Status Line	ESC _ (underline)	1B 5FH

G.11 C108 Terminal Module—HDS Concept 108/APL8

How to Set Up the Terminal

To set up the Human Designed Systems Concept 108/APL8 terminal for connection to the A/C-4 (B) in order to emulate the 3278, proceed as follows.

All operator-selectable options are input either from the host or the terminal’s keyboard into the Programmer Mode Status Lines; there are no external switches.

1. Connect the terminal to the A/C-4 (B) port (modem or direct cable) as appropriate.
2. There are numerous Status Lines available on the Concept 108/APL8. We will be concerned with the Keyboard Line (abbreviated KB) and Line 1 (1). The terminal must be configured such that Line 1 input/output port is used for connection to the A/C-4 (B). Status Lines are viewed by pressing the STAT key and are scrolled (that is, changing the display from KB line to L1 line) by entering from the keyboard the sequence MULT CODE, SPACE, d (scroll forward) or D (scroll backward).
3. Enter Programmer Mode by entering the sequence MULT CODE, U. Enter Full Duplex Mode by entering the sequence MULT CODE, 8. To set the baud rate, parity, and number of stop bits for KB, and L1, refer to the charts below. Note that all changes to KB also change L1, and vice versa.

Option/Port [/KB/L1]	Key Sequence	
Baud	MULT CODE O baud character	
	Baud Character	Baud Rate
	“	110
	%	300
	‘	1200
	*	2400
	,	4800
	.	9600
Parity	MULT CODE P parity character	
	Parity Character	Parity
	!	EVEN
	“	ODD
	#	MARK
	\$	SPACE
Stop bits	MULT CODE SPACE stop character	
	Stop Character	Stop Bits
	!	1
	“	2

4. All other relevant selectable options are set by the A/C-4 (B) terminal-initialization sequence. These include Full Duplex, Auto Line Feed Off, Remote Mode, Transmit Mode, Character Mode, reassignment of Edit Key generation, etc. Any further option selection by you may have an adverse effect on terminal or A/C-4 (B) operation.

Keyboard Emulation

Following is a table showing how the HDS™ Concept 108/APL8 keyboard is used in emulation of the 3278 keyboard.

NOTES:

1. Press <Ctrl> concurrently with the indicated key.
2. Press <Esc> prior to pressing the indicated key.
3. The second character of the ESC sequence PF key assignments is based on the first two-and-one-half rows of alphanumeric keys being treated as a matrix, thus:

row 1 (1 - 0) = PF1 - PF10
 row 2 (Q - P) = PF11 - PF20
 row 3 (A - F) = PF21 - PF24

Similarly, the PA key assignments have, as their second key, the first three characters on the fourth row of alpha keys (Z, X, C). Either lower- or upper-case (shifted) alpha characters are valid.

3278 Function	Key Sequence	Hex Value Generated
Reset	RESET	1B 2CH
Backspace Cursor	← or BACKSPACE	1B 3EH 08H
Down Cursor	↓	1B 3CH
Up Cursor	↑	1B 3BH
Forwardspace Cursor	→	1B 3DH
Home	HOME	1B 3FH
Tab	TAB	09H
Backtab	BACKTAB	1B 60H
Delete	RUBOUT or DEL CHAR	7FH 1B 48H
New Line	LINE FEED	0AH
Duplicate	F1	1C 35H
Field Mark	F2	1C 36H
Insert Mode	INSRT	1B 47H
Erase to End of Field	CLEAR EOP/EOL	1B 4BH
Erase to Input	LINE DEL/INS	1B 4AH
Enter	RETURN	0DH
Clear	F3	1C 37H
Sys Request	STAT	1B 2BH
PF1	ESC 1	1B 31H
PF2	ESC 2	1B 32H
PF3	ESC 3	1B 33H
PF4	ESC 4	1B 34H
PF5	ESC 5	1B 35H
PF6	ESC 6	1B 36H
PF7	ESC 7	1B 37H
PF8	ESC 8	1B 38H
PF9	ESC 9	1B 39H
PF10	ESC 0	1B 30H
PF11	ESC Q	1B 51H
PF12	ESC W	1B 57H
PF13	ESC E	1B 45H

3278 Function	Key Sequence	Hex Value Generated
PF14	ESC R	1B 52H
PF15	ESC T	1B 54H
PF16	ESC Y	1B 59H
PF17	ESC U	1B 55H
PF18	ESC I	1B 49H
PF19	ESC O	1B 4FH
PF20	ESC P	1B 50H
PF21	ESC A	1B 41H
PF22	ESC S	1B 53H
PF23	ESC D	1B 44H
PF24	ESC F	1B 46H
PA1	ESC Z	1B 5AH
PA2	ESC X	1B 58H
PA3	ESC C	1B 43H
Print	PRINT	1B 7BH
Cursor Select	SEND	1B 4CH
Attention	ESC V	1B 56H
Device Cancel	TAB SET/CLR	1B 5DH
Ident	ESC B	1B 42H
Test	ESC N	1B 4EH
Special Function	Key Sequence	Hex Value Generated
Numeric Override	SCROLL	1B 5BH
Refresh Screen	TAPE	1B 27H
Initialize Terminal	SHIFT/SCROLL	1B 5CH
Display Status Line	ESC M	1B 4DH

G.12 C530 Terminal Module—Soroc Challenger 530

To set up the Soroc Challenger 530 terminal for connection to the A/C-4 (B) in order to emulate the 3278, proceed as follows.

All operator selectable options are input from the keyboard through the C530 Intelligent Flexibility feature; there are no external switches.

1. Connect the terminal to the converter port (modem or direct cable) as appropriate.
2. For details on how to access Intelligent Flexibility, to view current settings or to change those settings, please refer to the Challenger 530 Operator’s Guide. Set the terminal’s characteristics as follows:

NOTE:

Some of the terminal’s characteristics are set/reset by the A/C-4 (B) terminal-initialization sequence, and user definitions are therefore irrelevant.

Item Number	Value (in decimal)	Comments
00	27	ESC as lead-in character
01, 02	as desired	SEND LINE/PAGE/MSG end indication character(s)
03, 04	as desired	End of Line indication character(s)
05, 06	as desired	Skip Protected Field indication character(s)
07, 08	as desired	Start Protected Field indication character(s)
09, 10	as desired	End Protected Field indication character(s)
11	as desired	Start of Message character
12	as desired	End of Message character
13	as desired	Block Mode Pad character
14, 15	as desired	Formatted Print delimiter characters.
16	as desired	Number of Null characters sent after print delimiter
17	as desired	Printer Internal Delay time
18	as desired	Keyboard Repeat Rate
19	as desired	Break key time duration
20	as desired	RTS Trailing Edge delay
21, 22	19, 20	Transparent Aux. Port ON and OFF character codes: set by A/C-4 (B)
23	14	SO (=CTRL/N) as Intelligent Flexibility and Programmable key termination character
24		Not used
25	as required	00 = 60 Hz / 01 = 50 Hz
26	as desired	00 = Power on in Conversation Mode 01 = Power on in Block Mode
27	00	Full Duplex when in Conversation Mode: set by A/C-4 (B)

APPENDIX G: Terminal Switch Settings

Item Number	Value (in decimal)	Comments
28	01	Programmable Function mode for numeric keypad: set by A/C-4 (B)
29	as desired	00 = Keyclick disable 01 = Keyclick enable
30	as desired	00 = Audible Alarm disable 01 = Audible Alarm enable
31	as desired	00 = Break key disable 01 = Break key enable
32	as desired	00 = Status Line disable 01 = Status Line enable
33	as desired	00 = Internal Printer Delay disable 01 = Internal Printer Delay enable
34	01	Transparent Aux. Port enable: set by A/C-4 (B)
35	as desired	00 = Request-To-Send controlled 01 = Request-To-Send not controlled
36	as desired	00 = Block Mode Pad chars. enable 01 = Block Mode Pad chars. disable
37	as desired	00 = Power on with Aux. Port disabled 01 = Power on with Aux. Port enabled
38	as desired	00 = Protected data skipped 01 = Protected data printed during a Formatted Print
39	as desired	Set to match logical flow control selection configured for A/C-4 (B) port
40	00 01	Any code interpreted as X-ON 41 CTRL/Z interpreted as Clear Screen command
42	as desired	00 = Full Duplex Keyboard disable 01 = Full Duplex Keyboard enable
43	as desired	00 = Function Key Message Delay disable 01 = Function Key Message Delay enable
44	00	RS-232C Communication
45-48		Not used

Item Number

49 - Computer Port Word Configuration (see table below)

51 - Printer Port Word Configuration (see table below)

Value	Parity	Data/stop bits
00	No	7/1
01	No	7/2
02	Odd	7/1
03	Odd	7/2
04	Even	7/1
05	Even	7/2
06	Zero	7/1
07	Zero	7/2
08	One	7/1
09	One	7/2

50 - Computer Port Baud Rate (see table below)

52 - Printer Port Baud Rate (see table below)

Value	Baud
03	110
06	300
08	1200
11	2400
12	4800
13	9600
14	19200

Keyboard Emulation

Following is a table showing how the Soroc Challenger 530 keyboard is used in emulation of the 3278 keyboard.

NOTES:

1. Press <Ctrl> concurrently with the indicated key.
2. Press <Esc> prior to pressing the indicated key.
3. The second character of the ESC sequence PF key assignments is based on the first two-and-one-half rows of alphanumeric keys being treated as a matrix, thus:

row 1 (1 - 0) = PF1 - PF10
 row 2 (Q - P) = PF11 - PF20
 row 3 (A - F) = PF21 - PF24

Similarly, the PA key assignments have, as their second key, the first three characters on the fourth row of alpha keys (Z, X, C).

4. NK denotes that the indicated key is found in the numeric keypad at the right of the keyboard.

3278 Function	Key Sequence	Hex Value Generated
Reset	CTRL/R	12H
Backspace Cursor	←	08H
Down Cursor	↓	0AH
Up Cursor	↑	0BH
Forward Space Cursor	→	0CH
Home	HOME	1EH
Tab	TAB	09H
Backtab	NK 0	01 49 0DH
Delete	DELETE SYMBOL	7FH
New Line	NK RET. or CTRL/DEL SYMBOL	01 4B 0DH 1FH
Duplicate	NK 6	01 45 0DH
Field Mark	NK ,	01 4C 0DH
Insert Mode	NK .	01 4A 0DH
Erase to End of Field	NK 4	01 43 0DH
Erase Input	NK 7	01 46 0DH
Enter	RETURN	0DH
Clear	NK -	01 4D 0DH
Sys Request	NK 9	01 48 0DH
PF1	ESC 1	1B 31H
PF2	ESC 2	1B 32H
PF3	ESC 3	1B 33H
PF4	ESC 4	1B 34H
PF5	ESC 5	1B 35H
PF6	ESC 6	1B 36H
PF7	ESC 7	1B 37H
PF8	ESC 8	1B 38H
PF9	ESC 9	1B 39H
PF10	ESC 0	1B 30H
PF11	ESC Q or ESC -	1B 51H 1B 2DH
PF12	ESC W or ESC =	1B 57H 1B 3DH
PF13	ESC E	1B 45H
PF14	ESC R	1B 52H
PF15	ESC T	1B 54H
PF16	ESC Y	1B 59H
PF17	ESC U	1B 55H
PF18	ESC I	1B 49H
PF19	ESC O	1B 4FH
PF20	ESC P	1B 50H
PF21	ESC A	1B 41H
PF22	ESC S	1B 53H
PF23	ESC D	1B 44H
PF24	ESC F	1B 46H
PA1	NK 1 or ESC Z	01 40 0DH 1B 5AH
PA2	NK 2 or ESC X	01 41 0DH 1B 58H
PA3 or	NK 3 ESC C	01 42 0DH 1B 43H

A/C-4 (B)

3278 Function	Key Sequence	Hex Value Generated
Print	NK 8	01 47 0DH
Cursor Select	NK 5	01 44 0DH
Attention	ESC \	1B 5CH
Device Cancel	ESC]	1B 5DH
Ident	ESC :	1B 3AH
Test	ESC ;	1B 3BH
Special Function	Key Sequence	Hex Value Generated
Numeric Override	ESC [1B 5BH
Refresh Screen	CTRL/W	17H
Initialize Terminal	ESC <	1B 3CH
Display Status Line	ESC _ (underline)	1B 5FH

G.13 COMPU Terminal Module—Computer-to-Computer Applications

Information on the setup of the micro-, mini-, or instrumentation computer used in the Computer-to-Computer interface will depend on the particular computer being used. Please refer to the manufacturer’s user’s manual and the General Notes on Terminal Switch Settings section of the Introduction to this document for the proper settings, or contact your supplier.

Keyboard Emulation

Following is a table showing how the computer’s keyboard is used in emulation of the 3278 keyboard.

NOTES:

- 1.<Ctrl> is pressed concurrently with the indicated alpha key.
- 2.<Esc> is pressed prior to pressing the indicated alpha key.
- 3.The second character of the ESC sequence PF key assignments is based on the first two-and-one-half rows of alphanumeric keys being treated as a matrix; thus:

row 1 (1 - 0) = PF1 - PF10
 row 2 (Q - P) = PF11 - PF20
 row 3 (A - F) = PF21 - PF24

Similarly, the PA key assignments have, as their second key, the first three characters on the fourth row of alpha keys (Z, X, C). Either lowercase or uppercase (shifted) alpha characters are valid.

3278 Function	Key Sequence	Hex Value Generated
Reset	CTRL/R	12H
Backspace Cursor	CTRL/H	08H
Down Cursor	LINE FEED	0AH
Up Cursor	CTRL/K	0BH
Forward Space Cursor	CTRL/L	0CH
Home	CTRL/^	1EH
Tab	CTRL/T	14H
	or CTRL/I	09H
Back Tab	CTRL/B	02H
Delete	RUB	7FH
	or ESC +	1B 2BH
New Line	CTRL/N	0EH
Duplicate	CTRL/D	04H
Field Mark	CTRL/F	06H
Insert Mode	CTRL/U	15H
Erase to End of Field	CTRL/E	05H
Erase Input	CTRL/X	18H
Enter	RETURN	0DH
Clear	ESC ^	1B 5EH
System Request	ESC ?	1B 3FH
PF1	ESC 1	1B 31H
PF2	ESC 2	1B 32H
PF3	ESC 3	1B 33H
PF4	ESC 4	1B 34H
PF5	ESC 5	1B 35H
PF6	ESC 6	1B 36H
PF7	ESC 7	1B 37H

A/C-4 (B)

3278 Function	Key Sequence	Hex Value Generated
PF8	ESC 8	1B 38H
PF9	ESC 9	1B 39H
PF10	ESC 0	1B 30H
PF11	ESC Q or ESC -	1B 51H 1B 2DH
PF12	ESC W or ESC =	1B 57H 1B 3DH
PF13	ESC E	1B 45H
PF14	ESC R	1B 52H
PF15	ESC T	1B 54H
PF16	ESC Y	1B 59H
PF17	ESC U	1B 55H
PF18	ESC I	1B 49H
PF19	ESC O	1B 4FH
PF20	ESC P	1B 50H
PF21	ESC A	1B 41H
PF22	ESC S	1B 53H
PF23	ESC D	1B 44H
PF24	ESC F	1B 46H
PA1	ESC Z	1B 5AH
PA2	ESC X	1B 58H
PA3	ESC C	1B 43H
Print	CTRL/P	10H
Cursor Select	CTRL/C	03H
Attention	ESC \	1B 5CH
Device Cancel	ESC]	1B 5DH
Ident	ESC :	1B 3AH
Test	ESC ;	1B 3BH
Fast Forwardspace	n. a.	n. a.
Fast Backspace	n. a.	n. a.
Special Function	Key Sequence	Sequence Generated
Numeric Override	ESC [1B 5BH
Refresh Screen	CTRL/W	17H
Initialize Terminal	ESC <	1B 3CH
Display Status Line	ESC _	B 5FH

G.14 D450 Terminal Module—Data General Dasher D400/D450

1. There are 2 sets of DIP switches on the back of the terminal with 8 switches per set. Set these switches as follows.

Left Bank	Set to:	Comments
1	as desired	Reserved
2-4	as desired	Printer Interface and/or Transmit Baud Rate (Split Baud). See Table A below.
5, 6	as desired	Reserved
7, 8	as desired	Split Baud enabled=0, disabled=1
Right Bank	Set to:	Comments
1-4	see below	EIA Port Baud Rate see Table B below.
5, 6	as desired	0, 0 = No parity 0, 1 = Odd parity 1, 0 = Mark parity 1, 1 = Even parity
7	as required	1 = 50 Hz, 0 = 60 Hz
8	n.a.	Reserved

**Table A
Switches**

Baud	2	3	4
4800	1	1	1
2400	1	0	1
1200	0	1	1
300	0	0	1
110	0	0	0

**Table B
Switches**

Baud	1	2	3	4
19200	1	1	1	1
9600	1	1	1	0
4800	1	1	0	0
2400	1	0	1	0
1200	1	0	0	0
300	0	1	1	0
110	0	0	1	1

2. Connect the terminal to the A/C-4 (B) port (modem or direct cable) as appropriate.

Keyboard Emulation

Following is a table showing how the Dasher® D400/D450 keyboard is used in emulation of the 3278 keyboard.

NOTES:

1. Press <Ctrl> concurrently with the indicated key.
2. Press <Esc> prior to pressing the indicated key.

3278 Function	Key Sequence Hex	Value Generated
Reset	CTRL/R 12H	
Backspace Cursor	←	19H
Down Cursor	↓	1AH
Up Cursor	↑	17H
Forward Space Cursor	→	18H
Home	HOME	08H

A/C-4 (B)

3278 Function	Key Sequence	Hex Value Generated
Tab	TAB	09H
Backtab	CTRL/B	02H
Delete	DEL	7FH
New Line	NEW LINE	0AH
Duplicate	CTRL/D	04H
Field Mark	CTRL/F	06H
Insert Mode	CTRL/U	15H
Erase to End of Field	ERASE EOL	0BH
Erase Input	C4	1E 5FH
Enter	CR	0DH
Clear	ERASE PAGE	0CH
Sys Request	ESC ?	1B 3FH
PF1	PF1	1E 71H
PF2	PF2	1E 72H
PF3	PF3	1E 73H
PF4	PF4	1E 74H
PF5	PF5	1E 75H
PF6	PF6	1E 76H
PF7	PF7	1E 77H
PF8	PF8	1E 78H
PF9	PF9	1E 79H
PF10	PF10	1E 7AH
PF11	PF11	1E 7BH
PF12	PF12	1E 7CH
PF13	SHIFT/PF1 or PF13	1E 61H 1E 7DH
PF14	SHIFT/PF2 or PF14	1E 62H 1E 7EH
PF15	SHIFT/PF3 or PF15	1E 63H 1E 70H
PF16	SHIFT/PF4	1E 64H
PF17	SHIFT/PF5	1E 65H
PF18	SHIFT/PF6	1E 66H
PF19	SHIFT/PF7	1E 67H
PF20	SHIFT/PF8	1E 68H
PF21	SHIFT/PF9	1E 69H
PF22	SHIFT/PF10	1E 6AH
PF23	SHIFT/PF11	1E 6BH
PF24	SHIFT/PF12	1E 6CH
PA1	C1	1E 5CH
PA2	C2	1E 5DH
PA3	C3	1E 5EH
Print	CTRL/P	10H
Cursor Select	CTRL/C	03H
Attention	ESC \	1B 5CH
Device Cancel	ESC]	1B 5DH
Ident	ESC :	1B 3AH
Test	ESC ;	1B 3BH

Special Functions	Key Sequence	Hex Value Generated
Numeric Override	ESC [1B 5BH
Refresh Screen	CTRL/A	01H
Initialize Terminal	ESC <	1B 3CH
Display Status Line	ESC _ (underline)	1B 5FH

G.15 DG200 Terminal Module—Data General Dasher D100/200

To set up the Dasher D200 terminal for connection to the A/C-4 (B) in order to emulate the 3278, proceed as follows:

1. Disconnect the AC power cord from the outlet before opening the Dasher D200 case.
2. There are 8 toggle-type switches on the back of the terminal. These switches are used to set the terminal's parity and baud rate.

Baud Rate	Switches			
	1	2	3	4
19200	1	1	1	1
9600	1	1	1	0
4800	1	1	0	0
2400	1	0	1	0
1200	1	0	0	0
300	0	1	1	0
110	0	0	1	1

Parity	Switches	
	5	6
Even	1	1
Mark	1	0
Odd	0	1
None	0	0

NOTE: Switches 7 and 8 are unused.

3. There are 4 switches inside the terminal case which control the printer-interface characteristics. As the A/C-4 (B) does not currently support an auxiliary printer connected to the Dasher D200, the setting of these switches is irrelevant.
4. Replace the cover, reconnect the AC power cord and connect the terminal to the A/C-4 (B) port (or modem, etc.) as appropriate.

Keyboard Emulation

Following is a table showing how the Dasher D200 keyboard is used in emulation of the 3278 keyboard.

NOTES:

1. Press <Ctrl> concurrently with the indicated key.
2. Press <Esc> prior to pressing the indicated key.

3278 Function	Key Sequence	Hex Value Generated
Reset	CTRL/R 12H	
Backspace Cursor	←	19H
Down Cursor	↓	1AH
Up Cursor	↑	17H
Forward Space Cursor	→	18H
Home	HOME	08H Tab TAB 09H
Backtab	CTRL/B	02H

3278 Function	Key Sequence	Hex Value Generated
Delete	DEL	7FH
New Line	NEW LINE	0AH
Duplicate	CTRL/D	04H
Field Mark	CTRL/F	06H
Insert Mode	CTRL/U	15H
Erase to End of Field	ERASE EOL	0BH
Erase Input	C4	1E 5FH
Enter	CR	0DH
Clear	ERASE PAGE	0CH
Sys Request	ESC ?	1B 3FH
PF1	PF1	1E 71H
PF2	PF2	1E 72H
PF3	PF3	1E 73H
PF4	PF4	1E 74H
PF5	PF5	1E 75H
PF6	PF6	1E 76H
PF7	PF7	1E 77H
PF8	PF8	1E 78H
PF9	PF9	1E 79H
PF10	PF10	1E 7AH
PF11	PF11	1E 7BH
PF12	PF12	1E 7CH
PF13	SHIFT/PF1 or PF13	1E 61H 1E 7DH
PF14	SHIFT/PF2 or PF14	1E 62H 1E 7EH
PF15	SHIFT/PF3 or PF15	1E 63H 1E 70H
PF16	SHIFT/PF4	1E 64H
PF17	SHIFT/PF5	1E 65H
PF18	SHIFT/PF6	1E 66H
PF19	SHIFT/PF7	1E 67H
PF20	SHIFT/PF8	1E 68H
PF21	SHIFT/PF9	1E 69H
PF22	SHIFT/PF10	1E 6AH
PF23	SHIFT/PF11	1E 6BH
PF24	SHIFT/PF12	1E 6CH
PA1	C1 1E	5CH
PA2	C2 1E	5DH
PA3	C3 1E	5EH
Print	CTRL/P	10H
Cursor Select	CTRL/C	03H
Attention	ESC \	1B 5CH
Device Cancel	ESC]	1B 5DH
Ident	ESC :	1B 3AH
Test	ESC ;	1B 3BH
Special Functions	Key Sequence	Hex Value Generated
Numeric Override	ESC [1B 5BH
Refresh Screen	CTRL/A	01H
Initialize Terminal	ESC <	1B 3CH
Display Status Line	ESC _ (underline)	1B 5FH

G.16 DISPI Terminal Module—Northern Telecom® Displayphone

To set up the Displayphone® terminal for connection to the A/C-4 (B) in emulation of the 3278, proceed as follows.

The Displayphone does not use DIP switches for options. Instead, options are selected through the keyboard. Perform the following:

Instructions for Dial-Up Connection

1. A telephone jack must be plugged into Line 2 on the back of the Displayphone.
2. Turn terminal on.
3. Press Services key.
4. Select 4 (DISPLAYPHONE UTILITIES)
5. Select 2 (MANUAL DATA CALL PROFILE)

WIDTH	MODE	DUPLEX	PARITY
80	P	F	(set to match A/C-4 (B))
6. Press <Exit> to store data.
7. Press Services again.
8. Press Line 2 and manually dial telephone number.
9. Press Data Soft key for connection.
10. To hang up, press Line 2 and then Release.

NOTES:

1. Use Line 2 for data calls.
2. Maximum baud rate for dial-up is 1200 baud.

Instructions for Direct Connection

1. Connect the RS-232C cable to back of the Displayphone at port marked _ RS-232C.
2. Turn terminal on.
3. Press Services.
4. Select 3 - Local Data Port

Local RS-232 Data Port should be ON			
Set baud rates			
Press Exit			
WIDTH	MODE	DUPLEX	PARITY
80	P	F	(set to match A/C-4 (B))

Press <Exit> to store data.
5. Press Screen key

NOTE:

The maximum baud rate for the Displayphone when directly connected is 9600 baud.

Keyboard Emulation

Following is a table showing how the Displayphone keyboard is used in emulation of the 3278 keyboard.

NOTES:

1. Press <Ctrl> concurrently with the indicated key.
2. Press prior to pressing the indicated key.

3278 Function	Key Sequence	Hex Value Generated
Reset	DEL V or CTRL/R	7F 56H 12H
Backspace Cursor	←	08H
Down Cursor	↓	0AH
Up Cursor	↑	0BH
Forward Space Cursor	→	09H
Home	DEL ^	7F 0BH
Tab	DEL →	7F 09H
Backtab	DEL ←	7F 08H
Delete	DEL B	7F 42H
New Line	DEL lv	7F 0AH
Duplicate	DEL D	7F 44H
Field Mark	DEL F	7F 46H
Insert Mode	DEL N	7F 4EH
Erase to End of Field	DEL M	7F 4DH
Erase Input	DEL K	7F 4BH
Enter	RETURN	0DH
Clear	DEL L	7F 4CH
Sys Request	DEL J	7F 4AH
PF1	DEL 1 or ESC 1	7F 31H 1B 31H
PF2	DEL 2 or ESC 2	7F 32H 1B 32H
PF3	DEL 3 or ESC 3	7F 33H 1B 33H
PF4	DEL 4 or ESC 4	7F 34H 1B 34H
PF5	DEL 5 or ESC 5	7F 35H 1B 35H
PF6	DEL 6 or ESC 6	7F 36H 1B 36H
PF7	DEL 7 or ESC 7	7F 37H 1B 37H
PF8	DEL 8 or ESC 8	7F 38H 1B 38H
PF9	DEL 9 or ESC 9	7F 39H 1B 39H
PF10	DEL 0 or ESC 0	7F 30H 1B 30H

A/C-4 (B)

3278 Function	Key Sequence	Hex Value Generated
PF11	DEL - or ESC -	7F 2DH 1B 2DH
PF12	DEL = or ESC =	7F 3DH 1B 3DH
PF13	DEL Q or ESC Q	7F 51H 1B 51H
PF14	DEL W or ESC W	7F 57H 1B 57H
PF15	DEL E or ESC E	7F 45H 1B 45H
PF16	DEL R or ESC R	7F 52H 1B 52H
PF17	DEL T or ESC T	7F 54H 1B 54H
PF18	DEL Y or ESC Y	7F 59H 1B 59H
PF19	DEL U	7F 55H
PF20	DEL I	7F 49H
PF21	DEL O	7F 4FH
PF22	DEL P	7F 50H
PF23	DEL A	7F 41H
PF24	DEL S	7F 53H
PA1	DEL Z	7F 5AH
PA2	DEL X	7F 58H
PA3	DEL C	7F 43H
Print	CTRL/P	10H
Cursor Select	CTRL/C	03H
Attention	DEL .	7F 2EH
Device Cancel	DEL H	7F 48H
Ident	DEL ,	7F 2CH
Test	DEL /	7F 2FH
Special Function	Key Sequence	Hex Value Generated
Numeric Override	DEL [7F 5BH
Refresh Screen	CTRL/W or DEL G	17H 7F 47H
Initialize Terminal	DEL <	7F 3CH
Display Status Line	DEL _ (underline)	7F 5FH

G.17 DM20 Terminal Module—Beehive DM-20/Standard/Plus

To set up the Beehive® DM-20/STANDARD/PLUS terminals for connection to the A/C-4 (B) in order to emulate the 3278, proceed as follows.

1. Disconnect the AC power cord from the outlet before opening the terminal case.
2. There are three groups of switches on the DM-20/STANDARD/PLUS, with eight switches in each group. Switch groups S1 and S2 are found on the back panel of the terminal; switch group S3 is found on the printed circuit board inside the terminal. There is also a fourth group of switches, located on the printed circuit board, for the PLUS terminal. The settings for the DM-20 will be described first, followed by those for the STANDARD/PLUS terminals. Set the switches to the following values:

DM-20	S1 Value	Comments															
1	as desired	UP enables receiver parity error detection															
2	n. a.	A/C-4 (B) cursor-positioning characteristics make this switch useless															
3	DOWN	Auto Linefeed disabled															
4	DOWN	Keyboard generates lower- and upper-case characters															
5, 6	UP	Termination character CR selected															
7, 8	as desired	<table border="0" style="margin-left: 20px;"> <tr> <td>Parity</td> <td>7</td> <td>8</td> </tr> <tr> <td>MARK</td> <td>UP</td> <td>UP</td> </tr> <tr> <td>SPACE</td> <td>DOWN</td> <td>UP</td> </tr> <tr> <td>ODD</td> <td>UP</td> <td>DOWN</td> </tr> <tr> <td>EVEN</td> <td>DOWN</td> <td>DOWN</td> </tr> </table>	Parity	7	8	MARK	UP	UP	SPACE	DOWN	UP	ODD	UP	DOWN	EVEN	DOWN	DOWN
Parity	7	8															
MARK	UP	UP															
SPACE	DOWN	UP															
ODD	UP	DOWN															
EVEN	DOWN	DOWN															

DM-20	S2 Value	Comments
1, 2, 3	as desired	Main Port Baud Rate
4	UP	Full Duplex selected
5, 6, 7	as desired	Auxiliary Port Baud Rate
8	DOWN	Auto Echo disabled

DM-20 S3	Value	Comments
1	as desired	Go-On-Line switch
2	OFF	Transmit escape codes
3	as required	ON = 50 Hz, OFF = 60 Hz
4	OFF	X-ON/X-OFF enabled
5	unused	
6	OFF	Normal (vs. Reversed) intensity selected
7	as desired	OFF = White characters on black screen, ON = Black characters on white screen
8	OFF	Disable current loop

STANDARD/

A/C-4 (B)

PLUS	S1 Value	Comments
1	n.a.	A/C-4 (B) cursor-positioning characteristics make this switch useless
2	DOWN	Auto Line Feed disabled
3	UP	Full Duplex
4, 5	as desired	Parity 4 5 MARK UP UP SPACE DOWN UP ODD UP DOWN EVEN DOWN DOWN
6, 7, 8	as desired	Main Port Baud Rate
STANDARD/ PLUS	S2 Value	Comments
1, 2	UP	Termination character Cr selected
3, 4, 5	as desired	Aux. port flow control—set to match logical flow control selection configured for printer being used
	Protocol	3 4 5
	DTR (Pin 20)	UP UP UP
	Pins 11 and 19 Ready	DOWN UP UP
	Pins 11 and 19 Busy	UP DOWN UP
	ETX/ACK	DOWN DOWN UP
	XON/XOFF	UP UP DOWN
	ACK/NAK	DOWN UP DOWN
	TTY	UP DOWN DOWN
6, 7, 8	as desired	Aux. Port Baud Rate
STANDARD/ PLUS	S3 Value	Comments
1	OPEN	PLUS: Standard Character Set STANDARD: RS-232C selected
2	as desired	CLOSED: Normal Video OPEN: Reverse Video
3	OPEN	Normal/Half Intensity retains normal (not reversed) denotation
4	as desired	Main Port X-ON/X-OFF CLOSED: enabled Set to match logical flow-control selection configured for the A/C-4 (B) port
5	OPEN	Transmission of keyboard keys enabled
6	as required	OPEN = 60 Hz CLOSED = 50 Hz
7	n.a.	Applicable only in Block Mode
8	OPEN	Character echo from A/C-4 (B) only

PLUS ONLY	S4 Value	Comments
1	as desired	OPEN - Upper case only CLOSED - Upper/lower-case characters generated
2	unused	
3	n.a	Applicable only in Forms mode
4	unused	
5	CLOSED	Main Port RS-232C enabled
6, 7, 8	6 = OPEN 7, 8 = CLOSED	Aux. Port RS-232C enabled

Switches

Baud Rate	1/5/6	2/6/7	3/7/8
110	UP	UP	UP
300	DOWN	UP	UP
1200	UP	DOWN	UP
2400	UP	UP	DOWN
4800	DOWN	UP	DOWN
9600	UP	DOWN	DOWN
19200	DOWN	DOWN	DOWN

3. Replace the cover, reconnect the AC power cord and connect the terminal to the A/C-4 (B) port (or modem, etc.) as appropriate.

DM-D20 Plus Keyboard Emulation

Following is a table showing how the Beehive DM-20/PLUS keyboard is used in emulation of the 3278 keyboard.

NOTES:

1. Press <Ctrl> concurrently with the indicated key.
2. Press <Esc> prior to pressing the indicated key.
3. The last character on the screen (the line 24, column 80 character position) cannot be displayed. This feature is designed to defeat the Beehive Auto-Scroll capability.

3278 Function	Key Sequence	Hex Value Generated
Reset	RESET	1B 56H
Backspace Cursor	←	1B 44H
Down Cursor	↓	1B 42H
Up Cursor	↑	1B 41H
Forward Space Cursor	→	1B 43H
Home	HOME	1B 48H
Tab	TAB	09H
Back Tab	BTAB	1B 3EH
Delete	DCHAR	1B 50H
New Line	LF	0AH
Duplicate	CTRL/D	04H
Field Mark	CTRL/F	06H
Insert Mode	ICHAR	1B 51H
Erase to End of Field	CLEAR EOF	1B 4BH

3278 Function	Key Sequence	Hex Value Generated
Erase Input	DLINE	1B 4DH
Enter	RETURN	0DH
Clear	CTRL/ALL CLEAR	1B 45H
Sys Request	TEST	1B 66H
PF1	F1	02 1B 70 0DH
PF2	F2	02 1B 71 0DH
PF3	F3	02 1B 72 0DH
PF4	F4	02 1B 73 0DH
PF5	F5	02 1B 74 0DH
PF6	F6	02 1B 75 0DH
PF7	F7	02 1B 76 0DH
PF8	F8	02 1B 77 0DH
PF9	F9	02 1B 78 0DH
PF10	F10	02 1B 79 0DH
PF11	F11	02 1B 7A 0DH
PF12	F12	02 1B 7B 0DH
PF13	F13	02 1B 7C 0DH
PF14	F14	02 1B 7D 0DH
PF15	F15	02 1B 7E 0DH
PF16	F16	02 1B 7F 0DH
PF17	ESC 17	1B 31 37H
PF18	ESC 18	1B 31 38H
PF19	ESC 19	1B 31 39H
PF20	ESC 20	1B 32 30H
PF21	ESC 21	1B 32 31H
PF22	ESC 22	1B 32 32H
PF23	ESC 23	1B 32 33H
PF24	ESC 24	1B 32 34H
PA1	ESC @	1B 40H
PA2	ESC -	1B 2DH
PA3	ESC ^	1B 5EH
Print	CTRL/P	10H
Cursor Select	ESC \$	1B 24H
Attention	ESC \	1B 5CH
Device Cancel	ESC]	1B 5DH
Ident	ESC :	1B 3AH
Test	ESC ;	1B 3BH

Special Function	Key Sequence	Hex Value Generated
Numeric Override	ESC [1B 5BH
Refresh Screen	CTRL/W	17H
Initialize Terminal	ESC <	1B 3CH
Display Status Line	ESC _	1B 5FH

Standard Keyboard Emulation

Following is a table showing how the Beehive STANDARD keyboard is used in emulation of the 3278 keyboard.

NOTES:

1. Press <Ctrl> concurrently with the indicated key.
2. Press <Esc> prior to pressing the indicated key.
3. The last character on the screen (the line-24, column-80 character position) cannot be displayed. This feature is designed to defeat the Beehive Auto-Scroll capability.

3278 Function	Key Sequence	Hex Value Generated
Reset	ESC V	1B 56H
Backspace Cursor	←	1B 44H
Down Cursor	↓	1B 42H
Up Cursor	↑	1B 41H
Forward Space Cursor	→	1B 43H
Home	HOME	1B 48H
Tab	CTRL/I	09H
Back Tab	ESC >	1B 3EH
Delete	ESC P	1B 50H
New Line	LF	0AH
Duplicate	CTRL/D	04H
Field Mark	CTRL/F	06H
Insert Mode	ESC Q	1B 51H
Erase to End of Field	ESC K	1B 4BH
Erase Input	ESC M	1B 4DH
Enter	RETURN	0DH
Clear	CTRL/ALL CLEAR	1B 45H
Sys Request	ESC f	1B 66H
PF1	F1	02 1B 70 0DH
PF2	F2	02 1B 71 0DH
PF3	F3	02 1B 72 0DH
PF4	F4	02 1B 73 0DH
PF5	F5	02 1B 74 0DH
PF6	F6	02 1B 75 0DH
PF7	F7	02 1B 76 0DH
PF8	F8	02 1B 77 0DH
PF9	F9	02 1B 78 0DH
PF10	F10	02 1B 79 0DH
PF11	F11	02 1B 7A 0DH
PF12	F12	02 1B 7B 0DH
PF13	CTRL/B, ESC, , CR	02 1B 7C 0DH
PF14	CTRL/B, ESC, }, CR	02 1B 7D 0DH
PF15	CTRL/B, ESC, ~, CR	02 1B 7E 0DH
PF16	CTRL/B, ESC, DEL, CR	02 1B 7F 0DH
PF17	ESC 17	1B 31 37H
PF18	ESC 18	1B 31 38H
PF19	ESC 19	1B 31 39H
PF20	ESC 20	1B 32 30H
PF21	ESC 21	1B 32 31H

A/C-4 (B)

3278 Function	Key Sequence	Hex Value Generated
PF22	ESC 22	1B 32 32H
PF23	ESC 23	1B 32 33H
PF24	ESC 24	1B 32 34H
PA1	ESC @	1B 40H
PA2	ESC -	1B 2DH
PA3	ESC ^	1B 5EH
Print	CTRL/P	10H
Cursor Select	ESC \$	1B 24H
Attention	ESC \	1B 5CH
Device Cancel	ESC]	1B 5DH
Ident	ESC :	1B 3AH
Test	ESC ;	1B 3BH
Special Function	Key Sequence	Hex Value Generated
Numeric Override	ESC [1B 5BH
Refresh Screen	CTRL/W	17H
Initialize Terminal	ESC <	1B 3CH
Display Status Line	ESC _ (underline)	1B 5FH

G.18 DM5 Terminal Module—Beehive DM-1/5/10/30

To set up the Beehive DM-5/Basic terminals for connection to the A/C-4 (B) in order to emulate the 3278, proceed as follows.

1. Disconnect the AC power cord from the outlet before opening the terminal case.
2. There are three groups of switches on the DM-5/BASIC with eight switches in each group. Switch groups S1 and S2 are found on the back panel of the terminal; switch group S3 is found on the printed circuit board inside the terminal. Set the switches to the following values:

S1	Value	Comments																																				
1	n.a.	The A/C-4 (B) cursor-positioning characteristics render this switch unusable																																				
2	DOWN	Auto Line Feed disabled																																				
3	UP	Full Duplex																																				
4, 5	as desired	<table border="0" style="width: 100%;"> <tr> <td style="width: 15%;">Parity</td> <td style="width: 15%;">4</td> <td style="width: 15%;">5</td> <td></td> </tr> <tr> <td>MARK</td> <td>UP</td> <td>UP</td> <td></td> </tr> <tr> <td>SPACE</td> <td>DOWN</td> <td>UP</td> <td></td> </tr> <tr> <td>ODD</td> <td>UP</td> <td>DOWN</td> <td></td> </tr> <tr> <td>EVEN</td> <td>DOWN</td> <td>DOWN</td> <td></td> </tr> </table>	Parity	4	5		MARK	UP	UP		SPACE	DOWN	UP		ODD	UP	DOWN		EVEN	DOWN	DOWN																	
Parity	4	5																																				
MARK	UP	UP																																				
SPACE	DOWN	UP																																				
ODD	UP	DOWN																																				
EVEN	DOWN	DOWN																																				
6, 7, 8	as desired	<table border="0" style="width: 100%;"> <tr> <td colspan="4">Main Port</td> </tr> <tr> <td>Baud Rate</td> <td>6</td> <td>7</td> <td>8</td> </tr> <tr> <td>110</td> <td>UP</td> <td>UP</td> <td>UP</td> </tr> <tr> <td>300</td> <td>DOWN</td> <td>UP</td> <td>UP</td> </tr> <tr> <td>1200</td> <td>UP</td> <td>DOWN</td> <td>UP</td> </tr> <tr> <td>2400</td> <td>UP</td> <td>UP</td> <td>DOWN</td> </tr> <tr> <td>4800</td> <td>DOWN</td> <td>UP</td> <td>DOWN</td> </tr> <tr> <td>9600</td> <td>UP</td> <td>DOWN</td> <td>DOWN</td> </tr> <tr> <td>19200</td> <td>DOWN</td> <td>DOWN</td> <td>DOWN</td> </tr> </table>	Main Port				Baud Rate	6	7	8	110	UP	UP	UP	300	DOWN	UP	UP	1200	UP	DOWN	UP	2400	UP	UP	DOWN	4800	DOWN	UP	DOWN	9600	UP	DOWN	DOWN	19200	DOWN	DOWN	DOWN
Main Port																																						
Baud Rate	6	7	8																																			
110	UP	UP	UP																																			
300	DOWN	UP	UP																																			
1200	UP	DOWN	UP																																			
2400	UP	UP	DOWN																																			
4800	DOWN	UP	DOWN																																			
9600	UP	DOWN	DOWN																																			
19200	DOWN	DOWN	DOWN																																			
S2	Value	Comments																																				
1, 2	UP	Termination character CR selected																																				
3-8	unused																																					
S3	Value	Comments																																				
1	unused																																					
2	as desired	CLOSED: Normal Video OPEN: Reverse Video																																				
3	OPEN	Normal/Half Intensity normal (that is, not reversed) denotation																																				
4	as desired	Main Port X-ON/X-OFF CLOSED: enabled Set to match logical flow-control selection configured for the A/C-4 (B) port																																				
5	OPEN	Transmission of keyboard keys enabled																																				
6	as required	OPEN: 60 Hz CLOSED: 50 Hz																																				
7	n.a.	Applicable only in Block Mode																																				
8	OPEN	Character echo from A/C-4 (B) only																																				

DM-5 Keyboard Emulation

Following is a table showing how the Beehive DM-5 keyboard is used in emulation of the 3278 keyboard.

NOTES:

1. Press <Alt> concurrently with the indicated key.
2. Press <Esc> prior to pressing the indicated key.
3. The last character on the screen (the line-24, column-80 character position) cannot be displayed. This feature is designed to defeat the Beehive Auto-Scroll capability.

3278 Function	Key Sequence	Hex Value Generated
Reset	RESET	1B 56H
Backspace Cursor	← or BACKSPACE	1B 44H 08H
Down Cursor	↓	1B 42H
Up Cursor	↑	1B 41H
Forwardspace Cursor	→	1B 43H
Home	HOME	1B 48H
Tab	→	09H
Backtab	←	1B 3EH
Delete	DELETE CHAR or DEL	1B 50H 7FH
New Line	ALT/J or INSERT LINE	0AH 1B 4CH
Duplicate	ALT/D	04H
Field Mark	ALT/F	06H
Insert Mode	INSERT CHAR	1B 51H
Erase to End of Field	CLEAR EOL	1B 4BH
Erase Input	DELETE LINE or CLEAR EOP	1B 4DH 1B 4AH
Enter	RETURN or ENTER	0DH
Clear	CLEAR	1B 45H
Sys Request	STATUS LINE	1B 54H
PF1	ESC 1	1B 31H
PF2	ESC 2	1B 32H
PF3	ESC 3	1B 33H
PF4	ESC 4	1B 34H
PF5	ESC 5	1B 35H
PF6	ESC 6	1B 36H
PF7	ESC 7	1B 37H
PF8	ESC 8	1B 38H
PF9	ESC 9	1B 39H
PF10	ESC 0	1B 30H
PF11	ESC -	1B 2DH
PF12	ESC =	1B 3DH
PF13	ESC !	1B 21H
PF14	ESC @	1B 40H
PF15	ESC #	1B 23H
PF16	ESC \$	1B 24H
PF17	ESC %	1B 25H
PF18	ESC ^	1B 5EH

3278 Function	Key Sequence	Hex Value Generated
PF19	ESC &	1B 26H
PF20	ESC *	1B 2AH
PF21	ESC (1B 28H
PF22	ESC)	1B 29H
PF23	ESC _ (underline)	1B 5FH
PF24	ESC +	1B 2BH
PA1	ESC ,	1B 2CH
PA2	ESC .	1B 2EH
PA3	ESC /	1B 2FH
Print	PAGE SEND	1B 49H
Cursor Select	ALT/C	03H
Attention	ESC \	1B 5CH
Device Cancel	ESC]	1B 5DH
Ident	ESC :	1B 3AH
Test	ESC ;	1B 3BH

Special Function	Key Sequence	Hex Value Generated
Numeric Override	ESC [1B 5BH
Refresh Screen	ALT/W	17H
Initialize Terminal	ESC <	1B 3CH
Display Status Line	ESC ‘	1B 27H

Basic Keyboard Emulation

Following is a table showing how the Beehive BASIC keyboard is used in emulation of the 3278 keyboard.

NOTES:

1. Press <Ctrl> concurrently with the indicated key.
2. Press <Esc> prior to pressing the indicated key.
3. The last character on the screen (the line-24, column-80 character position) cannot be displayed. This feature is designed to defeat the Beehive Auto-Scroll capability.

3278 Function	Key Sequence	Hex Value Generated
Reset	ESC V	1B 56H
Backspace Cursor	ESC D or BACKSPACE	1B 44H 08H
Down Cursor	ESC B	1B 42H
Up Cursor	ESC A	1B 41H
Forwardspace Cursor	ESC C	1B 43H
Home	ESC H	1B 48H
Tab	CTRL/I	09H
Backtab	ESC >	1B 3EH
Delete	ESC P or DEL	1B 50H 7FH
New Line	LF or ESC L	0AH 1B 4CH
Duplicate	CTRL/D	04H
Field Mark	CTRL/F	06H
Insert Mode	ESC Q	1B 51H

A/C-4 (B)

3278 Function	Key Sequence	Hex Value Generated
Erase to End of Field	ESC K	1B 4BH
Erase Input	ESC M	1B 4DH
	or ESC J	1B 4AH
Enter	RETURN or ENTER	0DH
Clear	CLEAR	1B 45H
Sys Request	ESC T	1B 54H
PF1	ESC 1	1B 31H
PF2	ESC 2	1B 32H
PF3	ESC 3	1B 33H
PF4	ESC 4	1B 34H
PF5	ESC 5	1B 35H
PF6	ESC 6	1B 36H
PF7	ESC 7	1B 37H
PF8	ESC 8	1B 38H
PF9	ESC 9	1B 39H
PF10	ESC 0	1B 30H
PF11	ESC -	1B 2DH
PF12	ESC =	1B 3DH
PF13	ESC !	1B 21H
PF14	ESC @	1B 40H
PF15	ESC #	1B 23H
PF16	ESC \$	1B 24H
PF17	ESC %	1B 25H
PF18	ESC ^	1B 5EH
PF19	ESC &	1B 26H
PF20	ESC *	1B 2AH
PF21	ESC (1B 28H
PF22	ESC)	1B 29H
PF23	ESC _ (underline)	1B 5FH
PF24	ESC +	1B 2BH
PA1	ESC ,	1B 2CH
PA2	ESC . (period)	1B 2EH
PA3	ESC /	1B 2FH
Print	ESC I	1B 49H
Cursor Select	CTRL/C	03H
Attention	ESC \	1B 5CH
Device Cancel	ESC]	1B 5DH
Ident	ESC :	1B 3AH
Test	ESC ;	1B 3BH
Special Function	Key Sequence	Hex Value Generated
Numeric Override	ESC [1B 5BH
Refresh Screen	CTRL/W	17H
Initialize Terminal	ESC <	1B 3CH
Display Status Line	ESC ‘	1B 27H

G.19 DM5AB Terminal Module—Beehive DM-5A/5B

To set up the Beehive DM5A/5B terminals for connection to the A/C-4 (B) in order to emulate the 3278, proceed as follows.

1. Disconnect the AC power cord before opening the terminal case.
2. There are three groups of switches on the DM5A, and four on the DM5B, with eight switches in each group. Switch groups S1 and S2 are found on the back panel of the terminal; switch groups S3 and S4 are found on the printed circuit board inside the terminal. Set the switches to the following values:

S1	Value	Comments																																				
1	n.a.	A/C-4 (B) cursor-positioning characteristics make this switch unusable																																				
2	DOWN	Auto Line Feed disabled																																				
3	UP	Full Duplex																																				
4, 5	as desired	<table border="1"> <thead> <tr> <th>Parity</th> <th>4</th> <th>5</th> </tr> </thead> <tbody> <tr> <td>MARK</td> <td>UP</td> <td>UP</td> </tr> <tr> <td>SPACE</td> <td>DOWN</td> <td>UP</td> </tr> <tr> <td>ODD</td> <td>UP</td> <td>DOWN</td> </tr> <tr> <td>EVEN</td> <td>DOWN</td> <td>DOWN</td> </tr> </tbody> </table>	Parity	4	5	MARK	UP	UP	SPACE	DOWN	UP	ODD	UP	DOWN	EVEN	DOWN	DOWN																					
Parity	4	5																																				
MARK	UP	UP																																				
SPACE	DOWN	UP																																				
ODD	UP	DOWN																																				
EVEN	DOWN	DOWN																																				
6, 7, 8	as desired	<table border="1"> <thead> <tr> <th>Main Port</th> <th>6</th> <th>7</th> <th>8</th> </tr> </thead> <tbody> <tr> <td>Baud Rate</td> <td></td> <td></td> <td></td> </tr> <tr> <td>110</td> <td>UP</td> <td>UP</td> <td>UP</td> </tr> <tr> <td>300</td> <td>DOWN</td> <td>UP</td> <td>UP</td> </tr> <tr> <td>1200</td> <td>UP</td> <td>DOWN</td> <td>UP</td> </tr> <tr> <td>2400</td> <td>UP</td> <td>UP</td> <td>DOWN</td> </tr> <tr> <td>4800</td> <td>DOWN</td> <td>UP</td> <td>DOWN</td> </tr> <tr> <td>9600</td> <td>UP</td> <td>DOWN</td> <td>DOWN</td> </tr> <tr> <td>19200</td> <td>DOWN</td> <td>DOWN</td> <td>DOWN</td> </tr> </tbody> </table>	Main Port	6	7	8	Baud Rate				110	UP	UP	UP	300	DOWN	UP	UP	1200	UP	DOWN	UP	2400	UP	UP	DOWN	4800	DOWN	UP	DOWN	9600	UP	DOWN	DOWN	19200	DOWN	DOWN	DOWN
Main Port	6	7	8																																			
Baud Rate																																						
110	UP	UP	UP																																			
300	DOWN	UP	UP																																			
1200	UP	DOWN	UP																																			
2400	UP	UP	DOWN																																			
4800	DOWN	UP	DOWN																																			
9600	UP	DOWN	DOWN																																			
19200	DOWN	DOWN	DOWN																																			
S2	Value	Comments																																				
1, 2	UP Termination char.	CR selected																																				
3, 4, 5	as desired	Aux. port flow control—set to match logical flow-control selection configured for printer being used																																				
	<table border="1"> <thead> <tr> <th>Protocol</th> <th>3</th> <th>4</th> <th>5</th> </tr> </thead> <tbody> <tr> <td>DTR (Pin 20)</td> <td>UP</td> <td>UP</td> <td>UP</td> </tr> <tr> <td>Pins 11 and 19 Ready</td> <td>DOWN</td> <td>UP</td> <td>UP</td> </tr> <tr> <td>Pins 11 and 19 Busy</td> <td>UP</td> <td>DOWN</td> <td>UP</td> </tr> <tr> <td>ETX/ACK</td> <td>DOWN</td> <td>DOWN</td> <td>UP</td> </tr> <tr> <td>X-ON/X-OFF</td> <td>UP</td> <td>UP</td> <td>DOWN</td> </tr> <tr> <td>ACK/NAK</td> <td>DOWN</td> <td>UP</td> <td>DOWN</td> </tr> <tr> <td>TTY</td> <td>UP</td> <td>DOWN</td> <td>DOWN</td> </tr> </tbody> </table>	Protocol	3	4	5	DTR (Pin 20)	UP	UP	UP	Pins 11 and 19 Ready	DOWN	UP	UP	Pins 11 and 19 Busy	UP	DOWN	UP	ETX/ACK	DOWN	DOWN	UP	X-ON/X-OFF	UP	UP	DOWN	ACK/NAK	DOWN	UP	DOWN	TTY	UP	DOWN	DOWN					
Protocol	3	4	5																																			
DTR (Pin 20)	UP	UP	UP																																			
Pins 11 and 19 Ready	DOWN	UP	UP																																			
Pins 11 and 19 Busy	UP	DOWN	UP																																			
ETX/ACK	DOWN	DOWN	UP																																			
X-ON/X-OFF	UP	UP	DOWN																																			
ACK/NAK	DOWN	UP	DOWN																																			
TTY	UP	DOWN	DOWN																																			
6, 7, 8	as desired	<table border="1"> <thead> <tr> <th>Aux. Port</th> <th>6</th> <th>7</th> <th>8</th> </tr> </thead> <tbody> <tr> <td>Baud Rate</td> <td></td> <td></td> <td></td> </tr> <tr> <td>110</td> <td>UP</td> <td>UP</td> <td>UP</td> </tr> <tr> <td>300</td> <td>DOWN</td> <td>UP</td> <td>UP</td> </tr> <tr> <td>1200</td> <td>UP</td> <td>DOWN</td> <td>UP</td> </tr> <tr> <td>2400</td> <td>UP</td> <td>UP</td> <td>DOWN</td> </tr> <tr> <td>4800</td> <td>DOWN</td> <td>UP</td> <td>DOWN</td> </tr> <tr> <td>9600</td> <td>UP</td> <td>DOWN</td> <td>DOWN</td> </tr> <tr> <td>19200</td> <td>DOWN</td> <td>DOWN</td> <td>DOWN</td> </tr> </tbody> </table>	Aux. Port	6	7	8	Baud Rate				110	UP	UP	UP	300	DOWN	UP	UP	1200	UP	DOWN	UP	2400	UP	UP	DOWN	4800	DOWN	UP	DOWN	9600	UP	DOWN	DOWN	19200	DOWN	DOWN	DOWN
Aux. Port	6	7	8																																			
Baud Rate																																						
110	UP	UP	UP																																			
300	DOWN	UP	UP																																			
1200	UP	DOWN	UP																																			
2400	UP	UP	DOWN																																			
4800	DOWN	UP	DOWN																																			
9600	UP	DOWN	DOWN																																			
19200	DOWN	DOWN	DOWN																																			

A/C-4 (B)

S3	Value	Comments
1	OPEN	DM5B: Standard Character Set DM5A: RS-232C selected
2	as desired	Main Port X-ON/X-OFF CLOSED: enabled Set to match logical flow control selection configured for the A/C-4 (B) port
3	OPEN	Normal/Half Intensity retains normal (not reversed) denotation
4	as desired	Main Port X-ON/X-OFF CLOSED: enabled Set to match logical flow control selection configured for the A/C-4 (B) port
5	OPEN	Transmission of keyboard keys enabled
6	as desired	OPEN = 60 Hz / CLOSED = 50 Hz
7	n.a.	Applicable only in Block mode
8	OPEN	Character echo from A/C-4 (B) only
DM5B ONLY S4	Value	Comments
1	as desired	OPEN: Upper case only CLOSED: Upper/lower-case characters generated
2	unused	
3	n.a.	Applicable only in Forms mode
4	unused	
5	CLOSED	Main Port RS-232C enabled
6, 7, 8	6 = OPEN 7, 8 = CLOSED	Aux. Port RS-232C enabled

3. Replace the cover, reconnect the AC power cord and connect the terminal to the A/C-4 (B) port (or modem, etc.) as appropriate.

Keyboard Emulation

Following is a table showing how the Beehive DM-5A/B keyboard is used in emulation of the 3278 keyboard.

NOTES:

1. Press <Alt> concurrently with the indicated key.
2. Press <Esc> prior to pressing the indicated key.
3. The last character on the screen (the line-24, column-80 character position) cannot be displayed. This feature is designed to defeat the Beehive Auto-Scroll capability.

3278 Function	Key Sequence	Hex Value Generated
Reset	RESET	1B 56H
Backspace Cursor	←	1B 44H
Down Cursor	↓	1B 42H
Up Cursor	↑	1B 41H
Forward Space Cursor	→	1B 43H
Home	HOME	1B 48H
Tab	TAB	09H

3278 Function	Key Sequence	Hex Value Generated
Back Tab	BACKTAB	1B 3EH
Delete	DELETE CHAR	1B 50H
New Line	INSERT LINE	1B 4CH
Duplicate	ALT/D	04H
Field Mark	ALT/F	06H
Insert Mode	INSERT CHAR.	1B 51H
Erase to End of Field	CLEAR EOL	1B 4BH
Erase Input	CLEAR EOP	1B 4AH
Enter	RETURN	0DH
Clear	CLEAR	1B 45H
Sys Request	ESC ?	1B 3FH
PF1	PF1	02 1B 70 0DH
PF2	PF2	02 1B 71 0DH
PF3	PF3	02 1B 72 0DH
PF4	PF4	02 1B 73 0DH
PF5	PF5	02 1B 74 0DH
PF6	PF6	02 1B 75 0DH
PF7	PF7	02 1B 76 0DH
PF8	PF8	02 1B 77 0DH
PF9	PF9	02 1B 78 0DH
PF10	PF10	02 1B 79 0DH
PF11	PF11	02 1B 7A 0DH
PF12	PF12	02 1B 7B 0DH
PF13	PF13	02 1B 7C 0DH
PF14	PF14	02 1B 7D 0DH
PF15	PF15	02 1B 7E 0DH
PF16	PF16	02 1B 7F 0DH
PF17	PF17	1B 37H
PF18	PF18	1B 38H
PF19	PF19	1B 39H
PF20	PF20	1B 30H
PF21	PF21	1B 31H
PF22	PF22	1B 32H
PF23	PF23	1B 33H
PF24	PF24	1B 34H
PA1	ESC ,	1B 2CH
PA2	ESC .	1B 2EH
PA3	ESC /	1B 2FH
Print	PAGE SEND	1B 49H
Cursor Select	ALT/C	03H
Attention	ESC \	1B 5CH
Device Cancel	ESC]	1B 5DH
Ident	ESC :	1B 3AH
Test	ESC ;	1B 3BH
Special Function	Key Sequence	Hex Value Generated
Numeric Override	ESC [1B 5BH
Refresh Screen	CTRL/W	17H
Initialize Terminal	ESC <	1B 3CH
Display Status Line	ESC _ (underline)	1B 5FH

G.20 DM78 Terminal Module—Beehive DM-78

To set up the Beehive DM-78 terminal for connection to the A/C-4 (B) in order to emulate the 3278, proceed as follows.

1. Disconnect the power cord from the outlet before opening the DM-78 case.
2. There are four groups of switches on the DM-78 with eight switches in each group. Switch groups S1 and S2 are found on the back panel of the terminal; switch groups S3 and S4 are found on the printed circuit board inside the terminal. Set the switches to the following values:

S1	Value	Comments
1	unused	
2	DOWN	Auto Linefeed Disabled.
3	unused	
4, 5	as desired	Parity 4 5 MARK UP UP SPACE DOWN UP ODD UP DOWN EVEN DOWN DOWN
6, 7, 8	as desired	Main Port Baud Rate
S2	Value	Comments
1, 2	UP	Termination character CR selected.
3, 4, 5	as desired	Auxiliary Port Protocol—depends on auxiliary device type; see manufacturer's manual for settings.
6, 7, 8	as desired	Auxiliary Port Baud Rate
	Baud Rate	Switches
	110	6 7 8
	300	UP UP UP
	1200	DOWN UP UP
	2400	UP DOWN UP
	4800	UP UP DOWN
	9600	DOWN UP DOWN
	19200	UP DOWN DOWN
		DOWN DOWN DOWN
S3	Value	Comments
1	CLOSED	Current loop disabled
2	CLOSED	Normal video selected
3	unused	
4	as desired	Set to match logical flow control selection configured for the A/C-4 (B) port CLOSED = X-ON/X-OFF (DC1/DC3) enabled OPEN = X-ON/X-OFF disabled for main port
5	unused	
6	as required	CLOSED = 50Hz, OPEN = 60Hz
7, 8	unused	

S4	Value	Comments
1	CLOSED	Keyboard generates lower and upper case characters
2	unuse	
3	OPEN	Data is transmitted out of the auxiliary port, but not processed locally
4	unused	
5	CLOSED	RS-232C communication enabled
6, 7, 8	as required	Auxiliary Port RS-422/RS-232C—depends on the auxiliary device type; see manufacturer's manual for settings

3. Replace the cover, reconnect the AC power cord, and connect the terminal to the A/C-4 (B) port (or modem, etc.) as appropriate.

Keyboard Emulation

Following is a table showing how the Beehive DM-78 keyboard is used in emulation of the 3278 keyboard.

NOTES:

1. Press <Alt> concurrently with the indicated key.
2. Press <Esc> prior to pressing the indicated key.
3. The IBM 3278 keyboard, because it is an EBCDIC terminal, does not provide an ESC key. The DM-78 provides as an ESC key the key immediately below the ATTN key at the left side of the keyboard.

3278 Function	Key Sequence	Hex Value Generated
Reset	ALT/R or RESET	12H 1B 56H
Backspace Cursor	" or ALT/H	1B 44H 08H
Down Cursor	Ø	1B 42H
Up Cursor	≠	1B 41H
Forward Space Cursor	Æ	1B 43H
Home	HOME SYMBOL	1B 48H
Tab	Æ I	09H
Back Tab	I"	1B 3EH
Delete	DELETE SYMBOL	1B 50H
New Line	NEW LINE SYMBOL	0DH
Duplicate	DUP	1B 25H
Field Mark	FIELD MARK	1B 27H
Insert Mode	INSERT SYMBOL	19H
Erase to End of Field	ERASE EOF	1B 4AH
Erase Input	ERASE INPUT	1B 28H
Enter	ENTER	17H
Clear	CLEAR	1B 45H
Sys Request S	YS REQ	1B 2BH
PF1	PF1	1B 70H
PF2	PF2	1B 71H

3278 Function	Key Sequence	Hex Value Generated
PF3	PF3	1B 72H
PF4	PF4	1B 73H
PF5	PF5	1B 74H
PF6	PF6	1B 75H
PF7	PF7	1B 76H
PF8	PF8	1B 77H
PF9	PF9	1B 78H
PF10	PF10	1B 79H
PF11	PF11	1B 7AH
PF12	PF12	1B 7BH
PF13	PF13	1B 7CH
PF14	PF14	1B 7DH
PF15	PF15	1B 7EH
PF16	PF16	1B 7FH
PF17	PF17	1B 67H
PF18	PF18	1B 3DH
PF19	PF19	1B 34H
PF20	PF20	1B 35H
PF21	PF21	1B 36H
PF22	PF22	1B 37H
PF23	PF23	1B 26H
PF24	PF24	1B 30H
PA1	PA1	1B 20H
PA2	PA2	1B 21H
PA3	PA3	1B 22H
Print	ESC 3	1B 33H
Cursor Select	CURSOR SEL	1B 24H
Attention	ESC \	1B 5CH
Device Cancel	DEV CNCL	1B 29H
Ident	IDENT	1B 2FH
Test	TEST	1B 66H
Special Function	Key Sequence	Hex Value Generated
Numeric Override	ESC #	1B 23H
Refresh Screen	ALT/Z	1AH
Initialize Terminal	ESC <	1B 3CH
Display Status Line	ESC _ (underline)	1B 5FH

G.21 HP125 Terminal Module—Hewlett Packard® HP-125

1.To set up the HP-125 type terminal for connection to the A/C-4 (B), it is not necessary to set any external terminal switches. Connect the terminal to the A/C-4 (B) port (modem or direct cable) as appropriate. All terminal straps and HP® function keys either will be set up through remote commands transmitted from the A/C-4 (B) to the terminal, or will be input directly by you through the keyboard into the terminal itself. The following table gives a summary of this initialization procedure.

HP-125 Mode	HP-125 Strap Settings	Comments
TERMINAL MODE	AbCGHI	A/C-4 (B) automatically initializes these strap settings when you initialize the terminal type in response to the User Signon Message response.
	X	Hndsk strap must be set by you to enable X-ON/X-OFF
	E	This strap can be left as is since X-ON/X-OFF and ENQ/ACK do not conflict in normal usage
LOCAL MODE	RETURN straps to	The following sample Normal Settings program on the HP125 can be written to perform this task <pre>10 PRINT CHR\$(27) "&K0a0c1d0j0l0m0n0p0q2R": 20 PRINT CHR\$(27) "&s0a0b0c1g1h0L": 30 END</pre> (Refer to Section 3 of the HP-125 System Reference Manual for the definition of these strap settings)

- 2.It is recommended that the highest valid baud rate (matching for both A/C-4 (B) and the terminal) be selected. If a baud rate of 110 is selected, be sure that the number of stop bits specified is two.
- 3.A/C-4 (B) uses an HP-125 in terminal mode only; it does not allow host system interactions with CP/M programs on the HP-125 or use of HP-125 devices (plotters) other than display and keyboard.
- 4.The protocol conversion tables in A/C-4 (B) cause all display fields in the HP-125 to use HP normal intensity. Therefore, the IBM 3270 screens on the HP-125 type terminal appear slightly different than they appear on genuine IBM 3278-2 terminals, but the differences are minor. Function is not impaired.

Keyboard Emulation

Following is a table showing how the HP-125 terminal type keyboard is used in emulation of the 3278 keyboard.

NOTES:

- 1.Press <Ctrl> concurrently with the indicated key.
- 2.Press <Esc> prior to pressing the indicated key.

A/C-4 (B)

3. The protocol converter has been programmed to take advantage of the HP-125 type intelligent terminal characteristics. For example, the A/C-4 (B) downloads and sets HP-125 type function keys to implement the following IBM functions:

PA1ERASE INPUT
PA2ERASE EOF
PA3INSERT
CLEAR DELETE

3278 Function	Key Sequence	Hex Value Generated
Reset	CTRL/R	12H
Backspace Cursor	"	1B 44H
	or BACKSPACE	08H
Down Cursor	Ø	1B 42H
Up Cursor	≠	1B 41H
Forward Space Cursor	Æ	1B 43H
Home	HOME	1B 48H
Tab	TAB	09H
Back Tab	SHIFT TAB	1B 49H
Delete	F8	1B 50H
	or DEL	7FH
New Line	ESC F	1B 46H
	or CTRL/N	0EH
Duplicate	CTRL/D	04H
Field Mark	CTRL/F	06H
Insert Mode	F7	1B 51H
Erase to end of field	F6	1B 4BH
Erase Input	F5	1B 4DH
Enter	RETURN	0DH
Clear	F4	1B 4AH
System Request	ESC ?	1B 3FH
PF1	ESC 1	1B 31H
PF2	ESC 2	1B 32H
PF3	ESC 3	1B 33H
PF4	ESC 4	1B 34H
PF5	ESC 5	1B 35H
PF6	ESC 6	1B 36H
PF7	ESC 7	1B 37H
PF8	ESC 8	1B 38H
PF9	ESC 9	1B 39H
PF10	ESC 0	1B 30H
PF11	ESC -	1B 2DH
PF12	ESC =	1B 3DH
PF13	ESC !	1B 21H
PF14	ESC @	1B 40H
PF15	ESC #	1B 23H
PF16	ESC \$	1B 24H
PF17	ESC %	1B 25H
PF18	ESC ^	1B 5EH
PF19	ESC &	1B 26H
PF20	ESC *	1B 2AH
PF21	ESC (1B 28H

3278 Function	Key Sequence	Hex Value Generated
PF22	ESC)	1B 29H
PF23	ESC _ (underline)	1B 5FH
PF24	ESC +	1B 2BH
PA1	F1	1B 2CH
PA2	F2	1B 2EH
PA3	F3	1B 2FH
Print	CTRL/P	10H
Cursor Select	CTRL/C	03H
Attention	ESC \	1B 5CD
Device Cancel	ESC]	1B 5DH
Ident	ESC :	1B 3AH
Test	ESC ;	1B 3BH
Special Function	Key Sequence	Hex Value Generated
Numeric Override	ESC [1B 5BH
Refresh Screen	CTRL/W	17H
Initialize Terminal	ESC <	1B 3CH
Display Status Line	CTRL/V	16H

G.22 HP21 Terminal Module—Hewlett Packard HP-2621B/2641

To set up the HP-2621B terminal for connection to A/C-4 (B) in order to emulate the 3278, proceed as follows:

1. Disconnect the AC power cord from the outlet before setting up the configuration switches.
2. There are eight toggle-type switches on the terminals RIGHT-HAND Group of switches on the rear panel. These switches are used to specify the physical strapping configuration of the HP-2621B terminal. Set these switches in the following manner:

Right-hand Switches	Set to:	Comments
R0 (RET/ENT KEY STRING)	R0=DOWN	Transmit CR when Return or
R1	R1=DOWN	Enter key pressed
X (DATA SPEED SEL)	DOWN	X:- Data Speed Select option strap disabled
H (LONG TRANS)	UP	H: Long Transfer Warning Handshake strap disabled
G (SHORT TRANS)	UP	G: Short Transfer Trigger Handshake strap disabled
C (WRAP, EOL)	UP	C: Wraparound, EOL strap disabled
A (ESC SEQ)	UP	A: Escape Sequence Transmission enabled

3. There are eight toggle-type switches on the terminals CENTER Group of switches on the rear panel. These switches are used to specify terminal operating characteristics. Set these switches in the following manner:

Center Switches	Set to:	Comments
P0, P1 and P2	P0=DOWN P1=DOWN P2=DOWN	(Sets no parity—8th bit always 1)
	P0=UP P1=DOWN P2=DOWN	(Sets no parity—8th bit always 0)
	P0=DOWN P1=DOWN P2=UP	(Sets EVEN parity in 8th bit)
	P0=UP P1=DOWN P2=UP	(Sets ODD parity in 8th bit)
	P0=DOWN P1=UP P2=DOWN	(Sets no parity—data full 8 bits)
X (XON/XOFF)	as desired	Set to match logical flow control selection configured at the A/C-4 (B) port
NOTE: The fifth switch is not used.		
E (ENQ/ACK)	DOWN	ENQ/ACK handshake disabled
LF (AUTO LF)	DOWN	Auto LF disabled
LM (LINE CHAR MODE)	DOWN	Selects character mode

4. There are eight toggle-type switches on the terminal's left-hand group of switches on the rear panel. These switches are used to specify terminal operating characteristics. Set these switches in the following manner:

Left-hand Switches	Set to:	Comments		
B0 (BAUD RATE)	110 bps	B0=DOWN	B1=DOWN	B2=DOWN
B1	300 bps	B0=DOWN	B1=UP	B2=DOWN
B2	1200 bps	B0=DOWN	B1=DOWN	B2=UP
	2400 bps	B0=UP	B1=DOWN	B2=UP
	4800 bps	B0=DOWN	B1=UP	B2=UP
	9600 bps	B0=UP	B1=UP	B2=UP
EC (ECHO)	DOWN	Set ECHO to remote		
IV (INVERSE VIDEO/ UNDERLINE)	UP	Set Inverse Video as the default		
L0	DOWN	Set English as national language configuration		
L1	UP			
L2	UP			

5.Reconnect the AC power cord and connect the terminal to the A/C-4 (B) port (direct connect or modem) as appropriate.

Keyboard Emulation

Following is a table showing how the HP-2621B keyboard is used in emulation of the 3278 keyboard.

NOTES:

- 1.Press <Ctrl> concurrently with the indicated key.
- 2.Press <Esc> prior to pressing the indicated key.
- 3.The A/C-4 (B) has been programmed to take advantage of the HP-125 type intelligent terminal characteristics. For example, the A/C-4 (B) downloads and sets HP-125 type function keys to implement the following IBM functions:

```
PA1      ERASE INPUT
PA2ERASE EOF
PA3INSERT
CLEAR    DELETE
```

3278 Function	Key Sequence	Hex Value Generated
Reset	CTRL/R	12H
Backspace Cursor	←	1B 44H
	or BACKSPACE	08H
Down Cursor	↓	1B 42H
Up Cursor	↑	1B 41H
Forward Space Cursor	→	1B 43H
Home	HOME	1B 48H
Tab	TAB	09H
Back Tab	SHIFT TAB	1B 49H
Delete	F8	1B 50H
	or DEL	7FH
New Line	ESC F	1B 46H
	or CTRL/N	0EH
Duplicate	CTRL/D	04H

A/C-4 (B)

3278 Function	Key Sequence	Hex Value Generated
Field Mark	CTRL/F	06H
Insert Mode	F7	1B 51H
Erase to end of field	F6	1B 4BH
Erase Input	F5	1B 4DH
Enter	RETURN	0DH
Clear	F4	1B 4AH
System Request	ESC ?	1B 3FH
PF1	ESC 1	1B 31H
PF2	ESC 2	1B 32H
PF3	ESC 3	1B 33H
PF4	ESC 4	1B 34H
PF5	ESC 5	1B 35H
PF6	ESC 6	1B 36H
PF7	ESC 7	1B 37H
PF8	ESC 8	1B 38H
PF9	ESC 9	1B 39H
PF10	ESC 0	1B 30H
PF11	ESC -	1B 5FH
PF12	ESC =	1B 3DH
PF13	ESC !	1B 21H
PF14	ESC @	1B 40H
PF15	ESC #	1B 23H
PF16	ESC \$	1B 24H
PF17	ESC %	1B 25H
PF18	ESC ^	1B 5EH
PF19	ESC &	1B 26H
PF20	ESC *	1B 2AH
PF21	ESC (1B 28H
PF22	ESC)	1B 29H
PF23	ESC _ (underline)	1B 1FH
PF24	ESC +	1B 2BH
PA1	F1	1B 2CH
PA2	F2	1B 2EH
PA3	F3	1B 2FH
Print	CTRL/P	10H
Cursor Select	CTRL/C	03H
Attention	ESC \	1B 5CH
Device Cancel	ESC]	1B 5DH
Ident	ESC :	1B 3AH
Test	ESC ;	1B 3BH
Special Function	Key Sequence	Hex Value Generated
Numeric Override	ESC [1B 5BH
Refresh Screen	CTRL/W	17H
Initialize Terminal	ESC <	1B 3CH
Display Status Line	ESC L	1B 4CH

G.23 HP45 Terminal Module—Hewlett Packard HP-2621A/P/2645

To set up the HP-2645 terminal for connection to the A/C-4 (B) in order to emulate the 3278, proceed as follows:

1. Disconnect the AC power cord from the outlet before setting up the configuration switches.
2. There are three switches located at the upper left of the keyboard. These control the duplex, parity and baud rate data communication options. Set the Duplex switch to FULL, and set the parity and baud as desired.
3. There are three groups of switches, with eight switches in each group, found on the 13260A Standard Asynchronous Communications PCA board within the terminal. Set these switches to the following values.

Switch	Set to:	Comments
A	OPEN	Transmit ESCAPE codes
B	CLOSED	Typed spaces will overwrite existing characters
C	OPEN	Auto wraparound disabled
D	n. a.	Applicable only in Block Mode
E	n.a	Applicable only with paper tape reading
F	CLOSED	Terminal Baud is determined by the switch on the keyboard
G, H, J, K	n. a.	Applicable only in Block Mode
L	CLOSED	No effect on Self-Test
M	CLOSED	INSERT CHAR and DELETE CHAR keys operate in normal sense
N	CLOSED	No effect on printer ESCAPE code transfer
P, Q	as desired	APL printing pairing codes
R	OPEN	Transition from receive state to transmit occurs after CB (Clear to Send) goes on
S, T	CLOSED	Non-main channel protocol
U, V	OPEN	Terminal ignores all transitions of SB (Secondary Receive Data) and CF (Carrier Detect)
W	as desired	Disable/Enable Data Comm. Self Test
X	as desired	Data Speed signal low or high (CH=0 or 1)
Y	as desired	Transmit LED lit for CB (Send to Clear) or for CC (Data Set Ready)
Z	as desired	If Parity switch is set to No Parity, this switch forces bit 8 to zero (CLOSED) or one (OPEN). If Parity switch is set to Even or Odd, this switch chooses Check for parity error (CLOSED) or No check for parity error (OPEN).

4. Replace the terminal cover, reconnect the AC power cord and connect the terminal to the A/C-4 (B) port (modem, etc.) as appropriate.

Keyboard Emulation

Following is a table showing how the HP-2645 keyboard is used in emulation of the 3278 keyboard.

NOTES:

1. Press <Ctrl> concurrently with the indicated key.
2. Press <Esc> prior to pressing the indicated key.

3278 Function	Key Sequence	Hex Value Generated
Reset	CTRL/R	12H
Backspace Cursor	← or BACKSPACE	1B 44H 08H
Down Cursor	↓	1B 42H
Up Cursor	↑	1B 41H
Forward Space Cursor	→	1B 43H
Home	HOME	1B 68H
Tab	TAB	09H
Back Tab	CTRL/TAB or CTRL/BACKSPACE	1B 69H
Delete	DELETE CHAR or DELETE	1B 50H 7FH
New Line	NEW LINE	0EH
Duplicate	CTRL/D	04H
Field Mark	CTRL/F	06H
Insert Mode	INSERT CHAR or INSERT LINE	1B 51H 1B 4CH
Erase to end of field	DELETE LINE or CTRL/E	1B 4DH 05H
Erase Input	CTRL/X	18H
Enter	RETURN	0DH
Clear	CLEAR DISPLAY	1B 4AH
System Request	ESC ?	1B 3FH
PF1	PF 1	1B 70H
PF2	PF 2	1B 71H
PF3	PF 3	1B 72H
PF4	PF 4	1B 73H
PF5	PF 5	1B 74H
PF6	PF 6	1B 75H
PF7	PF 7	1B 76H
PF8	PF 8	1B 77H
PF9	ESC 09	1B 30 39H
PF10	ESC 10	1B 31 30H
PF11	ESC 11	1B 31 31H
PF12	ESC 12	1B 31 32H
PF13	ESC 13	1B 31 33H
PF14	ESC 14	1B 31 34H
PF15	ESC 15	1B 31 35H
PF16	ESC 16	1B 31 36H
PF18	ESC 18	1B 31 38H
PF19	ESC 19	1B 31 39H
PF20	ESC 20	1B 32 30H
PF21	ESC 21	1B 32 31H

3278 Function	Key Sequence	Hex Value Generated
PF22	ESC 22	1B 32 32H
PF23	ESC 23	1B 32 33H
PF24	ESC 24	1B 32 34H
PA1	ESC ,	1B 2CH
PA2	ESC .	1B 2EH
PA3	ESC /	1B 2FH
Print	CTRL/P	10H
Cursor Select C	TRL/C	03H
Attention	ESC \	1B 5CH
Device Cancel	ESC]	1B 5DH
Ident	ESC :	1B 3AH
Test	ESC ;	1B 3BH
Special Function	Key Sequence	Hex Value Generated
Numeric Override	ESC [1B 5BH
Refresh Screen	CTRL/W	17H
Initialize Terminal	ESC <	1B 3CH
Display Status Line	ESC _	1B 5FH

G.24 HZ14 Terminal Module—Hazeltine 1400/1420

To set up the Hazeltine® 1400 terminal for connection to A/C-4 (B) in order to emulate the 3278, proceed as follows:

1. Disconnect the AC power cord from the outlet before setting the switches.
2. There are 8 control switches located under the terminal's Access Plate. These switches are used to specify terminal operating characteristics. Lift (or remove) the Access Plate to set the switches. The switches are numbered 1 through 8 (from the left) and should be set as follows:

Switch	Set to:	Comments
1, 2	DOWN	Not applicable
3, 4	As appropriate	Set to match parity of the A/C-4 (B) port for the terminal as described above
5	DOWN	Specifies full-duplex mode

3. The remaining control switches are used to set the baud rate for communication with A/C-4 (B). The baud rate specified here must match the baud rate specified for the port to which this terminal is to be connected. It is recommended that the highest valid baud rate (matching for both A/C-4 (B) and the terminal) be selected. If a baud rate of 110 is selected, be sure the number of Stop bits specified is 2.

Set the baud rate, as follows:

Baud Rate	Switches		
	6	7	8
110	UP	UP	UP
300	DOWN	UP	UP
600	UP	DOWN	UP
1200	DOWN	DOWN	UP
1800	UP	UP	DOWN
2400	DOWN	UP	DOWN
4800	UP	DOWN	DOWN
9600	DOWN	DOWN	DOWN

4. Replace the Access Plate, reconnect the AC power cord and connect the terminal to the A/C-4 (B) port (or modem, etc.), as appropriate.

Keyboard Emulation

Following is a table showing how the Hazeltine 1400 keyboard is used in emulation of the 3278 keyboard.

NOTES:

1. Press <Ctrl> concurrently with the indicated key.
2. Press <Esc> prior to pressing the indicated key.
3. The second character of the ESC sequence PF key assignments is based on the first two-and-one-half rows of alphanumeric keys being treated as a matrix; thus:

row 1 (1 - 0) = PF1 - PF10
 row 2 (Q - P) = PF11 - PF20
 row 3 (A - F) = PF21 - PF24

Similarly, the PA key assignments have, as their second key, the first three characters on the fourth row of alpha keys (Z, X, C). Either lower-case or upper-case (shifted) alpha characters are valid.

4. The last character on the screen (the line-24, column-80 character position) cannot be displayed. This feature is designed to defeat the Hazeltine Auto-Scroll capability.
5. No Assistance (Help) Menu is available.

3278 Function	Key Sequence	Hex Value Generated
Reset	CTRL/R	12H
Backspace Cursor	CTRL/H	08H
Down Cursor	CTRL/J or LINEFEED	0AH
Up Cursor	CTRL/K	0BH
Forward Space Cursor	CTRL/L	0CH
Home	ESC CTRL/R	1B 12H
Tab	CTRL/I	09H
Back Tab	CTRL/B	02H
Delete	RUB	7FH
	or ESC +	1B 2BH
New Line	CTRL/N	0EH
Duplicate	CTRL/D	04H
Field Mark	CTRL/F	06H
Insert Mode	CTRL/U	15H
Erase to End of Field	CTRL/E	05H
Erase Input	CTRL/X	18H
Enter	RETURN	0DH
Clear	ESC CTRL/\	1B 1CH
Sys Request	ESC ?	1B 3FH
PF1	ESC 1	1B 31H
PF2	ESC 2	1B 32H
PF3	ESC 3	1B 33H
PF4	ESC 4	1B 34H
PF5	ESC 5	1B 35H
PF6	ESC 6	1B 36H
PF7	ESC 7	1B 37H
PF8	ESC 8	1B 38H
PF9	ESC 9	1B 39H
PF10	ESC 0	1B 30H
PF11	ESC Q	1B 51H
	or ESC -	1B 2DH
PF12	ESC W	1B 57H
	or ESC =	1B 3DH
PF13	ESC E	1B 45H
PF14	ESC R	1B 52H
PF15	ESC T	1B 54H
PF16	ESC Y	1B 59H
PF17	ESC U	1B 55H
PF18	ESC I	1B 49H
PF19	ESC O	1B 4FH
PF20	ESC P	1B 50H
PF21	ESC A	1B 41H
PF22	ESC S	1B 53H
PF23	ESC D	1B 44H

A/C-4 (B)

3278 Function	Key Sequence	Hex Value Generated
PF24	ESC F	1B 46H
PA1	ESC Z	1B 5AH
PA2	ESC X	1B 58H
PA3	ESC C	1B 43H
Print	CTRL/P	10H
Cursor Select	CTRL/C	03H
Attention	ESC \	1B 5CH
Device Cancel	ESC]	1B 5DH
Ident	ESC :	1B 3AH
Test	ESC ;	1B 3BH
Special Function	Key Sequence	Hex Value Generated
Numeric Override	ESC [1B 5BH
Refresh Screen	CTRL/W	17H
Initialize Terminal	ESC <	1B 3CH
Display Status Line	ESC _ (underline)	1B 5FH

G.25 HZ150 Terminal Module—Hazeltine 1500

To set up the Hazeltine 1500 terminal for connection to the A/C-4 (B) in order to emulate the 3278, proceed as follows:

1. Disconnect the AC power cord from the outlet before setting the switches.
2. There are 24 switches located under the terminal’s access plate above the keyboard. They are made up of 3 DIP switch groups, each with 8 individual switches.

Set the right-most group of switches as follows

Switch # (left to right)	Set to:	Comments
1, 2	DOWN	RS-232C
3 - 8	not used	

Set the middle group of switches as follows:

Switch # (right to left)	Set to:	Comments
1	STD VIDEO	Standard video
2	U/L case	Upper and lower case characters
3	CR	No Auto Linefeed
4	FULL	Full duplex

For switches 5-8, set one switch down (toward the keyboard) for the desired parity and all three others up (away from the keyboard).

5	parity = 0
6	1
7	ODD
8	EVEN

3. The 8 leftmost switches are used to set the baud rate. To set a particular baud rate, set the proper switch down (toward the keyboard) and all 7 others up (away from it).

Switch # (right to left)	Baud Rate
1	19,200
2	9,600
3	4,800
4	2,400
5	1,800 (not supported by A/C-4 (B))
6	1,200
7	300
8	110

4. Replace the access plate, reconnect the AC power cord, and connect the terminal to the A/C-4 (B) port (or modem) as appropriate.

Keyboard Emulation

Following is a table showing how the Hazeltine 1500 keyboard is used in emulation of the 3278 keyboard.

NOTES:

1. Press <Ctrl> concurrently with the indicated key.
2. Press <Esc> prior to pressing the indicated key.
3. The second character of the ESC sequence PF key assignments is based on the first two-and-one-half rows of alphanumeric keys being treated as a matrix, thus:

row 1 (1 - 0) = PF1 - PF10
 row 2 (Q - P) = PF11 - PF20
 row 3 (A - F) = PF21 - PF24

Similarly, the PA key assignments have, as their second key, the first three characters on the fourth row of alpha keys (Z, X, C). Either lower-case or upper-case (shifted) alpha characters are valid.

4. The last character on the screen (the line-24, column-80 character position) cannot be displayed. This feature is designed to defeat the Hazeltine 1500 Auto-Scroll capability.

3278 Function	Key Sequence	Hex Value Generated
Reset	CTRL/R	12H
Backspace Cursor	BACKSPACE	08H
Down Cursor	CTRL/J or LINEFEED	0AH
Up Cursor	CTRL/K	0BH
Forward Space Cursor	CTRL/L	0CH
Home	CTRL/^	1EH
Tab	CTRL/T	14H
Back Tab	or CTRL/I	09H
Delete	CTRL/B	02H
	DEL	7FH
	or ESC +	1B 2BH
New Line	CTRL/N	0EH
Duplicate	CTRL/D	04H
Field Mark	CTRL/F	06H
Insert Mode	CTRL/U	15H
Erase to End of Field	CTRL/E	05H
Erase Input	CTRL/X	18H
Enter	RETURN	0DH
Clear	ESC ^	1B 5EH
Sys Request	ESC ?	1B 3FH
PF1	ESC 1	1B 31H
PF2	ESC 2	1B 32H
PF3	ESC 3	1B 33H
PF4	ESC 4	1B 34H
PF5	ESC 5	1B 35H
PF6	ESC 6	1B 36H
PF7	ESC 7	1B 37H
PF8	ESC 8	1B 38H
PF9	ESC 9	1B 39H
PF10	ESC 0	1B 30H

3278 Function	Key Sequence	Hex Value Generated
PF11	ESC Q 1B or ESC -	51H 1B 2DH
PF12	ESC W or ESC =	1B 57H 1B 3DH
PF13	ESC E	1B 45H
PF14	ESC R	1B 52H
PF15	ESC T	1B 54H
PF16	ESC Y	1B 59H
PF17	ESC U	1B 55H
PF18	ESC I	1B 49H
PF19	ESC O	1B 4FH
PF20	ESC P	1B 50H
PF21	ESC A	1B 41H
PF22	ESC S	1B 53H
PF23	ESC D	1B 44H
PF24	ESC F	1B 46H
PA1	ESC Z	1B 5AH
PA2	ESC X	1B 58H
PA3	ESC C	1B 43H
Print	CTRL/P	10H
Cursor Select	CTRL/C	03H
Attention	ESC \	1B 5CH
Device Cancel	ESC]	1B 5DH
Ident	ESC :	1B 3AH
Test	ESC ;	1B 3BH
Special Function	Key Sequence	Hex Value Generated
Numeric Override	ESC [1B 5BH
Refresh Screen	CTRL/W	17H
Initialize Terminal	ESC <	1B 3CH
Display Status Line	ESC _ (underline)	1B 5FH

G.26 HZ151 Terminal Module—Hazeltine 1510/1520

To set up the Hazeltine 1510 terminal for connection to the A/C-4 (B) in order to emulate the 3278, proceed as follows:

1. Disconnect the AC power cord from the outlet before setting the switches.
2. There are 24 switches located under the terminal's access plate above the keyboard. They are made up of 3 DIP switch groups, each with 8 individual switches.

Set the rightmost group of switches as follows:

Switch # (left to right)	Set to:	Comments
1, 2	UP	RS-232C
3	-	N/A
4	DOWN	ESC as lead-in
5	UP	Sets character mode
6, 7	DOWN	Sets EOM to CR
8	DOWN	No wrap on column 80

Set the middle group of switches as follows:

Switch # (right to left)	Set to:	Comments
1	STD VIDEO	Standard video
2	U/Lcase	Upper- and lower-case characters
3	CR	No Auto Linefeed
4	FULL	Full duplex

For switches 5-8, set one switch down (toward the keyboard) for the desired parity and all three others up (away from the keyboard).

5	parity = 0
6	1
7	ODD
8	EVEN

3. The 8 left most switches are used to set the baud rate. To set a particular baud rate, set the proper switch down (toward the keyboard) and all 7 others up (away from it).

Switch # (right to left)	Baud Rate
1	19,200
2	9,600
3	4,800
4	2,400
5	1,800 (not supported by A/C-4 (B))
6	1,200
7	300
8	110

4. Replace the access plate, reconnect the AC power cord, and connect the terminal to the A/C-4 (B) port (or modem).

Keyboard Emulation

Following is a table showing how the Hazeltine 1510 keyboard is used in emulation of the 3278 keyboard.

NOTES:

1. Press <Ctrl> concurrently with the indicated key.
2. Press <Esc> prior to pressing the indicated key.
3. The second character of the ESC sequence PF key assignments is based on the first two-and-one-half rows of alphanumeric keys being treated as a matrix, thus:

row 1 (1 - 0) = PF1 - PF10
 row 2 (Q - P) = PF11 - PF20
 row 3 (A - F) = PF21 - PF24

Similarly, the PA key assignments have, as their second key, the first three characters on the fourth row of alpha keys (Z, X, C). Either lower-case or upper-case (shifted) alpha characters are valid.

4. The last character on the screen (the line-24, column-80 character position) cannot be displayed. This feature is designed to defeat the Hazeltine 1510 Auto-Scroll capability.

3278 Function	Key Sequence	Hex Value Generated
Reset	CTRL/R	12H
Backspace Cursor	BACKSPACE	08H
Down Cursor	CTRL/J or LINEFEED	0AH
Up Cursor	CTRL/K	0BH
Forward Space Cursor	CTRL/L	0CH
Home	HOME	1B 12H
Tab	TAB	09H
Back Tab	CTRL/B	02H
Delete	DEL	7FH
New Line	CTRL/N	0EH
Duplicate	CTRL/D	04H
Field Mark	CTRL/F	06H
Insert Mode	CTRL/U	15H
Erase to End of Field	CTRL/E	05H
Erase Input	CTRL/X	18H
Enter	RETURN	0DH
Clear	CLEAR	1B 1CH
Sys Request	ESC ?	1B 3FH
PF1	ESC 1	1B 31H
PF2	ESC 2	1B 32H
PF3	ESC 3	1B 33H
PF4	ESC 4	1B 34H
PF5	ESC 5	1B 35H
PF6	ESC 6	1B 36H
PF7	ESC 7	1B 37H
PF8	ESC 8	1B 38H
PF9	ESC 9	1B 39H
PF10	ESC 0	1B 30H
PF11	ESC Q	1B 51H
PF12	ESC W	1B 57H
PF13	ESC E	1B 45H

A/C-4 (B)

3278 Function	Key Sequence	Hex Value Generated
PF14	ESC R	1B 52H
PF15	ESC T	1B 54H
PF16	ESC Y	1B 59H
PF17	ESC U	1B 55H
PF18	ESC I	1B 49H
PF19	ESC O	1B 4FH
PF20	ESC P	1B 50H
PF21	ESC A	1B 41H
PF22	ESC S	1B 53H
PF23	ESC D	1B 44H
PF24	ESC F	1B 46H
PA1	ESC Z	1B 5AH
PA2	ESC X	1B 58H
PA3	ESC C	1B 43H
Print	CTRL/P	10H
Cursor Select	CTRL/C	03H
Attention	ESC \	1B 5CH
Device Cancel	ESC]	1B 5DH
Ident	ESC :	1B 3AH
Test	ESC ;	1B 3BH
Special Function	Key Sequence	Hex Value Generated
Numeric Override	ESC [1B 5BH
Refresh Screen	CTRL/W	17H
Initialize Terminal	ESC <	1B 3CH
Display Status Line	ESC _ (underline)	1B 5FH

G.27 HZ78 Terminal Module—Hazeltine Esprit 10-78

To set up the Hazeltine 10-78 terminal for connection to the A/C-4 (B) in order to emulate the 3278, proceed as follows.

All operator-selectable options are input from the keyboard into the Setup Mode Status Line; there are no external switches.

1. Connect the terminal to the A/C-4 (B) port (modem or direct cable) as appropriate.
2. Call up the Status Line by pressing <Alt> and <Esc> simultaneously. Set the option values as follows:

Option	Value/Comments
0	3278 Keyboard
1	PF option on Alternate Keypad
2	ESC as lead-in character
3	Full Duplex
4	Character-oriented attributes
5	NO/Disable Auto Scroll
6	NO/Disable Auto New Line
7	?/Diagnostic Test
8	?/Cursor Block or Underline
9	?/50 Hz or 60 Hz.
A	?/Main Port Baud Rate
B	?/Auxiliary Port Baud Rate
C	?/Main Parity: EVEN, ODD, MARK, SPACE
D	?/Auxiliary Parity: EVEN, ODD, MARK, SPACE
?	Set as desired or as required by other factors (A/C-4 (B) configuration, etc.).

Keyboard Emulation

Following is a table showing how the Hazeltine 10-78 keyboard is used in emulation of the 3278 keyboard.

NOTES:

1. Press <Alt> concurrently with the indicated key.
2. Press <Esc> prior to pressing the indicated key.
3. The IBM 3278 keyboard, because it is an EBCDIC terminal, does not provide an ESC key. The Hazeltine 10-78 provides an ESC key immediately below the ATTN key at the left side of the keyboard.

3278 Function	Key Sequence	Hex Value Generated
Reset	RESET 1B 01H	
Backspace Cursor	←	08H
Down Cursor	↓	1B 0BH
Up Cursor	↑	1B 0CH
Forward Space Cursor	→	10H
Home	HOME	1B 12H
Tab	TAB	09H
Backtab	BACKTAB	0FH
Delete	DEL	7FH
New Line	NEW LINE	0AH

A/C-4 (B)

3278 Function	Key Sequence	Hex Value Generated
Duplicate	DUP	0EH
Field Mark	FIELD MARK	17H
Insert Mode	INSERT	19H
Erase to End of Field	ERASE EOF	18H
Erase Input	ERASE INPUT	12H
Enter	ENTER	0DH
Clear	CLEAR	1B 4DH
Sys Request	SYS REQ	1B 3BH
PF1	PF1	1B 31H
PF2	PF2	1B 32H
PF3	PF3	1B 33H
PF4	PF4	1B 34H
PF5	PF5	1B 35H
PF6	PF6	1B 36H
PF7	PF7	1B 37H
PF8	PF8	1B 38H
PF9	PF9	1B 39H
PF10	PF10	1B 30H
PF11	PF11	1B 2DH
PF12	PF12	1B 3DH
PF13	PF13	1B 51H
PF14	PF14	1B 57H
PF15	PF15	1B 45H
PF16	PF16	1B 52H
PF17	PF17	1B 54H
PF18	PF18	1B 59H
PF19	PF19	1B 55H
PF20	PF20	1B 49H
PF21	PF21	1B 4FH
PF22	PF22	1B 50H
PF23	PF23	1B 46H
PF24	PF24	1B 47H
PA1	PA1	1B 5AH
PA2	PA2	1B 58H
PA3	ESC C	1B 43H
Print	PRINT	1B 56H
Cursor Select	SELECT	1B 2FH
Attention	ESC \	1B 5CH
Device Cancel	ESC }	1B 7DH
Ident	IDENT	1B 53H
Test	TEST	1B 16H
Special Function	Key Sequence	Hex Value Generated
Numeric Override	ESC {	1B 7BH
Refresh Screen	ALT/Z	1AH
Initialize Terminal	ESC <	1B 3CH
Display Status Line	ESC _ (underline)	1B 5FH

G.28 I3101 Terminal Module—IBM 3101

To set up the IBM 3101 terminal for connection to the A/C-4 (B) in order to emulate the 3278, proceed as follows:

1. Disconnect the AC power cord from the outlet before starting the setup process.
2. There are 8 toggle-type switches located on the keyboard element as Group 1 switches. These switches describe the communications connect options and are set to the following values:

Group 1 Switches	Set to:	Comments
CHAR-BLOCK	CHAR	A/-4 (B) supports only TTY-compatible character interfaces
FDX-HDX	FDX	Full-duplex operations enabled
CL422-232C	232C	Sets EIA RS-232C option
CRTS-PRTS	PRTS	RTS held continuously high
REV CHAN ON-OFF	REV CHAN OFF	Operations enabled without reverse channel
LINE TURN AROUND	CR	Set Sw 6 = 0, Sw 7 = 1
CHARS (Sw 6 - 7)		
MONO-DUAL	DUAL	Sets dual-case character set

3. There are 8 toggle switches located on the keyboard element as GROUP 2 switches. These switches describe the terminal operating characteristics and are set to the following values:

Group 2 Switches	Set to:	Comments
STOP1-STOP2	STOP 1	Set to 1 stop bit unless 110 baud rate is desired. In this case use STOP 2.
PARITY	as desired	SPACE Sw2 = 0, Sw3 = 0 MARK Sw2 = 0, Sw3 = 1 ODD Sw2 = 1, Sw3 = 0 EVEN Sw2 = 1, Sw3 = 1
SENDLINE OPTION	OFF	Sets normal send function
NULL SUPPRESSION	OFF	All nulls not suppressed
TIMEFILL CHARS (Sw 7 - 8)	0	No time fill characters set: Sw7 = 0, Sw8 = 0

4. There are 8 toggle switches located on the keyboard element as GROUP 3 switches. These switches describe the functional terminal operating characteristics and are set to the following values:

Group 3 Switches	Set to:	Comments
AUTO NL ON-OFF	OFF	Automatic generation of New Line disabled
AUTOLF ON-OFF	OFF	Automatic generation of line feed disabled
CR/CR-LF	CR	Disable automatic generation of a line feed character every time a carriage return is keyed
SCROLL ON-OFF	OFF	Scrolling disabled
REVERSE VIDEO ON-OFF	as desired	Video capability
BLINK CURSOR ON-OFF	as desired	Cursor characteristic

A/C-4 (B)

5. There are 8 toggle switches located on the keyboard element as GROUP 4 switches. These switches describe the baud rates needed for both primary and auxiliary communication interfaces. The following table describes how to set the terminal baud rate in order for the terminal to interface with the A/C-4 (B).

I/O Baud Rate (BPS)	MAIN PORT Switch Settings				AUXILIARY PORT Switch Settings			
	1	2	3	4	5	6	7	8
110	OFF	OFF	OFF	OFF	OFF	OFF	OFF	OFF
300	OFF	OFF	ON	ON	OFF	OFF	ON	ON
1200	OFF	ON	OFF	ON	OFF	ON	OFF	ON
2400	OFF	ON	ON	ON	OFF	ON	ON	ON
4800	ON	OFF	OFF	OFF	ON	OFF	OFF	OFF
9600	ON	OFF	OFF	ON	ON	OFF	OFF	ON

The baud rate set into the above switches must match the baud rate specified for the A/C-4 (B) port to which this terminal is to be connected. It is recommended that the highest valid baud rate (matching for both A/C-4 (B) and the terminal) be selected. If a baud rate of 110 is selected, be sure the number of stop bits is 2. (See STOP 2 switch specified in the GROUP 2 Switches.)

6. Reconnect the AC power cord and connect the terminal to the A/C-4 (B) port (modem or direct cable) as appropriate.

Keyboard Emulation

Following is a table showing how the IBM 3101 keyboard is used in emulation of the 3278 keyboard.

NOTES:

1. Press <Alt> concurrently with the indicated key.
2. Press <Esc> prior to pressing the indicated key.

3278 Function	Key Sequence	Hex Value Generated
Reset	ALT/R	12H
Backspace Cursor	←	1B 44H
Down Cursor	↓	1B 42H
Up Cursor	↑	1B 41H
Forward Space Cursor	→	1B 43H
Home	HOME symbol	1B 48H
Tab	→I	09H
Back Tab	←(backspace)	08H
Delete	DEL	7FH
New Line	ALT/N	0EH
Duplicate	ALT/D	04H
Field Mark	ALT/F	06H
Insert Mode	ALT/U	15H
Erase to End of Field	ERASE EOL/EOF	1B 49H
Erase Input	ERASE INPUT	1B 4BH
Enter	← (new line)	0DH
Clear	CLEAR	1B 4CH
Sys Request	ESC ?	1B 3FH
PF1	PF1	1B 61 0DH
	or ESC 1	1B 31H

3278 Function	Key Sequence	Hex Value Generated
PF2	PF2 1B 62 or ESC 2	0DH 1B 32H
PF3	PF3 1B 63 or ESC 3	0DH 1B 33H
PF4	PF4 1B 64 or ESC 4	0DH 1B 34H
PF5	PF5 1B 65 or ESC 5	0DH 1B 35H
PF6	PF6 1B 66 or ESC 6	0DH 1B 36H
PF7	PF7 1B 67 or ESC 7	0DH 1B 37H
PF8	PF8 1B 68 or ESC 8	0DH 1B 38H
PF9	ESC 9	1B 39H
PF10	ESC 0	1B 30H
PF11	ESC !	1B 21H
PF12	ESC @	1B 40H
PF13	ESC #	1B 23H
PF14	ESC \$	1B 24H
PF15	ESC %	1B 25H
PF16	ESC ^	1B 5EH
PF17	ESC &	1B 26H
PF18	ESC *	1B 2AH
PF19	ESC (1B 28H
PF20	ESC)	1B 29H
PF21	ESC ESC 1	1B 1B 31H
PF22	ESC ESC 2	1B 1B 32H
PF23	ESC ESC 3	1B 1B 33H
PF24	ESC ESC 4	1B 1B 34H
PA1	ERASE EOS 1	1B 4A 31H
PA2	ERASE EOS 2	1B 4A 32H
PA3	ERASE EOS 3	1B 4A 33H
Print	ALT/P	10H
Cursor Select	ALT/C	03H
Attention	ESC \	1B 5CH
Device Cancel	ESC]	1B 5DH
Ident	ESC :	1B 3AH
Test	ESC ; or ESC CTRL/U	1B 3BH 1B 15H
Special Function	Key Sequence	Hex Value Generated
Numeric Override	ESC [1B 5BH
Refresh Screen	ALT/W	17H
Initialize Terminal	ESC <	1B 3CH
Local Device Print	PRINT	1B 57H
Display Status Line	ESC _ (underline)	1B 5FH

G.29 I3161 Terminal Module—IBM 3161/3163

To set up the IBM 3161/3163 terminal for connection to A/C-4 (B) in order to emulate the 3278, proceed as follows:

All operator-selectable options are input from the keyboard into the Setup and Select menus; there are no external switches.

1. Enter the Setup Menu by pressing the Setup keys <Ctrl> and <Select>. Set the options as follows:

Parameter Menu	Set to:	Comments
Machine Mode	IBM 3161/3163	For 3161/3163 operation
Operating Mode	ECHO	ECHO, or conversational mode, with A/C-4 (B) handling the echo of the keyboard input
Interface	RS-232C	EIA RS-232C communication interface
Line Control	as desired	PRTS-permanent RTS CRTS-controlled RTS IPRTS-induced permanent RTS
Line Speed	as desired	Main and Aux. Port baud rate (110-19.2K bps)
Parity	as desired	Main and Aux. Port (Space, Mark, Odd, Even or No)
Turnaround Character	Not Applic.	Line turnaround character to be sent at end of read type command
Stop Bit	as desired	Main and Aux port. 1 or 2 bits
Word Length	as desired	Main and Aux port. 7 or 8 bits
Response Delay	as desired	0 or 100 msec.
Break Signal	as desired	170 or 500 msec.

2. Enter the Select Menu by pressing the Select key. Set the options as follows:

Parameter Menu	Set to:	Comments
Enter	RETURN	Enter key functions as Return key
Return	NEW LINE	New Line option functions when Return key is pressed
New Line	CR	Return (and Enter) key generates a CR character
Tab	as desired	Field or Column (overridden by A/C-4 (B))
Line Wrap	OFF	Auto Line Wrap is disabled
Auto LF	OFF	Upon receipt of a CR character, only a carriage return (and not a carriage return, line feed) is performed by the terminal
Send	Not Applicable	Not applicable in Echo Mode
Send Null	Not Applicable	Not applicable in Echo Mode
Insert	Not Applicable	Not applicable as the Insert key is not used by A/C-4 (B) emulation
Trace	Not Applicable	Not applicable as it does not affect communication to A/C-4 (B)
CRT Saver	Not Applicable	Overridden by A/C-4 (B)
Scroll	OFF	Auto scroll is disabled
Print	Not Applicable	Not applicable as the Print key is not used by A/C-4 (B) emulation
Print EOL	OFF	No end-of-line character sent to the printer by the terminal
Line End	Not Applicable	Not applicable as the Print EOL option is disabled

Keyboard Emulation

Following is a table showing how the IBM 3161/3163 keyboard is used in emulation of the 3278 keyboard.

NOTES:

1. Press <Ctrl> concurrently with the indicated key.
2. Press <Esc> prior to pressing the indicated key.

3278 Function	Key Sequence	Hex Value Generated
Reset	CTRL/R	12H
Backspace Cursor	←	1B 44H
Down Cursor	↓	1B 42H
Up Cursor	↑	1B 41H
Forward Space Cursor	→	1B 43H
Home	HOME	1B 48H
Tab	TAB →	09H
Back Tab	← TAB	1B 32H
Delete	DELETE	1B 51H
New Line	LF	0AH
Duplicate	CTRL/D	04H
Field Mark	CTRL/F	06H
Insert Mode	INS LN	1B 4EH
Erase to End of Field	ERASE EOF	1B 49H
Erase Input	ER INP	1B 4BH
Enter	←'RETURN or ENTER	0DH
Clear	CLEAR	1B 4C 0DH
Sys	Request ESC ?	1B 3FH
PF1	F1	1B 61 0DH
PF2	F2	1B 62 0DH
PF3	F3	1B 63 0DH
PF4	F4	1B 64 0DH
PF5	F5	1B 65 0DH
PF6	F6	1B 66 0DH
PF7	F7	1B 67 0DH
PF8	F8	1B 68 0DH
PF9	F9	1B 69 0DH
PF10	F10	1B 6A 0DH
PF11	F11	1B 6B 0DH
PF12	F12	1B 6C 0DH
PF13	SHIFT/F1	1B 21 61 0DH
PF14	SHIFT/F2	1B 21 62 0DH
PF15	SHIFT/F3	1B 21 63 0DH
PF16	SHIFT/F4	1B 21 64 0DH
PF17	SHIFT/F5	1B 21 65 0DH
PF18	SHIFT/F6	1B 21 66 0DH
PF19	SHIFT/F7	1B 21 67 0DH
PF20	SHIFT/F8	1B 21 68 0DH
PF21	SHIFT/F9	1B 21 69 0DH
PF22	SHIFT/F10	1B 21 6A 0DH
PF23	SHIFT/F11	1B 21 6B 0DH
PF24	SHIFT/F12	1B 21 6C 0DH

A/C-4 (B)

3278 Function	Key Sequence	Hex Value Generated
PA1	PA1	1B 21 6D 0DH
PA2	PA2	1B 21 6E 0DH
PA3	PA3	1B 21 6F 0DH
Print	SEND	1B 38 0DH
Cursor Select	CTRL/C	03H
Attention	ESC \	1B 5CH
Device Cancel	ESC]	1B 5DH
Ident	ESC :	1B 3AH
Test	ESC ;	1B 3BH
Special Function	Key Sequence	Hex Value Generated
Numeric Override	ESC [1B 5BH
Refresh Screen	CTRL/W	17H
Initialize Terminal	ESC <	1B 3CH
Local Device Print	SEND LINE	1B 21 38 0DH
Display Status Line	ESC _ (underline)	1B 5FH

G.30 IBMPC Terminal Module—IBM Personal Computer

Terminal-emulation and file-transfer software is available for the IBM Personal Computer and compatibles. This software emulates an IBM 3278 Model 2 Display Station.

The IBMPC terminal driver permanently displays the status line. Therefore, key commands are not required.

Keyboard Emulation

The following table shows how the IBM PC keyboard is used emulate an IBM 3278 keyboard. The 3278 functions required are listed in column one. The key used to produce each function is listed in column two. The characters transmitted to perform the function are shown in hex code in column three.

NOTES:

1. Press <Ctrl> concurrently with the indicated key.
2. Press <Alt> concurrently with the indicated key.
3. Press <Esc> prior to pressing the indicated key.

3278 Function	Key Sequence	Hex Value Generated
Reset	F9 or CTRL/R	12H
Backspace Cursor	NK ←	08H
Down Cursor	NK ↓	0AH
Up Cursor	NK ↑	0BH
Forward Space Cursor	NK →	0CH
Home	NK HOME	1EH
Tab	TAB	14H
Back Tab	SHIFT TAB	02H
Delete	NK DELETE	7FH
New Line	NK +	0EH
Duplicate	CTRL/D	04H
Field Mark	CTRL/F	06H
Insert Mode	NK Ins	15H
Erase to End of Field	F6	05H
Erase Input	F5	18H
Enter	F10 or RETURN	0DH
Clear	F4	1B 5EH
Sys Request	ESC ?	1B 3FH
PF1	ALT/1	1B 31H
PF2	ALT/2	1B 32H
PF3	ALT/3	1B 33H
PF4	ALT/4	1B 34H
PF5	ALT/5	1B 35H
PF6	ALT/6	1B 36H
PF7	ALT/7	1B 37H
PF8	ALT/8	1B 38H
PF9	ALT/9	1B 39H
PF10	ALT/0	1B 30H
PF11	ALT/Q	1B 51H
PF12	ALT/W	1B 57H
PF13	ALT/E	1B 45H
PF14	ALT/R	1B 52H

A/C-4 (B)

3278 Function	Key Sequence	Hex Value Generated
PF15	ALT/T	1B 54H
PF16	ALT/Y	1B 59H
PF17	ALT/U	1B 55H
PF18	ALT/I	1B 49H
PF19	ALT/O	1B 4FH
PF20	ALT/P	1B 50H
PF21	ALT/A	1B 41H
PF22	ALT/S	1B 53H
PF23	ALT/D	1B 44H
PF24	ALT/F	1B 46H
PA1	F1 or ALT/Z	1B 5AH
PA2	F2 or ALT/X	1B 58H
PA3	F3 or ALT/C	1B 43H
Print	CTRL/P	10H
Cursor Select	F8 or CTRL/C	03H
Device Cancel	ESC]	1B 5DH
Attention	ESC \	1B 5CH
Ident	ESC :	1B 3AH
Test	ESC ;	1B 3BH
Special Function	Key Sequence	Hex Value Generated
Numeric Override	ESC [1B 5BH
Refresh Screen	CTRL/W	17H
Initialize Terminal	ESC <	1B 3CH
Display Status Line	(No)*	(None)

G.31 INF205 Terminal Module—Informer 205/207

To determine the Informer® 205 terminal switch settings, please refer to the Informer 205 User’s Manual and the General Notes on Terminal Switch Settings section of the Introduction to this document, or contact your supplier.

Keyboard Emulation

Following is a table showing how the Informer 205 keyboard is used in emulation of the 3278 keyboard.

NOTES:

1. Press <Alt> concurrently with the indicated key.
2. Press <Esc> prior to pressing the indicated key.
3. The Informer 207 Portable Terminal keyboard has no ESC key. To generate an ASCII ESC = 1BH, press concurrently the <Alt> and <¢> keys.

3278 Function	Key Sequence	Hex Value Generated
Reset	RESET	1B 01H
Backspace	←	1B 5B 44H
or	←←	08H
Down Cursor	↓	1B 5B 42H
Up Cursor	↑	1B 5B 41H
Forward Space Cursor	→	1B 5B 43H
Home	HOME	01H
Tab	TAB	09H
Backtab	BACKTAB	0FH
Delete	DEL	7FH
New Line	NEW LINE	0AH
Duplicate	DUP	0EH
Field Mark	FIELD MARK	17H
Insert Mode	INSERT	19H
Erase to End of Field	ERASE EOF	18H
Erase Input	ERASE INPUT	12H
Enter	ENTER	0DH
Clear	CLEAR	1B 4DH
Sys Request	SYS REQ	1B 3BH
PF1	PF1	1B 31H
PF2	PF2	1B 32H
PF3	PF3	1B 33H
PF4	PF4	1B 34H
PF5	PF5	1B 35H
PF6	PF6	1B 36H
PF7	PF7	1B 37H
PF8	PF8	1B 38H
PF9	PF9	1B 39H
PF10	PF10	1B 30H
PF11	PF11	1B 2DH
PF12	PF12	1B 3DH
PF13	PF13	1B 51H
PF14	PF14	1B 57H
PF15	PF15	1B 45H

A/C-4 (B)

3278 Function	Key Sequence	Hex Value Generated
PF16	PF16	1B 52H
PF17	PF17	1B 54H
PF18	PF18	1B 59H
PF19	PF19	1B 55H
PF20	PF20	1B 49H
PF21	PF21	1B 4FH
PF22	PF22	1B 50H
PF23	PF23	1B 46H
PF24	PF24	1B 47H
PA1	PA1	1B 5AH
PA2	PA2	1B 58H
PA3	PA3	1B 4EH
Print	or ESC C PRINT	1B 43H 1B 56H
Cursor Select	CTRL/C	03H
Attention	ESC \	1B 5CH
Device Cancel	ESC]	1B 5DH
Ident	IDENT or ESC :	1B 53H 1B 3AH
Test	ESC +	1B 2BH
Special Function	Key Sequence	Hex Value Generated
Numeric Override	ESC {	1B 7BH
Refresh Screen	ALT/Z	1AH
Initialize Terminal	ESC <	1B 3CH
Display Status Line	ESC _ (underline)	1B 5FH

G.32 SCANS Terminal Module—Tymshare Scanset

To set up the SCANSET terminal for connection to the A/C-4 (B) in order to emulate the 3278, proceed as follows.

All parameters of the SCANSET terminal are set from the keyboard while in Status Mode. For details on how to access Status Mode and enter values, please refer to the manufacturer's SCANSET User's Manual Set the parameters to the following values:

Parameter	Value	Comments
Baud TX	as desired	Transmission Baud Rate
Baud RX	as desired	Reception Baud Rate
Baud Print	as desired	Printer Baud Rate
Dial - Pulse/Tone	as required	Pulse = terminal connected to a rotary dial phone line Tone = touchtone phone line
Bit TX/RX	as desired	Number of data bits transmitted to the connected printer
PAR Print	as desired	Type of parity: ODD, EVEN, NONE
Brightness	as desired	Brightness of display: 0 = minimum, 3 = maximum
Beep Col	as desired	YES = beep at 72nd character entered in a line NO = beep disabled
Beep Tone	as desired	Volume of the beep: 0 = minimum, 3 = maximum
Cursor	ESC	ESC sequence transmitted when a cursor key is pressed
Return Key	CR	CR transmitted when RETURN key is pressed
Screen Size	80	80-column screen
Duplex	FULL	Full Duplex transmission
Scroll	NO	Disables Scrolling
XON/XOFF	as desired	Set to match logical flow control selection configured for the A/C-4 (B) port

Keyboard Emulation

Following is a table showing how the SCANSET keyboard is used in emulation of the 3278-2 keyboard.

NOTES:

1. Press <Ctrl> concurrently with the indicated key.
2. Press <Esc> prior to pressing the indicated key.
3. The last character on the screen (the line 24, column 80 character position) cannot be displayed. This feature is designed to defeat the SCANSET Auto-Scroll capability.

A/C-4 (B)

3278 Function	Key Sequence	Hex Value Generated
Reset	CTRL/R or PF LOAD	12H 1B 24 ODH
Backspace Cursor	←	1B 44H
Down Cursor	↓	1B 42H
Up Cursor	↑	1B 41H
Forwardspace Cursor	→	1B 43H
Home	HOME(F5)	1EH
Tab	TAB(F6)	09H
Backtab	BACKSPACE	08H
Delete	DELETE	7FH
New Line	LINE FEED	0AH
Duplicate	CTRL/D	04H
Field Mark	CTRL/F	06H
Insert Mode	CTRL/U	15H
Erase to End of Field	CTRL/E	05H
Erase Input	CTRL/X	18H
Enter	RETURN	0DH
Clear	CLEAR(F4)	1B 4AH
System Request	ESC ?	1B 3FH
PF1	ESC 1	1B 31H
PF2	ESC 2	1B 32H
PF3	ESC 3	1B 33H
PF4	ESC 4	1B 34H
PF5	ESC 5	1B 35H
PF6	ESC 6	1B 36H
PF7	ESC 7	1B 37H
PF8	ESC 8	1B 38H
PF9	ESC 9	1B 39H
PF10	ESC 0	1B 30H
PF11	ESC !	1B 21H
PF12	ESC @	1B 40H
PF13	ESC #	1B 23H
PF14	ESC F	1B 46H
PF15	ESC %	1B 25H
PF16	ESC ^	1B 5EH
PF17	ESC &	1B 26H
PF18	ESC *	1B 2AH
PF19	ESC (1B 28H
PF20	ESC)	1B 29H
PF21	ESC Q	1B 51H
PF22	ESC W	1B 57H
PF23	ESC E	1B 45H
PF24	ESC R	1B 52H
PA1	PA1 (F1)	1B 5AH
PA2	PA2 (F2)	1B 58H
PA3	PA3 (F3)	1B 56H
Print	CTRL/P	10H
Cursor Select	CTRL/C	03H
Attention	ESC \	1B 5CH
Device Cancel	ESC]	1B 5DH
Ident	ESC :	1B 3AH
Test	ESC ;	1B 3BH

Special Function	Key Sequence	Hex Value Generated
Numeric Override	ESC [1B 5BH
Refresh Screen	CTRL/W	17H
Initialize Terminal	ESC <	1B 3CH
Display Status Line	ESC _ (underline)	1B 5FH

G.33 T4420 Terminal Module—Teletype 4420/4424

The Teletype 4420 has no option switches; rather, its options are selected through the keyboard. Refer to the manufacturer's manual for information as to how to access and modify the Option Selection Table. Set the option values to the following:

Option Number	Value	Comments
201	as desired	Sets the terminal baud rate
202	a	Asynchronous transmission
203	as desired	Disconnect on Loss of Carrier
204	as desired	Printer on Auto Answer
205	as desired	Substitute Character on Parity Error
206	a	Send Cursor and Edit controls from keyboard
207	as desired	Parity: EVEN, ODD, MARK, SPACE.
208	k	No end character for Message Send to Online Data Preparation
209	k	No end character for Message Send to Interactive
210	k	No end character for Interactive to Message Send
211	k	No end character for Interactive to Online Data Preparation
212	c	No disconnect character
213	b	CR/LF Line ending sequence
214	b	No display of data sent from keyboard
215	b	DC3 stop, DC1 start Display Send Control
216	b	DC3 stop, DC1 start Buffer Full Response
217 - 220	not used	
221	as desired	Position of NL and RETURN keys (choose either a. or b.)
222	a	Row, then column Cursor Addressing
223 - 228	b	No codes stored
229	c	ESC sequences performed but not stored
230	a	Data unprotected as displayed, protected without delimiters
231	b	No auto transmission of NL at 80th column
232	b	Send protected controls unprotected
233	a	Send highlight delimiters
234	b	No answerback on Auto Answer
235	a	Message Send from Cursor
236	b	Printer not affected by DC2 and DC4 characters
237	as desired	Auto Select of Speed and Options Group with
212L1A		
238	b	Keyboard send in Interactive Mode
239 - 241	not used	
300 - 302	as desired	Printer Option settings will depend on the type of printer being used

Keyboard Emulation

Following is a table showing how the Teletype 4420/4424 keyboards are used in emulation of the 3278 keyboard.

NOTES:

1. Press <Ctrl> concurrently with the indicated key.
2. Press <Esc> prior to pressing the indicated key.

3278 Function	Key Sequence	Hex Value Generated
Reset	CTRL/R or ESC R	12H 1B 52H
Backspace Cursor	← or ESC D	08H 1B 44H
Down Cursor	↓	1B 42H
Up Cursor	↑	1B 41H
Forward Space Cursor	→	1B 43H
Home	HOME	1B 48H
Tab	TAB	09H
Backtab	BACKTAB	1B 4FH
Delete	DELETE or CHAR DEL or ESC P	7FH 1B 50H
New Line	NEW LINE	0AH
Duplicate	CTRL/D	04H
Field Mark	CTRL/F	06H
Insert Mode	CHAR INS	1B 5EH
Erase to End of Field	LINE DELETE	1B 4DH
Erase Input	CTRL/X	18H
Enter	RETURN	0DH
Clear	CLEAR	1B 4AH
Sys Request	ESC ?	1B 3FH
PF1	ESC 01	1B 30 31H
PF2	ESC 02	1B 30 32H
PF3	ESC 03	1B 30 33H
PF4	ESC 04	1B 30 34H
PF5	ESC 05	1B 30 35H
PF6	ESC 06	1B 30 36H
PF7	ESC 07	1B 30 37H
PF8	ESC 08	1B 30 38H
PF9	ESC 09	1B 30 39H
PF10	ESC 10	1B 31 30H
PF11	ESC 11	1B 31 31H
PF12	ESC 12	1B 31 32H
PF13	ESC 13	1B 31 33H
PF14	ESC 14	1B 31 34H
PF15	ESC 15	1B 31 35H
PF16	ESC 16	1B 31 36H
PF17	ESC 17	1B 31 37H
PF18	ESC 18	1B 31 38H
PF19	ESC 19	1B 31 39H
PF20	ESC 20	1B 32 30H
PF21	ESC 21	1B 32 31H

A/C-4 (B)

3278 Function	Key Sequence	Hex Value Generated
PF22	ESC 22	1B 32 32H
PF23	ESC 23	1B 32 33H
PF24	ESC 24	1B 32 34H
PA1	ESC P1	1B 50 31H
PA2	ESC P2	1B 50 32H
PA3	ESC P3	1B 50 33H
Print	CTRL/P	10H
Cursor Select	CTRL/C	03H
Attention	ESC \	1B 5CH
Device Cancel	ESC]	1B 5DH
Ident	ESC :	1B 3AH
Test	ESC ;	1B 3BH
Special Function	Key Sequence	Hex Value Generated
Numeric Override	ESC [1B 5BH
Refresh Screen	CTRL/W	17H
Initialize Terminal	ESC <	1B 3CH
Display Status Line	ESC _ (underline)	1B 5FH

G.34 T5410 Terminal Module—AT&T Teletype 5410

The Teletype 5410 has no option switches; rather, its options are selected through the keyboard. Refer to the manufacturer’s manual for information as to how to access and modify the Options Menu. Set the options values to the following:

Options	Value	Comments
SPEED	as desired	Baud = 300, 1200, 2400, 4800, 9600, 19200.
RETURN KEY	CR	RETURN key generates an ASCII CR character.
PARITY	as desired	Parity = Even, Odd, Mark, Space, None.
REC'VD LF	INDEX	Upon receipt of a LF character, the cursor will be positioned in the same column of the next line.
DUPLEX	FULL	Full Duplex operation.
CURSOR	as desired	Block or Blink.
SCREEN FORMAT	as desired	80 vs. 132 column—set/reset by the A/C-4 (B).
AUTOWRAP	OFF	Disable autowrap features.
TRANSPARENT	OFF	Escape sequences and Control characters are not displayed, but are acted on.
KEYCLICK	as desired	Programmable Function Key sequences and labels are set by A/C-4 (B) in its terminal initialization.

Keyboard Emulation

Following is a table showing how the Teletype 5410 keyboard is used in emulation of the 3278 keyboard.

NOTES:

1. Press <Ctrl> concurrently with the indicated key.
2. Press <Esc> prior to pressing the indicated key.
3. The second character of the ESC sequence PF key assignments is based on the first two-and-one-half rows of alphanumeric keys being treated as a matrix, thus:

row 1 (1-0) = PF1 - PF10
 row 2 (Q-P) = PF11 - PF20
 row 3 (A-F) = PF21 - PF24

Similarly, the PA key assignments have, as their second key, the first three characters on the fourth row of alpha keys (Z,X,C). Either lower-case or upper-case (shifted) alpha characters are valid.

3278 Function	Key Sequence	Hex Value Generated
Reset	CTRL/R	12H
Backspace Cursor	← or BACKSPACE	1B 5B 44H 08H
Down Cursor	↓	1B 5B 42H
Up Cursor	↑	1B 5B 41H
Forward Space Cursor	→	1B 5B 43H
Home	HOME	1B 5B 48H
Tab	TAB	09H
Backtab	CTRL/B	02H
Delete	DELETE	7FH
New Line	LINE FEED	0AH
Duplicate	CTRL/D	04H
Field Mark	CTRL/F	06H

A/C-4 (B)

3278 Function	Key Sequence	Hex Value Generated
Insert Mode	CTRL/U	15H
Erase to End of Field	CTRL/E	05H
Erase Input	CTRL/X	18H
Enter	RETURN	0DH
Clear	ESC ^	1B 5EH
Sys Request	ESC ?	1B 3FH
PF1	PF1	1B 31H
PF2	PF2	1B 32H
PF3	PF3	1B 33H
PF4	PF4	1B 34H
PF5	PF5	1B 35H
PF6	PF6	1B 36H
PF7	PF7	1B 37H
PF8	PF8	1B 38H
PF9	ESC 9	1B 39H
PF10	ESC 0	1B 30H
PF11	ESC Q	1B 51H
PF12	ESC W	1B 57H
PF13	ESC E	1B 45H
PF14	ESC R	1B 52H
PF15	ESC T	1B 54H
PF16	ESC Y	1B 59H
PF17	ESC U	1B 55H
PF18	ESC I	1B 49H
PF19	ESC L	1B 4CH
PF20	ESC P	1B 50H
PF21	ESC A	1B 41H
PF22	ESC S	1B 53H
PF23	ESC D	1B 44H
PF24	ESC F	1B 46H
PA1	ESC Z	1B 5AH
PA2	ESC X	1B 58H
PA3	ESC C	1B 43H
Print	CTRL/P	10H
Cursor Select	CTRL/C	03H 1B 5CH
Attention	ESC \	1B 5CH
Device Cancel	ESC]	1B 5DH
Ident	ESC :	1B 3AH
Test	ESC ;	1B 3BH
Special Function	Key Sequence	Hex Value Generated
Numeric Override	ESC {	1B 7BH
Refresh Screen	CTRL/W	17H
Initialize Terminal	ESC <	1B 3CH
Display Status Line	ESC _ (underline)	1B 5FH

G.35 T5420 Terminal Module—AT&T Teletype 5420

The Teletype 5420 has no option switches; rather, its options are selected through the keyboard. Refer to the manufacturer's manual for information as to how to access and modify the Terminal Options Menu. Set the options values to the following:

Options	Value	Comments
SPEED	as desired	Baud = 110, 300, 1200, 2400, 4800, 9600, 19200
DUPLEX	FULL	Full Duplex Operation
SEND PARITY	as desired	Parity = Even, Odd, Mark, Space
CHECK PARITY	as desired	Set to match parity selection configured for A/C-4 (B) port
132 COLUMN	OFF	Terminal will power up into 80-column mode
MEMORY ACCESS	as desired	Scroll, Page or Window
CLOCK	Async	Baud rate set by terminal
RETURN KEY	CR	RETURN key generates an ASCII CR character
NEWLINE on LF	NO	Terminal executes a cursor index upon receipt of a LF character
AUTOWRAP	OFF	Autowrap feature is disabled
CURSOR	as desired	Blinking vs. Solid
KEYCLICK	as desired	
MARGIN BELL	n.a.	Local Function only
KEYBOARD MODEL	5420	
TRANSMISSION	CHAR	Terminal transmits on a character by character basis
LINE SEND	n.a.	Applicable only if in LINE mode
BLOCK SEND	n.a.	Applicable only if in BLOCK mode
SEND FROM	n.a.	Applicable only if in BLOCK mode
SENDEDIT SEQ	YES	Terminal transmits all ESC sequences generated by edit keys
SEND GRAPHICS	n.a.	Applicable only if in BLOCK mode
ENTER KEY	LF character	ENTER key generates an ASCII LF character. To enter this parameter, press Ctrl/J when in this parameter's field.
FIELD SEPARATOR	n.a.	Applicable only if in BLOCK or LINE mode
BLOCK TERMINATOR	n.a.	Applicable only if in BLOCK mode
ANSWERBACK	n.a.	Transmitted upon receipt of an ENQ character
LINES PER PAGE	n.a.	Applicable only when Pagination selected
PAGINATION	OFF	Pagination function disabled
PRINTER MODEL	as desired	None, Normal, or Graphic
PRINTER SPEED	as desired	Baud = 300, 1200, 2400, 4800, 9600
FLOW CONTROL	as desired	Set to match logical flow control selection configured for the A/C-4 (B) port
ALARM	as desired	Set to match configuration for the A/C-4 (B) port

Keyboard Emulation

Following is a table showing how the Teletype 5420 keyboard is used in emulation of the 3278 keyboard.

NOTES:

1. Press <Ctrl> concurrently with the indicated key.
2. Press <Esc> prior to pressing the indicated key.
3. The second character of the ESC sequence PF key assignments is based on the first two-and-one-half rows of alphanumeric keys being treated as a matrix, thus:

row 1 (1-0) = PF1 - PF10
 row 2 (Q-P) = PF11 - PF20
 row 3 (A-F) = PF21 - PF24

Similarly, the PA key assignments have, as their second key, the first three characters on the fourth row of alpha keys (Z, X, C). Either lower-case or upper-case (shifted) alpha characters are valid.

3278 Function	Key Sequence	Hex Value Generated
Reset	CTRL/R	12H
Backspace Cursor	← or BACKSPACE	1B 5B 44H 08H
Down Cursor	↓	1B 5B 42H
Up Cursor	↑	1B 5B 41H
Forward Space Cursor	→	1B 5B 43H
Home	HOME	1B 5B 48H
Tab	TAB	09H
Backtab	BACKTAB	1B 5B 5AH
Delete	DELETE	7FH
New Line	RETURN	0DH
Duplicate	CTRL/D	04H
Field Mark	CTRL/F	06H
Insert Mode	INS LINE	1B 5B 4CH
Erase to End of Field	DELETE WORD	1B 64H
Erase Input	DELETE LINE	1B 5B 4DH
Enter	ENTER	0AH
Clear	ESC ^	1B 5EH
Sys Request	ESC ?	1B 3FH
PF1	PF1	1B 31H
PF2	PF2	1B 32H
PF3	PF3	1B 33H
PF4	PF4	1B 34H
PF5	PF5	1B 35H
PF6	PF6	1B 36H
PF7	PF7	1B 37H
PF8	PF8	1B 38H
PF9	ESC 9	1B 39H
PF10	ESC 0	1B 30H
PF11	ESC Q	1B 51H
PF12	ESC W	1B 57H
PF13	ESC E	1B 45H
PF14	ESC R	1B 52H
PF15	ESC T	1B 54H

3278 Function	Key Sequence	Hex Value Generated
PF16	ESC Y	1B 59H
PF17	ESC U	1B 55H
PF18	ESC I	1B 49H
PF19	ESC L	1B 4CH
PF20	ESC P	1B 50H
PF21	ESC A	1B 41H
PF22	ESC S	1B 53H
PF23	ESC D	1B 44H
PF24	ESC F	1B 46H
PA1	ESC Z	1B 5AH
PA2	ESC X	1B 58H
PA3	ESC C	1B 43H
Print	CTRL/P	10H
Cursor Select	CTRL/C	03H 1B 5CH
Attention	ESC \	1B 5CH
Device Cancel	ESC]	1B 5DH
Ident	ESC :	1B 3AH
Test	ESC ;	1B 3BH
Special Function	Key Sequence	Hex Value Generated
Numeric Override	ESC {	1B 7BH
Refresh Screen	CTRL/W	17H
Initialize Terminal	ESC <	1B 3CH
Display Status Line	ESC _ (underline)	1B 5FH

G.36 TV910 Terminal Module—TeleVideo TV910

To set up the TeleVideo 910 terminal for connection to the A/C-4 (B) in order to emulate the 3278, proceed as follows:

1. Disconnect the AC power cord from the outlet before opening the TeleVideo terminal case.
2. There are two sets of 10 switches on the TeleVideo 910, labeled S1 and S2. Set these switches in the following manner.

S1 (right rear)	Set to:	Comments
1 - 4	—	Baud rate—see chart below
5	DOWN	8 data bits
6	as desired	End parity—UP
7	as desired	No parity—DOWN (set to match A/C-4 (B))
8	DOWN	EVEN parity—UP
9	DOWN	ODD parity—DOWN (set to match A/C-4 (B))
10	DOWN	1 stop bit (if baud rate is 110, set UP for 2 stop bits)
		Auto wrap off
		Auto Linefeed off

Baud Rate	1	2	3	4
110	DOWN	DOWN	UP	UP
300	DOWN	UP	UP	DOWN
1200	UP	DOWN	DOWN	DOWN
2400	UP	DOWN	UP	DOWN
4800	UP	UP	DOWN	DOWN
9600	UP	UP	UP	DOWN
19200	UP	UP	UP	UP

S2 (left rear)	Set to:	Comments
1	DOWN	1 and 2—Sets standard 910 emulation
2	DOWN	
3	as desired	50 Hz: DOWN (international) 60 Hz: UP (U.S.)
4	as desired	UP = Steady cursor DOWN = Blinking cursor
5	as desired	UP = Underline cursor DOWN = Block cursor
6	UP	Full Duplex
7	as desired	UP = White on black DOWN = Black on white
8	UP	No DSR
9	DOWN	DCD connected
10	DOWN	DTR on with terminal

3. Replace the cover, reconnect the AC power cord, and connect the terminal to the A/C-4 (B) port (or modem, etc.), as appropriate.

Keyboard Emulation

Following is a table showing how the TeleVideo 910 keyboard is used in emulation of the 3278 keyboard.

NOTES:

1. Press <Ctrl> concurrently with the indicated key.
2. Press <Esc> prior to pressing the indicated key.
3. The second character of the ESC/char PF key assignments is based on the first two-and-one-half rows of alphanumeric keys being treated as a matrix, thus:

row 1 (1 - 0) = PF1 - PF10
 row 2 (Q - P) = PF11 - PF20
 row 3 (A - F) = PF21 - PF24

Similarly, the PA key assignments have, as their second key, the first three characters of the fourth row of alpha keys (Z, X, C). Either lower-case or upper-case (shifted) alpha characters are valid.

4. The last character on the screen (the line-24, column-80 character position) cannot be displayed. This feature is designed to defeat the TeleVideo 910 Auto-Scroll capability.

3278 Function	Key Sequence	Hex Value Generated
Reset	CTRL/R	12H
Backspace Cursor	← or BACKSPACE	08H
Down Cursor	↓ or LINE FEED	0AH
Up Cursor	↑	0BH
Forward Space Cursor	→	0CH
Home	HOME	1EH
Tab	TAB	09H
Back Tab	CTRL/B	02H
Delete	DEL	7FH
New Line	CTRL/N	0EH
Duplicate	CTRL/D	04H
Field Mark	CTRL/F	06H
Insert Mode	CTRL/U	15H
Erase to End of Field	CTRL/E	05H
Erase Input	CTRL/X	18H
Enter	RETURN or ENTER	0DH
Clear	CLEAR/SPACE	1AH
Sys Request	ESC ?	1B 3FH
PF1	ESC/1 or FUNCT/1	1B 31H 01 31 0DH
PF2	ESC/2 or FUNCT/2	1B 32H 01 32 0DH
PF3	ESC/3 or FUNCT/3	1B 33H 01 33 0DH
PF4	ESC/4 or FUNCT/4	1B 34H 01 34 0DH
PF5	ESC/5 or FUNCT/5	1B 35H 01 35 0DH
PF6	ESC/6 or FUNCT/6	1B 36H 01 36 0DH

A/C-4 (B)

3278 Function	Key Sequence	Hex Value Generated
PF7	ESC/7 or FUNCT/7	1B 37H 01 37 0DH
PF8	ESC/8 or FUNCT/8	1B 38H 01 38 0DH
PF9	ESC/9 or FUNCT/9	1B 39H 01 39 0DH
PF10	ESC/0 or FUNCT/0	1B 30H 01 30 0DH
PF11	ESC/Q	1B 51H
PF12	ESC/W	1B 57H
PF13	ESC/E	1B 45H
PF14	ESC/R	1B 52H
PF15	ESC/T	1B 54H
PF16	ESC/Y	1B 59H
PF17	ESC/U	1B 55H
PF18	ESC/I	1B 49H
PF19	ESC/O	1B 4FH
PF20	ESC/P	1B 50H
PF21	ESC/A	1B 41H
PF22	ESC/S	1B 53H
PF23	ESC/D	1B 44H
PF24	ESC/F	1B 46H
PA1	ESC Z	1B 5AH
PA2	ESC X	1B 58H
PA3	ESC C	1B 43H
Print	CTRL/P	10H
Cursor Select	CTRL/C	03H
Attention	ESC \	1B 5CH
Device Cancel	ESC]	1B 5DH
Ident	ESC :	1B 3AH
Test	ESC ;	1B 3BH
Special Function	Key Sequence	Hex Value Generated
Numeric Override	ESC [1B 5BH
Refresh Screen	CTRL/W	17H
Initialize Terminal	ESC <	1B 3CH
Display Status Line	ESC _ (underline)	1B 5FH

G.37 TV910P Terminal Module—Televideo TV910+/912

To set up the TeleVideo 910+/912 terminal for connection to the A/C-4 (B) in order to emulate the 3278, proceed as follows:

1. Disconnect the AC power cord from the outlet before opening the TeleVideo terminal case.
2. This section describes how to set the terminal switches on the TeleVideo 910+/912 terminals. Although these two terminals use the same software driver, their switch settings vary. The 910+ switch settings will be covered first, followed by the settings of the 912.

910+ S1 (right rear)	Set to:	Comments																																								
1 - 4	—	<table border="0" style="width: 100%;"> <thead> <tr> <th style="text-align: left;">Baud Rate</th> <th style="text-align: left;">1</th> <th style="text-align: left;">2</th> <th style="text-align: left;">3</th> <th style="text-align: left;">4</th> </tr> </thead> <tbody> <tr> <td>110</td> <td>DOWN</td> <td>DOWN</td> <td>UP</td> <td>UP</td> </tr> <tr> <td>300</td> <td>DOWN</td> <td>UP</td> <td>UP</td> <td>DOWN</td> </tr> <tr> <td>1200</td> <td>UP</td> <td>DOWN</td> <td>DOWN</td> <td>DOWN</td> </tr> <tr> <td>2400</td> <td>UP</td> <td>DOWN</td> <td>UP</td> <td>DOWN</td> </tr> <tr> <td>4800</td> <td>UP</td> <td>UP</td> <td>DOWN</td> <td>DOWN</td> </tr> <tr> <td>9600</td> <td>UP</td> <td>UP</td> <td>UP</td> <td>DOWN</td> </tr> <tr> <td>19200</td> <td>UP</td> <td>UP</td> <td>UP</td> <td>UP</td> </tr> </tbody> </table>	Baud Rate	1	2	3	4	110	DOWN	DOWN	UP	UP	300	DOWN	UP	UP	DOWN	1200	UP	DOWN	DOWN	DOWN	2400	UP	DOWN	UP	DOWN	4800	UP	UP	DOWN	DOWN	9600	UP	UP	UP	DOWN	19200	UP	UP	UP	UP
Baud Rate	1	2	3	4																																						
110	DOWN	DOWN	UP	UP																																						
300	DOWN	UP	UP	DOWN																																						
1200	UP	DOWN	DOWN	DOWN																																						
2400	UP	DOWN	UP	DOWN																																						
4800	UP	UP	DOWN	DOWN																																						
9600	UP	UP	UP	DOWN																																						
19200	UP	UP	UP	UP																																						
5	DOWN	8 data bits																																								
6	as desired	UP = Send parity, DOWN = No parity (Set to match the converter)																																								
7	as desired	UP = EVEN parity, DOWN = ODD parity (Set to match A/C-4 (B))																																								
8	DOWN 1	stop bit (if baud rate is 110, set UP for 2 stop bits)																																								
9	DOWN	Auto wrap of																																								
10	DOWN	Auto Linefeed off																																								
910+ S2 (left rear)	Set to:	Comments																																								
1	DOWN	Sets Conversational Mode																																								
2	DOWN	Sets Full Duplex																																								
3	as desired	DOWN = 50 Hz (international) UP = 60 Hz (U.S.)																																								
4	DOWN	Sets Edit Mode to Duplex																																								
5	as desired	UP = Underline cursor DOWN = Block cursor																																								
6	UP	Sets 912/920 compatible																																								
7	as desired	UP = Green on black DOWN = Black on green																																								
8	UP	No DSR																																								
9	DOWN	DCD connected																																								
10	DOWN	DTR on with terminal																																								

912 S1/S3 Switches

The S1 switches on the back panel switches are used to set the baud rate for communication with the A/C-4 (B). The S3 switches are used to set the Printer Port baud rate. Set one of the following S1 and S3 group switches DOWN for the desired terminal baud rate:

S1/S3 Switches	Desired Baud Rate
2	9600
3	4800
4	2400
5	200
6	600
7	300
10	110

912 S2 (left rear)	Set to:	Comments
1	UP	Not used
2	DOWN	Set Standard Character Set
3	UP	Full Duplex
4	as desired	UP = 50 Hz (foreign) DOWN = 60 Hz (U.S.)
5	as desired	UP = No Parity DOWN = Send Parity
6	DOWN	Sets 1 Stop Bit (Note: terminal automatically sets 2 Stop Bits if baud rate is set to 110 bps)
7	UP	8 Data Bits are defined
8	UP	Only necessary for Rev. E and lower
9	as desired	Set for desired parity: UP = EVEN DOWN = ODD
10	as desired	UP = Steady cursor DOWN = Blinking cursor (Rev. E and lower uses jumper W25)

912 S5 Switches

To set the S5 switches, you must remove the terminal cover. The S5 group is near the back edge of the circuit board and is labeled S.

S5	Set to:	Comments
1	UP	DSR disconnected
2	DOWN	DCD connected
3	OPEN	Used in conjunction with Switch 4
4	DOWN	DTR connected
5	NOT USED	No auxiliary printer support
6 - 7	DOWN	RS-232C

3. Jumper (S4/W33) must be installed on the main circuit board to DISABLE the Auto New Line at column 80.

4. Replace the cover, reconnect the AC power cord and connect the terminal to the A/C-4 (B) port (or modem, etc.), as appropriate.

Keyboard Emulation

Following is a table showing how the TeleVideo 910+ keyboard is used in emulation of the 3278 keyboard.

NOTES:

1. Press <Ctrl> concurrently with the indicated key.
2. Press <Esc> prior to pressing the indicated key.
3. The second character of the FUNCT/char PF key assignments is based on the first two-and-one-half rows of alphanumeric keys being treated as a matrix, thus:

row 1 (1 - 0) = PF1 - PF10
 row 2 (Q - P) = PF11 - PF20
 row 3 (A - F) = PF21 - PF24

Either lower-case or upper case (shifted) alpha-characters are valid.

4. The last character on the screen (the line-24, column-80 character position) cannot be displayed. This feature is designed to defeat the TeleVideo 910+/912 Auto-Scroll capability.

3278 Function	Key Sequence	Hex Value Generated
Reset	CTRL/R	12H
Backspace Cursor	← or BACKSPACE	08H
Down Cursor	↓ or LINE FEED or CTRL/V	0AH 16H
Up Cursor	↑	0BH
Forward Space Cursor	→	0CH
Home	HOME	1EH
Tab	TAB	09H
Back Tab	BACK TAB	1B 49H
Delete	DEL	7FH
New Line	CTRL/N	0EH
Duplicate	CTRL/D	04H
Field Mark	CTRL/F	06H
Insert Mode	CTRL/U	15H
Erase to End of Field	CTRL/E	05H
Erase Input	CTRL/X	18H
Enter	RETURN or ENTER	0DH
Clear	CLEAR/SPACE	1AH
Sys Request	ESC ?	1B 3FH
PF1	FUNCT/1	01 31 0DH
PF2	FUNCT/2	01 32 0DH
PF3	FUNCT/3	01 33 0DH
PF4	FUNCT/4	01 34 0DH
PF5	FUNCT/5	01 35 0DH
PF6	FUNCT/6	01 36 0DH
PF7	FUNCT/7	01 37 0DH
PF8	FUNCT/8	01 38 0DH
PF9	FUNCT/9	01 39 0DH
PF10	FUNCT/0	01 30 0DH
PF11	FUNCT/Q	01 51 0DH
PF12	FUNCT/W	01 57 0DH

A/C-4 (B)

3278 Function	Key Sequence	Hex Value Generated
PF13	FUNCT/E	01 45 0DH
PF14	FUNCT/R	01 52 0DH
PF15	FUNCT/T	01 54 0DH
PF16	FUNCT/Y	01 59 0DH
PF17	FUNCT/U	01 55 0DH
PF18	FUNCT/I	01 49 0DH
PF19	FUNCT/O	01 4F 0DH
PF20	FUNCT/P	01 50 0DH
PF21	FUNCT/A	01 41 0DH
PF22	FUNCT/S	01 53 0DH
PF23	FUNCT/D	01 44 0DH
PF24	FUNCT/F	01 46 0DH
PA1	ESC 1	1B 31H
PA2	ESC 2	1B 32H
PA3	ESC 3	1B 33H
Print	CTRL/P	10H
Cursor Select	CTRL/C	03H
Attention	ESC \	1B 5CH
Device Cancel	ESC]	1B 5DH
Ident	ESC :	1B 3AH
Test	ESC ;	1B 3BH
Special Function	Key Sequence	Hex Value Generated
Numeric Override	ESC [1B 5BH
Refresh Screen	CTRL/W	17H
Initialize Terminal	ESC <	1B 3CH
Display Status Line	ESC _ (underline)	1B 5FH

G.38 TV925 Terminal Module—TeleVideo TV920/925/950

To set up the TeleVideo 920/925/950 terminal for connection to the A/C-4 (B) in order to emulate the 3278, proceed as follows:

1. Disconnect the AC power cord from the outlet before opening the TeleVideo 920 case.
2. This section describes how to set the terminal switches on the TeleVideo 920/925/950 terminals. Although these three terminals use the software driver, their switch settings vary. Switches on the Televideo 920 are identical to those of the TeleVideo 912. Refer to the previous section (TV910P) for the settings of the TeleVideo 920 option switches.

NOTE:

Both the 925 and 950 have a Setup Mode available to you for setting some of the terminals' options. All of these options are set either by the terminals' switches or by the A/C-4 (B) initialization procedure. You should be very careful because the use of Setup Mode may therefore be detrimental to operation of the terminal or the A/C-4 (B).

S1 (Right Rear)	Set to:	Comments
1 - 4	—	Sets the baud rate of the main port
5	DOWN	Sets 8-bit word
6	DOWN	Sets 1 stop bit (set 2 stop bits for 110 bps)
7 - 10		Sets the baud rate of the printer port

925 Baud Rates	Switches			
	1/7	2/8	3/9	4/10
110	DOWN	DOWN	UP	UP
300	DOWN	UP	UP	DOWN
1200	UP	DOWN	DOWN	DOWN
2400	UP	DOWN	UP	DOWN
4800	UP	UP	DOWN	DOWN
9600	UP	UP	UP	DOWN
9600	DOWN	DOWN	DOWN	DOWN
19200	UP	UP	UP	UP

950 Baud Rates	Switches			
	1/7	2/8	3/9	4/10
110	UP	UP	DOWN	DOWN
300	DOWN	UP	UP	DOWN
1200	DOWN	DOWN	DOWN	UP
2400	DOWN	UP	DOWN	UP
4800	DOWN	DOWN	UP	UP
9600	DOWN	UP	UP	UP
9600	DOWN	DOWN	DOWN	DOWN
19200	UP	UP	UP	UP

A/C-4 (B)

S2 (Left Rear)	Set to:	Comments
1	925: DOWN 950: UP	Set to Duplex edit mode
2	DOWN	925: Non-912/920 emulation 950: Cursor display steady
3, 4, 5	No Parity Odd Parity Even Parity Mark Parity Space Parity	3=DOWN 4=DOWN 5=DOWN 3=DOWN 4=DOWN 5=UP 3=DOWN 4=UP 5=UP 3=UP 4=DOWN 5=UP 3=UP 4=UP 5=UP
6	UP	Set normal block characters on a black screen
7, 8	925: UP, DOWN 950: DOWN, UP	Full-duplex transmission
9	as desired	DOWN = 50 Hz, UP = 60Hz
10	925: DOWN 950: ?	No auto Linefeed UP = Key Click OFF DOWN = Key Click ON

925 S3 Switches

On the 925 only, there are 10 toggle-type switches that are only accessible by removing the terminal cover. They are labeled as S3 switches and should be set to the following values:

S3 Switches	Set to:	Comments
1	as desired	UP = Key click OFF DOWN = Key click ON
2	DOWN	Set the language to ENGLISH
3	DOWN	
4	as desired	DOWN = Blinking cursor UP = Steady cursor
5	as desired	DOWN = Block cursor UP = Underline cursor
6	DOWN	Timeout blank option disabled
7	UP	Page Attributes function enabled Line Attributes function disabled
8	DOWN	DCD Connected
9	UP	DSR Disconnected
10	DOWN	DTR Connected

3. Replace the cover, reconnect the AC power cord, connect the terminal to the A/C-4 (B) port (or modem, etc.), as appropriate.

Keyboard Emulation

Following is a table showing how the TeleVideo 920/925/950 keyboards are used in emulation of the 3278 keyboard.

NOTES:

1. Press <Ctrl>, <Shift>, or <Funct> key concurrently with the indicated key (alpha characters may be lower or upper case).
2. Press <Esc> followed by the indicated character.
3. The Cursor Down key for the TeleVideo 920 is slightly different from that of the TeleVideo 925/950. On the TeleVideo 920, Cursor Down key sequence is CTRL/V.
4. The last character on the screen (the line-24, column-80 character position) cannot be displayed. This feature is designed to defeat the TeleVideo Auto-Scroll capability.

3278 Function	Key Sequence	Hex Value Generated
Reset	CTRL/R	12H
Backspace Cursor	← or BACKSPACE	08H
Down Cursor	↓	16H
Up Cursor	↑	0BH
Forward Space Cursor	→	0CH
Home	HOME	1EH
Tab	TAB	09H
Back Tab	BACK TAB	1B 49H
Delete	CHAR DELETE or DEL	1B 57H 7FH
New Line	LINE FEED	0AH
Duplicate	CTRL/D	04H
Field Mark	CTRL/F	06H
Insert Mode	CHAR INSERT or LINE INSERT	1B 51H 1B 45H
Erase to End of Field	LINE DELETE	1B 52H
Erase Input	LINE ERASE	1B 54H
Enter	RETURN or ENTER	0DH
Clear	PAGE ERASE or CLEAR SPACE	1B 59H 1AH
Sys Request	ESC ?	1B 3FH
PF1	F1	01 40 0DH
PF2	F2	01 41 0DH
PF3	F3	01 42 0DH
PF4	F4	01 43 0DH
PF5	F5	01 44 0DH
PF6	F6	01 45 0DH
PF7	F7	01 46 0DH
PF8	F8	01 47 0DH
PF9	F9	01 48 0DH
PF10	F10	01 49 0DH
PF11	SHIFT/F1 or F11	01 60 0DH 01 4A 0DH
PF12	SHIFT/F2	01 61 0DH
PF13	SHIFT/F3	01 62 0DH
PF14	SHIFT/F4	01 63 0DH

3278 Function	Key Sequence	Hex Value Generated
PF15	SHIFT/F5	01 64 0DH
PF16	SHIFT/F6	01 65 0DH
PF17	SHIFT/F7	01 66 0DH
PF18	SHIFT/F8	01 67 0DH
PF19	SHIFT/F9	01 68 0DH
PF20	SHIFT/F10	01 69 0DH
PF21	FUNCT/1	01 31 0DH
PF22	FUNCT/2	01 32 0DH
PF23	FUNCT/3	01 33 0DH
PF24	FUNCT/4	01 34 0DH
PA1	ESC 1	1B 31H
PA2	ESC 2	1B 32H
PA3	ESC 3	1B 33H
Print	CTRL/P	10H
Cursor Select	CTRL/C	03H
Attention	ESC \	1B 5CH
Device Cancel	ESC]	1B 5DH
Ident	ESC :	1B 3AH
Test	ESC ;	1B 3BH
Special Function	Key Sequence	Hex Value Generated
Numeric Override	ESC [1B 5BH
Refresh Screen	CTRL/W	17H
Initialize Terminal	ESC <	1B 3CH
Display Status Line	ESC _ (underline)	1B 5FH

G.39 TV970 Terminal Module—TeleVideo TV970

To set up the TeleVideo TV-970 terminal for connection to the A/C-4 (B) in order to emulate the 3278, proceed as follows.

All operator-selectable parameters are input from the keyboard through the TV-970 setup mode; there are no external switches.

1. Connect the terminal to the A/C-4 (B) port (modem or direct cable) as appropriate.
2. To enter Setup mode, press the SETUP key. A Setup Menu will appear on the terminal's screen. To exit Setup mode, press the SETUP key a second time. To permanently save the reset parameter values (as opposed to allowing them to revert to previous values following the current session), enter a CTRL/S before exiting the Setup mode. Set the terminal's parameters as follows:

Identifier	Value	Comments
COMM	CNV	Conversational mode
DUPLX	FDX	Full Duplex communication
SEND/RCV	NO ECHO	Local terminal echo turned off
BAUD (MAIN)	as desired	Main port baud rate
PARITY (MAIN)	as desired	Main port parity
DATA BITS (MAIN)	as desired	Main port word size
STOP BIT (MAIN)	as desired	Main port stop bit(s)
RCV CTRL	as desired	Set to match logical flow control selection configured for the A/C-4 (B) port
XMIT CTRL (MAIN)	as desired	Set to match logical flow control selection configured for the A/C-4 (B) port
BAUD (PRINT)	as desired	Printer port baud rate
PARITY (PRINT)	as desired	Printer port parity
DATA BITS (PRINTER)	as desired	Printer port word size
STOP BIT (PRINTER)	as desired	Printer port stop bit(s)
XMITCTRL (PRINT)	as desired	Set to match logical flow control selection configured for the printer being used
PRINT STAT	BUF/XPT	Buffered transparent print selected
INS CHAR	n.a.	The character which replaces erased data on the screen (three-character decimal value)
INS/RPL	n.a.	Insert overwrites/moves current data
CTRL REP	PROC	Terminal processes commands received from the host
AUTOPG	n.a.	Screen pages/scrolls when cursor goes beyond 24th line
AUTOWRAP	NO WRAP	Autowrap disabled
EDIT BOUND	n.a.	Screen/page editing capability
EDITING EXT	DSPL	Permits insert/delete to affect full screen
HORZ EDIT	n.a.	Insert/delete commands affect data to
		of cursor
VERT EDIT	n.a.	Insert/delete commands affect data above/below cursor line
AUTOTAB	n.a.	Cursor moves/does not move into a guarded area
GUARDED XFER	ALL	All areas are transmitted and printed as they are displayed
MULTI-AREA XFER	ALL	Allows all unguarded fields to be transmitted

Identifier	Value	Comments
XFER TERM	FULL	Defines the data to be transferred as entire page of memory
LN XFER	PG	Transmits through cursor or end-of-page
XFER EXEC	DEFER	SEND key transmit sequence
PG XFER	PG	Allows entire page to be transmitted
CHAR/LN	132	Allows terminal to display lines of length 132 characters
LN/PG	24	Defines terminal page length as 24 lines
SCRN BACK	as desired	Display of light on dark or dark on light
SCRN SAVER	as desired	Screen turns off after n minutes if idle
CROLL	as desired	Rate of terminal data display
25TH LINE	as desired	Use of 25th line; blank, status, or message
1ST CHAR SET U.S.	U.S.	ASCII (only setting)
2ND CHAR SET U.K.	U.K.	ASCII (only setting)
LF/NEW LN	LN FEED	LINE FEED key generates only LF (= 0AH), RETURN generates only CR (=0DH)
CURSOR STYLE	as desired	Manner of cursor display
NORMAL ATTR	HIGH	Normal intensity is defined to be the higher of the two intensities
LN ATTR	NOR	Single-height, single-width character display
POWER/HZ	as desired	50 Hz or 60 Hz
KEYCLICK	as desired	Audible or Inaudible
BREAK KEY	IGNORE	BREAK key is ignored when pressed

Keyboard Emulation

Following is a table showing how the TeleVideo TV-970 keyboard is used in emulation of the 3278 keyboard.

NOTES:

- 1.Press <Ctrl> concurrently with the indicated key.
- 2.Press <Esc> prior to pressing the indicated key

3278 Function	Key Sequence	Hex Value Generated
Reset	CTRL/R	12H
Backspace Cursor	←	1B 5B 44H
Down Cursor	↓	1B 5B 42H
Up Cursor	↑	1B 5B 41H
Forward Space Cursor	→	1B 5B 43H
Home	HOME	1B 5B 48H
Tab	TAB	09H
Back Tab	BACKTAB	1B 5B 5AH
Delete	DEL or CHAR DELETE	7FH 1B 5B 50H
New Line	LINE INSERT	1B 5B 4CH
Duplicate	CTRL/D	04H
Field Mark	CRTL/F	06H
Insert Mode	CHAR INSERT	1B 5B 40H
Erase to End of Field	LINE ERASE	1B 5B 4BH
Erase Input	PAGE ERASE	1B 5B 4AH

3278 Function	Key Sequence	Hex Value Generated
Enter	RETURN	0DH
Clear	LINE DELETE	1B 5B 4DH
Sys Request	ESC S	1B 53H
PF1	F1	1B 3F 61H
PF2	F2	1B 3F 62H
PF3	F3	1B 3F 63H
PF4	F4	1B 3F 64H
PF5	F5	1B 3F 65H
PF6	F6	1B 3F 66H
PF7	F7	1B 3F 67H
PF8	F8	1B 3F 68H
PF9	F9	1B 3F 69H
PF10	F10	1B 3F 6AH
PF11	F11	1B 3F 6BH
PF12	F12	1B 3F 6CH
PF13	F13	1B 3F 6DH
PF14	F14	1B 3F 6EH
PF15	F15	1B 3F 6FH
PF16	F16	1B 3F 70H
PF17	SHIFT F7	1B 3F 47H
PF18	SHIFT F8	1B 3F 48H
PF19	SHIFT F9	1B 3F 49H
PF20	SHIFT F10	1B 3F 4AH
PF21	SHIFT F11	1B 3F 4BH
PF22	SHIFT F12	1B 3F 4CH
PF23	SHIFT F13	1B 3F 4DH
PF24	SHIFT F14	1B 3F 4EH
PA1	SHIFT F1	1B 3F 41H
PA2	SHIFT F2	1B 3F 42H
PA3	SHIFT F3	1B 3F 43H
Print	PRINT	1B 5B 69H
Cursor Select	CTRL/C	03H
Attention	ESC \	1B 5CH
Device Cancel	ESC]	1B 5DH
Ident	ESC :	1B 3AH
Test	ESC ;	1B 3BH
Special Function	Key Sequence	Hex Value Generated
Numeric Override	ESC {	1B 7BH
Refresh Screen	CTRL W	17H
Initialize Terminal	ESC <	1B 3CH
Display Status Line	ESC _ (underline)	1B 5FH

G.40 VIEWC Terminal Module—ADDS Viewpoint/Color

To set up the ADDS® Viewpoint®/Color terminal for connection to the A/C-4 (B) in order to emulate the 3278, proceed as follows.

All operator-selectable variables are input from the keyboard into the Status Line in the Viewpoint/Color Setup Mode; there are no external switches.

1. Connect the terminal to the A/C-4 (B) port (modem or direct cable) as appropriate.
2. For details on how to enter and exit the Viewpoint/Color Setup mode, and how to select the various options, please refer to the Viewpoint/Color User's Manual. There are four banks of logical switches with eight bits per bank. Set the switches as follows:

Bank #1	Set to:	Comments	1, 5	2, 6	3, 7	4, 8	Baud Rate
1-4	as desired	EIA Port Baud	0	0	0	0	110
		See Table	0	0	1	0	300
			0	0	1	1	1200
5-8	as desired	Aux. Port Baud	0	1	0	1	2400
		See Table	0	1	1	0	4800
			0	1	1	1	9600
			1	0	0	0	19200

Bank #2	Set to:	Comments
1	1	Full Duplex
2	as desired	X-ON/X-OFF—set to match logical flow control selection configured for the A/C-4 (B) port
3	0	Disable 2nd page option
4	0	Auto Scroll disable
5	0	Auto Line Feed disable
6	as desired	Display Parity Error
7, 8	as desired	Parity 0, 0 = Odd 1, 0 = Mark 0, 1 = Even 1, 1 = Space

Bank #3	Set to:	Comments
1	as desired	Screen Refresh Rate 0 = 60 Hz, 1 = 50 Hz
2	as desired	0 = Cursor Visible 1 = Cursor Suppressed
3	Reserved	
4	as desired	0 = Flashing Cursor 1 = Steady Cursor
5, 6	0, 0	Upper/lower-case characters
7, 8	0, 0	CR as line terminator

Bank #4	Set to:	Comments
1	as desired	Extended Color Palette
2	1	Cursor home position at upper left
3	as desired	Audible Keyclick
4-6	as desired	Foreign Language character setting
7	0	Regent 40 mode disabled
8	as desired	CRT Auto Off

Keyboard Emulation

Following is a table showing how the Viewpoint/Color keyboard is used in emulation of the 3278 keyboard.

NOTES:

1. Press <Ctrl> concurrently with the indicated key.
2. Press <Esc> prior to pressing the indicated key.
3. The last character on the screen (the line-24, column-80 character position) cannot be displayed. This feature is designed to defeat the ADDS Auto-Scroll capability.
4. Because the ENTER key on the numeric keypad generates varying sequences (depending on the presence or absence of field attributes), it is our recommendation that this key not be used.

3278 Function	Key Sequence	Hex Value Generated
Reset	CTRL/R	12H
Backspace Cursor	← or BACKSPACE	15H 08H
Down Cursor	↓	0AH
Up Cursor	↑	1AH
Forward Space Cursor	→	06H
Home	HOME	01H
Tab	TAB	09H
Backtab	SHIFT/TAB	1B 4FH
Delete	DEL	7FH
New Line	INS L	1B 4DH
Duplicate	CTRL/D	04H
Field Mark	CTRL/O	0FH
Insert Mode	INS C	1B 46H
Erase to End of Field	CTRL/EOF	1B 4BH
Erase Input	CTRL/E ALL	1B 47H
Enter	RETURN	0DH
Clear	DEL L or CTRL/L	1B 6CH 0CH
Sys Request	ESC ?	1B 3FH
PF1	F1	02 31 0DH
PF2	F2	02 32 0DH
PF3	F3	02 33 0DH
PF4	F4	02 34 0DH
PF5	F5	02 35 0DH
PF6	F6	02 36 0DH
PF7	F7	02 37 0DH
PF8	F8	02 38 0DH

A/C-4 (B)

3278 Function	Key Sequence	Hex Value Generated
PF9	SHIFT/F1	02 21 0DH
PF10	SHIFT/F2	02 22 0DH
PF11	SHIFT/F3	02 23 0DH
PF12	SHIFT/F4	02 24 0DH
PF13	SHIFT/F5	02 25 0DH
PF14	SHIFT/F6	02 26 0DH
PF15	SHIFT/F7	02 27 0DH
PF16	SHIFT/F8	02 28 0DH
PF17	ESC 7	1B 37H
PF18	ESC 8	1B 38H
PF19	ESC 9	1B 39H
PF20	ESC 0	1B 30H
PF21	ESC 1	1B 31H
PF22	ESC 2	1B 32H
PF23	ESC 3	1B 33H
PF24	ESC 4	1B 34H
PA1	ESC ,	1B 2CH
PA2	ESC .	1B 2EH
PA3	ESC /	1B 2FH
Print	CTRL/P	10H
Cursor Select	CTRL/C	03H
Attention	ESC \	1B 5CH
Device Cancel	ESC]	1B 5DH
Ident	ESC :	1B 3AH
Test	ESC ;	1B 3BH
Special Function	Key Sequence	Hex Value Generated
Numeric Override	ESC [1B 5BH
Refresh Screen	CTRL/W	17H
Initialize Terminal	ESC <	1B 3CH
Display Status Line	ESC _ (underline)	1B 5FH

G.41 VIEWP Terminal Module—ADDS Viewpoint/Regent

To set up the ADDS Viewpoint terminal for connection to the A/C-4 (B) in order to emulate the 3278, proceed as follows.

1. Disconnect the AC power cord before removing the cover of the terminal.
2. There are 8 option switches on the right rear of the terminal. Set them as follows:

S1 (right rear)	Set to:	Comments																																
1 - 3	?	<table border="1"> <thead> <tr> <th>Baud Rate</th> <th>S1-1</th> <th>S1-2</th> <th>S1-3</th> </tr> </thead> <tr> <td>110</td> <td>0</td> <td>0</td> <td>0</td> </tr> <tr> <td>300</td> <td>0</td> <td>1</td> <td>0</td> </tr> <tr> <td>1200</td> <td>0</td> <td>1</td> <td>1</td> </tr> <tr> <td>2400</td> <td>1</td> <td>0</td> <td>0</td> </tr> <tr> <td>4800</td> <td>1</td> <td>0</td> <td>1</td> </tr> <tr> <td>9600</td> <td>1</td> <td>1</td> <td>0</td> </tr> <tr> <td>19200</td> <td>1</td> <td>1</td> <td>1</td> </tr> </table>	Baud Rate	S1-1	S1-2	S1-3	110	0	0	0	300	0	1	0	1200	0	1	1	2400	1	0	0	4800	1	0	1	9600	1	1	0	19200	1	1	1
Baud Rate	S1-1	S1-2	S1-3																															
110	0	0	0																															
300	0	1	0																															
1200	0	1	1																															
2400	1	0	0																															
4800	1	0	1																															
9600	1	1	0																															
19200	1	1	1																															
4	0	Auto scroll disabled																																
5	0	Auto line feed disabled																																
6	1	Full duplex																																
7, 8	?	<table border="1"> <thead> <tr> <th>Parity</th> <th>7</th> <th>8</th> </tr> </thead> <tr> <td>ODD</td> <td>0</td> <td>0</td> </tr> <tr> <td>EVEN</td> <td>0</td> <td>1</td> </tr> <tr> <td>MARK</td> <td>1</td> <td>0</td> </tr> <tr> <td>SPACE</td> <td>1</td> <td>1</td> </tr> </table>	Parity	7	8	ODD	0	0	EVEN	0	1	MARK	1	0	SPACE	1	1																	
Parity	7	8																																
ODD	0	0																																
EVEN	0	1																																
MARK	1	0																																
SPACE	1	1																																

3. There are 8 option switches located inside the Viewpoint on the main printed circuit board. The cover must be removed to set them. The switch group is labeled as S2 and is a few inches up from and to the right of the RS-232C connectors.

S2 (internal)	Set to:	Comments
1	?	0 = White on black 1 = Black on white
2	0	Disable parity error display
3	?	0 = 60 Hz, 1 = 50 Hz
4, 5, 6	0	U. S. character set
7	?	0 = Steady cursor 1 = Blinking cursor
8	?	0 = Block cursor 1 = Underline cursor

4. Replace the cover, reconnect the AC power cord, and connect the terminal to the A/C-4 (B) port (or modem, etc.) as appropriate.

To set up the ADDS Regent 20 or 25 terminal for connection to the A/C-4 (B) in order to emulate the 3278, proceed as follows.

1. Disconnect the AC power cord before removing the rear plate of the terminal.
2. The Regent 20 and 25 have one switch block with eight switches on the right rear of the terminal. Set the option switches as follows.

A/C-4 (B)

Switch (right rear)	Set to:	Comments
S1	?	0 = White on black 1 = Black on white
S2	1	Full duplex
S3, S4	?	Parity 3 4 ODD 0 0 EVEN 0 1 MARK 1 0 SPACE 1 1
S5	0	Auto line feed disabled
S6 - S8	?	Baud Rate S6 S7 S8 110 0 0 0 300 0 1 0 1200 0 1 1 2400 1 0 1 4800 1 1 0 9600 1 1 1

3. There are two switch blocks (A3 and A5) with eight option switches located inside on a pull-out printed circuit board. The rear-panel plate must be removed and the board pulled out to set them.

A3 (PC Board)	Set to:	Comments
S1	0	Reserved
S2	0	Parity check disabled
S3	?	0 = Steady cursor 1 = Blinking cursor
S4	0	Keyboard lock off (ESC, 5 locks; ESC, 6 unlocks)
S5 - S7	0	U. S. character set
S8	?	0 = Upper, shift lower 1 = Lower, shift upper

A5 (PC Board)	Set to:	Comments
S1	0	Auto scroll disabled
S2	?	0 = 60 Hz, 1 = 50 Hz
S3	?	0 = No audible key feedback 1 = Audible key feedback
S4	?	0 = Block cursor 1 = Underline cursor
S5 - S8	0	Reserved

4. Replace the rear panel plate, reconnect the AC power cord, and connect the terminal to the A/C-4 (B) port (or modem, etc.) as appropriate.

To set up the ADDS Regent 40 or 60 terminal for connection to the A/C-4 (B) in order to emulate the 3278, proceed as follows.

1. Disconnect the AC power cord before removing the rear plate of the terminal.
2. The Regent 40 and 60 have two switch blocks (A and B) with eight switches each on the right rear of the terminal. Set the option switches as follows.

Switch A (right rear)	Set to:	Comments
S1	?	0 = Block cursor 1 = Underline cursor
S2	1	Full duplex
S3, S4	?	Parity 3 4 ODD 0 0 EVEN 0 1 MARK 1 0 SPACE 1 1
S5	?	0 = Steady cursor 1 = Blinking cursor
S6 - S8	?	Baud Rate S6 S7 S8 110 0 0 0 300 0 1 0 1200 0 1 1 2400 1 0 1 4800 1 1 0 9600 1 1 1

Switch B (right rear)	Set to:	Comments
S1, S2	0, 0	Line terminator character = CR
S3	0	Auto line feed disabled
S4	0	Auto scroll mode disabled
S5	0	RS-232C interface
S6	?	0 = White on black 1 = Black on white
S7, S8	?	Upper/Lower Case S7 S8 Upper, shift lower 0 0 Lower, shift upper 0 1 Upper case only 1 0

3. There is one switch block (D3) with eight option switches located inside on a pull-out printed circuit board. The rear panel plate must be removed and the board pulled out to set them.

A/C-4 (B)

D3 (PC Board)	Set to:	Comments
S1, S2	0	Reserved
S3	?	0 = 60 Hz, 1 = 50 Hz
S4	0	Reserved
S5	0	Reverse channel disabled
S6	0	Parity check disabled
S7	0	Line turnaround disabled
S8	0	Reserved

4. Replace the rear panel plate, reconnect the AC power cord and connect the terminal to the A/C-4 (B) port (or modem, etc.) as appropriate.

Keyboard Emulation

Following is a table showing how the ADDS Viewpoint keyboard is used in emulation of the 3278 keyboard.

NOTES:

1. Currently, the function keys available on some Regent terminals are not supported. This is so that one terminal driver may support both the Viewpoint and the Regent series. These function keys can be accommodated by using the User Defined Terminal Option.
2. Press <Ctrl> concurrently with the indicated key.
3. Press <Esc> prior to pressing the indicated key.
4. The second character of the ESC sequence PF key assignments is based on the first two-and-one-half rows of alphanumeric keys being treated as a matrix, thus:

row 1 (1 - 0) = PF1 - PF10
row 2 (Q - P) = PF11 - PF20
row 3 (A - F) = PF21 - PF24

Similarly, the PA key assignments have, as their second key, the first three characters on the fourth row of alpha keys (Z, X, C). Either lower-case or upper-case (shifted) alpha characters are valid.

5. The last character on the screen (the line-24, column-80 character position) cannot be displayed. This feature is designed to defeat the ADDS Viewpoint Auto-Scroll capability.

3278 Function	Key Sequence	Hex Value Generated
Reset	CTRL/R	12H
Backspace Cursor	← or BACKSPACE	15H 08H
Down Cursor	↓	0AH
Up Cursor	↑	1AH
Forward Space Cursor	→	06H
Home	HOME	01H
Tab	TAB	09H
Backtab	CTRL/K	0BH
Delete	DEL	7FH
New Line	CTRL/N	0EH
Duplicate	CTRL/D	04H
Field Mark	CTRL/O	0FH
Insert Mode	CTRL/Y	19H

3278 Function	Key Sequence	Hex Value Generated
Erase to End of Field	CTRL/E	05H
Erase Input	CTRL/X	18H
Enter	RETURN	0DH
Clear	ESC ^ or CTRL/L	1B 1EH 0CH
Sys Request	ESC ?	1B 3FH
PF1	ESC 1 or F1	1B 31H 02 31H
PF2	ESC 2 or F2	1B 32H 02 32H
PF3	ESC 3 or F3	1B 33H 02 33H
PF4	ESC 4	1B 34H
PF5	ESC 5	1B 35H
PF6	ESC 6	1B 36H
PF7	ESC 7	1B 37H
PF8	ESC 8	1B 38H
PF9	ESC 9	1B 39H
PF10	ESC 0	1B 30H
PF11	ESC Q	1B 51H
PF12	ESC W	1B 57H
PF13	ESC E	1B 45H
PF14	ESC R	1B 52H
PF15	ESC T	1B 54H
PF16	ESC Y	1B 59H
PF17	ESC U	1B 55H
PF18	ESC I	1B 49H
PF19	ESC O	1B 4FH
PF20	ESC P	1B 50H
PF21	ESC A	1B 41H
PF22	ESC S	1B 53H
PF23	ESC D	1B 44H
PF24	ESC F	1B 46H
PA1	ESC Z	1B 5AH
PA2	ESC X	1B 58H
PA3	ESC C	1B 43H
Print	CTRL/P	10H
Cursor Select	CTRL/C	03H
Attention	ESC \	1B 5CH
Device Cancel	ESC]	1B 5DH
Ident	ESC :	1B 3AH
Test	ESC ;	1B 3BH
Special Function	Key Sequence	Hex Value Generated
Numeric Override	ESC [1B 5BH
Refresh Screen	CTRL/W	17H
Initialize Terminal	ESC <	1B 3CH
Display Status Line	ESC _ (underline)	1B 5FH

G.42 VIP731 Terminal Module—Honeywell VIP 7301

To set up the Honeywell® VIP 7301 terminal for connection to the A/C-4 (B) in order to emulate the 3278, proceed as follows:

1. Disconnect the AC power cord from the outlet before setting the switches.
2. There is one group of ten switches located on the back panel of the terminal. Set the switches as follows:

S1 Switches	Set to:	Comments
1	DOWN	Normal Mode
2	(as required)	UP = Echo Mode DOWN = Non-Echo Mode Set by A/C-4 (B)
3	(as required)	UP = Roll Mode DOWN = Non-Roll Mode Set by A/C-4 (B)
4	n.a.	Applicable only when LOCAL key is pressed
5	as desired	UP = Even parity DOWN = Mark parity
6-8	as desired	Baud Rate (see chart below)
9	DOWN	VIP7200 Attribute commands accepted
10	as desired	UP = J1 pin 11 disabled DOWN = J1 pin 11 enable

Baud Rate	Switches		
	6	7	8
300	DOWN	DOWN	DOWN
1200	DOWN	UP	DOWN
2400	UP	DOWN	DOWN
4800	UP	DOWN	UP
9600	UP	UP	DOWN
19200	UP	UP	UP

3. There are two key switches on the keyboard which affect terminal operation; the LOCAL key must be UP to enable communication with A/C-4 (B), and the AUTO LF key must be UP so that the RETURN key generates only the CR character.
4. Reconnect the AC power cord and connect the terminal to the A/C-4 (B) port (or modem), as appropriate.

Keyboard Emulation

Following is a table showing how the Honeywell VIP 7301 keyboard is used in emulation of the 3278 keyboard.

NOTES:

1. Press <Ctrl> concurrently with the indicated key.
2. Press <Esc> prior to pressing the indicated key.

3278 Function	Key Sequence	Hex Value Generated
Reset	RESET	1B 65H
Backspace Cursor	← or BACKSPACE	1B 44H 08H
Down Cursor	↓	1B 42H
Up Cursor	↑	1B 41H
Forwardspace Cursor	→	1B 43H
Home	HOME	1B 48H
Tab	TAB	09H
Backtab	CTRL/TAB	1B 5B 5AH
Delete	DELETE	7FH
New Line	LF 0AH	
Duplicate	CTRL/D	04H
Field Mark	CTRL/F	06H
Insert Mode	CTRL/U	15H
Erase to End of Field	ERASE EOF	1B 4BH
Erase Input	ERASE EOP	1B 4AH
Enter	RETURN	0DH
Clear	CLEAR	1B 60H
Sys Request	CTRL/INIT	1B 63H
PF1	F1	1B 30H
PF2	F2	1B 32H
PF3	F3	1B 36H
PF4	F4	1B 38H
PF5	F5	1B 3AH
PF6	F6	1B 3CH
PF7	F7	1B 3EH
PF8	F8	1B 50H
PF9	F9	1B 52H
PF10	F10	1B 54H
PF11	F11	1B 5CH
PF12	F12	1B 5EH
PF13	F13 (SHIFT F1)	1B 31H
PF14	F14 (SHIFT F2)	1B 35H
PF15	F15 (SHIFT F3)	1B 37H
PF16	F16 (SHIFT F4)	1B 39H
PF17	F17 (SHIFT F5)	1B 3BH
PF18	F18 (SHIFT F6)	1B 3DH
PF19	F19 (SHIFT F7)	1B 3FH
PF20	F20 (SHIFT F8)	1B 51H
PF21	F21 (SHIFT F9)	1B 53H
PF22	F22 (SHIFT F10)	1B 56H
PF23	F23 (SHIFT F11)	1B 5DH
PF24	F24 (SHIFT F12)	1B 5FH
PA1	ESC F1	1B 1B 30H
PA2	ESC F2	1B 1B 32H
PA3	ESC F3	1B 1B 36H

A/C-4 (B)

3278 Function	Key Sequence	Hex Value Generated
Print	TRANSMIT	1B 69H
Cursor Select	CTRL/C	03H
Attention	ESC X	1B 58H
Device Cancel	ESC {	1B 7BH
Ident	ESC Y	1B 59H
Test	ESC Z	1B 5AH
Fast Forwardspace	CTRL/R	12H
Fast Backspace	CTRL/L	0CH
Special Function	Key Sequence	Hex Value Generated
Numeric Override	ESC #	1B 23H
Refresh Screen	CTRL/W	17H
Initialize Terminal	ESC }	1B 7DH
Display Status Line	ESC 3	1B 33H

G.43 VP60 Terminal Module—ADDS Viewpoint/60

To set up the ADDS Viewpoint/60 terminal for connection to the A/C-4 (B) in order to emulate the 3278, proceed as follows. All operator-selectable options are input from the keyboard into the Setup Mode Status Line; there are no external switches.

1. Connect the terminal to the A/C-4 (B) port (modem or direct cable) as appropriate.
2. Call up the Status Line by pressing <Shift> and <Home> simultaneously. A line containing four option banks of eight bits each will appear on the screen. Set the option values as follows:

Option Bank 1	Value	Comments
1 - 4	as desired	Main Port Baud Rate (see table below)
5 - 8	as desired	Auxiliary Port Baud Rate (see table below)

Baud Rate	Bit Settings			
	1/5	2/6	3/7	4/8
110	0	0	0	0
300	0	0	1	0
1200	0	0	1	1
2400	0	1	0	1
4800	0	1	1	0
9600	0	1	1	1
19200	1	0	0	0

Option Bank 2	Value	Comments															
1	1	Full Duplex															
2	as desired	0 = Dark Character on Light Screen 1 = Light Character on Dark Screen															
3 1	Video highlight at full intensity																
4 0	Auto Scroll disabled																
5 0	Auto Linefeed disabled																
6 0	Disable Parity Error Display																
7, 8	as desired	<table border="1"> <thead> <tr> <th>Parity</th> <th>7</th> <th>8</th> </tr> </thead> <tbody> <tr> <td>ODD</td> <td>0</td> <td>0</td> </tr> <tr> <td>EVEN</td> <td>0</td> <td>1</td> </tr> <tr> <td>MARK</td> <td>1</td> <td>0</td> </tr> <tr> <td>SPACE</td> <td>1</td> <td>1</td> </tr> </tbody> </table>	Parity	7	8	ODD	0	0	EVEN	0	1	MARK	1	0	SPACE	1	1
Parity	7	8															
ODD	0	0															
EVEN	0	1															
MARK	1	0															
SPACE	1	1															

Option Bank 3	Value	Comments
1	as desired	0 = 60 Hz, 1 = 50 Hz
2	0	Cursor visible
3	as desired	0 = Block, 1 = Underline Cursor
4	as desired	0 = Blink, 1 = Steady Cursor
5, 6	0,0	Upper/Lower-case characters
7, 8	0,0	Line terminator character CR selected

Option Bank 4	Value	Comments
1	Reserved	
2	1	Cursor home at upper left enabled
3	as desired	0 = Keyclick disabled 1 = enabled
4 - 6	Reserved	
7 0	Regent 40 mode disabled	
8	Reserved	

Keyboard Emulation

Following is a table showing how the ADDS Viewpoint/60 keyboard is used in emulation of the 3278 keyboard.

NOTES:

1. Press <Ctrl> concurrently with the indicated key.
2. Press <Esc> prior to pressing the indicated key.
3. The second character of the ESC sequence PF key assignments is based on the first two-and-one-half rows of alphanumeric keys being treated as a matrix, thus:

row 1 (1 - 0) = PF1 - PF10
row 2 (Q - P) = PF11 - PF20
row 3 (A - F) = PF21 - PF24

Similarly, the PA key assignments have, as their second key, the first three characters on the fourth row of alpha keys (Z, X, C). Either lower-case or upper-case (shifted) alpha characters are valid.

3278 Function	Key Sequence	Hex Value Generated
Reset	CTRL/R	12H
Backspace Cursor	← or BACKSPACE	15H 08H
Down Cursor	↓	0AH
Up Cursor	↑	1AH
Forward Space Cursor	→	06H
Home	HOME	01H
Tab	TAB	09H
Backtab	CTRL/K	0BH
Delete	DEL	7FH
New Line	CTRL/N	0EH
Duplicate	CTRL/D	04H
Field Mark	CTRL/O	0FH
Insert Mode	CTRL/Y	19H
Erase to End of Field	CTRL/E	05H
Erase Input	CTRL/X	18H
Enter	RETURN	0DH
Clear	ESC ^ or CTRL/L	1B 1EH 0CH
Sys Request	ESC ?	1B 3FH
PF1	ESC 1 or F1	1B 31H 02 31H

3278 Function	Key Sequence	Hex Value Generated
PF2	ESC 2 or F2	1B 32H 02 32H
PF3	ESC 3 or F3	1B 33H 02 33H
PF4	ESC 4 or F4	1B 34H 02 34H
PF5	ESC 5 or F5	1B 35H 02 35H
PF6	ESC 6 or F6	1B 36H 02 36H
PF7	ESC 7 or F7	1B 37H 02 37H
PF8	ESC 8 or F8	1B 38H 02 38H
PF9	ESC 9	1B 39H
PF10	ESC 0	1B 30H
PF11	ESC Q	1B 51H
PF12	ESC W	1B 57H
PF13	ESC E	1B 45H
PF14	ESC R	1B 52H
PF15	ESC T	1B 54H
PF16	ESC Y	1B 59H
PF17	ESC U	1B 55H
PF18	ESC I	1B 49H
PF19	ESC O	1B 4FH
PF20	ESC P	1B 50H
PF21	ESC A	1B 41H
PF22	ESC S	1B 53H
PF23	ESC D	1B 44H
PF24	ESC F	1B 46H
PA1	ESC Z	1B 5AH
PA2	ESC X	1B 58H
PA3	ESC C	1B 43H
Print	CTRL/P	10H
Cursor Select	CTRL/C	03H
Attention	ESC \	1B 5CH
Device Cancel	ESC]	1B 5DH
Ident	ESC :	1B 3AH
Test	ESC ;	1B 3BH
Special Function	Key Sequence	Hex Value Generated
Numeric Override	ESC [1B 5BH
Refresh Screen	CTRL/W	17H
Initialize Terminal	ESC <	1B 3CH
Display Status Line	ESC _ (underline)	1B 5FH

G.44 VP78 Terminal Module—ADDS Viewpoint/78

To set up the ADDS Viewpoint/78 terminal for connection to the A/C-4 (B) in order to emulate the 3278, proceed as follows:

All operator-selectable options are input from the keyboard into the Setup Mode Status Line; there are no external switches.

1. Connect the terminal to the A/C-4 (B) port (modem or direct cable) as appropriate.
2. Call up the Status Line by pressing <Alt>, <Shift>, and <Backtab> simultaneously. A line containing four option banks of eight bits each will appear on the screen. Set the option values as follows:

Option Bank 1	Value	Comments
1 - 4	as desired	Main Port Baud Rate (see table below)
5 - 8	as desired	Auxiliary Port Baud Rate (see table below)

Bit Settings

Baud Rate	1/5	2/6	3/7	4/8
110	0	0	0	0
300	0	0	1	0
1200	0	0	1	1
2400	0	1	0	1
4800	0	1	1	0
9600	0	1	1	1
19200	1	0	0	0

Option Bank 2	Value	Comments
1	Reserved	
2	as desired	0 = dark character on light screen 1 = light character on dark screen
3	1	Video highlight at full intensity
4	0	Auto Scroll disabled
5	0	Auto Linefeed disabled
6	0	Disable Parity Error Display
7, 8	as desired	Parity 7 8 ODD 0 0 EVEN 0 1 MARK 1 0 SPACE 1 1

Option Bank 3	Value	Comments
1	as required	0 = 60 Hz, 1 = 50 Hz
2	0	Cursor visible
3	as desired	0 = Block, 1 = Underline Cursor
4	as desired	0 = Blink, 1 = Steady Cursor
5, 6	0, 0	Upper/lower case characters
7, 8	Reserved	

Option Bank 4	Value	Comments
1	Reserved	
2	1	Cursor home at upper left enabled
3	as desired	0 = Keyclick disabled 1 = enabled
4 - 8	Reserved	

Keyboard Emulation

Following is a table showing how the ADDS Viewpoint/78 keyboard is used in emulation of the 3278-2 keyboard.

NOTES:

1. Press <Alt> concurrently with the indicated key.
2. Press <Esc> prior to pressing the indicated key.
3. The IBM 3278 keyboard, because it is an EBCDIC terminal, does not provide an ESC key. The ADDS Viewpoint/78 provides as an ESC key the key immediately below the ATTN key at the left side of the keyboard.

3278 Function	Key Sequence	Hex Value Generated
Reset	ALT/R or RESET	12H 1B 40H
Backspace Cursor	←	1B 38H
or	←←	1B 60H
Down Cursor	↓	1B 5EH
Up Cursor	↑	1B 5CH
Forward Space Cursor	→	1B 62H
Home	HOME SYMBOL	1B 3DH
Tab	→I	1B 3AH
Backtab	I←	1B 3CH
Delete	DELETE CHAR SYMBOL	1B 5AH
New Line	NEW LINE SYMBOL	1B 3EH
Duplicate	DUP	1B 54H
Field Mark	FIELD MARK	1B 56H
Insert Mode	INSERT SYMBOL	1B 58H
Erase to End of Field	ERASE EOF	1B 4EH
Erase Input	ERASE INPUT	1B 4BH
Enter	ENTER	0DH
Clear	ALT/CURSOR SEL	1B 47H
Sys Request	SYS REQ	1B 45H
PF1	PF1	1B 20H
PF2	PF2	1B 21H
PF3	PF3	1B 22H
PF4	PF4	1B 23H
PF5	PF5	1B 24H
PF6	PF6	1B 25H
PF7	PF7	1B 26H
PF8	PF8	1B 27H
PF9	PF9	1B 28H
PF10	PF10	1B 29H
PF11	PF11	1B 2AH

3278 Function	Key Sequence	Hex Value Generated
PF12	PF12	1B 2BH
PF13	PF13	1B 2CH
PF14	PF14	1B 2DH
PF15	PF15	1B 2EH
PF16	PF16	1B 2FH
PF17	PF17	1B 30H
PF18	PF18	1B 31H
PF19	PF19	1B 32H
PF20	PF20	1B 33H
PF21	PF21	1B 34H
PF22	PF22	1B 35H
PF23	PF23	1B 36H
PF24	PF24	1B 37H
PA1	PA1	1B 55H
PA2	PA2	1B 57H
PA3	ALT/INSERT SYMBOL	1B 59H
Print	DISPLAY-PRINT SYMBOL	1B 50H
Cursor Select	CURSOR SEL	1B 46H
Attention	ATTENTION	1B 44H
Device Cancel	DEVICE CANCEL	1B 41H
Ident	IDENT	1B 51H
Test	TEST	1B 53H
Fast Forwardspace	ALT→	1B 63H
Fast Backspace	ALT←	1B 61H
Special Function	Key Sequence	Hex Value Generated
Numeric Override	ESC {	1B 7BH
Refresh Screen	ALT/W	17H
Initialize Terminal	ESC }	1B 7DH
Display Status Line	ESC _ (underline)	1B 5FH

G.45 VP78C Terminal Module—ADDS Viewpoint/78 Color

All operator-selectable options are input from the keyboard into the Setup Mode Menus; there are no external switches. Do the following to set up the terminal for use with the A/C-4 (B).

1. Connect the terminal to the A/C-4 (B) port (modem or direct cable) as appropriate.
2. Call up the Master Help Menu by pressing <Alt>, <Shift>, and <Backtab> simultaneously. Enter either the Parameter Menu or the Color Palette Menu by pressing key #1 or #2, respectively.

Parameter Menu	Set to:	Comments
Main Baud Rate	as desired	0 = 110 2 = 300 3 = 1200 5 = 2400 6 = 4800 7 = 9600 8 = 19200
Parity Type	as desired	0 = ODD 1 = EVEN 2 = Mark 3 = Space
Parity	Check Enable	Y/N
Case Map Language	as desired	0 = USA/UK/France 1 = Germany/Switzerland 2 = Spain/Port 3 = Sweden/Finland
Upper Case Default	as desired	Y/N
Key to Upper Case Only	as desired	Y/N
Key Click Enable	as desired	Y/N
Cursor Blink Enable	as desired	Y/N
Block Cursor	as desired	Y/N
Cursor Display	as desired	Y/N
Screen Saver	as desired	Y/N
Home to Top Left	Y	
Auto Scroll Enable	N	No Auto Scroll
Auto Line Feed Enable	N	No Auto Line Feed
Color Palette Menu	Set to:	Comments
@ Palette	G	@ Palette set to green on black
A Palette	R	A Palette set to red on black
P Palette	C	P Palette set to cyan on black
Q Palette	W	Q Palette set to white on black

NOTE:

The Palette colors defined above correspond to the IBM/3278 default colors. Other colors may be defined without adversely affecting the operation of the A/C-4 (B).

Keyboard Emulation

Following is a table showing how the ADDS Viewpoint/78 Color keyboard is used in emulation of the 3278 keyboard.

NOTES:

1. Press <Alt> concurrently with the indicated key.

2. Press <Esc> prior to pressing the indicated key.

3. The IBM 3278 keyboard, because it is an EBCDIC terminal, does not provide an ESC key. The Viewpoint/78 Color provides as an ESC key the key immediately below the ATTN key at the left side of the keyboard.

3278 Function	Key Sequence	Hex Value Generated
Reset	ALT/R or RESET	12H 1B 40H
Backspace Cursor	←	1B 38H
or	←	1B 60H
Down Cursor	↓	1B 5EH
Up Cursor	↑	1B 5CH
Forward Space Cursor	→	1B 62H
Home	HOME SYMBOL	1B 3DH
Tab	→I	1B 3AH
Backtab	I←	1B 3CH
Delete	DELETE CHAR SYMBOL	1B 5AH
New Line	NEW LINE SYMBOL	1B 3EH
Duplicate	DUP	1B 54H
Field Mark	FIELD MARK	1B 56H
Insert Mode	INSERT SYMBOL	1B 58H
Erase to End of Field	ERASE EOF	1B 4EH
Erase Input	ERASE INPUT	1B 4BH
Enter	ENTER	0DH
Clear	ALT/CURSOR SEL	1B 47H
Sys Request	SYS REQ	1B 45H
PF1	PF1	1B 20H
PF2	PF2	1B 21H
PF3	PF3	1B 22H
PF4	PF4	1B 23H
PF5	PF5	1B 24H
PF6	PF6	1B 25H
PF7	PF7	1B 26H
PF8	PF8	1B 27H
PF9	PF9	1B 28H
PF10	PF10	1B 29H
PF11	PF11	1B 2AH
PF12	PF12	1B 2BH
PF13	PF13	1B 2CH
PF14	PF14	1B 2DH
PF15	PF15	1B 2EH
PF16	PF16	1B 2FH
PF17	PF17	1B 30H
PF18	PF18	1B 31H

3278 Function	Key Sequence	Hex Value Generated
PF19	PF19	1B 32H
PF20	PF20	1B 33H
PF21	PF21	1B 34H
PF22	PF22	1B 35H
PF23	PF23	1B 36H
PF24	PF24	1B 37H
PA1	PA1	1B 55H
PA2	PA2	1B 57H
PA3	ALT/INSERT SYMBOL	1B 59H
Print	DISPLAY PRINT SYMBOL	1B 50H
Cursor Select	CURSOR SEL	1B 46H
Attention	ATTENTION	1B 44H
Device Cancel	DEVICE CANCEL	1B 41H
Ident	IDENT	1B 51H
Test	TEST	1B 53H
Fast Forwardspace	ALT →	1B 63H
Fast Backspace	ALT ←	1B 61H
Special Function	Key Sequence	Hex Value Generated
Numeric Override	ESC {	1B 7BH
Refresh Screen	ALT/W	17H
Initialize Terminal	ESC }	1B 7DH
Display Status Line	ESC _ (underline)	1B 5FH

G.46 VT100 Terminal Module—DEC VT100™/VT101™/VT125™

To set up the DEC™ VT100 terminal for connection to the A/C-4 (B) in order to emulate the 3278, proceed as follows:

1. Connect the terminal to the A/C-4(B) port (modem or direct cable) as appropriate.
2. Turn on the Power Switch and enable the Software option switches through the keyboard (SETUP B procedure). SETUP B mode may be entered only from SETUP A mode by pressing the SETUP key, then the 5 key of the main keyboard. This mode contains a series of software keys that tailor the terminal to your operating environment. The following values are recommended for the interface with the A/C-4 (B):

BYTE 1 SWITCHES

(Bit def. from left to right)

	Set to:	Comments
1 (SCROLL)	as desired	Jump or Smooth Scroll
2 (AUTO REPEAT)	1	Set auto repeat function enabled
3 (SCREEN)	as desired	0 = Dark background 1 = Light background
4 (CURSOR)	as desired	0 = Underline cursor 1 = Block cursor

BYTE 2 SWITCHES

(Bit def. from left to right)

	Set to:	Comments
1 (MARGIN BELL)	—	Enable this option, if desired (OFF=0, ON=1)
(KEYCLICK)	—	Enable this option, if desired (OFF=0, ON=1)
3 (ANSI/VT52)	1	Disable VT52 compatible mode Enable ANSI compatible mode
4 (AUTO XON/XOFF)	as desired	Set to match logical flow control selection configured for the A/C-4 (B) port

BYTE 3 SWITCHES

(Bit def. from left to right)

	Set to:	Comments
1 (# SWITCH)	0	Set to # character
2 (WRAP AROUND)	0	Disable automatic wrap-around feature
3 (NEW LINE)	0	Disable New Line function
4 (INTERFACE)	0	Should disable unless the Interface option is installed

BYTE 4 SWITCHES

(bit def. from left to right)

	Set to:	Comments
1 (PARITY SENSE)	—	This switch is appropriate only if Bit 2 (PARITY) is Set. If so, ODD PARITY=0 and EVEN PARITY=1.
2 (PARITY)	—	Set as desired (OFF=0, ON=1). If ON=1 is set, then the PARITY SENSE switch (Bit 1) must also be set to ODD or EVEN parity.
3 (BITS PER CHAR)	as desired	Set to match number of bits selected in A/C-4 (B) configuration
4 (POWER)	as desired	0 = 60 Hz 1 = 50 Hz

The SETUP B mode screen gives the facility for setting the appropriate terminal baud rate. Available baud rates for use with the A/C-4 (B) are: 110, 300, 1200, 2400, 4800, 9600, and 19.2 Kbps. Both the transmit baud rate (T SPEED) and receive baud rate (R SPEED) must be set to the same value. The baud rate specified here must match the baud rate for the port to which this terminal is connected. For a baud rate of 110 bps, the number of Stop bits must be 2.

Keyboard Emulation

Following is a table showing how the DEC VT100 keyboard is used in emulation of the 3278 keyboard.

NOTES:

- 1.Press <Ctrl> concurrently with the indicated key.
- 2.Press <Esc> prior to pressing the indicated key.
- 3.NK denotes that the indicated key is found in the numeric keypad at the lower right of the keyboard (the A/C-4 (B) sets the keypad to Alternate keypad mode). For VT100 terminals (and all look-alike terminals which comply with ANSI Standard 3.64) having no numeric keypad, a terminal driver (Terminal ID = ANSI) is provided.

3278 Function	Key Sequence	Hex Value Generated
Reset	CTRL/R	12H
Backspace Cursor	←	1B 5B 44H
Down Cursor	↓	1B 5B 42H
Up Cursor	↑	1B 5B 41H
Forward Space Cursor	→	1B 5B 43H
Home	NK 0	1B 4F 70H
Tab	TAB	09H
Back Tab	BACKSPACE	08H
Delete	DELETE	7FH
New Line	LINE FEED	0AH
Duplicate	NK 6	1B 4F 76H
Field Mark	NK ,	1B 4F 6CH
Insert Mode	NK .	1B 4F 6EH
Erase to End of Field	NK 4	1B 4F 74H
Erase Input	NK 7	1B 4F 77H
Enter	RETURN or ENTER	0DH 1B 4F 4DH
Clear	NK -	1B 4F 6DH
Sys Request	NK 9	1B 4F 79H

A/C-4 (B)

3278 Function	Key Sequence	Hex Value Generated
PF1	PF1 or ESC 1	1B 4F 50H 1B 31H
PF2	PF2 or ESC 2	1B 4F 51H 1B 32H
PF3	PF3 or ESC 3	1B 4F 52H 1B 33H
PF4	PF4 or ESC 4	1B 4F 53H 1B 34H
PF5	ESC 5	1B 35H
PF6	ESC 6	1B 36H
PF7	ESC 7	1B 37H
PF8	ESC 8	1B 38H
PF9	ESC 9	1B 39H
PF10	ESC 0	1B 30H
PF11	ESC ! or ESC -	1B 21H 1B 2DH
PF12	ESC @ or ESC =	1B 40H 1B 3DH
PF13	ESC #	1B 23H
PF14	ESC \$	1B 24H
PF15	ESC %	1B 25H
PF16	ESC ^	1B 5EH
PF17	ESC &	1B 26H
PF18	ESC *	1B 2AH
PF19	ESC (1B 28H
PF20	ESC)	1B 29H
PF21	ESC ESC 1	1B 1B 31H
PF22	ESC ESC 2	1B 1B 32H
PF23	ESC ESC 3	1B 1B 33H
PF24	ESC ESC 4	1B 1B 34H
PA1	NK 1	1B 4F 71H
PA2	NK 2	1B 4F 72H
PA3	NK 3	1B 4F 73H
Print	NK 8	1B 4F 78H
Cursor Select	NK 5	1B 4F 75H
Attention	ESC \	1B 5CH
Device Cancel	ESC]	1B 5DH
Ident	ESC :	1B 3AH
Test	ESC ;	1B 3BH

Special Function	Key Sequence	Hex Value Generated
Numeric Override	ESC {	1B 7BH
Refresh Screen	CTRL/W	17H
Initialize Terminal	ESC <	1B 3CH
Display Status Line	ESC _ (underline)	1B 5FH

G.47 VT102 Terminal Module—DEC VT102

To set up the DEC VT102™ terminal for connection to the AC-4 (B) in order to emulate the 3278, proceed as follows:

1. Connect the terminal to the A/C-4 (B) port (modem or direct cable) as appropriate.
2. Turn on the power switch and enable the Software option switches through the keyboard (SETUP B procedure). SETUP B mode may be entered only from SETUP A mode by pressing the SETUP key, then the 5 key of the main keyboard. This mode contains a series of software keys that tailor the terminal to your operating environment. The following values are recommended for the interface with the A/C-4 (B):

BYTE 1 SWITCHES

(Bit def. from left to right)

	Set to:	Comments
1 (SCROLL)	as desired	Jump or Smooth Scroll
2 (AUTO REPEAT)	1	Set auto repeat function enabled
3 (SCREEN)	as desired	0 = Dark background 1 = Light background
4 (CURSOR)	as desired	0 = Underline cursor
1 = Block cursor		

BYTE 2 SWITCHES

(Bit def. from left to right)

	Set to:	Comments
1 (MARGIN BELL)	—	Enable this option, if desired (OFF=0, ON=1)
(KEYCLICK)	—	Enable this option, if desired (OFF=0, ON=1)
3 (ANSI/VT52)	1	Disable VT52 compatible mode
		Enable ANSI compatible mode
4 (AUTO X-ON/X-OFF)	as desired	Set to match logical flow control selection configured

BYTE 3 SWITCHES

(Bit def. from left to right)

	Set to:	Comments
1 (# SWITCH)	0	Set to # character
2 (WRAP AROUND)	0	Disable automatic wrap-around feature
3 (NEW LINE)	0	Disable New Line function
4 (INTERFACE)	0	Should disable unless Interface option is installed

BYTE 4 SWITCHES

(bit def. from left to right)

	Set to:	Comments
1 (PARITY SENSE)	—	This switch is appropriate only if Bit 2 (PARITY) is set. If so, ODD PARITY=0 and EVEN PARITY=1
2 (PARITY)	—	Set as desired (OFF=0, ON=1). If ON=1 is set, then the PARITY SENSE switch (Bit 1) must also be set to ODD or EVEN parity.
3 (BITS PER CHAR)	as desired	Set to match number of bits selected in A/C-4 (B) configuration
4 (POWER)	as desired	0 = 60 Hz 1 = 50 Hz

The SETUP B mode screen gives the facility for setting the appropriate terminal baud rate. Available baud rates for use with A/C-4 (B) are: 110, 300, 1200, 2400, 4800, 9600 and 19.2 Kbps. Both the transmit baud rate (T SPEED) and receive baud rate (R SPEED) must be set to the same value. The baud rate specified here must match the baud rate for the port to which this terminal is connected. For a baud rate of 110 bps, the number of Stop bits must be 2.

Keyboard Emulation

Following is a table showing how the DEC VT102 keyboard is used in emulation of the 3278 keyboard.

NOTES:

1. Press <Ctrl> concurrently with the indicated key.
2. Press <Esc> prior to pressing the indicated key.
3. NK denotes that the indicated key is found in the numeric keypad at the lower right of the keyboard (the A/C-4 (B) sets the keypad to Alternate keypad mode).

3278 Function	Key Sequence	Hex Value Generated
Reset	CTRL/R	12H
Backspace Cursor	←	1B 5B 44H
Down Cursor	↓	1B 5B 42H
Up Cursor	↑	1B 5B 41H
Forward Space Cursor	→	1B 5B 43H
Home	NK 0	1B 4F 70H
Tab	TAB	09H
Back Tab	BACKSPACE	08H
Delete	DELETE	7FH
New Line	LINE FEED	0AH
Duplicate	NK 6	1B 4F 76H
Field Mark	NK ,	1B 4F 6CH
Insert Mode	NK .	1B 4F 6EH
Erase to End of Field	NK 4	1B 4F 74H
Erase Input	NK 7	1B 4F 77H
Enter	RETURN or ENTER	0DH 1B 4F 4DH
Clear	NK -	1B 4F 6DH
Sys Request	NK 9	1B 4F 79H
PF1	PF1 or ESC 1	1B 4F 50H 1B 31H

3278 Function	Key Sequence	Hex Value Generated
PF2	PF2 or ESC 2	1B 4F 51H 1B 32H
PF3	PF3 or ESC 3	1B 4F 52H 1B 33H
PF4	PF4 or ESC 4	1B 4F 53H 1B 34H
PF5	ESC 5	1B 35H
PF6	ESC 6	1B 36H
PF7	ESC 7	1B 37H
PF8	ESC 8	1B 38H
PF9	ESC 9	1B 39H
PF10	ESC 0	1B 30H
PF11	ESC ! or ESC -	1B 21H 1B 2DH
PF12	ESC @ or ESC =	1B 40H 1B 3DH
PF13	ESC #	1B 23H
PF14	ESC \$	1B 24H
PF15	ESC %	1B 25H
PF16	ESC ^	1B 5EH
PF17	ESC &	1B 26H
PF18	ESC *	1B 2AH
PF19	ESC (1B 28H
PF20	ESC)	1B 29H
PF21	ESC ESC 1	1B 1B 31H
PF22	ESC ESC 2	1B 1B 32H
PF23	ESC ESC 3	1B 1B 33H
PF24	ESC ESC 4	1B 1B 34H
PA1	NK 1	1B 4F 71H
PA2	NK 2	1B 4F 72H
PA3	NK 3	1B 4F 73H
Print	NK 8	1B 4F 78H
Cursor Select	NK 5	1B 4F 75H
Attention	ESC \	1B 5CH
Device Cancel	ESC]	1B 5DH
Ident	ESC :	1B 3AH
Test	ESC ;	1B 3BH
Special Function	Key Sequence	Hex Value Generated
Numeric Override	ESC {	1B 7BH
Refresh Screen	CTRL/W	17H
Initialize Terminal	ESC <	1B 3CH
Display Status Line	ESC _ (underline)	1B 5FH

G.48 VT52 Terminal Module—DEC VT52

To set up the DEC VT52™ terminal for connection to the A/C-4 (B) in order to emulate the 3278, proceed as follows:

1. Connect the terminal to the A/C-4 (B) port (modem or direct cable) as appropriate.
2. The only switch settings available for the VT52 are the baud rate settings. On the rear of the terminal there are two rotary switches available to make these settings. The one on the right when facing the rear of the terminal is S1. On S1, the most counterclockwise position is Position 1. On S2, the most counterclockwise position is Position A. One switch (usually S1) is for the transmission rate, the other for the reception rate. These rates should be the same. Choose one of the following baud rate settings for full duplex operation, without local copy.

Baud Rate	Transmission Switch (S1) Setting	Reception Switch (S2) Setting
9600	Position 3	Position G
4800	Position 7	Position C
2400	Position 3	Position F
1200	Position 3	Position E
300	Position 4	Position C
110	Position 3	Position B

Keyboard Emulation

Following is a table showing how the DEC VT52 keyboard is used in emulation of the 3278 keyboard.

NOTES:

1. Press <Ctrl> concurrently with the indicated key.
2. Press <Esc> prior to pressing the indicated key.
3. NK indicates that the indicated key is found in the numeric keypad at the lower right of the keyboard (the A/C-4 (B) sets the keypad to Alternate keypad mode). For VT52 terminals having no numeric keypad, a terminal driver (terminal ID = VT52X) is provided.
4. The last character on the screen (the line-24, column-80 character position) cannot be displayed. This feature is designed to defeat the DEC Auto-Scroll capability.

3278 Function	Key Sequence	Hex Value Generated
Reset	CTRL/R	12H
Backspace Cursor	←	1B 44H
Down Cursor	↓	1B 42H
Up Cursor	↑	1B 41H
Forward Space Cursor	→	1B 43H
Home	NK 0	1B 3F 70H
Tab	TAB	09H
Back Tab	BACKSPACE	08H
Delete	DELETE	7FH
New Line	LINE FEED	0AH
Duplicate	NK 6	1B 3F 76H
Field Mark	NK , or CTRL/F	1B 3F 6CH 06H
Insert Mode	NK .	1B 3F 6EH

3278 Function	Key Sequence	Hex Value Generated
Erase to End of Field	NK 4	1B 3F 74H
Erase Input	NK 7	1B 3F 77H
Enter	RETURN or ENTER	0DH 1B 3F 4DH
Clear	NK - or CTRL/Z	1B 3F 6DH 1AH
Sys Request	NK 9	1B 3F 79H
PF1	ESC 1 or PF1	1B 31H 1B 50H
PF2	ESC 2 or PF2	1B 32H 1B 51H
PF3	ESC 3 or PF3	1B 33H 1B 52H
PF4	ESC 4 or PF4	1B 34H 1B 53H
PF5	ESC 5	1B 35H
PF6	ESC 6	1B 36H
PF7	ESC 7	1B 37H
PF8	ESC 8	1B 38H
PF9	ESC 9	1B 39H
PF10	ESC 0	1B 30H
PF11	ESC ! or ESC -	1B 21H 1B 2DH
PF12	ESC @ or ESC =	1B 40H 1B 3DH
PF13	ESC #	1B 23H
PF14	ESC \$	1B 24H
PF15	ESC %	1B 25H
PF16	ESC ^	1B 5EH
PF17	ESC &	1B 26H
PF18	ESC *	1B 2AH
PF19	ESC (1B 28H
PF20	ESC)	1B 29H
PF21	ESC ESC 1	1B 1B 31H
PF22	ESC ESC 2	1B 1B 32H
PF23	ESC ESC 3	1B 1B 33H
PF24	ESC ESC 4	1B 1B 34H
PA1	NK 1	1B 3F 71H
PA2	NK 2	1B 3F 72H
PA3	NK 3	1B 3F 73H
Print	NK 8	1B 3F 78H
Cursor Select	NK 5	1B 3F 75H
Attention	ESC \	1B 5CH
Device Cancel	ESC]	1B 5DH
Ident	ESC :	1B 3AH
Test	ESC ;	1B 3BH

A/C-4 (B)

Special Function	Key Sequence	Hex Value Generated
Numeric Override	ESC {	1B 7BH
Refresh Screen	CTRL/W	17H
Initialize Terminal	ESC <	1B 3CH
Display Status Line	ESC _ (underline)	1B 5FH

G.49 VT52X Terminal Module—DEC VT52 without Numeric Keypad

To set up the DEC VT52 terminal for connection to the A/C-4 (B) in order to emulate the 3278, proceed as follows:

1. Connect the terminal to the A/C-4 (B) port (modem or direct cable) as appropriate.
2. The only switch settings available for the VT52 are the baud rate settings. On the rear of the terminal, there are two rotary switches available to make these settings. The one on the right when facing the rear of the terminal is S1. On S1, the most counterclockwise position is Position 1. On S2, the most counterclockwise position is Position A. One switch (usually S1) is for the transmission rate, the other for the reception rate. These rates should be the same. Choose one of the following baud rate settings for full-duplex operation, without local copy.

Baud Rate	Transmission Switch (S1) Setting	Reception Switch (S2) Setting
9600	Position 3	Position G
4800	Position 7	Position C
2400	Position 3	Position F
1200	Position 3	Position E
300	Position 4	Position C
110	Position 3	Position B

Keyboard Emulation

Following is a table showing how the DEC VT52 keyboard is used in emulation of the 3278 keyboard.

NOTES:

1. Press <Ctrl> concurrently with the indicated key.
2. Press <Esc> prior to pressing the indicated key.
3. The last character on the screen (the line-24, column-80 character position) cannot be displayed. This feature is designed to defeat the DEC Auto-Scroll capability.

3278 Function	Key Sequence	Hex Value Generated
Reset	CTRL/R	12H
Backspace Cursor	←	1B 44H
Down Cursor	↓	1B 42H
Up Cursor	↑	1B 41H
Forward Space Cursor	→	1B 43H
Home	CTRL/^	1EH
Tab	TAB	09H
Back Tab	BACKSPACE	08H
Delete	DELETE	7FH
New Line	LINE FEED	0AH
Duplicate	CTRL/D	04H
Field Mark	CTRL/F	06H
Insert Mode	CTRL/U	15H
Erase to End of Field	CTRL/E	05H
Erase Input	CTRL/X	18H
Enter	RETURN	0DH
Clear	CTRL/Z	1AH
Sys Request	ESC ?	1B 3FH

A/C-4 (B)

3278 Function	Key Sequence	Hex Value Generated
PF1	ESC 1 or PF1	1B 31H 1B 50H
PF2	ESC 2 or PF2	1B 32H 1B 51H
PF3	ESC 3 or PF3	1B 33H 1B 52H
PF4	ESC 4 or PF4	1B 34H 1B 53H
PF5	ESC 5	1B 35H
PF6	ESC 6	1B 36H
PF7	ESC 7	1B 37H
PF8	ESC 8	1B 38H
PF9	ESC 9	1B 39H
PF10	ESC 0	1B 30H
PF11	ESC ! or ESC -	1B 21H 1B 2DH
PF12	ESC @ or ESC =	1B 40H 1B 3DH
PF13	ESC #	1B 23H
PF14	ESC \$	1B 24H
PF15	ESC %	1B 25H
PF16	ESC ^	1B 5EH
PF17	ESC &	1B 26H
PF18	ESC *	1B 2AH
PF19	ESC (1B 28H
PF20	ESC)	1B 29H
PF21	ESC ESC 1	1B 1B 31H
PF22	ESC ESC 2	1B 1B 32H
PF23	ESC ESC 3	1B 1B 33H
PF24	ESC ESC 4	1B 1B 34H
PA1	ESC Z	1B 5AH
PA2	ESC X	1B 58H
PA3	ESC C	1B 43H
Print	CTRL/P	10H
Cursor Select	CTRL/C	03H
Attention	ESC \	1B 5CH
Device Cancel	ESC]	1B 5DH
Ident	ESC :	1B 3AH
Test	ESC ;	1B 3BH

Special Function	Key Sequence	Hex Value Generated
Numeric Override	ESC {	1B 7BH
Refresh Screen	CTRL/W	17H
Initialize Terminal	ESC <	1B 3CH
Display Status Line	ESC _ (underline)	1B 5FH

G.50 WY100 Terminal Module—WYSE WY-100

To set up the Wyse® WY-100 terminal for connection to the A/C-4 (B) in order to emulate the 3278, proceed as follows.

1. Disconnect the AC power cord from the outlet before setting the option switches.
2. There are three banks of toggle-type switches each with 8 switches located on the keyboard. These switches should be set to the following values:

SW1	Set to:	Comments
1	ON	Edit keys are set up as duplex keys (host controllable)
2	OFF	End of Line = US End of Transmission = CR
3	ON	Disable auto-new-line
4	ON	ENTER and RETURN both generate CR character
5-8	see below	Sets the Printer Port baud rate

SW2	Set to:	Comments
1	ON	8-bit data
2	as desired	ON = Even parity OFF = Odd parity
3	OFF	1 stop bit. If a baud rate 110 or less is selected, set to ON = 2 stop bits
4	OFF	Parity disabled
5-8	see below	Sets the modem port baud rate

Baud Rate	Switches			
	5	6	7	8
9600	OFF	OFF	OFF	ON
4800	OFF	OFF	ON	ON
2400	OFF	ON	OFF	ON
1200	ON	OFF	OFF	OFF
300	ON	OFF	ON	OFF
110	ON	ON	OFF	ON

SW3	Set to	Comments
1	OFF	1 page (1920 character) memory
2	as required	OFF = 60 Hz power source ON = 50 Hz power source
3, 4	OFF	Normal Display mode
5	as desired	OFF = Black screen ON = White screen
6	as desired	OFF = Blinking cursor ON = Non-blinking cursor
7	OFF	Full Duplex
8	OFF	Conversation Mode

3. Reconnect the AC power cord and connect the terminal to the A/C-4 (B) port (or modem, etc.) as appropriate.

Keyboard Emulation

Following is a table showing how the Wyse WY-100 keyboard is used in emulation of the 3278 keyboard.

NOTES:

1. Press <Ctrl> and <Shift> concurrently with the indicated key.
2. Press <Esc> prior to pressing the indicated key.
3. The last character on the screen (the line-24, column-80 character position) cannot be displayed. This feature is designed to defeat the Wyse WY-100 Auto-Scroll capability.

3278 Function	Key Sequence	Hex Value Generated
Reset	SEND PAGE	1B 35H
Backspace Cursor	← or BACKSPACE	08H
Down Cursor	↓ or LINEFEED	0AH
Up Cursor	↑	0BH
Forwardspace Cursor	→	0CH
Home	HOME	1EH
Tab	TAB	09H
Backtab	SHIFT/TAB	1B 49H
Delete	RUBOUT	7FH
New Line	NEW LINE	1FH
Duplicate	DEL/INS CHAR	1B 51H
Field Mark	SOM/EOM	1B 39H
Insert Mode	LINE INSERT	1B 45H
Erase to End of Field	LINE DELETE	1B 52H
Erase Input	LINE ERASE	1B 54H
Enter	RETURN or ENTER	0DH
Clear	PAGE ERASE	1B 59H
System Request	SEND MSG	1B 53H
PF1	F1	02 30H
PF2	F2	02 31H
PF3	F3	02 32H
PF4	F4	02 33H
PF5	F5	02 34H
PF6	F6	02 35H
PF7	F7	02 36H
PF8	F8	02 37H
PF9	SHIFT/F1	02 38H
PF10	SHIFT/F2	02 39H
PF11	SHIFT/F3	02 3AH
PF12	SHIFT/F4	02 3BH
PF13	SHIFT/F5	02 3CH
PF14	SHIFT/F6	02 3DH
PF15	SHIFT/F7	02 3EH
PF16	SHIFT/F8	02 3FH
PF17	ESC F1 1B	02 30H
PF18	ESC F2 1B	02 31H
PF19	ESC F3 1B	02 32H
PF20	ESC F4 1B	02 33H
PF21	ESC F5 1B	02 34H
PF22	ESC F6 1B	02 35H

P3278 Function	Key Sequence	Hex Value Generated
PF23	ESC F7	1B 02 36H
PF24	ESC F8	1B 02 37H
PA1	SCRN EDIT	1B 4EH
PA2	SET TAB	1B 31H
PA3	PAGE	1B 68H
Print	PRINT	1B 40H
Cursor Select	SEND LINE	1B 34H
Attention	ESC \	1B 5CH
Device Cancel	SHIFT/PRINT	1B 50H
Ident	ESC :	1B 3AH
Test	ESC ;	1B 3BH
Fast Forwardspace	SCRL DOWN	1B 76H
Fast Backspace	INS/REP	1B 72H
Special Funtion	Key Sequence	Hex Value Generated
Numeric Override	SCRL UP	1B 77H
Refresh Screen	CTRL/W	17H
Initialize Terminal	ESC <	1B 3CH
Display Status Line	ESC _ (underline)	1B 5FH

A

AC INPUT, 14
ACT5A Terminal Module, 59
ADM11 Terminal Module, 62
ADM12 Terminal Module, 65
ADM178 Terminal Module, 67
ADM21 Terminal Module, 70
ADM24E Terminal Module, 73
ADM2D Terminal Module, 76
ADM3A Terminal Module, 79
ADM3P Terminal Module, 82
ANSI Terminal Module, 85
Auto-Skip Capability, 54

B

Banner Message, 33
Baud Rate, 29

C

C108 Terminal Module, 87
C530 Terminal Module, 90
Cable Requirements, 19
Changing the EPROM, 38
Coax Cable, 19
COMPU, 6
COMPU Terminal Module, 95
Configuration, 21, 23, 28
Connect Mode, 31
Connect Password, 31
CU SIG, 13
CU SIG Indicator Failure, 37
Cursor Control, 54

D

D450 Terminal Module, 97
Data Bits, 29
DCE/DTE Pushbutton, 14
DG200 Terminal Module, 100
Diagnostic Test Failure, 36
DISPI Terminal Module, 102
Display Case, 30
Display Codes, 45
Display Fields, 54
Display status line, 6, 45, 57
DM20 Terminal Module, 105
DM5 Terminal Module, 111
DM5AB Terminal Module, 115
DM78 Terminal Module, 118

E

Echo Suppression, 33
Emulation, 5, 23
Emulators, 5
EPROM Test Failure, 36
Exit and Save, 34

F

Flashing Asterisk, 33
Flow Control, 29
Forced Logoff, 31

H

HP125 Terminal Module, 121
HP21 Terminal Module, 124
HP45 Terminal Module, 127
HZ14 Terminal Module, 130
HZ150 Terminal Module, 133
HZ151 Terminal Module, 136
HZ78 Terminal Module, 139

I

I3101 Terminal Module, 141
I3161 Terminal Module, 144
IBMPC, 6
IBMPC Terminal Module, 147
Inactivity Disconnect, 31
INF205 Terminal Module, 149
Initialize terminal, 6, 57

J

J3 Connector, 14
J4 Connector, 14
J5 BNC Connector, 14

K

Keyboard Functions, 54

L

Logon, 23
Logon Menu, 25
Logon Mode, 25

M

Main Port, 15
Models, 6
Modems, 21

N

Number Codes, 47
Numeric Lock , 30
Numeric override, 6, 57

P

Parity, 29
Passthrough, 23
Passthrough Port, 12, 18, 21
Passthrough Signals, 32
PASSTHRU, 13
Power Requirements, 19
POWER Switch, 14
Prompt Failure, 36
PWR, 13

R

RAM Test Failure, 36
Refresh screen, 6, 57
Remote Applications, 21
RS-232 Cable, 19
RXD, 13

S

SCANS Terminal Module, 151
System Indicators, 54

T

T4420 Terminal Module, 154
T5410 Terminal Module, 157
T5420 Terminal Module, 159
Terminal Emulators, 6
Terminal Type , 28
Terminal-Host Session, 23
TV910 Terminal Module, 162
TV910P Terminal Module, 165
TV925 Terminal Module, 169
TV970 Terminal Module, 173
TXD, 13
Typeahead, 33

V

VIEWC Terminal Module, 176
VIEWP Terminal Module, 179
VIP731 Terminal Module, 184
VP60 Terminal Module, 187
VP78 Terminal Module, 190
VP78C Terminal Module, 193
VT100 Terminal Module, 196
VT102 Terminal Module, 199
VT52 Terminal Module, 202
VT52X Terminal Module, 205

W

WY100 Terminal Module, 207



© Copyright 1996. Black Box Corporation. All rights reserved.

1000 Park Drive • Lawrence, PA 15055-1018 • 724-746-5500 • Fax 724-746-0746