

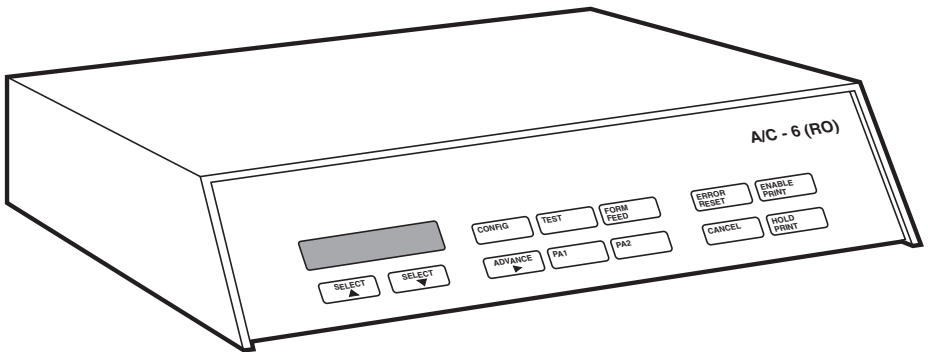

## A/C—6 (R/O)



**CUSTOMER  
SUPPORT  
INFORMATION**

Order toll-free in the U.S.: Call **877-877-BBOX** (outside U.S. call **724-746-5500**)  
FREE technical support 24 hours a day, 7 days a week: Call **724-746-5500** or fax **724-746-0746**  
Mailing address: **Black Box Corporation**, 1000 Park Drive, Lawrence, PA 15055-1018  
Web site: [www.blackbox.com](http://www.blackbox.com) • E-mail: [info@blackbox.com](mailto:info@blackbox.com)

**FEDERAL COMMUNICATIONS COMMISSION  
AND  
INDUSTRY CANADA  
RADIO FREQUENCY INTERFERENCE STATEMENTS**

This equipment generates, uses, and can radiate radio frequency energy and if not installed and used properly, that is, in strict accordance with the manufacturer's instructions, may cause interference to radio communication. It has been tested and found to comply with the limits for a Class A computing device in accordance with the specifications in Subpart J of Part 15 of FCC rules, which are designed to provide reasonable protection against such interference when the equipment is operated in a commercial environment. Operation of this equipment in a residential area is likely to cause interference, in which case the user at his own expense will be required to take whatever measures may be necessary to correct the interference.

Changes or modifications not expressly approved by the party responsible for compliance could void the user's authority to operate the equipment.

*This digital apparatus does not exceed the Class A limits for radio noise emission from digital apparatus set out in the Radio Interference Regulation of Industry Canada.*

*Le présent appareil numérique n'émet pas de bruits radioélectriques dépassant les limites applicables aux appareils numériques de la classe A prescrites dans le Règlement sur le brouillage radioélectrique publié par Industrie Canada.*

**TRADEMARKS**

ACX® is a registered trademark of Autovative Computer Extensions, Inc.  
 C. Itoh® is a registered trademark of C. Itoh Electronics, Inc.  
 Dataproducts® is a registered trademark of Dataproducts Corporation.  
 Epson® is a registered trademark of Dataproducts Corporation.  
 HP® and LaserJet® are registered trademarks of Hewlett-Packard.  
 IBM®, GDDM®, Proprinter®, and IPDS™ are registered trademarks or trademarks of International Business Machines Corporation.  
 SAS® and SAS-GRAPH® are registered trademarks of SAS Institute, Inc.  
 Windows® is a registered trademark of Microsoft Corporation.  
 Xerox® and Diablo® are registered trademarks of Xerox Corporation.  
 All applied-for and registered trademarks are the property of their respective owners.

*Any other trademarks mentioned in this manual are acknowledged to be the property of the trademark owners.*

## **NORMAS OFICIALES MEXICANAS (NOM) ELECTRICAL SAFETY STATEMENT**

### **INSTRUCCIONES DE SEGURIDAD**

1. Todas las instrucciones de seguridad y operación deberán ser leídas antes de que el aparato eléctrico sea operado.
2. Las instrucciones de seguridad y operación deberán ser guardadas para referencia futura.
3. Todas las advertencias en el aparato eléctrico y en sus instrucciones de operación deben ser respetadas.
4. Todas las instrucciones de operación y uso deben ser seguidas.
5. El aparato eléctrico no deberá ser usado cerca del agua—por ejemplo, cerca de la tina de baño, lavabo, sótano mojado o cerca de una alberca, etc..
6. El aparato eléctrico debe ser usado únicamente con carritos o pedestales que sean recomendados por el fabricante.
7. El aparato eléctrico debe ser montado a la pared o al techo sólo como sea recomendado por el fabricante.
8. Servicio—El usuario no debe intentar dar servicio al equipo eléctrico más allá a lo descrito en las instrucciones de operación. Todo otro servicio deberá ser referido a personal de servicio calificado.
9. El aparato eléctrico debe ser situado de tal manera que su posición no interfiera su uso. La colocación del aparato eléctrico sobre una cama, sofá, alfombra o superficie similar puede bloquea la ventilación, no se debe colocar en libreros o gabinetes que impidan el flujo de aire por los orificios de ventilación.
10. El equipo eléctrico deber ser situado fuera del alcance de fuentes de calor como radiadores, registros de calor, estufas u otros aparatos (incluyendo amplificadores) que producen calor.
11. El aparato eléctrico deberá ser conectado a una fuente de poder sólo del tipo descrito en el instructivo de operación, o como se indique en el aparato.

12. Precaución debe ser tomada de tal manera que la tierra física y la polarización del equipo no sea eliminada.
13. Los cables de la fuente de poder deben ser guiados de tal manera que no sean pisados ni pellizcados por objetos colocados sobre o contra ellos, poniendo particular atención a los contactos y receptáculos donde salen del aparato.
14. El equipo eléctrico debe ser limpiado únicamente de acuerdo a las recomendaciones del fabricante.
15. En caso de existir, una antena externa deberá ser localizada lejos de las líneas de energía.
16. El cable de corriente deberá ser desconectado del cuando el equipo no sea usado por un largo periodo de tiempo.
17. Cuidado debe ser tomado de tal manera que objetos líquidos no sean derramados sobre la cubierta u orificios de ventilación.
18. Servicio por personal calificado deberá ser provisto cuando:
  - A: El cable de poder o el contacto ha sido dañado; u
  - B: Objetos han caído o líquido ha sido derramado dentro del aparato; o
  - C: El aparato ha sido expuesto a la lluvia; o
  - D: El aparato parece no operar normalmente o muestra un cambio en su desempeño; o
  - E: El aparato ha sido tirado o su cubierta ha sido dañada.

# Contents

<b>Chapter</b>	<b>Page</b>
1. Specifications .....	8
2. Introduction .....	9
2.1 Overview .....	9
2.2 Features Overview .....	10
2.2.1 Key Features .....	10
2.2.2 Unsupported Features .....	11
3. Installation .....	12
3.1 Overview .....	12
3.2 Host Configuration Requirements .....	13
3.3 Cable Requirements .....	13
3.4 Installation Instructions .....	14
3.5 Printer Sharing .....	17
4. Operation/Emulation Overview .....	24
4.1 IBM Emulation and Compatibility .....	24
4.2 DSC and SCS Printing Modes .....	25
4.3 Printer Drivers .....	26
4.4 Presets .....	26
4.5 Printer Initialization Strings .....	26
4.6 Character Translation Tables .....	27
4.7 Special Applications .....	28
5. Configuration .....	29
5.1 System Configuration .....	29
5.2 Front-Panel Configuration .....	31
5.2.1 Configuration Pushbuttons .....	31
5.2.2 Front-Panel Menu Trees .....	32
5.2.3 Front-Panel Configuration Example .....	35
5.2.4 Front-Panel Menus, Parameters, and Options .....	36
5.3 Coax Configuration Download .....	43
6. Operation .....	50
6.1 On-line Mode (Enable Print) .....	51
6.2 Off-line Mode (Hold Print) .....	53
Appendix A: Configuration Option Commands .....	54
Appendix B: SCS Mode Printing .....	99
B.1 SCS Page Format .....	99
B.2 SCS Control Codes .....	100
B.3 Special SCS Code .....	109

Chapter	Page
Appendix C: DSC Mode Printing .....	110
C.1 Host Software Considerations .....	110
C.2 DSC Page Format .....	110
C.3 DSC Control Codes.....	112
Appendix D: Character-Translation Tables .....	115
D.1 Character-Translation Overview .....	116
D.2 SCS Character-Translation Table .....	117
D.3 DSC Character-Translation Table.....	120
D.4 Printer Character-Translation Table .....	123
D.5 International Language Changes .....	132
D.6 Individual Character Changes .....	132
D.7 Translation Example .....	134
Appendix E: Transparent Data Transfer.....	135
E.1 Hex Transfer Method .....	135
E.2 Two Modes of Hex Transfer.....	138
E.3 Host Software Considerations .....	144
E.4 SCS Mode Transparent Data .....	144
E.5 Transparent Data Transfer Options.....	145
E.6 Pseudo-Transparency Example .....	146
Appendix F: Application Programming Tips.....	148
F.1 IBM System Considerations .....	148
F.2 Sending Escape Sequences .....	148
F.3 Micro Spacing to Enabled Bold Typeface.....	152
F.4 Permanent Page Format Storage.....	153
F.5 Downloading Fonts and Raster Graphics.....	153
Appendix G: Printer Drivers .....	154
G.1 Supported Printers .....	154
G.2 Printer Setup .....	154
G.3 Printer Emulation .....	154
Appendix H: Diagnostic Dump .....	177
H.1 DSC Mode Diagnostic Dump.....	177
H.2 SCS (LU1) Mode Diagnostic Dump.....	179
Appendix I: Interface Specifications .....	180
I.1 Asynchronous Serial Communication .....	180
I.2 Coax Input/Output .....	183
I.3 Serial Interface .....	184
I.4 Parallel Interface .....	186
Appendix J: Quick Reference .....	188
Appendix K: Troubleshooting .....	198
K.1 Troubleshooting .....	198
K.2 Error Messages .....	201

# 1. Specifications

**Protocol** — IBM® 3270

**System Requirements** — IBM 3X74 or compatible controller

**Speed** — Coax: 2.35 MHz; Serial: 9600 bps

**Emulation** — IBM 3287

**Interface** — Centronics parallel, RS-232 DTE/DCE, and Type A coax

**Connectors** — (1) DB25 male (serial), (1) DB25 female (parallel),  
(1) RJ-45 female, (1) BNC female

**Power** — 115/230 VAC selectable, 60/50 Hz, 7 watts

**Size** — 2.7"H x 12"W x 8.5"D (6.9 x 30.5 x 21.6 cm)

**Weight** — 4.3 lb. (2 kg)

## 2. Introduction

### 2.1 Overview

The A/C—6 (RO) is a reliable, multi-featured standalone printer adapter that provides a feature-by-feature emulation of an IBM 3287 Model 2 printer in both DSC/LU3 and SCS/LU1 modes. A/C—6 (RO) connects asynchronous ASCII printers or similar output or ASCII data capture devices to 3270 host systems, specifically the IBM 3274, 3174 and 3276 control units. To the IBM system, A/C—6 (RO) appears as an IBM 3287 Model 2 printer.

A/C—6 (RO) connects to the IBM 3X74/3276 control unit via a Type A coax port and performs the protocol conversion from the coax interface into either a serial RS-232C interface or a parallel Centronics interface. A/C—6 (RO) is compatible with all models and configurations of IBM 3X74 and 3276 control units.

SCS print format commands are translated into printer-specific commands by A/C—6 (RO) printer drivers. The user-definable printer-driver feature set provides the means to support almost any ASCII printer.

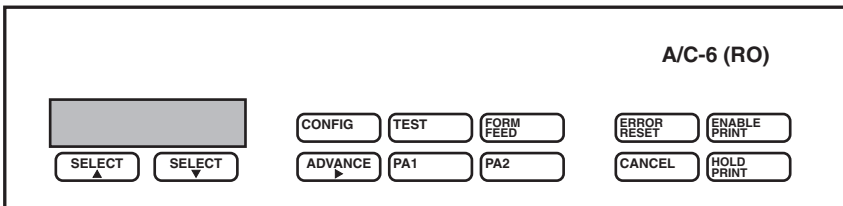

Figure 2-1. The A/C—6 (RO).



## 2.2 Feature Overview

### 2.2.1 KEY FEATURES

- **Easy Installation.**
- **Printer Sharing** allows the printer to be fully used and is transparent to the user; no switches or special keystrokes are required.
- **Printer Drivers** convert SCS commands into the command language of the target printer (if this is not desired, use the TTY driver).
- **User-Definable Printer Driver** allows customization of SCS format command translation to accommodate non-standard printers or effects.
- **Two Configuration Methods:**

- *Front-Panel Configuration:*

You can configure A/C—6 (RO) using convenient front-panel controls. You can readily choose options through menus. Once A/C—6 (RO) is configured, all options are permanently stored in non-volatile EEPROM.

- *Configuration Download:* You can also configure A/C—6 (RO) from the host datastream by creating a text file containing configuration parameters or embedded commands in the text of your document and routing it to A/C—6 (RO) as a print job.

- **Configuration Presets** allow you to define and activate, through datastream commands, up to eight global configurations in order to accommodate various application printing requirements.
- **Printer Initialization Strings** let you customize initial printer settings on power on or send them to the printer using datastream configuration commands.
- **User-definable Translation Tables** allow custom host-printer character translation through ASCII-ASCII translation.
- **Graphic Support** lets you use A/C—6 (RO) to drive an HP® plotter or laser printer directly from SAS-GRAPH®, C/A TELLAGRAF or from GDDM® using Maersk or ACX® software.
- **Supports All Cabling Media:** You can connect A/C—6 (RO) to the host computer with either standard coax cable or inexpensive twisted-pair wire. (An RJ-45 telephone-type connector and internal balun make it easy to use A/C—6 (RO) in cost-effective and flexible wiring schemes.)
- **Several Transparency methods** let you send printer escape sequences from the host to select fonts or use any other printer feature.

- **Pseudo-Transparency:** A/C—6 (RO) allows you to bypass limitations imposed by the IBM system to access the entire range of your ASCII printer's features (graphics, multiple fonts, etc.). Using transparent commands, A/C—6 (RO) will support almost any print device, such as barcode printers and plotters, as well as transmit all 256 hex codes from the host.
- **SCS code 35 transparency supported.**
- **Diagnostic Dump Mode:** When this is enabled from the front panel, A/C—6 (RO) will display the IBM system commands and printer data before translating them, for easy system troubleshooting.
- **International Language Support:** All 29 standard IBM LU1 language character sets are resident. In addition, up to eight customized translation tables can be easily set up to suit special printers or particular customer needs.
- **7-bit ASCII ROMAN-8, IBM PC and ISO character sets.**
- **Fully IBM-compatible run-time controls.**
- **Limited Extended Attribute Buffer (EAB) support.**
- **Printer drivers for most popular printers.**

### 2.2.2 UNSUPPORTED FEATURES

The following features and functions are not supported by A/C—6 (RO):

- APL/TEXT
- Programmed Symbols
- IPDS™
- AFP (Advanced Function Printing)
- GDDM

Some of the above functions can be emulated using host software from SAS®, Maersk, or ACX® that converts the datastream into the target printer commands and sends them to the coax adapter in pseudo-transparency.

- Dataproducts® parallel-port interface.
- Printer sharing with a serial printer. Printer sharing is supported only with a parallel printer.

## 3. Installation

### 3.1 Overview

A/C—6 (RO) allows ASCII printers or other ASCII devices to emulate an IBM model 2 printer in both DSC and SCS modes. Installation is easy and straightforward, and consists of the following basic steps:

1. Define A/C—6 (RO) as a 3287 model 2 DSC or SCS printer in VTAM, unless it is replacing an existing 3287 or clone.
2. Connect A/C—6 (RO) to the control unit using coax or twisted pair.
3. Connect the printer(s) and passthrough printing source device to A/C—6 (RO).
4. Configure A/C—6 (RO), if necessary. Basic host printing to any parallel printer can be done out of the box.
5. Try an A/C—6 (RO) test or configuration print to verify connections and settings.
6. Try a passthrough print, if being used, to verify connections and settings.
7. Try a host print.

After completing these steps, the following steps may be required, depending on your application requirements:

- Changing configuration settings from the default settings.
- Creating configuration presets.
- Creating printer initialization strings.
- Creating a user-defined printer driver.
- Creating a character-translation table.

A/C—6 (RO) can be connected to any of the following control units:

- IBM 3174.
- IBM 3274, using Type A coax adapter.
- IBM 3276, using Type A coax adapter.
- IBM 4321/31, using the DPA (Display/Printer Adapter).

- IBM 4341/81, using a console position.
- IBM 4361, using the DPA or workstation adapter.
- IBM 4701/02, using the DCA (Device Cluster Adapter).
- S/38, using 3174/3274 controller.

A/C—6 (RO) is coax-compatible with, and may be used in place of, the IBM printer models below:

- 3230 Model 2.
- 3262 Models 3, 13.
- 3268 Model 2.
- 3287 Models 1, 2.
- 3289 Models 1, 2, 3.
- 4214 Model 1.
- 5210 Models G01, G02.

A/C—6 (RO) is not compatible with the following IBM printer models:

- 3230 model 1
- 3262 models 1, 2, 5, 11, 12, B1, C1.
- 3268 models 1, 1C, 2C.
- 3284 models 1, 2, 3.
- 3286 models 1, 2.
- 3287 models 11, 12, 1C, 2C.
- 3289 model 4
- 38XX
- 4224

## 3.2 Host Configuration Requirements

If you are replacing an IBM 3287 model 2 or clone, no host changes should be required, as this is the printer emulated by A/C—6 (RO). The exception would be in cases where features being used are supported by A/C—6 (RO) (see **Section 2.2**).

## 3.3 Cable Requirements

- *Controller to A/C—6 (RO)*—RG62AU coax cable with BNC connectors, 5000 feet (1524 m) maximum length,  
or  
unshielded twisted pair with balun at the controller end.
- *A/C—6 (RO) to Parallel Printer*—Standard PC-type DB25 male to DB36 Amphenol connector, 15 feet (4.5 m) maximum length.

- *Serial Printer or Printer Sharing*—DB25 female on the A/C—6 (RO) end, DB25 male (usually) on the printer end.

Connection to an output device with a DCE interface requires a null-modem or crossover cable, as the A/C—6 (RO) serial port is wired as a DCE port.

### 3.4 Installation Instructions

#### NOTE

**Make sure that A/C—6 (RO) and the printer are both powered off before making any cable connections.**

1. Connect the A/C—6 (RO) power cord between the back-panel connector and a grounded (3-prong) outlet. Verify that the printer is also connected to a grounded outlet. The printer and A/C—6 (RO) must share a common ground. Do not use 2-wire extension cords or adapters designed to defeat this requirement. Switch A/C—6 (RO) on using the back-panel power switch.

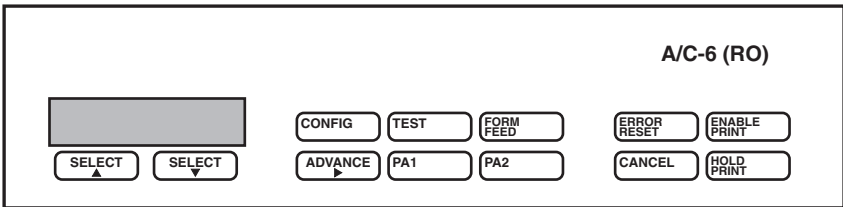

Figure 3-1. A/C—6 (RO).

2. If you are using a Centronics (PC-compatible) parallel cable to connect the printer to A/C—6 (RO), go to step 3. If your printer will be connected using a serial cable, the following front-panel procedure will select the serial interface (see **Figure 5-3** for the Advanced configuration parameters menu):
  - a. Press HOLD PRINT.
  - b. Press CONFIG.
  - c. Press SELECT Up Arrow to display the Advanced configuration parameters menu.
  - d. Press SELECT Down Arrow three times to display PRINTER PARMS.
  - e. Press ADVANCE Right Arrow to display PRINTER PORT.
  - f. Press ADVANCE Right to display PARALLEL.
  - g. Press SELECT Up to display SERIAL.
  - h. Press ADVANCE Right to save the serial selection.
  - i. Press SELECT Up to return to PRINTER PARMS.
  - j. Press SELECT Up three times to display UTILITIES.
  - k. Press ADVANCE Right to display SAVE PRESET.
  - l. Press ADVANCE Right to display PRESET 1.
  - m. Press ADVANCE Right to display WORKING,.....DONE.
  - n. Press SELECT Up to display UTILITIES.
  - o. Press CONFIG to exit configuration mode.

### NOTE

**The default serial communication parameters are:**

- 9600 baud, no parity, 8 data bits, 1 stop bit
- Hardware flow control—CTS (printer pin 20)

Select the corresponding options on your printer, or refer to the A/C—6 (RO) SERIAL DEFS menu to change the A/C—6 (RO) serial options to match the printer configuration.

3. Power off A/C—6 (RO) and connect the cable (serial or parallel) to the appropriate connector on the back panel. Power A/C—6 (RO) back on and connect the coax/twisted-pair cable from the controller to the coax port on the back panel of A/C—6 (RO). Power A/C—6 (RO) and the printer on.

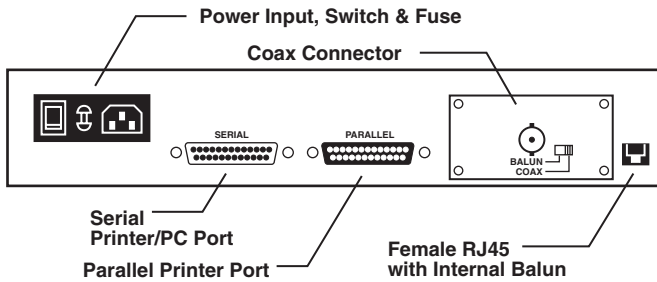

**Figure 3-2. Rear Panel of the A/C—6 (RO).**

4. Press **HOLD PRINT**, then **TEST**, to print the configuration and verify communication between the printer and A/C—6 (RO). A two-page configuration will print if A/C—6 (RO) is set up compatibly with the printer.
5. Press **ENABLE PRINT**. The Main status screen will display. You are now ready to test mainframe output to verify host system configuration.

### 3.5 Printer Sharing

Instead of using A/C—6 (RO) to drive a serial printer or other output device, you can connect an IBM or compatible personal computer or other serial input device to A/C—6 (RO)'s serial port to perform either passthrough printing or serial download of configuration commands.

Connect your PC COM port to A/C—6 (RO) using a standard EIA RS-232C straight-through cable. Use the DOS MODE command to configure your PC's COM port to meet A/C—6 (RO)'s specifications. Specifically:

```
MODE COM1:9600,n,8,1,P
```

This DOS function sets up COM1 to transfer data at 9600 baud with no parity, eight data bits and one stop bit. The P option indicates that COM1 will be used for a printer. Consult your DOS Reference for details.

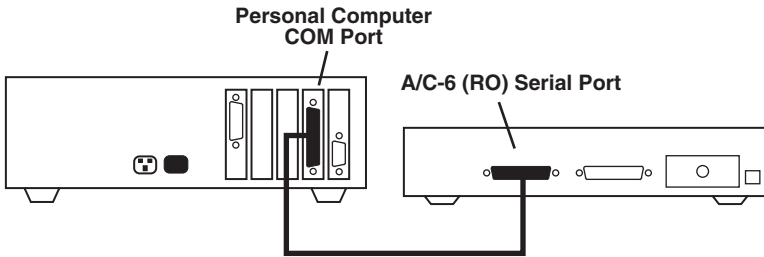

**Figure 3-3. Straight-Through Serial Connection.**



*Passthrough Printing/Printer Sharing Overview*

Passthrough printing allows the printer to be shared between the IBM host and a personal computer (PC), LAN printer server, or other serial or parallel output device without your intervention. While idle, the printer adapter polls the coax and serial ports and services the print jobs on a first-come-first-served basis. If a print job arrives on the other port, the adapter will hold off the other print job until the job in process is complete or the timeout (options K23 and K24) expires.

If the queued print job is on a serial port, A/C—6 (RO) will exert flow control to the serial device to suspend data transmission until the coax job has completed and the timeout setting for that port has expired.

If the subsequent print job is on the coax port, A/C—6 (RO) will accept the first host print data buffer but will withhold acknowledgment from the IBM host. This will suspend transmission of the subsequent host print buffers until the serial print job being serviced completes and the timeout value expires.

The default timeout values should work for most cases, but may need to be tuned for optimal results. A value that is too long will result in non-productive timeouts; a value that is too short will result in intermixing or interleaving of the host and passthrough print jobs.

We recommend that you try the default first and carefully adjust it only if necessary. Since the adapter has no way of detecting the end of a job, the timeout starts to count down when data is no longer being received. So, it's still possible that print jobs can become interleaved if the first job is interrupted.

A/C—6 (RO) contains one coax port, one Centronics parallel port and one DB25 RS-232C serial port. You can configure all passthrough settings from the A/C—6 (RO) front panel.

*Serial Passthrough Port*

The serial port on the adapter is a male DB25 RS-232C DCE interface. Use a straight-through cable when connecting to a DTE device (such as a personal computer's com port) and a cross-over/null-modem cable or null-modem adapter when connecting to a DCE device.

### *Serial Passthrough Cable Requirements*

We recommend that you use six pins in the cable between the adapter serial port and the serial passthrough source device, depending on the source device's requirements. For instance, some devices may not transmit data to the adapter unless Data Set Ready (DSR), Data Carrier Detect (DCD), and Clear to Send (CTS) are active/high.

For PC com ports, female connectors are used at both ends of the required cable. Your actual requirements may be different at the passthrough print source device, but the adapter end of the cable should always be female.

### **NOTE**

**No device-ready signal, such as Data Terminal Ready (DTR) or Request to Send (RTS), is required by the adapter in passthrough mode.**

### *Serial Port Flow Control*

Because parallel ports transfer data at much higher rates than serial ports, A/C—6 (RO) uses an extremely small buffer for passthrough printing. A/C—6 (RO) normally does not need to exert serial flow control unless a coax host print job is being serviced or a very slow parallel printer is connected.

A/C—6 (RO) and the passthrough print source device or software must agree on the flow-control signal to be used or data loss can result in either of these cases. This could appear as missing print data in text files, unwanted text characters appearing in graphics prints, missing portions of graphics prints or garbled/incorrect fonts being printed.

When serial flow control is incorrectly set, short jobs might print fine, but larger jobs may experience data loss. This occurs because the smaller jobs do not cause the printer to go busy because its input buffer becomes full, while the larger jobs do. If the source device does not respond to A/C—6 (RO)'s flow control, data will be lost.

Many applications do not provide for choice of flow-control method. Such applications usually rely on the hardware signaling, or handshaking on the com port. With these types of applications, A/C—6 (RO) should use CTS flow control (default), since such an application will probably not support XON/XOFF.

*Sending Print Jobs to the PC Com Port*

If the PC application allows the print to be directed to the serial port, it will usually allow the setting of baud rate, parity, stop bits, and flow control. If it does not, you will have to use the DOS MODE.COM function to configure the serial port.

For this to work, MODE.COM must be on the PC hard disk or floppy disk. It must also be in the same directory as the application or must be in a directory contained in the PATH statement (e.g. C:\DOS), which is usually found in the AUTOEXEC.BAT file. The MODE.COM command can be included in the AUTOEXEC.BAT file or in a batch file used just prior to passthrough printing or in a batch file used to activate the PC application program.

If the PC application does not allow the print output to be directed to the serial port, the DOS MODE.COM function must be used to redirect the print jobs.

The MODE.COM commands are used as follows:

1. To redirect the LPT port to a com port:  
**MODE LPTx:=COMx:**, where x is the number of the LPT port and COM port.
2. To configure the serial port: **MODE COMx:96,n,8,1,P**. This sets the baud rate to 9600 baud, no parity, 8 bits per character, and turns indefinite retry on.

### NOTE

**The default DOS configuration of the serial port is 9600 baud, even parity, 7 bits per character and no retry. If you redirect the LPT to a com port, you should also use the command shown to set the com port to match A/C—6 (RO).**

3. To set the LPT port for indefinite retry:  
**MODE LPTx:,,P**

### *Passthrough Printing from Windows® Applications*

If you are using Windows version 3.0, we recommend that you upgrade to 3.1, since data loss has been observed with 3.0 even when flow control is set correctly. Print jobs are usually routed to a serial port by assigning the printer to the appropriate serial port within the particular Windows application. All Windows programs use the Windows serial port settings for speed, parity, and flow control.

### NOTE

**The Windows default flow control setting is None and must be changed in order for passthrough printing to work correctly.**

To configure Windows serial port flow control, proceed as follows:

1. Open Control Panel (Main window).
2. Select the Ports icon.
3. Select the com port icon that matches your printer's application assignment.
4. Select Settings.
5. Select hardware or XON/XOFF to match the A/C—6 (RO) setting, click the OK button and exit all the way back to your application.

*Setting Up Passthrough Printer Sharing*

To set up printer sharing, proceed as follows:

1. Configure the A/C—6 (RO) serial port to match the passthrough print source device's baud rate, parity, stop bits and flow control. The A/C—6 (RO) parallel port cannot be configured except for the passthrough timeout. Save changes to the power-on preset.
2. Obtain the correct cable(s) and connect A/C—6 (RO) to the passthrough print source device.
3. Make the necessary changes, if any, on the passthrough print source device to match the settings from step 1.
4. Try a short print job to make sure that basic passthrough printing works, then try a longer print job to make sure that serial flow control is functioning correctly.

## 4. Operation/Emulation Overview

This chapter presents an overview of the following A/C—6 (RO) emulation, printing, and configuration capabilities:

- IBM Emulation and Compatibility
- DSC and SCS Printing Modes
- Printer Drivers
- Presets
- Printer Initialization Strings
- Character Translation Tables
- Special Applications

### 4.1 IBM Emulation and Compatibility

A/C—6 (RO) supports 3270 Data Stream Compatible (DSC) and SNA Character String (SCS) operating modes. DSC mode is synonymous with bisynchronous operation or SNA operation as LU Type 3. SCS mode is synonymous with SNA operation as LU Type 1. These operating modes are dynamically set as directed by the IBM 3X74/3276 controller. When SCS mode is active, A/C—6 (RO) processes the SCS control codes and achieves the intended printout format by transmitting only standard ASCII control characters and data.

#### *Printer Emulation*

A/C—6 (RO) supports most features of an IBM 3287 printer. EBCDIC characters and printer commands which are sent from the host are translated into an async ASCII format. Conversely, printer fault conditions are reported to the host. Typically, no host software changes are required if 3287 type printers are presently supported.

You can connect the A/C—6 (RO) to the host through a cluster controller over Type A coax cable or twisted pair wire. You can connect the ASCII printer to either of A/C—6 (RO)'s ports (parallel or serial). As shown in **Figure 4-1**, your parallel printer can be shared between a PC compatible computer and the mainframe host (See *Passthrough Printing* in **Section 3.5**).

The serial interface conforms to EIA RS-232C specifications and is permanently wired for DCE (Data Communication Equipment) configuration. In DCE configuration, the output device is connected directly to the A/C—6 (RO) serial port.

The parallel output device is connected directly to the A/C—6 (RO) parallel port.

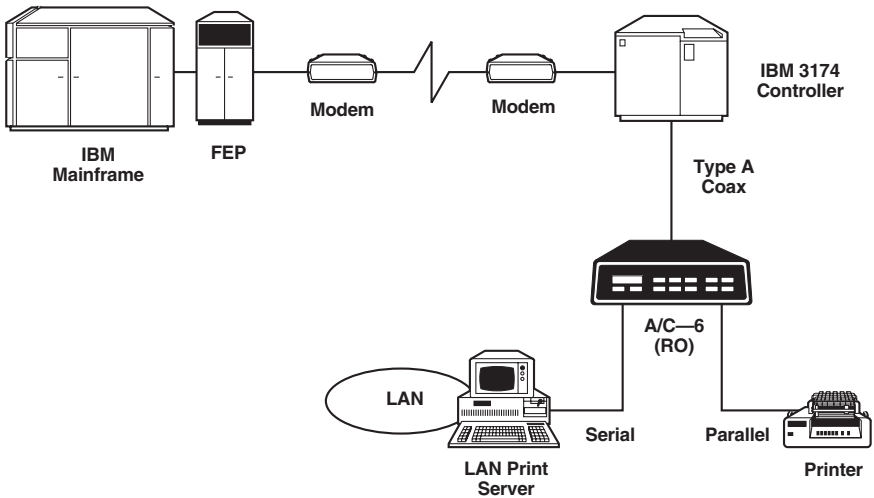

**Figure 4-1. Typical A/C—6 (RO) Configuration.**

## 4.2 DSC and SCS Printing Modes

### *DSC Mode Printing*

DSC (3270 Data Stream Compatible) Mode is the print mode used in all non-SNA systems. It is sometimes referred to as DSE (3270 Data Stream Emulation) Mode or simply 3270 Mode. All systems using remote bisynchronous data transmission protocol (BSC) use this print mode, as do channel attached non-SNA systems and printers defined as LU (Logical Unit) Type 3 in VTAM. All local copy screen print operations occur in DSC Mode, both operator-initiated and host-initiated.

### *SCS Mode Printing*

A/C—6 (RO) supports SCS (SNA Character String) Mode. SCS Mode is entered by specifying the device as an SNA Logical Unit Type 1 (LU 1) during control unit configuration. During SCS transmissions, print format is under complete control of the application.



### 4.3 Printer Drivers

A/C—6 (RO) provides printer drivers for the following printers:

- TTY (generic)
- Xerox® Diablo® 630; 4045 (2700 emulation)
- Epson® FX-80
- IBM Proprinter®
- OTC 2100 series
- C. Itoh® 300/400/600/800
- HP LaserJet series II
- Xerox 4045

#### *User-Definable Driver*

If your application requires anything other than IBM standard printer configuration values, you may customize a driver using up to 32 user-defined strings, as summarized in these steps:

1. Select a driver.
2. Customize options.
3. Select values.
4. Test print.
5. Print job.

For more detailed instructions, refer to **Appendixes B** and **C**.

### 4.4 Presets

The easiest method of configuring A/C—6 (RO) for each printer is through its front panel. After you have finished selecting the appropriate parameter values in Configuration Mode, you must save your recipe to one of eight numbered presets found in the Utilities menu.

See **Section 5.2** for step-by-step instructions on configuring from the front panel.

### 4.5 Printer Initialization Strings

Another way of configuring A/C—6 (RO) is by typing command sequences at a host display station. These pseudo-commands travel unencumbered through the host system software and communication paths to A/C—6 (RO).

One of these pseudo-commands is the printer initialization string. It is important for the correct formatting of printer sharing jobs; it can be loaded with escape sequences for the transmission of printer-character font-selection commands, page-format commands, cursor positioning, etc. It can also be used to run macros and insert separator pages, among many other tasks.

For example, if another user sends a print job through one of the ports, the text will print according to the format (text face, size, style, etc.) specified by that user. After their print job is complete and you send your print job through another port, your job may be output using the format of the previous print job, which may not conform to your specifications.

By using an initialization sequence, like ESC E, before sending your job, you can avoid undesirable print results. (ESC E resets the LaserJet printer to its front panel defaults.) Initialization strings are sent ahead of the data from your port.

When using an initialization string, the escape sequences do not have to be sent from the host with every print job. You send them once to the printer and they are stored by A/C—6 (RO).

Initialization strings are discussed further in **Section 5.2**, Option 51, Power-up Strings; Option 104, Print User String.

## 4.6 Character Translation Tables

A/C—6 (RO) provides flexible character translation to accommodate international languages, a variety of ASCII printers, and specialized applications. Individual characters can also be changed.

A/C—6 (RO) uses three types of translate tables:

1. SCS Character Translate Table (EBCDIC to internal ASCII)
2. DSC Character Translate Table (IDBCOD to internal ASCII)
3. Printer Character Translate Table (internal ASCII to printer ASCII)

The first two tables convert the host computer's language into an internal ASCII used by A/C—6 (RO). Only one of the first two tables is used, depending on which printing mode (SCS or DSC) you are using. The third table, the Printer Character Translate Table, is then used to determine the actual ASCII characters to send to the printer.

Character translation is done through the Editors menu of the A/C—6 (RO) Configuration Mode (See **Section 5.2**).

## **4.7 Special Applications**

A/C—6 (RO) facilitates such printing and graphics programs as Maersk Data's MD-GRAFTEXT, MD-LASER and ACX Software's ACX-TEND Extended Text Manager.

MD-GRAFTEXT enables users of DCF/SCRIPT the use of various fonts and the integration of text and graphics. MD-LASER allows any graphics package running on an IBM mainframe to send graphs to an IBM LaserPrinter. ACX-TEND, used with ACX-PM Printer Manager, provides centralized control of ASCII printing devices connected to asynchronous communication lines or 3270 protocol converters.

The Appendixes contains further information, including the Maersk Data Environment and preparatory commands for the laser printer, A/C—6 (RO) configuration procedures for ACX-TEND, and a sample configuration file and how to send it.

# 5. Configuration

This chapter covers:

- System Configuration, including VTAM definitions.
- Front-Panel Configuration: A/C—6 (RO) pushbuttons, configuration menus, parameters, defaults, configuration example.
- Coax Configuration Download.

## 5.1 System Configuration

Devices attached to the mainframe through a local or remote control unit are driven (receive their instructions) by special programs provided by IBM. These programs have to be customized by making entries in tables so that they will know which devices are available to them. The most common of these programs is VTAM (Virtual Telecommunications Access Method).

Refer to the following documentation for host configuration:

- *IBM Installation of VTAM V3 for VM/SPR4*
- *IBM VTAM V.3 Release/Installation and Resource Definition*

For information on how to specify 3287 to VTAM, refer to:

- *IBM Network Program Product Samples*
- *IBM VTAM Version 3 Release/Customization*

The communications controller receives data and instructions from the mainframe and must distribute this information to the various devices attached to it. To perform this task, the controller must know both the addresses (ports to which attached) and the characteristics of these devices. Again this information is stored in tables, but this time the tables are within the controller rather than the mainframe.

Refer to the following documentation for control unit configuration:

- *IBM 3274 Control Unit Description and Prog. Guide*
- *IBM 3274 Control Unit Customizing Guide*
- *IBM 3174 Control Unit Functional Description*
- *IBM 3270 Customizing Guide, Configuration Support D*

- *IBM 3174 Control Unit Customizing Guide*
- *IBM 3174 Control Unit Help Desk Reference*
- *IBM 3276 Control Unit Description and Prog. Guide*

*VTAM Definitions*

Examples of the VTAM Mode Table entries used with A/C—6 (RO) are shown below for both DSC and SCS modes. These are standard table entries which should work for any application of A/C—6 (RO).

DSC2K	MODEENT LOGMORE=DSC2K, FMPROF=X'03' TSPROF=X'03' PRIPROT=X'B1' SECPROT=X'90' COMPROT=X'3080' RUSIZES=X'8787 PSERVIC=X'030000000000185018507F00'	BIND USED FOR APPLICATION SESSIONS FUNCTION MANAGEMENT PROFILE TRANSMISSION SERVICES PROFILE PRIMARY PROTOCOL SECONDARY PROTOCOL COMMON PROTOCOL PRI RUSIZE=1024, SEC RUSIZE=1024 LU SERVICES PROFILE
DSC4K	MODEENT LOGMODE=DSC4K, FMPROF=X'03' TSPROF=X'03' PRIPROT=X'B1' SECPROT=X'90' COMPROT=X'3080' RUSIZES=X'8787' PSERVIC=X'030000000000185028507F00'	BIND USED FOR APPLICATION SESSIONS FUNCTION MANAGEMENT PROFILE TRANSMISSION SERVICES PROFILE PRIMARY PROTOCOL SECONDARY PROTOCOL COMMON PROTOCOL PRI RUSIZE=1024, SEC RUSIZE=1024 LU SERVICES PROFILE
SCSMODEENT	LOGMODE=SCS, FMPROF=X'03' TSPROF=X'03' PRIPROT=X'B1' SECPROT=X'90' COMPROT=X'3080' RUSIZES=X'87C6' PSNDPAC=X'01' SRCPAC=X'01' PSERVIC=X'01000000E100000000000000'	BIND USED FOR APPLICATION SESSIONS FUNCTION MANAGEMENT PROFILE TRANSMISSION SERVICES PROFILE PRIMARY PROTOCOL SECONDARY PROTOCOL COMMON PROTOCOL PRI RUSIZE=768, SEC RUSIZE=1024 PRIMARY SEND PACING COUNT SECONDARY RECEIVE PACING COUNT LU SERVICES PROFILE

## 5.2 Front Panel Configuration

You can input A/C—6 (RO)'s configuration commands from a PC, a host workstation or the front panel of A/C—6 (RO). Front panel configuration is the simplest method. Host and PC configuration methods are discussed later in this chapter.

See the **Appendix A** for complete descriptions of configuration K command parameters, options, defaults and examples.

### 5.2.1 CONFIGURATION PUSHBUTTONS

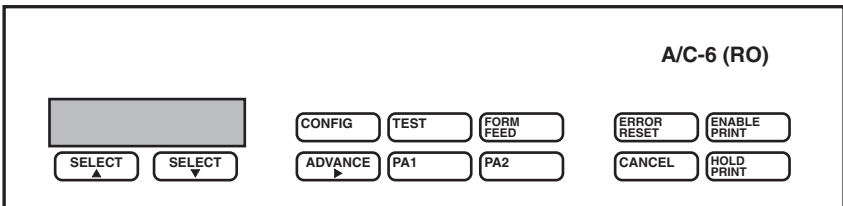

**Figure 5-1.** A/C—6 (RO) Front-Panel Pushbuttons.

The following A/C—6 (RO) pushbuttons are used in configuration:

- **CONFIG**—To enter and exit Configuration mode. After the operating parameters have been changed as required, press <Config> to exit Configuration mode and return to Hold Print mode.

Configuration mode may be exited from almost any point in the parameter menu, except during modification of a decimal parameter, as the setting must be completed before A/C—6 (RO) can store the value.

- **SELECT Up Arrow/SELECT Down Arrow**

1. To scroll from one menu to another.
2. To switch from one parameter in a menu to another. Parameters display in a circular fashion, and a different parameter appears each time Select Up or Select Down is pressed.
3. To move from one option in a parameter to another. Options display in a circular fashion, and a different option appears each time Select Up or Select Down is pressed.

4. To increment or decrement the flashing digit when configuring a decimal parameter.

- **ADVANCE Right Arrow**

1. To enter a menu. (For example, pressing ADVANCE Right Arrow at the Host Defs menu will bring up the Log Buff Size parameter.)
2. To access a parameter's options. (For example, pressing ADVANCE Right Arrow at the Log Buff Size parameter will bring up the 3440 option.)
3. To move the cursor to the next digit to the right when changing a decimal parameter.

### **5.2.2 FRONT-PANEL MENU TREES**

Front panel configuration consists of two menus (see **Figures 5-2** and **5-3**).

1. Standard configuration parameters
2. Advanced configuration parameters

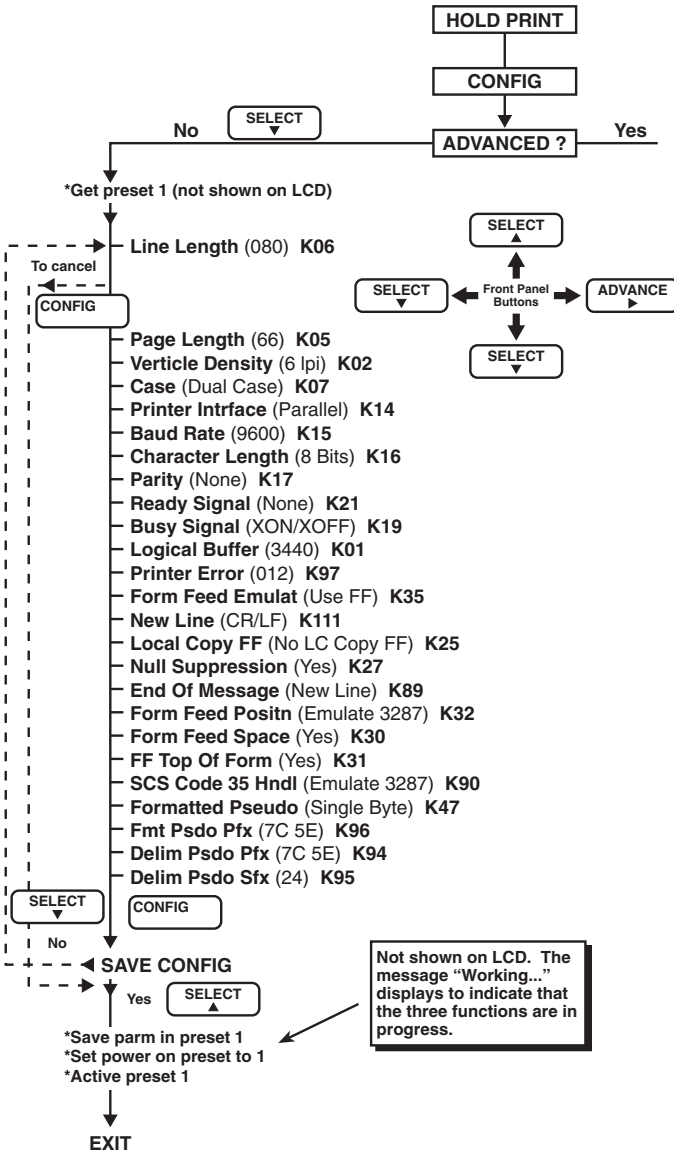
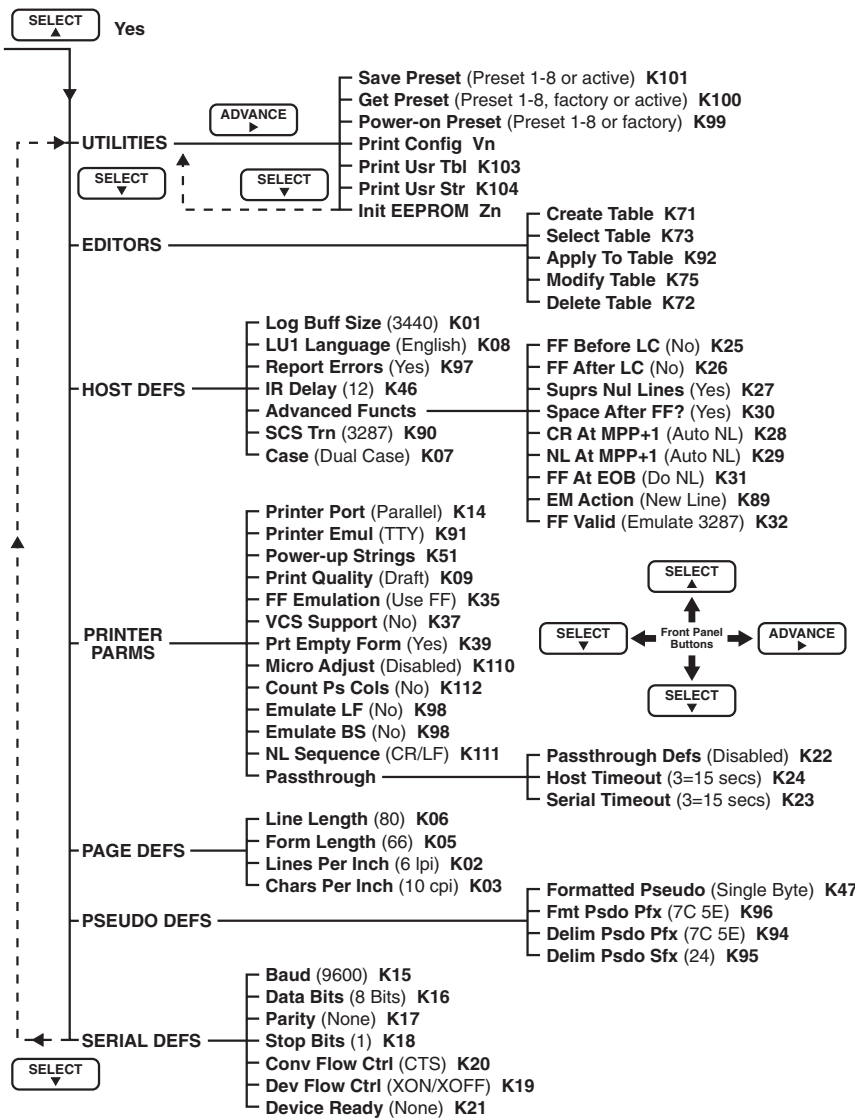

Figure 5-2. Configuration Parameters Menu—Standard.





**Figure 5-3. Configuration Parameters Menu—Advanced.**

### 5.2.3 FRONT-PANEL CONFIGURATION EXAMPLE

This is a button-by-button front panel configuration example, using the following options:

- A Diablo 630 printer connected to the parallel port.
- A PC connected to the serial port which shares the Diablo 630 with the host.
- A host timeout of 20 seconds.
- Parameter assignment to Preset 4, which will be activated whenever A/C—6 (RO) is powered on.

1. Enter configuration mode by pressing <Hold Print>, then <Config>.
2. “Advanced Config?” is displayed. Press <Select Up Arrow> to reach the Advanced Configuration parameters menus.
3. The Utilities menu is displayed. Press <Select Down Arrow> until the display reads “Printer Parm.” Press <Advance Right Arrow>.
4. Scroll with <Select Down> or <Select Up> until you reach the “Printer Emul” parameter. Press <Advance Right>.
5. Scroll with <Select Down> or <Select Up> until you reach “DIAB63.” Press <Advance Right>. You have just selected the Diablo 630 printer driver.
6. Press <Select Down> until the Passthrough submenu displays. Press <Advance Right>.
7. Press <Advance Right> again. “Disabled” appears.
8. Use <Select Down> or <Select Up> to choose “Enabled” or “Disabled.” Press <Advance Right> to confirm your choice.
9. Press <Select Down> until you see “Host Timeout.” Press <Advance Right>. Press <Advance Right> again to move to the rightmost digit.
10. Use <Select Up> to change the value to 4. (Four five-second intervals equals a host timeout value of 20 seconds.) Press <Advance Right>.
11. Press <Select Down> until you reach “Printer Parm” again.
12. Scroll with <Select Down> or <Select Up> until you reach the Utilities menu. Press <Advance Right>. The “Save Preset” parameter appears.
13. Press <Advance Right>, then <Select Up> until Preset 4 appears. Press <Advance Right> to select it.

You have just written your changes to A/C—6 (RO)'s EEPROM chip under configuration preset 4. If you wish your settings to be active at every startup, locate the Power-on Preset parameter (also in Utilities) and change it to Preset 4. Press <Advance Right> to confirm the change.

### CAUTION

**When you have finished configuring A/C—6 (RO), you must save your changes to one of the eight EEPROM presets in the Utilities menu.**

**Pressing Config at any time during configuration causes A/C—6 (RO) to exit configuration mode and save your changes to the active area only. This means that your changes will not be retained when A/C—6 (RO) is powered off.**

#### 5.2.4 FRONT-PANEL MENUS, PARAMETERS AND OPTIONS

##### *Utilities Menu*

- *Save Preset (K101)*—Once you have successfully defined all the configuration parameters for a certain printer or system, use this utility to save the values you selected to one of eight numbered presets. If you exit configuration mode without using this utility, your changes will be lost when A/C—6 (RO) is powered off.
- *Get Preset (K100)*—Use this utility to retrieve and modify any of the eight presets you may have saved with the Save Preset utility. Options are Preset 1 through 8, factory default-configuration values, and active.
- *Power-on Preset (K99)*—This utility selects the configuration preset which will be active when A/C—6 (RO) is powered on. Options are Preset 1 through 8 and factory-default values.
- *The Print commands*—These three utilities allow you to review internally stored information from a hard copy. When you press ADVANCE Right Arrow at the appropriate display, A/C—6 (RO) will print:
  - *Print Config*—Parameter settings for all presets.
  - *Print User Table (K103)*—One of the user-defined character translation tables (see the Technical Reference).
  - *Print User String (K104)*—One of the user-defined command strings.
- *Initialize EEPROM*—This command returns the EEPROM completely to the values which were set in the factory, erasing all user-defined strings, presets and other modifications. Use this command only if it is your intention to clear all previous user modifications.

### *Editors Menu (K71, K73, K92, K75, K72)*

The Editors Menu consists of five editing functions which have to do with character-translation tables. Please refer to the A/C—6 (RO) Technical Reference if you intend to modify individual character translations.

### *Host Definitions Menu*

- *Logical Buffer Size (K01)*—Defines the memory storage available for each print. Buffer size must be defined larger than or equal to that required for print requests. Options are 1920, 2560, 3440, and 3564 characters. The default is 3440.

In SNA systems, when a bind is received, buffer size is compared with that specified in the bind parameters. A bind will be accepted if the buffer size is equal to or larger than that requested.

In non-SNA systems, including local copy, any value may be used.

- *LU1 Language (K108)*—Defines the language for SCS (SNA LU Type 1) printing. This option is not used in DSC Mode printing. See the Technical Reference for the character changes for each country. Choose the same language number which was used in configuring the IBM control unit. The default is English (U.S.).
- *Report Errors (K97)*—Defines whether or not A/C—6 (RO) error messages are to be printed. If Report Errors is set to No, errors will be ignored and no indication of their occurrence will be given to the operator. The default is Yes.

Error messages may include self-test failure messages, special A/C—6 (RO) command stream error messages and hex transfer data stream error messages.

- *IR Delay (K46)*—Defines the printer not ready error timeout period during host printing. Any time host printing is occurring, if the printer runs out of paper, etc., the timer will be started. If the time expires before the printer is restored, an Intervention Required (IR) error is sent to the host. Time is specified in 5-second intervals. Values can range from 0 to 255 (up to approximately 20 minutes). The default is 12 (one minute).

### *Advanced Functions (DSC) Submenu*

Advanced functions is a submenu consisting of nine DSC mode parameters. If you are printing in a non-DSC mode, you may disregard this submenu.

- *Form Feed Before Local Copy (K25)*—Specifies whether or not a form-feed command is to be sent to the printer before a local copy print. The default is No.

- *Form Feed After Local Copy (K26)*—Specifies whether or not a form feed command is to be sent to the printer after a local copy print. The default is No.
- *Suppress Null Lines (K27)*—Specifies whether null lines are to be suppressed and discarded or whether they are to be printed as blank lines. Null lines are those which contain no printable characters. They are made up entirely of attributes, nulls, and non-display fields. The default is Yes.
- *Space After Form Feed (K30)*—Specifies whether or not a blank space will appear in your printout in the first print position of the next form following a DSC form feed. Normally, on an IBM printer operating in DSC mode, the top line of each new form is missing the leftmost character position. This position held the form feed command in the host data stream. For 3287 compatibility, the default is Yes. To regain the print position taken up by the blank space, set this option to No.
- *CR at MPP + 1 (K28)*—Specifies whether or not to generate an automatic new line if a carriage return is found at the Maximum Print Position plus 1. Default is Auto NL.
- *NL at MPP + 1 (K29)*—Specifies whether or not to generate an automatic new line if a new line is encountered at the Maximum Print Position plus 1. Default is Auto NL.
- *FF at EOB (K31)*—Form Feed at End of Buffer. Defines the action when a form feed is the last character in an unformatted DSC print buffer. Toggles Automatic New Line—on and off. The default is Do NL.
- *EM Action (K89)*—Specifies the action to be taken at the end of each unformatted DSC mode print. If the printer is already at the beginning of the new line or new form, the automatic NL or FF is suppressed.

Options are New Line, Form Feed, or Nothing. By setting this option to Nothing, printouts spanning buffers can be allowed to continue on the same line with the next print position. The default is New Line.

- *FF Valid (K32)*—Specifies when a form feed will be considered valid in a print line. Normally, on all IBM printers operating in DSC mode, a form feed command is restricted to the first position of a print line. If a form feed is received anywhere else, it is considered invalid and ignored. Changing this option to Anywhere allows a form feed command to be accepted at any location in the data. The default is Emulate 3287.
- *SCS Transparency (K90)*—Specifies how transparent data sent using SCS code 35 is to be handled. If set to 3287 (default), valid graphics characters are printed normally (that is, converted from EBCDIC to ASCII), control codes and invalid graphics are printed as hyphens and normal page formatting is maintained.

If set to Transparent, this special handling is disabled. The 8-bit binary codes are sent by A/C—6 (RO) just as they are received.

- *Case (K07)*—Defines whether or not characters are to be printed in capital letters only. Mono Case converts all lowercase characters to uppercase. Dual Case (default) allows characters to be printed as received from the host without conversion.

### *Printer Parameters Menu*

- *Printer Port (K14)*—Selects the ASCII port on the back panel of A/C—6 (RO) which will be connected to your printer. The choices are Parallel (default) and Serial. The parallel interface is Centronics protocol. See **Appendix I** for interface specifications.
- *Printer Emulation (K91)*—Selects the firmware driver which matches your printer's make and mode. See the Technical Reference for further details on printer drivers. The default is TTY, a generic printer driver.
- *Power-up Strings (K51)*—Selects the user-defined command strings which are to be sent to the printer at every startup. See **Appendix E** for more information on transparent data transfer.
- *Print Quality (K09)*—Selects between draft (default) and near letter quality for dot-matrix printers such as the IBM Proprinter. See the Technical Reference to determine which setting (Draft or Letter Quality) is best for your particular printer.
- *FF Emulation (K35)*—Defines the control code(s) sent to the printer to enable form feeds. When a form-feed command is received from the host, either a single form feed will be sent (default) or line feeds will be sent for each of the lines left on the current page. The lines-per-page number used in counting line feeds is specified using the Form Length parameter (Page Definitions menu).

The default is Use FF. If the form length to be used is smaller than the physical page and is an even multiple of it, choose Use LFs to send line feeds in place of form feeds. An example of this would be a label-printing application.

- *VCS Support (K37)*—Defines what will be sent to the printer when a Vertical Channel Select (VCS) command is received. If VCS Support is set to No (default), one line feed will be sent. If it is set to Yes, the printer will be sent the number of line feeds required to advance to the vertical channel specified. The vertical channels are set by the SHF command.
- *Print Empty Form (K39)*—Specifies whether or not to suppress blank printout pages. If Print Empty Form is set to Yes (default), all Form Feed commands that would result in blank pages are ignored. Form Feed commands are ignored if received when positioned at the top of a form.

Options are Yes or No.

- *Micro Adjust (K110)*—When this option is Enabled, an overstrike effect will be emulated to support applications that rely on this effect to make text boldface.

This option must be Disabled (default) when using Counted or Single Byte Hex Transfer Mode.

- *Count Pseudo Columns (K112)*—If this option is set to No (default), A/C—6 (RO) will not count pseudo-characters as columns (that is, pseudo-characters will not affect column count). If it is set to Yes, pseudo-characters will be included in the column count.
- *Emulate LF (K98)*—Specifies how the SCS Line Feed (LF) should be handled. Options are No (default) and Yes.
- *Emulate BS (K98)*—Specifies how the SCS Backspace (BS) should be handled. Options are No (default) and Yes.
- *Newline Sequence (K111)*—Some printers require the Newline Sequence in a particular order. If your printer is performing the carriage-return/line-feed sequence incorrectly, refer to your printer's documentation to determine in which order A/C—6 (RO) should send these commands. Options are None, CR, LF, CR/LF (default), or LF/CR.

### *Passthrough*

- *Passthrough Defs (K22)*—This option defines whether or not data can be received on the serial port and passed to the parallel port. If you wish to enable passthrough, the parallel port must be made the active interface (Option K14). Options are Enabled or Disabled (default).
- *Host Timeout (K24)*—This option defines the amount of time that A/C—6 (RO) will wait before servicing the async passthrough port after processing a coax print job. Time is specified in 5-second intervals. Values can range from 1 to 255 (up to approximately 20 minutes). The default is 3 (15 seconds).
- *Serial Timeout (K23)*—This option defines the amount of time that A/C—6 (RO) will wait before servicing the serial passthrough port after processing a coax print job. Time is specified in 5-second intervals. Values can range from 1 to 255 (up to approximately 20 minutes). The default is 3 (15 seconds).

### *Page Definitions Menu*

- *Line Length (K06)*—Also known as Page Width, this option defines the maximum number of characters which can be printed on each line. Values are between 0 and 255 characters across. The default is column 80.

- *Form Length (K05)*—Also known as Page Length, this option defines the maximum number of vertical lines which can be printed on each form. Values are between 0 and 127 lines per page. The default is 66 lines.
- *Lines Per Inch (K02)*—Also known as Vertical Density, this option defines the vertical spacing between print lines. This option affects the maximum number of print lines on a page. For 3 and 4 lines per inch, double spacing is used and a blank line appears between each print line. Options are 3, 4, 6 (default) and 8 lpi.
- *Characters Per Inch (K03)*—Also known as Horizontal Density, this option defines the horizontal spacing between characters. This option affects the maximum number of characters on a line. Options are 10 (default), 12, 15 and 16 cpi.

### *Pseudo Definitions Menu*

The parameters in this menu are for use with transparent data transfer (see **Appendix E**).

- *Formatted Pseudo (K47)*—Specifies whether the data following the Formatted Hex Transfer Prefix is in Single Byte (default) or Counted.
- *Formatted Pseudo Prefix (K96)*—Allows creation of a customized trigger character or string of characters to indicate that Formatted Hex Transfer Single Byte or Counted Mode Data follows. A string of up to eight characters may be defined. Choose a sequence that is unique (that is, one that does not occur in normal print data).
- *Delimited Pseudo Prefix (K94)*—Allows creation of a customized trigger character or string of characters to indicate that Delimited Hex Transfer Mode data follows. A string of up to eight characters may be defined. Choose a sequence that is unique (that is, one that does not occur in normal print data).
- *Delimited Pseudo Suffix (K95)*—Allows creation of a customized trigger character to indicate the termination of Delimited Hex Transfer Mode data.

### *Serial Definitions Menu*

Use this menu to configure all the parameters for connection of a printer or PC to the A/C—6 (RO) serial port. Serial Parameters are in effect whether or not passthrough printing is enabled.

- *Baud (K15)*—The speed, in bits per second, at which the serial port will accept data transmission. Bit rate must be set to match the attached device and modem, if applicable. Valid options are 38400, 19200, 9600 (default), 4800, 2400, 1200, 600, 300, 110, and 75 bps.



- *Data Bits (K16)*—This parameter defines character length in bits per character. Valid character lengths are 7 and 8 (default).
- *Parity (K17)*—Must be set to match the parity, if any, of the connected device. Valid choices are Even, Odd, or None (default).
- *Stop Bits (K18)*—This parameter defines the number of stop bits per character. Valid entries are 1 (default) and 2.
- *Converter Flow Control (K20)*—This parameter defines which interface pin will be used by A/C—6 (RO) to assert flow control on the device attached to the serial port. This parameter is in effect only during passthrough printing. If the device does not accept this type of signaling, select XON/XOFF. Valid options are:

None

XON/XOFF

CTS (default)

DSR

- *Device Flow Control (K19)*—This parameter defines which interface pin will be used by A/C—6 (RO) to determine if flow control has been asserted by the device attached to the serial port. If the device does not accept this type of signaling, select XON/OFF. Valid options are:

None

XON/XOFF (default)

DTR

RTS

Pin 11 low

Pin 11 high

- *Device Ready (K21)*—This parameter defines which interface pin will be used by A/C—6 (RO) to determine if the device attached to the serial port is on-line and ready to receive data. If the device does not accept this type of signaling, select None. Valid options are:

None (default)

DTR

RTS

Pin 11 high

Pin 11 low

### 5.3 Coax Configuration Download

Another way to configure A/C—6 (RO) is to send command sequences from the host. Host configuration download is implemented by sending commands that consist of displayable text characters. These special commands are recognized and acted on only by A/C—6 (RO).

The format of the download has been designed to be as simple as possible. It allows you to create the configuration file using any standard text editor on the host. The configuration file can also be created by typing it on the screen and sending it with the <Print Screen> key, if local-copy screen printing is enabled in the control unit's Printer Authorization Matrix (PAM).

*A/C—6 (RO) Configuration Command Format*

*Configuration Option Command Format Trigger K NN , nn Trigger*

- Trigger = Start of command (user-defined)
- K = Command-type character
- NN = Option code number
- , = Comma required between fields
- nn = Option change value number or hex character
- Trigger = End of command (user-defined)

In addition to the K Configuration Option command, other commands are identified by the following trigger-character introduction sequences:

- Trigger Xn = CONFIGURATION DATA SAVE/RECALL
- Trigger Zn = SEND PRINTER INITIALIZATION STRING
- Trigger Vn = PRINT PRESET

The n specifies a parameter number. These commands are not terminated with a trigger character.

The active configuration is contained in RAM. If changes are made to the factory default, these will be temporary unless the command is issued to store to EEPROM.

*Defining a Trigger Character*      &&??<character>

Before you can change options, you must define a temporary trigger character. The trigger is a single, printable character other than a space character that you select to start and end configuration strings. The trigger character stays in effect until cleared, A/C—6 (RO) is powered off or a new trigger character is defined.

The sequence below defines the % character as the trigger character.

**&&??%**

The initial &&?? must be contiguous except when separated by a host buffer boundary. If &&?? is followed by an illegal (non-printable) character, A/C—6 (RO) will accept the first subsequent legal character.

*Clearing the Trigger Character*      **&&??<space>**

After changing options, the trigger should be cleared. Clear the trigger by sending the &&?? trigger sequence followed by a space.

The trigger-clear sequence must be sent exactly as shown below without spaces within the first four characters or other intervening characters.

**&&??<space>**

A test print displays the currently defined trigger character.

## **NOTE**

**In some host systems, the print spooler will truncate spaces at the end of a record. Therefore, when NL, CR and FF immediately follow the &&??<space>, they also serve to clear the trigger character. To be sure that the space character is not deleted, a character should follow this sequence if it is inserted into a file to be printed from the host. Because any printable character will appear in the listing, a non-printable character (FF, BEL, etc.) is recommended for use.**

*Changing Options*      **Knn,nn...**

After a trigger character has been defined, any setting of the A/C—6 (RO) configuration options may be changed.

Send configuration commands in the format shown in the Technical Reference. Locate the option code number and the option change value number for each option to be changed.

After the options have been modified, verify the changes and store them permanently if desired by using the procedures on the following pages.

## NOTE

In all commands other than the trigger-definition command, all spaces, commas and format control characters (such as NL and FF) are ignored. Spaces, commas or NLS may be inserted within these commands to make them more legible.

While most option changes take effect immediately, some do not. Some changes need to be reported to the IBM control unit before taking effect.

For example, page-format options can be changed to accommodate different print applications or to print some applications using different languages.

Defining a new trigger character provides access to all of the options at any time. Below is an example of how options could be changed at any time after installation. All necessary steps are shown.

### *Procedure for Changing Options*

1. Define a trigger character
2. Get Preset 0 (Defaults)
3. Change options to desired settings
4. Save changes to Preset 1
5. Activate Preset 1
6. Clear the trigger character

As the individual commands would appear:

**&&??%**—Define % as trigger character

**%K100,0%**—Get factory-default options (Preset 0) into work area

**%K08,7%**—Set Option 08 = 7

**%K35,1%**—Set Option 35 = 1

**%K101,1%**—Save work area changes to Preset 1

**%K102,1%**—Activate Preset 1

**&&??<Space>**—Clear trigger character

As they might appear on a terminal screen:

&&??% K100,0%% K08,7%% K35,1%% K101,1%% K102,1%&&??  
(then a space)

% represents the defined trigger character.

### NOTE

**In some cases Y may be used instead of K as the command-type character. Any differences will be noted under the individual option command. Options 01-19 and Options 25-47 accept Y or K as the command-type character.**

**In those instances where Y is not supported but is received, A/C—6 (RO) will ignore the command and all characters up to and including the end-of-command character.**

### *Verifying Changes*

To confirm option setting changes, use the front-panel controls to obtain a copy of the current option values.

To print the test print:

- Take A/C—6 (RO) off-line by pressing <Hold Print>.
- Use the <+> button to locate the PRCFG soft key. Press the arrow key beneath the display to start the test print.

Within a few seconds two pages will be ejected. Verify that these option settings are the ones intended.

### *Moving Configuration Data*

Configuration data save/recall commands (e.g., X1, X3, X4) can take on several values in order to move configuration data between memory locations on A/C—6 (RO).

X1 = RAM to EEPROM—Make Changes Permanent

X3 = ROM to RAM—Recall Default Options

X4 = EEPROM to RAM—Recall Permanent Options

The active configuration is in RAM. The factory defaults are in ROM. The saved configuration is in EEPROM (non-volatile memory).

These commands are explained in detail in the following three sections.

## CAUTION

**Unnecessary use of the Save commands (e.g., Option 101, SAVE PRESET) will cause the EEPROM to prematurely wear out after 10,000 writes. To make the most efficient use of these commands, please follow the recommendations given in the SPECIAL NOTE below.**

*Making Changes Permanent*

*%X1*

Initially, all changes are made only in RAM. When power is turned off, these changes are lost. Changes can be saved permanently by sending the X1 command, MAKE CHANGES PERMANENT. Permanent changes are stored in non-volatile memory, retained whenever power is turned off and restored from non-volatile memory each time power is turned on.

To make the current set of temporary changes permanent, send the following sequence:

*% X 1*

## NOTE

**The X1 command permanently saves all user strings and all translate tables.**

**In addition, use of the X1 command also affects Preset 1. For example, if changes are made to the active preset and followed by the X1 command, those values will overwrite the contents of Preset 1.**

## SPECIAL NOTE

**To avoid unnecessary writes to EEPROM, the X1 command, MAKE CHANGES PERMANENT, should be used only during setup and initialization of the printer for your application. If you are alternating between two different applications (for example, portrait and landscape on the HP LaserJet printer), define a preset for each and then change to the alternate application by using Option 100, GET PRESET.**

*Recalling the Default Settings*

*%X3*

Default settings originally programmed at the factory can be recalled. For example, if incorrect option changes have been stored permanently by mistake, neither the current option settings nor the permanent option settings may be usable. To correct this, commands could be sent to reset each individual option, or the X3 command, RECALL DEFAULT OPTIONS, could be sent, followed by any necessary individual option changes.

To recall the original factory-default option settings, send the following sequence: % X 3.

## NOTE

**%** represents the defined trigger character.

The X3 command effectively restores all the global options (user strings and translate tables) but only to Preset 1. Option 100, GET PRESET, and Option 101, SAVE PRESET, ensure that all the other presets are reset to the factory defaults. See Option 100 and Option 101 in the A/C—6 (RO) Technical Reference.

**&&??%** —Define % as trigger character

**%X3**—Recall defaults

**%X1**—Make changes permanent

**%K100,0%**—Copy defaults to work area

**%K101,1%**—Save defaults to Preset 1

**%K101,2%**—Save defaults to Preset 2

**%K101,3%**—Save defaults to Preset 3

**%K101,4%**—Save defaults to Preset 4

**%K101,5%**—Save defaults to Preset 5

**%K101,6%**—Save defaults to Preset 6

**%K101,7%**—Save defaults to Preset 7

**%K101,8%**—Save defaults to Preset 8

**&&??<Space>**—Clear trigger character

*Recalling the Permanent Settings*                      %X4

At times it may be necessary to recall the permanent option settings by sending the X4 command, RECALL PERMANENT OPTIONS—for example, if temporary changes have been made and you cannot power off and then power on A/C—6 (RO).

To recall the settings held in permanent storage, send the following sequence:

% X 4

## NOTES

**%** represents the defined trigger character.

**%X4** will recall the options defined by the power-up preset and the permanent user strings and translate tables.

### *Option Change Exceptions*

Some option changes must be indicated to the IBM control unit. Changes to the options below do not take effect until A/C—6 (RO) is power-cycled while connected to the control unit. This is unlike all other option changes, which take effect immediately.

### *Option Changes Which Must Be Reported*

- Option 01—LOGICAL BUFFER SIZE—any change
- Option 08—LU1 LANGUAGE—Request Language Download (00)



## 6. Operation

This chapter describes the actions of A/C—6 (RO) in two modes:

1. On-line (Enable Print). All printing from the host occurs in this mode.
2. Off-line (Hold Print). This mode is used to stop the printout in order to clear a ribbon jam, to replace the forms, mark the new top of form, etc.

In each of these modes, some pushbuttons are active while others are not.

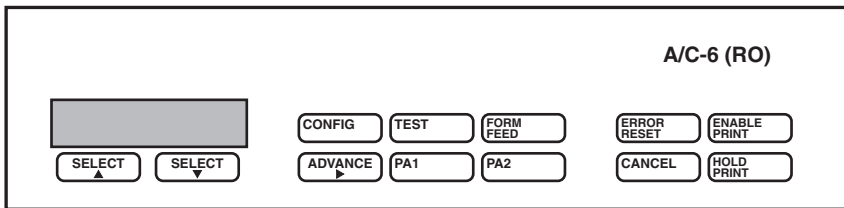

**Figure 6-1. A/C—6 (RO) Front Panel Controls.**

- *CONFIG*—Used in off-line mode (Hold Print) to switch A/C—6 (RO) into and out of configuration mode.
- *TEST*—Used in off-line mode (Hold Print) to start and stop the test printout.
- *FORM FEED*—Used in off-line mode (Hold Print) to advance paper to the top of the form.
- *ERROR RESET*—Clears an error message.
- *ENABLE PRINT*—Allows A/C—6 (RO) to accept print jobs.
- *HOLD PRINT*—Takes the printer off-line, thereby restricting A/C—6 (RO) from accepting print jobs.
- *CANCEL*—Used in off-line mode (Hold Print) when in SCS mode to terminate the current printout.
- *PA1, PA2*—Active in off-line mode (Hold Print) when in SCS mode only. Pressing PA1 or PA2 in SCS mode will cause the corresponding key code to be sent to the host. The host response depends on the application.
- *ADVANCE Right Arrow*—Used in off-line mode (Hold Print) to output the

displayed Setup string. Used in Configuration mode to enter a menu to access its parameters.

- *SELECT Down Arrow*—Used in off-line mode (Hold Print) to select the next Setup string. Used in Configuration mode to enter the Standard Configuration Menu and to select the next parameter.
- *SELECT Up Arrow*—Used in off-line mode (Hold Print) to select the previous Setup string. Used in Configuration mode to enter the Advanced Configuration Menu and to select the previous parameter.

## 6.1 On-Line Mode (Enable Print)

When A/C—6 (RO) is first powered up it is in an on-line, or print-enabled, state. The LCD displays its main status screen. By pressing SELECT Down Arrow, you can scroll through six different displays. **Figure 6-2** illustrates the progression.

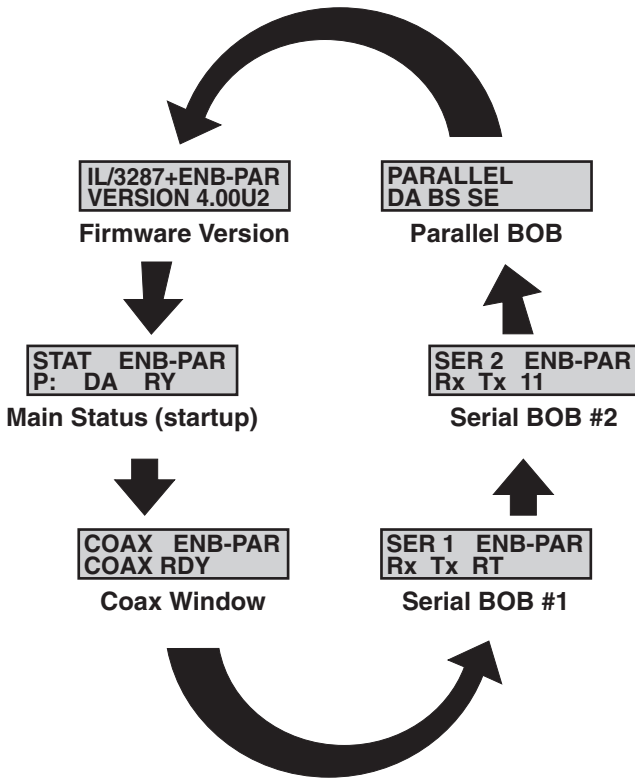

**Figure 6-2.** On-line (Enable Print) LCD Displays.

### *Main Status Display*

This window appears whenever A/C—6 (RO) is powered up. This display will include either a P, indicating the parallel port, or an S, indicating that the display reflects the status of the serial port.

There are five possible display combinations:

- *DA RY*—Data Flow, Printer Ready. There is data flow between A/C—6 (RO) and the device, and the printer is sending a Device Ready signal. This is the normal printing status.
- *DA ER*—Data Flow, Printer Error. There is data flow between A/C—6 (RO) and the device, but the printer is not ready to print. Make sure the printer has paper and is on-line.
- *ER*—Printer Error (No Data Flow). There is no data flow between A/C—6 (RO) and the device and the printer is not ready to print. Make sure the printer has paper, etc.
- *No DR*—No Device Ready. A/C—6 (RO) is not receiving any signals from the printer. Make sure the printer is properly connected and powered on.
- *RY*—Printer Ready (No Data Flow). The printer is ready to print, but no data is currently flowing between A/C—6 (RO) and the printer.

### *Coax Window*

This display indicates coax line status. If A/C—6 (RO) is receiving polls from the control unit it will display RDY. If no polls have been received after one minute, A/C—6 (RO) displays a COAX INACTIVE message.

### *Break Out Boxes*

These three boxes function as a troubleshooting tool. Physical cable lines are represented by two-letter identifiers. If a line is held high (+12V), the LCD will display its identifier. If a line is held low (12V), the LCD will not contain its identifier.

#### *Serial Break Out Box #1, +*

- Rx—Data to printer
- RT—RTS, pin 4
- CT—CTS, pin 5
- Tx—Data from printer or PC
- DT—DTR, pin 20

*Serial Break Out Box #2, +*

- Rx—Data to printer
- 11—Pin 11
- DC—DCD, pin 8
- Tx—Data from printer or PC
- DS—DSR, pin 6

*Parallel Break Out Box, +*

- DA—Data to printer
- SE—Select
- FL—Fault (will display on printer fault)
- BS—Busy
- PE—Paper End

## 6.2 Off-Line Mode (Hold Print)

Off-line mode (Hold Print) is used to perform off-line functions such as installing new printer forms, setting top-of-form, requesting buffer reprint, etc. Off-line mode is entered by pressing HOLD PRINT.

When A/C—6 (RO) is taken off-line (Hold Print), a Unit Not Available message will be reported to the host. If no other keys are pressed within ten minutes, A/C—6 (RO) will return to an on-line state.

If HOLD PRINT is pressed while printing is active, output data transfer is stopped immediately. Printing will stop as soon as the printer empties its buffer. Printing will resume with the next character when you switch back to on-line mode (Enable Print) as long as no off-line Hold Print functions (such as a Test print or reconfiguration) were performed.

Activating any off-line Hold Print functions while an on-line print is interrupted will cause lost data. Activating the Configurator while an on-line print is interrupted will cause the print to abort.

In order to switch from off-line mode back to on-line mode, the printer must be in the Ready state. If the printer is Not Ready, A/C—6 (RO) will remain in Hold Print until the printer is made Ready.

# Appendix A: Configuration Option Commands

This appendix contains the configuration option commands listed in **Section 5.2, Front Panel Configuration**. The following advanced configuration options are listed below. You can access them through the front panel configurator.

**Table A-1. Advanced Configuration Options.**

K 01	Logical Buffer Size
K 02	Vertical Line Density
K 03	Horizontal Print Density
K 05	Form Length
K 06	Line Length
K 07	Dual Case
K 08	LU1 Language
K 09	Print Quality
K 14	Printer Interface
K 15	Baud Rate
K 16	Character Length

**Table A-1. Advanced Configuration Options.**

K 17	Parity
K 18	Stop Bits
K 19	Flow Control From Printer
K 20	Flow Control To Passthrough Device
K 21	Serial Printer Ready Indicator
K 22	Serial To Parallel Passthrough Enabled
K 23	Serial Passthrough Timeout
K 24	Host Passthrough Timeout
K 25	Form Feed Before Local Copy
K 26	Form Feed After Local Copy
K 27	Print Null Lines
K 28	Suppress Auto NL If CR At MPP + 1
K 29	Suppress Auto NL If NL At MPP + 1
K 30	Suppress Space Following Form Feed
K 31	Suppress NL If FF At End Of Buffer
K 32	Execute Form Feed Whenever Encountered

**Table A-1 (continued). Advanced Configuration Options.**

K 35	Emulate Form Feed
K 37	Vertical Channel Select Supported
K 39	Suppress Empty Forms
K 46	Intervention Required Signal Delay
K 47	Formatted Hex Transfer Select
K 51	Send Initialization Strings at Power-on
K 61	User Initialization String
K 71	Create Translate Table
K 72	Delete Translate Table
K 73	Select Translate Table
K 75	Overwrite Translate Table
K 89	Unformatted DSC Modem EM Handling
K 90	SCS TRN Translate
K 91	ASCII Printer Driver
K 92	Printer Character Translate Table
K 94	Delimited Hex Transfer String Prefix

**Table A-1 (continued). Advanced Configuration Options.**

K 95	Delimited Hex Transfer String Prefix
K 96	Formatted Hex Transfer Prefix
K 97	Enable Local Error Reporting
K 98	Line Feed And/Or Backspace Emulation
K 99	Power-On Preset
K 100	Get Preset
K 101	Save Preset
K 102	Activate Preset
K 103	Print Translate Table
K 104	Print User Initialization String
K 110	Micro Adjust Enabled
K 111	New Line Sequence
K 112	Count Pseudo-Transparency
K 113	Translate Nulls
K 114	Eject Last Page



**LOGICAL BUFFER SIZE**                    % K 01, value %

<b>Options</b>	<b>Values</b>
1920 characters	2
2560 characters	3
3440 characters	4 *Default
3564 characters	5

Defines the memory storage available for each print. Buffer size must be defined larger than or equal to that required for print requests.

In SNA systems, when a bind is received, buffer size is compared against that specified in the bind parameters. A bind will be accepted if the buffer size is equal to or larger than that requested.

In non-SNA systems, including local copy, any value may be used. IBM terminal model numbers correspond to the values used in this option: 1920 character screen size is model 2, and 3564 character screen size is model 5.

EXAMPLE: %K01,5%  
                   Changes buffer size to 3564.

**NOTE**

**Changes to this option must be reported to the IBM control unit. Follow the procedure in Section 5.3, Option Change Exceptions.**

Y may be used instead of K for this option.

EXAMPLE: %Y01,3%  
                   Changes buffer size to 2560.

**LINES PER INCH**                    % K 02, value %

Options	Values
3 lines per inch	3
4 lines per inch	4
6 lines per inch	6 *Default
8 lines per inch	8

This option defines the vertical spacing between print lines and affects the maximum number of print lines on a page.

Lines Per Inch may be used to change the vertical printing density from 6 lines per inch to 8 lines per inch, which results in a denser print image. The printer must also be capable of printing at 8 LPI, and must either be set independently or through use of the Extended Configuration optional LPI setup strings. When used in conjunction with double spacing, 8 LPI results in a print density of 4 lines per inch, while 6 LPI results in 3 lines per inch.

For 3 and 4 lines per inch, double spacing is used and a blank line appears between each print line.

EXAMPLE: %K02,8%  
Changes to 8 lines per inch.

Y may be used instead of K for this option.

EXAMPLE: %Y02,4%  
Changes to 4 lines per inch.

**CHARACTERS PER INCH**      % K 03, value %

<b>Options</b>	<b>Values</b>
10 characters per inch	10 *Default
12 characters per inch	12
15 characters per inch	15
16 characters per inch	16

This option defines the horizontal spacing between print characters. This option affects the maximum number of characters on a line.

EXAMPLE:     %K03,12%  
Changes to 12 characters per inch.

### **NOTE**

**Y may be used instead of K for this option.**

EXAMPLE:     %Y03,15%  
Changes to 15 characters per inch.

**FORM LENGTH**        % K 05, value %

<b>Options</b>	<b>Values</b>
Maximum no. of lines per form	0-255 66 *Default

Also known as Page Length, this option defines the maximum number of vertical lines which can be printed on each page. It represents the physical page length to be considered when handling SCS-mode format-control commands.

Form Length also determines the number of line feeds to output when A/C-6 (RO) is configured to perform form-feed command emulation (FORM FEED EMULATION=LINE FEEDS) and a form-feed command is received from an application or the front panel. Specifying a page length of zero causes A/C-6 (RO) to act as though page length=1. Form Length is the same as the IBM option MPL, Maximum Print Lines. This number must not be greater than the number of vertical print lines available on the physical page.

EXAMPLE:     %K05,88%  
                  Changes form length to 88 lines.

## NOTE

**When setting this option, consider Option 02, LINES PER INCH, and the font you are using. Printing beyond the physical print boundary of a page can result in lost data.**

Y may be used instead of K for this option.

EXAMPLE: %Y05,72%

**LINE LENGTH                    % K 06, value %**

### Options

### Values

Maximum no. of characters per line

0-255

80 \*Default

Also known as Page Width, this option defines the maximum number of characters or columns that can be printed in each horizontal line. IBM 3287 rules for new line insertion are emulated in both Unformatted DSC mode and SCS mode. Line Length is the same as the IBM option MPP, Maximum Print Position. This number must not be greater than the number of horizontal print positions available on the physical page.

Line Length represents the physical carriage width of the attached device, and defines when and if New Line codes (NL) are to be automatically inserted in the data stream. Attempts to print past the position defined by Line Length cause a New Line code to be automatically generated and sent to the printer. When Line Length is set to zero, A/C-6 (RO) is prevented from inserting automatic new lines, and the maximum print position becomes completely controlled by the application program; however, automatic controls at the end of the buffer are still performed. See **Option 89, EM ACTION**, in this section.

EXAMPLE:        %K06,132%  
Changes line length to 132.

                  %K06,0%  
Sets line length to zero. (Never generate automatic New Line codes.)

### NOTE

**Y may be used instead of K for this option.**

EXAMPLE:        %Y06,66%  
Changes line length to 66.

**CASE**                        % K 07, value %

<b>Options</b>	<b>Values</b>
Mono case	0
Dual case	1 *Default

This parameter allows the options of upper case only (mono) or both upper and lower case (dual) printing. User-selectable print case is effective only in DSC mode and does not affect output in either SCS or Test mode. It acts by either converting lower-case characters to upper case, or passing all characters as is. To perform lower-case printing, the printout device must have a lower-case font installed.

If you choose Mono Case (upper case only), all lower-case characters are converted to upper case. Choosing Dual Case allows characters to be printed as received from the host without conversion.

EXAMPLE:        %K07,0%  
Changes to upper case only.

**NOTE**

This option affects DSC Mode printing only. SCS Mode and Test Print are unaffected.

Y may be used instead of K for this option.

EXAMPLE:     %Y07,1%  
                  Changes to dual case.

**LUI LANGUAGE**                    % K 08, value %

<b>Options</b>	<b>Values</b>
Request Language Download from CU	00
English (U.S.) EBCDIC	01 *Default
Austrian/German	03
Belgian	04
Brazilian	05
Canadian (French)	06
Danish/Norwegian	07
Danish/Norwegian (alternate)	08
Finnish/Swedish	09
Finnish/Swedish (alternate)	10
French	11
French (alternate)	12 (same as 11)
Austrian/German (alternate)	13
International Set 5	14
Italian	15
Japanese (English)	16
Japanese (Katakana)	17 (same as 16)
Spanish	19
Spanish (alternate)	20
Spanish Speaking	21
English (U.K.)	22
Norwegian	23 (same as 07)
Swedish	24 (same as 09)
EBCDIC (World Trade)	25 (same as 01)

<b>Options</b>	<b>Values (continued)</b>	
Norwegian (alternate)	26	(same as 08)
Swedish (alternate)	27	(same as 10)
Portuguese	28	
Canadian (Bilingual)	29	(same as 06)
French AZERTY (105-character)	30	(same as 11)
Swiss German	31	
Swiss French	32	(same as 31)

Defines the language for SCS (SNA LU Type 1) printing. This option is not used in DSC Mode printing. See **Appendix D** for a discussion of character-translation options.

Choose **00** for automatic setup to the control unit's configured language.

EXAMPLE:     %K08,24%  
Selects Swedish.

### **NOTE**

**Y may be used instead of K for this option.**

EXAMPLE:     %Y08,28%  
Selects Portuguese.

### **NOTE**

**00 is not available with 3274 or the 3276 config A or B.**

Changing this option to 00 must be reported to the IBM control unit. Follow the procedure under Option Change Exceptions in **Section 5.3**.

The foreign language option will be supported to the extent that the characters are available in the printer's symbol set. EBCDIC and buffer-code characters will be translated as closely as possible according to the tables in **Appendix D**. The standard Portuguese set will not be supported, as it requires programmed symbols. Canadian French extensions will be supported as closely as possible.

**PRINT QUALITY**                      % K 09, value %

<b>Options</b>	<b>Values</b>
Draft quality	1 *Default
Near letter quality	2

Selects between draft and near letter quality for dot-matrix printers such as the IBM Proprinter. See **Appendix G** for specific printer implementation.

EXAMPLE:     %K09,2%  
Changes to near letter quality.

### **NOTE**

**Y may be used instead of K for this option.**

EXAMPLE:     %Y09,1%  
Changes to draft quality.

**PRINTER PORT**                      % K 14, value %

<b>Options</b>	<b>Values</b>
Serial	1
Parallel	2 *Default

This parameter is used to select the active printer interface port. Depending on the setting chosen for this parameter, a different set of interface specification parameters will be displayed.

If Serial interface is selected, the Baud Rate, Bits Per Character, Parity, Printer Ready, and Printer Busy options apply. The DTE/DCE switch is used to select the appropriate pin configuration of the serial interface port.

Parallel must be selected as the active port if passthrough is enabled.

EXAMPLE:     %K14,1%  
Defines the serial port as active.



**NOTE**

**Y may be used instead of K for this option.**

EXAMPLE:     %Y14,2%  
                  Defines the parallel port as active.

BAUD            % K 15, value %

<b>Options</b>	<b>Values</b>
38400 baud	1
19200 baud	2
9600 baud	3 *Default
4800 baud	4
2400 baud	5
1200 baud	6
600 baud	7
300 baud	8
110 baud	9
75 baud	10

Defines the speed at which the serial port will run. The device attached to the port must be set to the same baud rate. If it is not, data being printed will be unrecognizable. This parameter is in effect whether or not passthrough is enabled.

EXAMPLE:     %K15,6%  
                  Defines a baud rate of 1200.

**NOTE**

**Y may be used instead of K for this option, but the values for each option differ. See the following table.**

EXAMPLE:     %Y15,3%  
                  Defines a baud rate of 2400.

Options	Values
300 baud	0
600 baud	1
1200 baud	2
2400 baud	3
4800 baud	4
9600 baud	5
19200 baud	6
38400 baud	7

**DATA BITS**                    % K 16, value %

Options	Values
7 bits	7
8 bits	8 *Default

This parameter is the number of data bits per character. Note that this specification is separate from and independent of parity selection. When outputting standard 7-bit ASCII characters with this parameter set to 8 bits, the eight bit is held as a zero. Data Bits allows full 8-bit output even when selecting parity protection. This parameter is in effect whether or not passthrough is enabled.

For total bit length excluding start and stop bits, refer to **Table A-2**.

**Table A-2. Total Bit Length.**

Character Length	Parity	Total Bit Length
7	Odd/Even	8
8	None	8
8	Odd/Even	9

EXAMPLE:    %K16,7%  
               Defines 7 bits per character.

**NOTE****Y may be used instead of K for this option.**

EXAMPLE:     %Y16,8%  
 Defines 8 bits per character.

**PARITY**        % **K 17**, value %

<b>Options</b>	<b>Values</b>
Odd	0
None	1 *Default
Even	2

Defines whether or not the parity bit is sent in addition to the data bits specified in Option 16, DATA BITS. The target printer must be set to match. This parameter is in effect whether or not passthrough is enabled.

If either Even or Odd parity is selected, the parity bit is sent in addition to the number of bits per character specified.

EXAMPLE:     %K17,2%  
 Defines even parity.

**NOTE****Y may be used instead of K for this option.**

EXAMPLE:     %Y17,0%  
 Defines odd parity.

**STOP BITS**        % **K 18**, value %

<b>Options</b>	<b>Values</b>
1 stop bit	1 *Default
2 stop bits	2

Defines the number of stop bits to send on the serial interface. This option is in effect whether or not passthrough is enabled.

EXAMPLE:     %K18,2%  
Sends 2 stop bits.

## NOTE

**Y may be used instead of K for this option.**

EXAMPLE:     %Y18,1%  
Sends 1 stop bit.

**DEVICE FLOW CONTROL     % K 19, value %**

<b>Options</b>	<b>Values</b>
None	0
XON/XOFF	1 *Default
DTR	2
RTS	3
Pin 11 low	7
Pin 11 high	8

This item defines which interface pin will be used by the A/C-6 (RO) to determine if flow control (busy signal) has been asserted by the device attached to the serial port. If the device does not support this type of signaling, select the XON/XOFF option. This parameter is in effect whether or not passthrough is enabled.

EXAMPLE:     %K19,7%  
Selects pin 11 low.

## NOTE

**Y may be used instead of K for this option.**

EXAMPLE:     %Y19,2%  
Selects DTR, pin 20.

**CONVERTER FLOW CONTROL****% K 20, value %**

<b>Options</b>	<b>Values</b>
None	0
XON/XOFF	1
CTS, pin 5	4 *Default
DSR, pin 6	5

Defines which interface pin will be used by A/C-6 (RO) to assert flow control to the device attached to the serial port. If the device does not support this type of signaling, select the XON/XOFF option. This parameter is only in effect when passthrough is enabled.

EXAMPLE:      %K20,5%  
                  Selects DSR, pin 6.

**DEVICE READY****% K 21, value %**

<b>Options</b>	<b>Values</b>
None	0 *Default
DTR, pin 20	2
RTS, pin 4	3
Pin 11 low	7
Pin 11 high	8

Defines which interface pin will be used by A/C-6 (RO) to determine if the device attached to the serial port is online and ready to receive data. If the device does not support this type of signaling, select the None option. This parameter is in effect whether or not passthrough is enabled.

EXAMPLE:      %K21,3%  
                  Selects RTS, pin 4.

**PASSTHROUGH**

% K 22, value %

**Options****Values**

Disabled

0 \*Default

Enabled

1

Defines whether or not data may be received on the serial port and passed to the parallel port. Passthrough disabled is the default, since configuration data may only be received on the serial port if passthrough is disabled. In addition to enabling passthrough, the parallel port must be made the active interface (see **Option 14, PRINTER PORT**).

EXAMPLE:     %K22,1%  
                  Enables passthrough.

**SERIAL TIMEOUT**

% K 23, value %

**Options****Values**

Timeout in 5-second intervals 1-255

Timeout after 15 seconds 3 \*Default

Defines the amount of time that the adapter will wait before servicing the serial passthrough port after processing a coax print job. This timeout starts decrementing after the “last” character is sent to the printer.

If additional coax print data is received before the timeout expires, the adapter will continue to print coax print data. If transmission of coax print data pauses long enough for the timeout to expire, interleaving of the coax and async print jobs is possible. If this happens, increase this timeout setting. In most cases, the default timeout is sufficient.

EXAMPLE:     %K23,12%  
                  Sets timeout period to 1 minute.

**HOST TIMEOUT****% K 24, value %****Options****Values**

Timeout in 5 second intervals	1-255
Timeout in 15 seconds	3 *Default

Defines the amount of time that the adapter will wait before servicing the async passthrough port after processing a coax print job. This timeout starts decrementing after the "last" character is sent to the printer.

If additional coax print data is received before the timeout expires, the adapter will continue to print coax print data. If transmission of coax print data pauses long enough for the timeout to expire, interleaving of the coax and async print jobs is possible. If this happens, increase this timeout setting. In most cases, the default timeout is sufficient.

EXAMPLE:     %K24,12%  
Sets timeout period to 1 minute.

**FORM FEED BEFORE LOCAL COPY****% K 25, value %****Options****Values**

No; do not send FF before local copy	0 *Default
Yes; send FF before local copy	1

Specifies whether or not a form-feed command will be sent to the printer before a local copy print. Choosing 1 for both Option 25 and Option 26 assures that local copy prints appear on separate forms and that they are ejected from the printer.

EXAMPLE:     %K25,1%  
Sends a form feed before local copy print.

**NOTE**

**This option affects host-initiated local copy print as well as operator-initiated local copy print.**

**Y may be used instead of K for this option.**

EXAMPLE:        %Y25,0%  
Does not send a form feed before local copy print.

**FORM FEED AFTER LOCAL COPY**        % K 26, value %

Options	Values
No; do not send FF after local copy	0 *Default
Yes; send FF after local copy	1

Specifies whether or not a form-feed command is to be sent to the printer after a local copy print. Choosing 1 for both Option 25 and Option 26 assures that local copy prints appear on separate forms and that they are ejected from the printer.

EXAMPLE:        %K26,1%  
Sends a form feed after local copy print.

## NOTE

**These options affect host-initiated local copy print as well as operator-initiated local copy print.**

**Y may be used instead of K for this option.**

EXAMPLE:        %Y26,0%  
Does not send a form feed after local copy print.

**SUPPRESS NULL LINES**        % K 27, value %

Options	Values
Yes; suppress null lines; emulate 3287	0 *Default
No; print true image	1

Null-line suppression refers to the handling of formatted mode print lines that contain only attributes, nulls and/or non-display fields (that is, no printable characters). Suppress Null Lines specifies if null lines are to be suppressed and discarded or if they are to be printed as blank lines.



To be compatible with most IBM printers, null lines are suppressed. In other words, the line will be discarded and a blank line will not appear in the printout. A/C-6 (RO) offers the option of either emulating IBM or printing a true image of the formatted data. By not suppressing the null lines, the printout will appear the same as the original format. Because a local copy print will result in a distorted image if null lines are suppressed, this option is also known as true image copy.

To print an image identical to that displayed when using local copy, select 1 for this option.

EXAMPLE:        %K27,1%  
Changes from emulating the 3287 to printing the true image.

### **NOTE**

**This option only affects “formatted” mode DSC output. In both DSC unformatted mode and in SCS mode, null lines always appear in the printout as blank lines. Spaces (40H) are also considered printable characters.**

**Y may be used instead of K for this option.**

EXAMPLE:        %Y27,0%  
Changes to emulate the 3287 and suppress null lines.

**CR AT MPP + 1 % K 28, value %**

<b>Options</b>	<b>Values</b>
Auto NL; send New Line	0 *Default
No Auto NL; suppress New Line	1

Specifies whether or not to generate an automatic New Line if a Carriage Return is found at the Maximum Print Position plus 1.

EXAMPLE;        %K28,1%  
Suppress New Line.

**NOTE**

This option only affects DSC Mode output.

Y may be used instead of K for this option.

EXAMPLE: %Y28,0%  
Send New Line.

NL AT MPP + 1 % K 29, value %

Options	Values
Auto NL; send New Line	0 *Default
No Auto NL; suppress New Line	1

Specifies whether or not to generate an automatic New Line if a New Line is encountered at the Maximum Print Position plus 1.

EXAMPLE: %K29,1%  
Suppress New Line.

**NOTE**

This option only affects DSC Mode output.

Y may be used instead of K for this option.

EXAMPLE: %Y29,0%  
Send New Line.

SPACE AFTER FORM FEED? % K 30, value %

Options	Values
Yes; generate space	0 *Default
No; suppress space	1

This parameter allows you to specify whether or not a blank space will appear in your printout in the first print position of the next form following a DSC Form Feed.

Normally, on an IBM printer operating in DSC mode, the top line of each new form is missing the left-most character position. This position has the form-feed command in the host data stream.

For 3287 compatibility, the default is 0 (generate space). To regain the print position taken up by the blank space, set this option to 1 (suppress space).

EXAMPLE:        %K30,1%  
                  Suppress space following form feed.

### **NOTE**

**This option only affects DSC Mode output. In SCS Mode, by IBM definition, a form-feed command takes up no space in the printout.**

**Y may be used instead of K for this option.**

EXAMPLE:        %Y30,0%  
                  Generate space following form feed.

**FF AT END OF BUFFER            % K 31, value %**

#### **Options**

#### **Values**

Do NL; send new line after form feed	0 *Default
suppress NL; suppress new line after form feed	1

Defines the action when a form feed is the last character in an unformatted DSC print buffer.

EXAMPLE:        %K31,1%  
                  Suppresses a new line from being sent to the printer after a Form Feed that is the last character in an unformatted DSC print buffer.

### **NOTE**

**Y may be used instead of K for this option.**

**EXAMPLE:**     %Y31,0%  
 Causes a new line to be sent to the printer after a form feed that is the last character in an unformatted DSC print buffer.

**FORM FEED VALID**                    % K 32, value %

Options	Values
Emulate 3287; execute form feed in first position only	0 *Default
Anywhere; execute form feed from anywhere	1

This parameter specifies when a form feed will be considered valid in a print line.

Normally, on all IBM printers operating in DSC mode, a form-feed command is restricted to the first position of a print line. If a form-feed command is received anywhere else, it is considered invalid and ignored. This parameter allows you to specify that a form-feed command will be accepted any place in data.

**EXAMPLE:**     %K32,1%  
 Execute form feed.

## NOTE

**This option only affects DSC Mode output. In SCS Mode, by IBM definition, a form-feed command may appear anywhere in the data stream.**

**If Option 39, PRINT EMPTY FORM, is set to No, and Option 32 is set to Yes, form feeds will still be ignored (suppressed) if they occur at the top-of-form position.**

**Y may be used instead of K for this option.**

**EXAMPLE:**     %Y32,0%  
 Do not execute form feed.

**FORM FEED EMULATION****% K 35, value %****Options****Values**

Use FF; send form feed	0 *Default
Use LFs; send line feeds in place of form feed	1

This parameter lets you specify whether you want the A/C-6 (RO) to emulate a form-feed command by sending line feeds to the printer, or to pass the form-feed command as is.

If 1 (Send Line Feeds) is specified, all form feeds will be emulated by sending the needed number of line feeds. If 0 (Send Form Feed) is specified, an ASCII form feed character will be sent when a form feed is desired.

If your printer or device does not support form feed, specify 1 and all form feeds will be emulated by A/C-6 (RO) by sending the appropriate number of line feeds to the device.

If your printer supports form feed but the form length is changing or is nonstandard, letting A/C-6 (RO) emulate form-feed commands with line feeds may be the better choice. Because A/C-6 (RO) does not have a means of downloading forms length to your printer, a changing forms length or a nonstandard one would require you to specify the length to both A/C-6 (RO) and your printer. In this case, specify 1 (Send Line Feeds) also.

If your printer supports form feed and forms length does not change, choose 0 (Send Form Feed).

The lines per page number used in counting line feeds is either specified in Option 05, FORM LENGTH, or specified in the latest SCS Set Vertical Format command. The SVF command will not work unless Option 35 is set to 1.

If the form length to be used is smaller than the physical page and is an even multiple of it, then 1 (Send Line Feeds in Place of Form Feed) should be chosen. An example of this would be a label-printing application.

**EXAMPLE:**        %K35,1%  
                     Changes to send line feeds in place of each Form Feed.

**NOTE**

**Y may be used instead of K for this option.**

EXAMPLE: %Y35,0%  
Changes to send a Form Feed in place of Line Feeds.

**VERTICAL CHANNEL SELECT SUPPORT** % K 37, value %

**Options****Values**

No; VCS commands not supported	0 *Default
Yes; VCS commands supported	1

Defines what will be sent to the printer when a Vertical Channel Select (VCS) command is received. If this option is set to 0 (VCS commands not supported), one line feed will be sent to the printer. If this option is set to 1 (VCS commands supported), the printer will be sent the number of line feeds required to advance to the vertical channel specified. The vertical channels are set by the SVF command.

EXAMPLE: %K37,1%  
Yes, VCS commands are supported.

**NOTE**

**Y may be used instead of K for this option.**

EXAMPLE: %Y37,0%  
No, VCS commands are not supported.

**PRINT EMPTY FORM** % K 39, value %

**Options****Values**

Yes; send empty form	0 *Default
No; suppress empty form	1

This parameter specifies whether or not to print blank printout pages. If the parameter is set to 1 (suppress empty form), all form-feed commands that would result in blank pages are ignored. Form-feed commands are ignored if received when positioned at the top of a form.

Top of form is defined as the first print position on the top line of a form. If positioned on the top of form line, and if no printable characters have been sent to the printer on that top of form line, a form-feed command would be ignored.

Various IBM printers do not all react the same when issued a form-feed command while positioned at the top of a form. The IBM 3287 and 3289 suppress the FF in most cases, while the 3230, 3262, 3268, and 3288 perform the FF and skip a blank form.

EXAMPLE:       %K39,1%  
                  No, suppress empty forms.

### NOTE

**This option affects both DSC and SCS Mode output. When set to 1 (Suppress Empty Forms), all FFs that would result in blank printout pages are ignored. This differs from the IBM3287, which suppresses FFs only in DSC Mode.**

**Y may be used instead of K for this option.**

EXAMPLE:       %Y39,0%  
                  No, do not suppress empty forms.

**INTERVENTION REQUIRED DELAY   % K 46, value %**

<b>Options</b>	<b>Values</b>
IR timeout in 5 second intervals	0-255
Send IR after 1 minute	12 *Default

Defines the printer-not-ready error timeout period during host printing. Any time host printing is occurring, if the printer goes not ready, the time period specified here will be counted down. If time expires before the printer is restored, an Intervention Required (IR) error is sent to the host. Printer not ready can be caused by paper empty, operator panel switch off-line, or printer malfunction.

**NOTE**

Time is specified in 5-second intervals.

1 minute.....	=12
1 minute 30 secs.....	=18
2 minutes.....	=24
2 minutes 30 secs.....	=30
3 minutes.....	=36
3 minutes 30 secs.....	=42
4 minutes.....	=48
4 minutes 30 secs.....	=54
5 minutes.....	=60
5 minutes 30 secs.....	=66
6 minutes.....	=72
7 minutes.....	=84
8 minutes.....	=96
9 minutes.....	=108
10 minutes.....	=120
20 minutes.....	=240

EXAMPLES: %K46,0%  
Never send IR to the host; wait forever for printer to recover.

%K46,48%

Send IR to the host if printer not ready for more than 4 minutes.

**NOTE**

**Y may be used instead of K for this option.**

EXAMPLES: %Y46,60%  
Send IR to the host if printer not ready for more than 5 minutes.



**FORMATTED HEX TRANSFER % K 47, value %**

<b>Options</b>	<b>Values</b>
Single Byte	1 *Default
Counted	2

Specifies whether the data following the Formatted Hex Transfer Prefix is in Single Byte or Counted mode.

EXAMPLE:     %K47,2%  
Selects Counted Mode in Formatted Hex Transfer.

**NOTE**

**Y may be used instead of K for this option.**

EXAMPLE:     %Y47,1%  
Selects Single Byte Mode in Formatted Hex Transfer.

**POWER-UP STRINGS                   % K 51, string #(s) %**

<b>Options</b>	<b>Values</b>
Send String 0 at power-on	0
Send String 1 at power-on	1 *Default
—through—	
Send String 7 at power-on	7

Specifies which user-defined initialization string(s) will be sent at power-on. You can send up to 8 strings (0-7). The contents of the strings are defined by Option 61, USER INITIALIZATION STRING.

EXAMPLE:     %K51,2,6%  
Sends strings 2 and 6 to the printer.

To specify that no initialization string be sent, Option 51 must be cleared in the following way:

EXAMPLE:     %K51%

## NOTE

If no User Initialization String 1 has been defined by Option 61, the printer-driver default string will be sent when this option is set to 1. If this option is cleared (%K51%), no initialization string will be sent. However, the 6 or 8 LPI setup string will always be sent at initialization. The printer-driver default initialization string can be found in Appendix G.

When more than one string is referenced, the strings will be sent in ascending numerical order, even though the strings defined need not be listed in numerical order (for example, %K51,6,2% is equivalent to %K51,2,6%).

**USER INITIALIZATION STRING**      % K 61, string #, value, %

### Options

### Values

Specify User String 0  
—through—

0 (string #, hex content)

Specify User String 7

7 (string #, hex content)

Specifies the number and contents of a printer initialization string. String numbers may range from 0 to 7. Each string may be a maximum length of 254 characters.

EXAMPLE:      %K61,1,1b,35%  
                 Defines user string 1 as 1B 35.

These strings are sent by specifying Option 51 and may also be sent (independent of the Option 51 setting) by using the Zn command, SEND PRINTER INITIALIZATION STRING (where n=0-7).

Strings are cleared by specifying a null string.

EXAMPLE:      %K61,1%  
                 Clears user string 1.

## NOTE

Unless strings are defined temporarily using this option and will be lost (unless they are saved) when the unit is powered off. To save the strings permanently, use the X1 command, MAKE CHANGES PERMANENT, or Option 101, SAVE PRESET.

**CREATE TABLE****% K 71, n %**

<b>Options</b>	<b>Values</b>
Create Translate Table 1	1 *Default
Create Translate Table 2	2
—through—	
Create Translate Table 8	8

Allocates space (if no table presently exists) and deploys the 7-bit ASCII table for the designated number. This table will exist in RAM and will be copied to EEPROM with the issuance of the %X1 command, or Option 101, SAVE PRESET.

EXAMPLE:        %K71,2%  
                  Creates Translate Table 2.

**NOTE**

**Creating a table does not automatically select it, but it must be created if it does not already exist.**

**DELETE TABLE****% K 72, n %**

<b>Options</b>	<b>Values</b>
Delete Translate Table 2	2
Delete Translate Table 3	3
—through—	
Delete Translate Table 8	8

Deletes Translate Table n from the existing tables and releases the EEPROM space that table n was occupying.

EXAMPLE:        %K72,8%  
                  Deletes Translate Table 8.

**NOTE**

Translate Table 1 cannot be deleted.

**SELECT TABLE**                      % K 73, n %

<b>Options</b>	<b>Values</b>
Select Translate Table 1	1 *Default
Select Translate Table 2	2
—through—	
Select Translate Table 8	8

Selects Translate Table n to be the active translate table. If Translate Table n does not exist, then an error message is printed.

**EXAMPLE:**        %K73,3%  
Selects Translate Table 3 as active.

**MODIFY TABLE**                      % K 75, addr, code %

<b>Options</b>	<b>Address</b>	<b>Code</b>
Overwrite a character	Address code of character	New code to output

Allows any printable character in the active user translate table to be overwritten.

**NOTE**

**To overwrite a character, refer to the appropriate Printer Character Translation Tables (Printable Character, Hex Character) in Appendix D, Character-Translation Tables.**

**EXAMPLE:** First, locate the \$ character in the Printable Character table and determine its address by its column and row. The \$ is found at the intersection of column 2, row 4.

Next, find the ? character at column 3, row F. Now refer to the Hex Character table at location 3F for the replacement code. In this case, that code also happens to be 3F.

```
%K75,24,3F%
```

Changes the \$ character (ASCII 24) to output the ? character (ASCII 3F).

### **ESCAPE CHARACTER DEFINITION**

This is a specific example of the OVERWRITE TRANSLATE TABLE option. Any character found in the Printer Character Translate Table may be redefined as the escape character for printer commands, but it would be best to choose a character seldom or never used. As long as a character is defined as the escape character, it cannot be printed. The code for the escape character is always 1B.

This option allows escape sequences to be embedded directly in print files, providing control of the printer with a minimum of setup time. All escape sequences not requiring binary data may be sent in this manner. For sending longer escape sequences, see **Appendix E, Transparent Data Transfer**.

### **NOTE**

**To redefine a character for use as the escape character, locate the character you want to use in the Printer Character Translate table (Printable Character) in Appendix D and determine the character's address by its column and row.**

**EXAMPLE:** To redefine the # character as the escape character, locate the # in column 2, row 3 of the Printer Character Translate Table. The address of the # is 23.

```
%K75,23,1B%
```

Changes the # character (ASCII code 23) to output the Escape character ASCII 1B.

Remember not to use any of the characters or numbers that appear in A/C-6 (RO) command sequences (that is, & ? , \* K Y V X Z).

EM ACTION

% K 89, value %

Options	Values
Nothing	0
Send a New Line	1 *Default
Send a Form Feed	2

This parameter specifies the action to be taken at the end of each unformatted DSC mode print. If the printer is already at the beginning of the new line or new form, the automatic NL or FF is suppressed.

Normally, at the end of each unformatted DSC mode print, if not positioned at the first position of the next line, a new line is sent. This is true for all IBM printers and is the default for this parameter.

In some applications, a break between each printout is desired. By setting this parameter to perform a form feed, an automatic skip to the beginning of the next form can be achieved, just as with the default.

For option 1 (Send a New Line), the printout must be unformatted and the current field must be displayable. Additionally, if already at the beginning of the new form, automatic FF is suppressed.

By using option 0 (Nothing) at End of Message, printouts spanning buffers can be allowed to continue on the same line with the next print position. In other words, print line formatting can be achieved independently from the IBM message buffer formatting.

By setting this option to 0, printouts spanning buffers can be allowed to continue on the same line with the next print position.

## NOTE

**This option affects only unformatted DSC mode output. The End of Message feature is not supported in formatted DSC Mode or SCS Mode. No special action is available for either of those modes.**

**SCS TRANSLATE****% K 90, value %**

<b>Options</b>	<b>Values</b>
Transparent	0
Emulate 3287	1 *Default

Specifies how transparent data sent using SCS code 35 is to be handled.

If the option is set to 1 (Emulate 3287), valid graphic characters are printed normally (that is, converted from EBCDIC to ASCII), control codes and invalid graphics are printed as hyphens, and normal page formatting is maintained.

If the option is set to 0 (Transparent), this special handling is disabled. The 8-bit binary codes are sent out by the A/C-6 (RO) just as they are received.

**PRINTER EMULATION****% K 91, value %**

<b>Options</b>	<b>Values</b>
TTY (Generic Printer Driver)	0 *Default
C.ITOH 300, 400, 600, 800	2
XEROX/DIABLO 630 Emulation	7
EPSON FX-80	8
HP LaserJet series II-Landscape	11
HP LaserJet series II-Portrait	12
IBM Proprinter	15
XEROX 4045 (2700 Emulation-Portrait)	24
XEROX 4045 (2700 Emulation-Landscape)	25
OTC 2100 Series	26

Selects and ASCII printer driver. The printer drivers listed above are currently supported.

**EXAMPLE:**     %K91,24%  
 Selects the printer driver for XEROX 4045  
 (2700 Emulation-Portrait).

## NOTE

When selecting a printer driver, verify that the setting of Option 21, DEVICE READY, is compatible with the attached device. The default value for this option is 0 (Generic Printer Driver).

Selecting the printer driver automatically changes the line length, characters per inch, Emulate Line Feed, and Emulate Backspace options. See Appendix G for the default page widths of each printer driver.

### APPLY TO TABLE

Options	Values
ASCII 7-bit	0 *Default
ISO	1
ROMAN-8	2
IBM PC	3

Overwrites the active user translation table to support common symbol sets. It is equivalent to sending a series of MODIFY TABLE (Option 75) commands necessary to support the common symbol set. Currently supported symbol sets are listed above.

EXAMPLE:     %K92,3%  
              Selects the IBM PC printer character-translation table.

## NOTE

Selecting the translation table will not automatically send the escape sequence necessary to change the printer symbol set. Symbol-set selection can be invoked by entering Hex Transfer Mode and sending the desired escape sequence or by making the escape sequence a part of the user-defined initialization string (see Option 61, USER INITIALIZATION STRING).

Translation tables can be further modified, if necessary, by using Option 75, MODIFY TABLE.



**DELIMITED PSEUDO PREFIX % K 94, value, value, %****Options****Values**

Specify ASCII character codes

\*No Default

Allows creation of a customized trigger character or string of characters to indicate that Delimited Hex Transfer Mode data follows. A string of up to eight characters may be defined. Choose a sequence that is simple, but one that does not occur in normal print data.

EXAMPLE:        %K94,25,21 %  
                   Defines the trigger for Delimited Hex Transfer as the  
                   character sequence % ! (ASCII 25,21).

**NOTE**

**Characters are entered in their equivalent ASCII Hex codes. Refer to the Printer Character Translate Tables in Appendix D.**

**The character or string defined must be different than the one defined for Formatted Hex Transfer, since the Delimited Hex Transfer Mode is always checked first and therefore Formatted Hex Transfer Mode would never be reached.**

**NOTE**

**Delimited Hex Transfer Mode can also be initiated by entering the currently defined trigger character twice.**

EXAMPLE:        % % 4 1 4 2 %  
                   Sends A B to the printer.

**DELIMITED PSEUDO SUFFIX % K 95, value %****Options****Values**

Specify ASCII character codes

\*No Default

Allows creation of a customized trigger character to indicate the termination of Delimited Hex Transfer data. Only one character may be defined.

**EXAMPLE:**     % K95,24 %  
 Defines the trigger for the end of Delimited Hex Transfer as the \$ character (ASCII 24).

                  % K95,5D %  
 Defines the trigger for the end of Delimited Hex Transfer as the ] right square bracket character (ASCII 5D).

## NOTE

**Characters are entered in their equivalent ASCII hex codes. Refer to the Printer Character-Translation Tables in Appendix D.**

## NOTE

**If Delimited Hex Transfer Mode has been entered by sending the currently defined trigger character twice, the currently defined trigger character must be used as the delimited suffix.**

**EXAMPLE:**     % % 4 1 4 2 %  
 Sends A B to the printer.

**FORMATTED PSEUDO PREFIX**            % K 96, value, value, %

### Options

Specify ASCII character codes

### Values

\*No Default

Allows creation of a customized trigger character or string of characters to indicate that Option 47, FORMATTED PSEUDO, single byte or counted data follows. A string of up to eight characters may be defined. Choose a sequence that is unique (that is, one that does not occur in normal print data).

**EXAMPLE:**     % K96,40 %  
 Defines the Formatted Pseudo trigger as the @ character (ASCII 40)

                  % K96,7B,7B,7B,7B,7B %

                  Defines the Formatted Pseudo trigger as a string of five left curled brace characters {{{{{ (ASCII 7B).

**NOTE**

Characters are entered in their equivalent ASCII hex codes. Refer to the Printer Character Translate Tables in Appendix D.

The character or string defined must be different than the one defined for Delimited Hex Transfer, since the Delimited Hex Transfer Mode is always checked first and therefore Formatted Hex Transfer Mode would never be reached.

**NOTE**

The currently defined trigger character can also be used to initiate Formatted Hex Transfer Mode.

EXAMPLE:     % % 4 1 4 2 %  
              Sends A B to the printer.

**REPORT ERRORS**                   % K 97, value %

<b>Options</b>	<b>Values</b>
No; do not report errors	0
Yes; report errors	1 *Default

Defines whether or not A/C-6 (RO) error messages are to be printed. If set to 0 (Do Not Report Errors), errors will not be printed and no indication of their occurrence will be given to the operator.

Error messages may include self test failure messages, special A/C-6 (RO) command stream error messages, and hex transfer data stream error messages. A list of error messages can be found in **Appendix K**.

Local error reporting can be especially useful during initial installation and option setup, and whenever new host print applications are tested.

EXAMPLE:     % K97,0 %  
              Turns off local error message printing.

**LINE FEED AND/OR BACKSPACE EMULATION**

% K 98, value %

<b>Options</b>	<b>Values</b>
Do not emulate either	0 *Default
Emulate LF, do not emulate BS	1
Emulate BS, do not emulate LF	2
Emulate both LF and BS	3

Specifies how the SCS Line Feed (LF) and SCS Backspace (BS) should be handled. If LF is to be emulated (Option 1 or 3), when an SCS LF is received the printer will be sent a Carriage Return CR/LF followed by the number of spaces required to return to the active print position before the LF. If LF is not to be emulated (Option 0 or 2), the printer will be sent a single LF.

If BS is to be emulated (Option 2 or 3), when an SCS BS is received, the printer will be sent a CR followed by the number of spaces required to obtain the print position resulting from the SCS BS. If BS is not to be emulated (Option 0 or 1), the printer will be sent a single BS.

EXAMPLE:     % K98,1 %  
                  Emulate LF, do not emulate BS.

**POWER-ON PRESET**

% K 99,n %

<b>Options</b>	<b>Values</b>
Designate power-on Preset 1 —through—	1 *Default
Designate power-on Preset 8	8

Designates the preset that is active at power-on. Preset n is saved in EEPROM immediately upon receiving this command. The work area is unaffected by this command.

EXAMPLE:     % K99,8%  
                  Designates Preset 8 as active at power-on.

**GET PRESET**                    **% K 100, n %**

<b>Options</b>	<b>Values</b>
Get Preset 0	0
— <i>through</i> —	
Get Preset 9	9

Copies Preset n into the work area for editing and recalls all global options from EEPROM. Global options are those options that pertain to Printer Translate Tables and Initialization Strings. All subsequent option commands up until Option 101, SAVE PRESET, that apply to preset options will affect only the work area and not the active configuration.

EXAMPLE:            **% K100,6 %**  
 Gets Preset 6 into the work area.

**SAVE PRESET**                    **% K 101, n %**

<b>Options</b>	<b>Values</b>
Save Preset 1	1
— <i>through</i> —	
Save Preset 9	

Saves the work area to the EEPROM Preset n and stores all global options to EEPROM. Global options are those options that pertain to Printer Translate Tables and Initialization Strings. All subsequent option commands affect the active configuration and not the work area.

EXAMPLE:            **% K101,2 %**  
 Saves the work area to Preset 2.

**ACTIVATE PRESET**                      % K 102, n %

<b>Options</b>	<b>Values</b>
Activate Preset 0 —through—	0
Activate Preset 8	8

Causes Preset n to be moved from EEPROM to active. All appropriate strings will be sent to the printer. It does not affect the work area.

EXAMPLE:     % K102,3 %  
                  Activates Preset 3.

**PRINT USER TABLE**                      % K 103, n %

<b>Options</b>	<b>Values</b>
Print Translate Table 1 —through—	1
Print Translate Table 8	8

Prints any of the user translate tables in the same format as they would appear on a test print.

EXAMPLE:     % K103,3 %  
                  Prints Translate Table 3.

**PRINT USER STRING**                      % K 104, n %

<b>Options</b>	<b>Values</b>
Print User String 0 —through—	0
Print User String 7	7

Prints any of the user initialization strings in hexadecimal format.

EXAMPLE:     % K104,7 %  
                  Prints String 7.

**NOTE**

Use this command to print the entire user string in hex. A test print only shows the first 20 bytes of a user string.

**MICRO ADJUST**                             % K 110, value %

<b>Options</b>	<b>Values</b>
Disabled	0 *Default
Enabled	1

When this option is enabled, an overstrike effect will be emulated to support applications written that rely on this effect to make text boldface.

EXAMPLE:     % K110,0 %  
                  Do not emulate overstrike effect.

**NOTE**

This option must be disabled when using Counted or Single-Byte Hex Transfer Mode.

**NEW LINE SEQUENCE**                       % K 111, value %

<b>Options</b>	<b>Values</b>
CR/LF	0 *Default
LF/CR	1

Specifies in what order the new line sequence will be sent to the printer. Options are Carriage Return, Line Feed and Line Feed, Carriage Return.

EXAMPLE:     % K111,1 %  
                  Send LF/CR at new line.

**COUNT PSEUDO COLUMNS**

% K 112, value %

**Options****Values**

No, disabled

0 \*Default

Yes, enabled

1

When this option is enabled, A/C-6 (RO) is instructed to count pseudo-characters as columns, since pseudo-characters will affect line length. This ability is necessary in some applications.

Left on the default setting, A/C-6 (RO) does not let pseudo-characters affect line length.

EXAMPLE:       % K112,1 %  
                  Enable this option. Count pseudo-characters as columns.

**TRANSLATE NULLS**

% K 113, value %

**Options****Values**

As spaces

0 \*Default

As nulls

1

This option specifies if nulls are to be translated as spaces or as nulls. The default translates nulls as spaces.

EXAMPLE:       % K113,1 %  
                  Translates nulls as nulls.

**EJECT LAST PAGE**

\$ K 114, value %

**Options****Values**

Timeout in 5-second intervals

1-255

Never time out

0 \*Default



Some printers will hold the last page in RAM if no end of page is sent. This option instructs the printer to eject the last page after a specified timeout. Each value specifies time in 5-second intervals.

EXAMPLE:       % K114,12 %  
                  Eject the last page if no data has been received for one  
                  minute.

## **A.1 Other Commands**

**Print Preset       %Vn**

The Vn command, PRINT PRESET, activates a test print of Preset n without having to actually press the test button. Use caution because the test print can occur at any time, including in the middle of a print. To print the active configuration, send %V9.

EXAMPLE:       % V9  
                  Prints the active configuration.

**Send Printer Initialization String %Zn**

The Zn command, SEND PRINTER INITIALIZATION STRING, allows you to reinitialize the printer at any time by sending the string defined by Option 61, USER INITIALIZATION STRING. Values 0-7 are allowed for the parameter n.

EXAMPLE:       % Z3  
                  Sends User String 3.

# Appendix B: SCS Mode Printing

All of the configuration options referred to in this chapter can be altered at a host display station, at a serial connected PC, or from the A/C-6 (RO)'s front panel controls.

## B.1 SCS Page Format

During SCS transmissions, printout format is under complete control of the application. Page-format parameters are reinitialized whenever a bind is accepted from a new SCS session. If there was no previous SCS session, your current option settings provide the defaults for the SCS session. If there had been a previous SCS session, the page-format parameters that were in effect in the previous session are restored for the new session. Changes made using SCS control codes override your settings for the duration of an SCS session.

Maximum print area is determined by IBM page-format parameters in conjunction with your printer's page-orientation and font characteristics. Page-format defaults are determined by the option settings for FORM LENGTH, LINE LENGTH, LINES PER INCH (vertical line density), and CHARACTERS PER INCH (horizontal print density).

### Top Margin (TM)

The first print line of a form. It is the top-of-form line. TM defaults to line 1 and can be changed using the Set Vertical Format (SVF) function.

### Maximum Print Position (MPP)

The rightmost print position of a form. The setting of Option 06, LINE LENGTH, provides the default MPP. MPP can be changed using the Set Horizontal Format (SHF) function.

### Maximum Page Length (MPL)

The maximum number of vertical lines that can be printed on each form. The setting of Option 05, FORM LENGTH, provides the default MPL. MPL can be changed using the Set Vertical Format (SVF) function.

**Left Margin (LM)**

The leftmost print position of a form. LM defaults to column 1 and can be changed using the Set Horizontal Format (SHF) function.

**Right Margin (RM)**

The rightmost print position, determined by MPP.

**Bottom Margin (BM)**

The last print line of a form. BM defaults to the MPL setting (Option 05, FORM LENGTH) and can be changed using the Set Vertical Format (SVF) function.

**B.2 SCS Control Codes**

Some of the control codes used in SCS Mode include variable numbers that can be sent in error. Any variables found in error cause an Invalid Parameter Error response to the control unit for the data block containing the incorrect SCS control code sequence. Printing of the data block terminates immediately at the point of the error.

The following control codes are supported in SCS Mode:

**BACKSPACE (BS)                      EBCDIC=16H**

The BS code moves the print position one character to the left on the current line. The data sent to the printer is determined by the setting of EMULATE BACKSPACE in the Printer Parameters menu.

**BELL (BEL)                              EBCDIC=2FH**

The BEL code is accepted and a bell character is output to the printer if a printer driver is being used that supports this function (see Option 91, PRINTER EMULATION). BEL does not cause printing to stop.

**CARRIAGE RETURN (CR)              EBCDIC=0DH**

The CR code moves the print position to the left margin of the current line. It causes a Carriage Return and the appropriate number of spaces to be sent to the printer to move the print position to the left margin.

**ENABLE PRESENTATION (ENP)****EBCDIC=14H**

The ENP code is accepted but does not generate any print output.

**FORM FEED (FF)****EBCDIC=0CH**

The FF code moves the print position to the top left margin of the next form. It causes the output of either a Form Feed or the appropriate number of Line Feeds to position the printer at the top of the next form, depending on the setting of Option 35, FORM FEED EMULATION. These are followed by a Carriage Return and the number of spaces necessary to move the print position to the left margin.

**GRAPHIC ESCAPE (GE)****EBCDIC=08H**

Graphic Escape is an unsupported function. The GE code and the character following are accepted and cause a single space character to be sent to the printer.

Normally, the GE code is used to send APL/Text/Graphic characters in an SCS data stream.

**HORIZONTAL TAB (HT)****EBCDIC=05H**

The HT code causes spaces to be sent to the printer to move the print position horizontally to the next tab stop. Horizontal tab-stop positions are set by using the Set Horizontal Format (SHF) function.

If there are no horizontal tab stops set to the right of the current print position, an HT code results in a single space.

**INHIBIT PRESENTATION (INP)****EBCDIC=24H**

The INP code is accepted but does not generate any print output.

**INTER-RECORD SEPARATOR (IRS)****EBCDIC=1EH**

Inter-Record Separator is an unsupported function. The IRS code is accepted and a New Line (NL) function is performed.

The IRS code is a separator character normally used in an SSCP-LU session. If received in an LU-LU session, a NL is performed. The IRS code will result in a CR and LF being sent to the printer.

**LINE FEED (LF)****EBCDIC=25H**

The LF code moves the print position vertically to the next line. The horizontal position does not change. The data sent to the printer is determined by the setting of EMULATE LINE FEED in the Printer Parameters menu.

**PAGE PRESENTATION MEDIA (PPM) EBCDIC=2BD2H**

The PPM code is accepted but ignored.

**NEW LINE (NL)****EBCDIC=15H**

The NL code moves the print position to the left margin of the next line. It causes a CR, LF (Carriage Return, Line Feed) sequence plus the appropriate number of spaces to be sent to the printer to move the print position to the next line's left margin.

If an NL code is located before, at, or one character past the current maximum line length, a single vertical space will occur. Attempts to print past the current maximum line length without an NL will cause the automatic generation of an NL in addition to those embedded in the data stream.

The current MPP is defined by the SHF (Set Horizontal Format) function, or in lieu of that, by the setting of Option 06, LINE LENGTH.

**SET ATTRIBUTE (SA)****EBCDIC=28H**

The Set Attribute function determines how all following data is to be printed. It may be used to define character attributes such as bold and underline for a single character or a string of characters.

The SA code is followed by two additional bytes. The first byte represents the attribute type. Valid types are 00=Reset, 41=Extended Highlighting, 42=Color, and 43=Character Set. The type byte is followed by a byte that specifically defines the print characteristics.

RESET sets the current attribute to normal highlighting, black color, and default character set.

28 00 00.....Reset

EXTENDED HIGHLIGHTING allows choice of boldface print and underline as follows:

28 41 00 .....Normal (default).....Stop underline/bold  
 28 41 F1 .....Blink.....Ignored  
 28 41 F2 .....Reverse video.....Bold print  
 28 41 F4 .....Underscore.....Underline

COLOR choice is an unsupported function and is ignored.

28 42 00 .....Normal=Black (default)  
 28 42 F1 .....Blue.....Ignored  
 28 42 F2 .....Red.....Ignored  
 28 42 F3 .....Pink (Magenta).....Ignored  
 28 42 F4 .....Green.....Ignored  
 28 42 F5 .....Turquoise (Cyan).....Ignored  
 28 42 F6 .....Yellow.....Ignored  
 28 42 F7 .....Multicolor.....Ignored

CHARACTER SET choice is an unsupported function and is ignored.

28 43 00 .....Normal (default)  
 28 43 F1 .....APL/Text Print.....Ignored  
 28 43 40 .....Program Symbol Sets.....Ignored  
 -EF.....Program Symbol Sets.....Ignored

## SET HORIZONTAL FORMAT (SHF)

EBCDIC=2BC1H

The SHF code defines the horizontal line format: the left and right margins, horizontal tab stops, and maximum line width.

The SHF code is followed by a number of additional bytes. The first byte represents a one byte binary count that indicates the total number of bytes following, including the count byte.

The next three bytes following the count byte define the maximum print position (MPP or line width), the left margin (LM), and the right margin (RM). Horizontal tab stop settings follow the right margin position. All values are expressed as one-byte binary numbers.

The minimum SHF sequence is three bytes long (SHF code plus a count of 01), which sets the horizontal print-line format to your option settings. The SHF sequence is:

(SHF)(count)(MPP)(LM)(RM)(T1)(T2)...(Tn)

**MPP**—Defines a line width less than or equal to the maximum print position (255). If the MPP is set to a value greater than the physical page width, data will be lost.

**LM**—Specifies the column value of the left most print position. The LM also serves as the first horizontal tab stop. Valid LM values are less than or equal to the MPP. The LM default value is 1.

**RM**—Not used in printing operations.

**T1...Tn**—Horizontal tab stop settings. The tab stops do not need to be in order. Valid tab stop values are less than or equal to the MPP.

## **NOTE**

**When an SHF command is received, the printer is positioned to the left margin by sending a CR and spaces as needed.**

**Invalid parameters in SHF will result in an Invalid Parameter Error sense-code response to the control unit.**

## **SET LINE DENSITY (SLD)**

**EBCDIC=2BC6H**

The SLD code defines the current vertical lines-per-inch (LPI) setting. It specifies the distance to be moved for single-line vertical spacing commands such as LF or NL.

The SLD code is followed by up to two additional bytes. The first byte represents a one-byte binary count that indicates the total number of bytes following, including the count byte.

Valid count values are 01, 02. A count of 01 will set line density to the setting of Option 02, LINES PER INCH. A count of 02 with a following byte of 00 will set line density to the host default of 6 LPI.

The byte that follows the count byte specifies the vertical distance in standard typographic points (one point=1/72 inch). For example, the value for 6 LPI is 12, since  $72 \div 6 = 12$ .

Following are all of the possible valid SLD sequences:

2B C6 01.....	user LPI option setting
2B C6 02 00.....	6 LPI
2B C6 02 09.....	8 LPI
2B C6 02 0C.....	6 LPI .....(0CH=12 decimal)
2B C6 02 12.....	4 LPI .....(12H=18 decimal)
2B C6 02 18.....	3 LPI .....(18H=24 decimal)

An SLD change becomes effective immediately.

## NOTE

**3 and 4 LPI are accomplished by double spacing.**

**Any point values other than those shown above are invalid. Both invalid point values and invalid counts cause an Invalid Parameter Error response to the control unit for the data block containing the SLD sequence.**

## SET PRINT DENSITY (SPD)

**EBCDIC=2DB2H**

The SPD code defines the current horizontal characters-per-inch (CPI) setting.

The SPD code is followed by up to four additional bytes. The first byte represents a one-byte binary count that indicates the total number of bytes following, including the count byte.

Valid count values are 02 and 04. A count of 02 will set line density to the user CPI option setting. A count of 04 causes the last byte to represent the desired CPI setting.

The following are all of the possible valid SPD sequences:

2B D2 02 29.....	user CPI option setting
2B D2 04 29 00 00.....	10 CPI
2B D2 04 29 00 0A.....	10 CPI
2B D2 04 29 00 0C.....	12 CPI
2B D2 04 29 00 0F.....	15 CPI

An SPD change becomes effective immediately.



**NOTE**

**Any point values other than those shown above are invalid. Both invalid point values and invalid counts cause an Invalid Parameter Error response to the control unit for the data block containing the SPD sequence.**

**SET VERTICAL FORMAT (SVF)                    EBCDIC=2BC2H**

The SVF code defines the vertical format of the page. It includes the top and bottom margins, vertical tab stops, and maximum form length.

The SVF code is followed by a number of additional bytes. The first byte represents a one-byte binary count indicating the total number of bytes to follow, including the count byte.

The next three bytes following the count byte define the maximum page length (MPL) number, the top margin (TM), and the bottom margin (BM), respectively. Vertical tab-stop settings follow the bottom margin position. All values are expressed as one-byte binary numbers.

The minimum SVF sequence is three bytes long (SVF code plus a count of 01), which sets the vertical page format to the user option settings. The SVF sequence is:

(SVF) (count) (MPL) (TM) (BM) (T1) (T2)...(Tn)

- **MPL**—Defines a page length less than or equal to the maximum page length (255). If the MPL is set to a value greater than the physical page length, data may be printed beyond the page boundary. Whenever an SVF sequence is issued specifying a new MPL, the top of form (TOF) position is automatically reinitialized to line 1.
- **TM**—Specifies the line value used as the top presentation line on the page. The TM also serves as the first vertical tab stop. Valid TM values are less than or equal to the MPL. The TM default value is 1.
- **BM**—Specifies the line value that, if exceeded, causes an automatic skip to a new page. BM must be greater than or equal to TM and less than or equal to the MPL. The default BM value is the MPL value.
- **T1...Tn**—Vertical tab-stop settings. The tab stops do not have to be in order. Valid tab-stop values are less than or equal to the MPL.

## NOTE

Print position should be reinitialized after a SVF command by executing a Form Feed.

Invalid parameters in SVF will result in an Invalid Parameter Error sense code response to the control unit.

### TRANSPARENT DATA (TRN) EBCDIC=35H

The TRN code provides a method for transparent data transmission. A one-byte binary count follows the TRN code. It indicates the number of bytes of binary transparent data to follow, not including the count byte.

Transparent data is user-defined and is not scanned for SCS control codes. **Option 90, SCS TRANSLATE**, is provided to control the translation of the data received in SCS Transparent Mode. The data is either translated to ASCII with non-defined characters printed as hyphens or passed directly to the printer with no translation, depending on the setting of this option.

### VERTICAL CHANNEL SELECT (VCS) EBCDIC=04H

If **Option 37, VERTICAL CHANNEL SELECT SUPPORT**, is set to **0**, the VCS and the byte following are accepted and cause a Line Feed (LF) to be sent to the printer.

If **Option 37** is set to **1**, VCS moves the print position to a specific line number as defined by SVF (the set vertical format function). Vertical channels are defined by the top margin (TM) value and the first 11 vertical tab settings that were set with the SVF function.

Channel 1 is always set to the TM value (even if no vertical tabs are set). Vertical form movement does not alter the current horizontal print position.

The VCS sequence is: (SVF) (VS).

Byte VS selects one of the 12 channels for the vertical positioning. The following chart shows the available channel-select values.

**Table B-1. Channel Select Values.**

<b>Function</b>	<b>Byte VS</b>
Select Channel 1	81
Select Channel 2	82
Select Channel 3	83
Select Channel 4	84
Select Channel 5	85
Select Channel 6	86
Select Channel 7	87
Select Channel 8	88
Select Channel 9	89
Select Channel 10	7A
Select Channel 11	7B
Select Channel 12	7C

## NOTE

If no line stop values are assigned to a channel, a VCS function for that channel defaults to a line feed (LF) function.

If the select channel function specifies the current line number or specifies a number that is less than the current line number, forms move to the specified line of the next form.

An invalid select parameter will result in an Invalid Parameter Error sense-code response to the control unit.

### VERTICAL TAB (VT)

EBCDIC=0BH

The VT code moves the print position to the line specified by the next higher vertical tab stop. The VT code causes the appropriate number of line feeds to be sent to the printer to move the print position vertically to the next tab stop.

If there are no vertical tab stops below the current print position, a VT results in a single line feed. Vertical tab-stop positions are defined in the SVF (Set Vertical Format) function.

## B.3 Special SCS Code

### TRANSPARENT DATA (TRN)

EBCDIC=36H

SCS TRN code 36, defined by Xerox, is another method of transparent data transmission and is generally accepted for use in laser-printer applications. A one-byte binary count follows the TRN code. It indicates the number of bytes of binary transparent data to follow, not including the count byte.

Transparent data is user-defined and is not scanned for SCS control codes. The data is passed directly to the printer without translation.

# Appendix C: DSC Mode Printing

All of the configuration options referred to in this chapter can be altered at a host display station, at a serial-connected PC, or from the A/C-6 (RO)'s front panel controls.

## C.1 Host Software Considerations

When operating in DSC Mode, application data streams can be altered by host system software. Print-spooling programs such as RSCS, as well as system mapping support software in the host access method, can alter the data streams sent by application programs. Characters are validated; invalid characters are converted to valid printable characters and control codes such as NL, FF, EM; and attributes are inserted for formatting purposes. Legal characters are defined as the printable EBCDIC characters and do not include any control codes other than those discussed below.

## C.2 DSC Page Format

Two different printout formats are used in DSC Mode, formatted and unformatted. These two formats are controlled by the host software through use of the WCC (Write Control Character) in the data stream.

Maximum print area is determined by IBM page-format parameters in conjunction with your printer's page orientation and font characteristics. Page format defaults are determined by option settings for FORM LENGTH, LINE LENGTH, VERTICAL LINE DENSITY, and HORIZONTAL PRINT DENSITY.

During DSC printing, page format is considered fixed. These are the IBM format parameters:

### **Top Margin (TM)**

The first print line of a form. It is the top-of-form line. TM is always line 1 in DSC Mode and cannot be changed.

**Maximum Print Position (MPP)**

The rightmost print position of a form. MPP is determined by Option 06, LINE LENGTH, in unformatted DSC Mode and by the host in formatted DSC Mode.

**Maximum Page Length (MPL)**

MPL is the maximum number of vertical lines that can be printed on each form. MPL is determined by Option 05, FORM LENGTH, in DSC Mode.

**Left Margin (LM)**

The leftmost print position of a form. LM defaults to column 1 in DSC Mode and cannot be changed.

**Right Margin (RM)**

The rightmost print position, determined by MPP.

**Bottom Margin (BM)**

The last print line of a form. BM defaults to the MPL setting. It can be changed by setting Option 05, FORM LENGTH, to a new value and by changing Option 35, FORM FEED EMULATION, to 1.

**Formatted Print**

In a DSC formatted print, each line is the same length throughout the page. Line length can be specified as 40, 64, or 80 columns. Form feed is supported if encountered in the first print position of a line, but all other control codes (NL, CR, and EM) are printed as spaces.

Null lines may be either suppressed or printed as blank lines, according to the setting of Option 27, SUPPRESS NULL LINES. Null lines are those made up entirely of non-printable characters, attributes, nulls, spaces, and/or non-print fields.

Local copy screen prints, both operator-initiated and host-initiated, are DSC Mode formatted prints.

**Unformatted Print**

In a DSC unformatted print, line width is determined by the setting of Option 06, LINE LENGTH (up to 132 columns), and by control codes within the data stream. During unformatted printing, NL, CR, FF, and EM control codes are supported.

**C.3 DSC Control Codes**

During DSC unformatted printing, all control codes are supported. In a formatted print, form feed is supported, but all other control codes are printed as spaces. In non-print fields, all control codes are ignored except form feed.

The following control codes are supported in DSC Mode.

**NEW LINE (NL)****IDBCOD=03H**

The NL code moves the print position to the left-margin print position of the next line. It causes a CR, LF (Carriage Return, Line Feed) sequence to be sent to the printer.

If the current MPP (Maximum Print Position) is reached before an NL code is found in a print line, an automatic NL will occur unless Option 06, LINE LENGTH, is set to 0. The current MPP is defined by Option 06.

New Line codes occurring at or before the MPP will control line width and result in a single space. New Line codes occurring at MPP+1 will result in a double space, unless Option 29, NL AT MPP + 1, is set to 1.

NL codes are considered invalid if they occur in fields designated by non-print attributes or in formatted prints. In these cases, NL codes are printed as spaces and ignored.

**CARRIAGE RETURN (CR)****IDBCOD=05H****Table C-1. Print Position.**

<b>Function</b>	<b>EBCDIC</b>	<b>IDBCOD</b>	<b>Result</b>
NL New Line	15	03	First position next line
CR Carriage Return	0D	05	First position same line
FF Form Feed	0C	02	First position next form
EM End of Message	19	01	First position next line

CR codes are considered invalid if they occur in fields designated by non-print attributes or in formatted prints. In these cases, CR codes are printed as spaces and ignored.

CR codes occurring at MPP + 1 will result in an automatic NL being generated, and printing will resume at print-position one of the next line unless Option 28, CR AT MPP + 1, is set to 1.

**FORM FEED (FF)****ICDCOD=02H**

When a valid form-feed control code is encountered in the buffer, the form indexes to Top Margin of the next form and a space is inserted at Left Margin, unless Option 30, SPACE AFTER FORM FEED?, is set to 1.

There is no limit to the number of FF control codes that can be included in the printer buffer; neither is there a limit to the frequency of their occurrence. However, for an FF control code to be considered valid and thus initiate indexing, it must be properly placed. The FF character must be placed in buffer locations corresponding to the first position of a print line.

An FF control code in any other position of the printer buffer is considered invalid; the index operation is not executed, and the FF character prints as a space character unless Option 32, FORM FEED VALID, is set to 1.

If the FF control code is located at the end of the buffer or is followed by an EM code, the printer skips to line 2 of the next form unless Option 31, FORM FEED AT END OF BUFFER, is set to 1. Form Feeds that would result in blank forms are ignored regardless of Option 39, PRINT EMPTY FORM.



**END OF MESSAGE (EM)****IDBCOD=01H**

The EM codes terminates printing and moves the print position to the left margin print position of the next line unless Option 89, EM ACTION, is set to 0 or 2. It causes the output of a Carriage Return, Line Feed sequence to be sent to the printer and print processing terminates. Data following the EM code in the buffer is not printed.

EM codes are considered invalid if they occur in fields designated by non-print attributes or in formatted prints. In these cases, EM codes are printed as spaces and ignored.

If the buffer is not terminated with an EM code, it is still handled as if an EM code had terminated it.

## Appendix D: Character-Translation Tables

The A/C-6 (RO) provides flexible character translation to accommodate international languages, and a variety of ASCII printers and specialized applications. The A/C-6 (RO) uses three translate tables:

- SCS Character-Translation Table (EBCDIC to internal ASCII)
- DSC Character-Translation Table (IDBCOD to internal ASCII)
- Printer Character-Translation Table (internal ASCII to printer ASCII)

The first two tables convert the host computer's language into an internal ASCII used by A/C-6 (RO). (Only one of the first two tables is used, depending on which printing mode you are using.) The third table, the Printer Character Translate Table, is then used to determine the actual ASCII characters to send to the printer. These tables are described in **Sections D.2** through **D.4**.

Any or all characters in the Printer Character-Translation Table can be modified to match your ASCII printer's symbol set. Character-change options are described in **Sections D.6** through **D.8**.

International language support is covered in **Section D.5**.

**D.1 Character-Translation Overview**

The following diagrams show the flow of character translation in A/C-6 (RO):

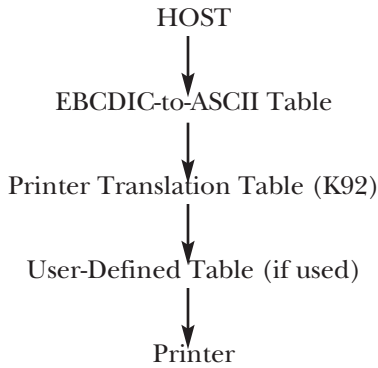
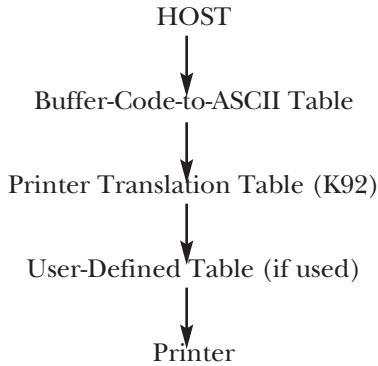
**SCS****DSC**

## Limitations

Although you cannot modify the EBCDIC-to-ASCII and Buffer-Code-to-ASCII tables, each host value is mapped to a unique ASCII hex value. To change the translation of a character:

1. Create a user-defined table (K71).
2. Overwrite the value to be changed with the new value (K75).
3. Associate the new table with the configuration preset to be used (K73), (K100, K101, K102).
4. Send the X1 global parameter save command to save the new translation table.

The adapter printer translation table (K92) should match the table configured on the printer. The four choices are 7-bit ASCII, ISO, Roman 8, and IBM PC.

## D.2 SCS Character-Translation Table

The SCS Character-Translation Table is used in all SNA Character String printing. All systems that communicate using SNA protocol (LU Type 1) between the host and its control units use this table.

This table is designed for translation from EBCDIC to internal ASCII. EBCDIC (Extended Binary-Coded Decimal Interchange Code) is the primary code set used in IBM systems. The EBCDIC-to-ASCII Translation table is shown in **Figures D-1** and **D-2**.

	0	1	2	3	4	5	6	7	8	9	A	B	C	D	E	F
0	NUL	-	-	-	Sp	&	-	ø	Ø	°	μ	^	{	}	\	0
1	-	-	-	-	é	/	É	a	j	~	£	A	J			1
2	-	-	-	-	â	ê	Â	Ê	b	k	s	¥	B	K	S	2
3	-	-	-	-	ä	ë	Ä	Ë	c	l	t	.	C	L	T	3
4	-	-	-	-	à	è	À	È	d	m	u	f	D	M	U	4
5	-	-	-	-	á	í	Á	Ì	e	n	v	§	E	N	V	5
6	-	-	-	-	ã	î	Ã	Î	f	o	w	¶	F	O	W	6
7	-	-	-	-	å	ï	Å	Ï	g	p	x	<sup>1/4</sup>	G	P	X	7
8	-	-	-	-	ç	ì	Ç	Í	h	q	y	<sup>1/2</sup>	H	Q	Y	8
9	-	-	-	-	ñ	ß	Ñ	ì	i	r	z	<sup>3/4</sup>	I	R	Z	9
A	-	-	-	-	ç	!		:	«	<sup>a</sup>	i	[	-	<sup>1</sup>	<sup>2</sup>	<sup>3</sup>
B	-	-	-	-	.	\$	,	#	»	<sup>o</sup>	¿	]	ô	û	Ô	Û
C	-	-	-	-	<	*	%	@	ð	æ	Đ	-	ö	ü	Ö	Ü
D	-	-	-	-	(	)	_	'	ý	,	Ý	"	ò	ù	Ò	Ù
E	-	-	-	-	+	;	>	=	p	Æ	þ	.	ó	ú	Ó	Ú
F	-	-	-	-		¬	?	"	±	€	R	=	õ	y	Õ	-

**Figure D-1. SCS (SNA LU1) EBCDIC to ASCII (Printable Character).**

	0	1	2	3	4	5	6	7	8	9	A	B	C	D	E	F
0	00	2D	2D	2D	20	26	2D	B7	97	DE	C2	53	7B	7D	5C	30
1	2D	2D	2D	2D	E7	AA	2F	8A	61	6A	7E	D1	41	4A	E6	31
2	2D	2D	2D	2D	A2	AB	82	8B	62	6B	73	D2	42	4B	53	32
3	2D	2D	2D	2D	A4	AC	84	8C	63	6C	74	CA	43	4C	54	33
4	2D	2D	2D	2D	A0	A9	80	89	64	6D	75	D5	44	4D	55	34
5	2D	2D	2D	2D	A1	AE	81	8E	65	6E	76	C8	45	4E	56	35
6	2D	2D	2D	2D	A3	AF	83	8F	66	6F	77	C9	46	4F	57	36
7	2D	2D	2D	2D	A5	B0	85	90	67	70	78	E3	47	50	58	37
8	2D	2D	2D	2D	A7	AD	87	8D	68	71	79	E4	48	51	59	38
9	2D	2D	2D	2D	B1	C3	91	60	69	72	7A	E5	49	52	5A	39
A	2D	2D	2D	2D	D0	21	7C	3A	CD	C0	C6	5B	E8	D7	D8	D9
B	2D	2D	2D	2D	2E	24	2C	23	CE	C1	C7	5D	B4	BC	94	9C
C	2D	2D	2D	2D	3C	2A	25	40	A8	A6	88	E0	B6	BD	96	9D
D	2D	2D	2D	2D	28	29	5F	27	BE	DC	9E	DF	B2	BA	92	9A
E	2D	2D	2D	2D	2B	3B	3E	3D	B8	86	98	DB	B3	BB	93	9B
F	2D	2D	2D	2D	CB	CC	3F	22	CF	D4	E1	E2	B5	BF	95	E9

Figure D-2. SCS (SNA LU1) EBCDIC to ASCII (Hex Character).

### **D.3 DSC Character-Translation Table**

This table is used for 3270 Data Stream Compatible printing in systems that communicate in bisynchronous line protocol between the host and control units. It is also used in SNA systems when LU Type 3 is employed. In addition, it is used when the control unit is a host local channel attached in a non-SNA system.

IDBCOD (Internal Device Buffer Code) is a hexadecimal code set used in DSC Mode only. It is sometimes referred to as buffer code. IDBCOD code locations 00 to 07 are reserved for format-control characters, and those above C0 (C0 to FF) are reserved for attributes. None of these can be used for print characters.

	0	1	2	3	4	5	6	7	8	9	A	B
0	NUL	Sp	0	&	à	ä	À	Ä	a	q	A	Q
1	Sp	=	1	–	è	ë	È	Ë	b	r	B	R
2	Sp	'	2	.	í	ï	Ì	Ï	c	s	C	S
3	Sp	"	3	,	ò	ö	Ò	Ö	d	t	D	T
4	Sp	/	4	:	ù	ü	Ù	Ü	e	u	E	U
5	Sp	\	5	+	ã	â	Ã	Â	f	v	F	V
6	Sp		6	¬	õ	ê	Õ	Ê	g	w	G	W
7	Sp		7	–	ÿ	î	Y	Î	h	x	H	X
8	>	?	8	°	à	ô	À	Ô	i	y	I	Y
9	<	!	9		è	û	È	Û	j	z	J	Z
A	]	\$	ß	^	é	á	É	Á	k	æ	K	Æ
B	[	ç	§	~	ì	é	Ì	É	l	ø	L	Ø
C	)	£	#	”	ò	ì	Ò	Í	m	å	M	Å
D	(	¥	@	'	ù	ó	Ù	Ó	n	ç	N	Ç
E	}	Pts	%	'	ü	ú	Y	Ú	o	†	O	;
F	{	€	_	,	ç	ñ	C	Ñ	p	* <sup>~</sup>	P	*

Figure D-3. DSC IBDCOD to ASCII (Printable Character).



	<b>0</b>	<b>1</b>	<b>2</b>	<b>3</b>	<b>4</b>	<b>5</b>	<b>6</b>	<b>7</b>	<b>8</b>	<b>9</b>	<b>A</b>	<b>B</b>
<b>0</b>	00	20	30	26	A0	A4	80	84	61	71	41	51
<b>1</b>	20	3D	31	2D	A9	AC	89	8C	62	72	42	52
<b>2</b>	20	27	32	2E	AD	B0	8D	90	63	73	43	53
<b>3</b>	20	22	33	2C	B2	B6	92	96	64	74	44	54
<b>4</b>	20	2F	34	3A	BA	BD	9A	9D	65	75	45	55
<b>5</b>	20	5C	35	2B	A3	A2	83	82	66	76	46	56
<b>6</b>	20	CB	36	CC	B5	AB	95	8B	67	77	47	57
<b>7</b>	20	7C	37	E0	BF	AF	F3	8F	68	78	48	58
<b>8</b>	3E	3F	38	DE	EB	B4	F4	94	69	79	49	59
<b>9</b>	3C	21	39	EA	EC	BC	F5	9C	6A	7A	4A	5A
<b>A</b>	5B	24	C3	5E	ED	A1	F6	81	6B	A6	4B	86
<b>B</b>	5D	D0	C8	7E	EE	AA	F7	8A	6C	B7	4C	97
<b>C</b>	29	D1	23	DF	EF	AE	F8	8E	6D	A5	4D	85
<b>D</b>	28	D2	40	60	F0	B3	F9	93	6E	A7	4E	87
<b>E</b>	7D	D3	25	DB	F1	BB	FA	9B	6F	C4	4F	3B
<b>F</b>	7B	D4	5F	DC	F2	B1	FB	91	70	C5	50	2A

**Figure D-4. DSC IDBCOD to ASCII (Hex Character).**

## **D.4 Printer Character-Translation Table**

All characters destined for the printer and not created by any transparency method pass through the active Printer Character-Translation Table. This table translates A/C-6 (RO)'s internal ASCII to the ASCII codes used by the printer.

Printer Character-Translation Table code locations 00 to 7F are standard ASCII values for all printers. Locations 00 to 1F are reserved for control characters. None of these can be used for print characters. In locations above 7F (80 to FF) will be the character codes specific to the target printer. These characters include the IBM characters that have no standard ASCII equivalent, such as the logical not and the cent sign. Also included in the table are the national language characters and other special characters.

The A/C-6 (RO) has four Printer Character Translate Tables resident in firmware:

- Extended 7-bit ASCII (default)
- ISO
- Roman-8
- IBM-PC

	0	1	2	3	4	5	6	7	8	9	A	B	C	D	E	F
0	NUL		Sp	0	@	P	`	p	A	l	a	i	a	c	Sp	u
1			!	1	A	Q	a	q	A	N	a	n	o	Sp	R	u
2			"	2	B	R	b	r	A	O	a	o	Sp	Y	-	c
3			#	3	C	S	c	s	A	O	a	o	Sp	Sp	Sp	Y
4			\$	4	D	T	d	t	A	O	a	o	;	Sp	Sp	A
5			%	5	E	U	e	u	A	O	a	o	*	f	Sp	E
6			&	6	F	V	f	v	Sp	O	Sp	o	!	Sp	Sp	E
7			'	7	G	W	g	w	C	O	c	o	?	1	Sp	l
8			(	8	H	X	h	x	D	P	d	p	Sp	2	-	O
9			)	9	I	Y	i	y	E	NUL	e	NUL	Sp	3	-	U
A			*	:	J	Z	j	z	E	Ü	e	u	Sp	NUL	Sp	Y
B			+	;	K	[	k	{	E	U	e	u		'	a	C
C			,	<	L	\	l		E	U	e	u	^	,	e	
D			-	=	M	]	m	}	l	U	i	u	<	^	e	
E			.	>	N	^	n	~	l	Y	i	y	>	Sp	i	
F			/	?	O	_	o	NUL	l	Y	i	y	Sp	Sp	o	

**Figure D-5. ASCII-7 (Printable Character).**

	0	1	2	3	4	5	6	7	8	9	A	B	C	D	E	F
0	00	10	20	30	40	50	60	70	41	49	61	69	61	63	20	75
1	01	11	21	31	41	51	61	71	41	4E	61	6E	6F	20	52	75
2	02	12	22	32	42	52	62	72	41	4F	61	6F	20	59	2D	63
3	03	13	23	33	43	53	63	73	41	4F	61	6F	20	20	20	59
4	04	14	24	34	44	54	64	74	41	4F	61	6F	3B	20	20	41
5	05	15	25	35	45	55	65	75	41	4F	61	6F	2A	66	20	45
6	06	16	26	36	46	56	66	76	20	4F	20	6F	21	20	20	45
7	07	17	27	37	47	57	67	77	43	4F	63	6F	3F	31	20	49
8	08	18	28	38	48	58	68	78	44	50	64	70	20	32	2D	4F
9	09	19	29	39	49	59	69	79	45	00	65	00	20	33	2D	55
A	0A	1A	2A	3A	4A	5A	6A	7A	45	55	65	75	20	00	20	59
B	0B	1B	2B	3B	4B	5B	6B	7B	45	55	65	75	7C	27	61	43
C	0C	1C	2C	3C	4C	5C	6C	7C	45	55	65	75	5E	2C	65	00
D	0D	1D	2D	3D	4D	5D	6D	7D	49	55	69	75	3C	5E	65	00
E	0E	1E	2E	3E	4E	5E	6E	7E	49	59	69	79	3E	20	69	00
F	0F	1F	2F	3F	4F	5F	6F	00	49	59	69	79	20	20	6F	00

Figure D-6. ASCII-7 (Hex Character).

	0	1	2	3	4	5	6	7	8	9	A	B	C	D	E	F
0	NUL		Sp	0	@	P	`	p	À	Ĭ	à	ï	ª	¢	-	ù
1			!	1	A	Q	a	q	Á	Ñ	á	ñ	º	£	R	ü
2			"	2	B	R	b	r	Â	Ò	â	ò	µ	¥	-	ç
3			#	3	C	S	c	s	Ã	Ó	ã	ó	β	Sp	1/4	ÿ
4			\$	4	D	T	d	t	Ä	Ô	ä	ô	;	€	1/2	À
5			%	5	E	U	e	u	Å	Õ	å	õ	*	f	3/4	E
6			&	6	F	V	f	v	Æ	Ö	æ	ö	ı	Sp	Sp	E
7			'	7	G	W	g	w	Ç	Ø	ç	ø	ı	1	Sp	I
8			(	8	H	X	h	x	Ð	Þ	ð	þ	§	2	-	O
9			)	9	I	Y	i	y	È	NUL	è	NUL	¶	3	-	U
A			*	:	J	Z	j	z	É	Ú	é	ú	.	NUL	Sp	ÿ
B			+	;	K	[	k	{	Ê	Û	ê	û		'	à	C
C			,	<	L	\	l	ı	Ë	Ü	ë	ü	¬	,	è	
D			-	=	M	]	m	}	Ì	Û	ì	ü	«	^	é	
E			.	>	N	^	n	~	Í	Ý	í	ý	»	º	ì	
F			/	?	O	_	o	NUL	Î	Ÿ	î	ÿ	±	”	ò	

**Figure D-7. ISO (Printable Character).**

	0	1	2	3	4	5	6	7	8	9	A	B	C	D	E	F
0	00	10	20	30	40	50	60	70	C0	CF	E0	EF	AA	A2	AF	F9
1	01	11	21	31	41	51	61	71	C1	D1	E1	F1	BA	A3	52	FC
2	02	12	22	32	42	52	62	72	C2	D2	E2	F2	B5	A5	2D	E7
3	03	13	23	33	43	53	63	73	C3	D3	E3	F3	DF	20	BC	59
4	04	14	24	34	44	54	64	74	C4	D4	E4	F4	3B	A4	BD	41
5	05	15	25	35	45	55	65	75	C5	D5	E5	F5	2A	66	BE	45
6	06	16	26	36	46	56	66	76	C6	D6	E6	F6	A1	20	20	45
7	07	17	27	37	47	57	67	77	C7	D7	E7	F8	BF	B9	20	49
8	08	18	28	38	48	58	68	78	D0	DE	F0	FE	A7	B2	2D	4F
9	09	19	29	39	49	59	69	79	C8	00	E8	00	B6	B3	2D	55
A	0A	1A	2A	3A	4A	5A	6A	7A	C9	D9	E9	F9	B7	00	20	59
B	0B	1B	2B	3B	4B	5B	6B	7B	CA	DA	EA	FA	7C	B4	E0	43
C	0C	1C	2C	3C	4C	5C	6C	7C	CB	DB	EB	FB	AC	B8	E8	00
D	0D	1D	2D	3D	4D	5D	6D	7D	CC	DC	EC	FC	AB	5E	E9	00
E	0E	1E	2E	3E	4E	5E	6E	7E	CD	DD	ED	FD	BB	B0	EC	00
F	0F	1F	2F	3F	4F	5F	6F	00	CE	59	EE	FF	B1	A8	F2	00

Figure D-8. ISO (Hex Character).

	0	1	2	3	4	5	6	7	8	9	A	B	C	D	E	F
0	NUL		Sp	0	@	P	`	p	À	Ĭ	à	ï	ª	¢	–	ù
1			!	1	A	Q	a	q	Á	Ñ	á	ñ	º	£	R	ü
2			"	2	B	R	b	r	Â	Ò	â	ò	µ	¥	–	ç
3			#	3	C	S	c	s	Ã	Ó	ã	ó	ß	Sp	1/4	ÿ
4			\$	4	D	T	d	t	Ä	Ô	ä	ô	;	€	1/2	À
5			%	5	E	U	e	u	Å	Õ	å	õ	*	f	3/4	E
6			&	6	F	V	f	v	Æ	Ö	æ	ö	ı	Sp	Sp	E
7			'	7	G	W	g	w	Ç	Ø	ç	ø	¿	1	Sp	I
8			(	8	H	X	h	x	Ð	Þ	ð	þ	§	2	–	O
9			)	9	I	Y	i	y	È	NUL	è	NUL	¶	3	–	U
A			*	:	J	Z	j	z	É	Ú	é	ú	.	NUL	Sp	ÿ
B			+	;	K	[	k	{	Ê	Û	ê	û		'	à	C
C			,	<	L	\	l		Ë	Ü	ë	ü	¬	,	è	
D			-	=	M	]	m	}	Ì	Û	ì	ü	«	^	é	
E			.	>	N	^	n	~	Í	Ý	í	ý	»	º	ì	
F			/	?	O	_	o	NUL	Î	Ý	î	ÿ	±	"	ò	

**Figure D-9. ROMAN-8 (Printable Character).**

	0	1	2	3	4	5	6	7	8	9	A	B	C	D	E	F
0	00	10	20	30	40	50	60	70	A1	A7	C8	DD	F9	BF	B0	CB
1	01	11	21	31	41	51	61	71	E0	B6	C4	B7	FA	BB	52	CF
2	02	12	22	32	42	52	62	72	A2	E8	C0	CA	F3	BC	2D	B5
3	03	13	23	33	43	53	63	73	E1	E7	E2	C6	DE	20	F7	59
4	04	14	24	34	44	54	64	74	D8	DF	CC	C2	3B	BA	F8	41
5	05	15	25	35	45	55	65	75	D0	E9	D4	EA	2A	BE	F5	45
6	06	16	26	36	46	56	66	76	D3	DA	D7	CE	B8	20	20	45
7	07	17	27	37	47	57	67	77	B4	D2	B5	D6	B9	31	20	49
8	08	18	28	38	48	58	68	78	E3	F0	E4	F1	BD	32	2D	4F
9	09	19	29	39	49	59	69	79	A3	00	C9	00	F4	33	2D	55
A	0A	1A	2A	3A	4A	5A	6A	7A	DC	AD	C5	CB	F2	A9	20	59
B	0B	1B	2B	3B	4B	5B	6B	7B	A4	ED	C1	C7	7C	A8	C8	43
C	0C	1C	2C	3C	4C	5C	6C	7C	A5	AE	CD	C3	5E	2C	C9	00
D	0D	1D	2D	3D	4D	5D	6D	7D	E6	DB	D9	CF	FB	AA	C5	00
E	0E	1E	2E	3E	4E	5E	6E	7E	E5	B1	D5	B2	FD	B3	D9	00
F	0F	1F	2F	3F	4F	5F	6F	00	A6	59	D1	EF	FE	AB	CA	00

Figure D-10. ROMAN-8 (Hex Character).



	0	1	2	3	4	5	6	7	8	9	A	B	C	D	E	F
0	NUL		Sp	0	@	P	`	p	À	Ì	à	ï	<sup>a</sup>	ç	Sp	ù
1			!	1	A	Q	a	q	À	N	á	ñ	°	£	R	ü
2			"	2	B	R	b	r	A	O	â	ò	μ	¥	–	ç
3			#	3	C	S	c	s	A	O	ã	ó	β	Sp	1/4	ÿ
4			\$	4	D	T	d	t	Ä	O	ä	ô	;	Sp	1/2	À
5			%	5	E	U	e	u	Å	Õ	å	õ	*	f	Sp	È
6			&	6	F	V	f	v	Æ	Ö	æ	ö	ı	Sp	Sp	É
7			'	7	G	W	g	w	Ç	O	ç	ø	ı	1	Sp	Ì
8			(	8	H	X	h	x	D	P	d	p	§	2	–	O
9			)	9	I	Y	i	y	E	NUL	è	NUL	Sp	3	–	U
A			*	:	J	Z	j	z	É	U	é	ú	.	NUL	Sp	ÿ
B			+	;	K	[	k	{	E	U	ê	û		'	à	C
C			,	<	L	\	l		E	U	ë	ù	¬	,	è	
D			-	=	M	]	m	}	I	U	ì	ü	«	^	é	
E			.	>	N	^	n	~	I	Y	í	y	»	°	ì	
F			/	?	O	_	o	NUL	I	Y	î	ÿ	±	Sp	ò	

**Figure D-11. IBM-PC (Printable Character).**

	0	1	2	3	4	5	6	7	8	9	A	B	C	D	E	F
0	00	10	20	30	40	50	60	70	41	49	85	8B	A6	9B	20	97
1	01	11	21	31	41	51	61	71	41	4E	A0	A4	A7	9C	52	81
2	02	12	22	32	42	52	62	72	41	4F	83	95	E6	9D	2D	87
3	03	13	23	33	43	53	63	73	41	4F	61	A2	E1	20	AC	59
4	04	14	24	34	44	54	64	74	8E	4F	84	93	3B	20	AB	41
5	05	15	25	35	45	55	65	75	8F	4F	86	6F	2A	9F	20	45
6	06	16	26	36	46	56	66	76	92	4F	91	94	AD	20	20	45
7	07	17	27	37	47	57	67	77	80	4F	87	ED	A8	31	20	49
8	08	18	28	38	48	58	68	78	44	50	64	70	15	32	2D	4F
9	09	19	29	39	49	59	69	79	45	00	8A	00	20	33	2D	55
A	0A	1A	2A	3A	4A	5A	6A	7A	90	55	82	97	FA	00	20	59
B	0B	1B	2B	3B	4B	5B	6B	7B	45	55	88	A3	B3	27	85	43
C	0C	1C	2C	3C	4C	5C	6C	7C	45	55	89	96	AA	2C	8A	00
D	0D	1D	2D	3D	4D	5D	6D	7D	49	55	8D	81	AE	5E	82	00
E	0E	1E	2E	3E	4E	5E	6E	7E	49	59	A1	79	AF	F8	8D	00
F	0F	1F	2F	3F	4F	5F	6F	00	49	59	8C	98	F1	20	95	00

Figure D-12. IBM-PC (Hex Character).

## **D.5 International Language Changes**

A/C-6 (RO) allows printing in the character sets of different countries by providing the same choices offered in 3X74 control-unit customization.

For national-language customization of the control unit, refer to the *IBM 3X74 Control Unit Description and Programmer's Guide*.

In the control unit, customization-sequence question number 121, Keyboard Language and Character Set I/O Interface Code, is used to specify the national character set. The same language used for the CU should be used when setting Option 08, LU1 LANGUAGE. Note that the numbers used in this option may differ from those used in the control unit, depending on the control unit used.

In DSC Mode, national language conversion is done in the control unit. The country character set used in DSC Mode is determined by control-unit customization. In SCS Mode, national language conversion is done in A/C-6 (RO). The LU1 LANGUAGE option determines the country character set in SCS Mode.

For a list of selectable international languages, see the LU1 LANGUAGE parameter in **Appendix A**.

## **D.6 Individual Character Changes**

Any character shown in the selected Printer Character-Translation Table can be changed. You can print a character not defined in any of the IBM language character sets or print one of the defined characters by using a different code.

Six configuration commands allow you control over character translation. With the exception of LU1 Language (Host Definition menu), all the commands listed below can be found in the Editors menu in front-panel configuration mode.

Editors-menu commands are listed on the next page. An example follows. If you do not require more than one Printer Character-Translation Table (if you have only one printer) you will only need to use two commands. Choose one of the four Printer Character-Translation Tables and apply it to User Table 1 (default). Then modify individual ASCII character translations.

## NOTE

Like all configuration changes, changes made in the Editors menu must be saved to a preset before you exit configuration mode, otherwise they will be lost. This does not mean that User Tables need to be created for every preset. Any table can be assigned to any preset. See Chapter 4 and Appendix A for more on configuration presets.

If you wish to create more than one User Table, you must create each table (assign it a place in EEPROM). These tables can then be selected, applied to, modified, and/or deleted.

### LU1 Language

Select the language that matches that of the host control unit. The default is US EBCDIC.

### Apply To Table

Select one of four Printer Character Translation Tables (see **Section D.4**) and assign it to the selected User Table.

### Modify Table

Modify individual internal-ASCII-to-printer-ASCII character translations (20 to FF hex only).

### Create Table

Allocate space and deploy the 7-bit ASCII table for the designated number. This command will overwrite an existing table. A/C-6 (RO) can accept up to 8 user tables. All but User Table 1 must be created with this command.

### Delete Table

Delete User Table n from the existing tables and release the EEPROM space that User Table n was occupying. User Table 1 cannot be deleted.

### Select Table

Select User Table n to be the active translation table. Use this command to bring up a previously created table (and then go on to apply to and modify that table). This command will only show User Tables that have been created.

## D.7 Translation Example

The example below shows how character translation options might be used to change the British pound sign £ (9CH) to the dollar sign \$ (24H) using the front-panel configuration methods explained in **Section 5.2**.

For the purposes of illustration, this example saves the changes to User Table 2, a table that is based on the Roman-8 character set. Most users would only ever need one set of translations, and would therefore save their changes to the default, User Table 1.

Refer to **Section 5.2** if you do not remember how to operate A/C-6 (RO) from the front panel in configuration mode.

1. Access configuration mode and enter the Editors menu. Locate and enter the Create Table command. Locate User Table 2 and press <ADVANCE Right Arrow>. You have just created User Table 2 with 7-bit ASCII (Figures D-5 and D-6).
2. Locate and enter the Select Table command. Locate User Table 2 and press <ADVANCE Right Arrow>. Locate and enter the Apply To Table command. Locate Roman-8 and press <ADVANCE Right Arrow>.
3. Locate and enter the Modify Table command. Scroll with <SELECT Up Arrow> or <SELECT Down Arrow> until you locate hex code 9C. Your display should read:

```
Modify Table  
9C : 55
```

4. Use the <ADVANCE Right Arrow> button to move the cursor to the other side of the equation. Again use the SELECT Up or Down buttons to locate hex code 24. Press <ADVANCE Right Arrow>.
5. Locate and enter the Utilities menu. Use the Save Preset command to save your changes to any of the eight configuration presets.

# Appendix E: Transparent Data Transfer

The A/C-6 (RO) supports several methods of transparent data transfer to allow printer-control data to pass through the IBM system without interpretation or modification by the system. Escape sequences, character font download streams, and raster-graphics data streams are all examples of data that normally cannot be sent through an IBM system but that can be sent using methods of transparent data transfer.

## E.1 Hex Transfer Method

The A/C-6 (RO) supports a method of transferring transparent data that can be used in both DSC and SCS Modes. In this method, called Hex Transfer, hex data is passed entirely as printable characters; neither host software nor communication paths are disturbed. There are two modes of Hex Transfer: delimited and formatted. These modes are described in **Section E.2**.

Hex Transfer is not an IBM standard method, but it is a technique that can be used with all IBM systems and that has achieved wide acceptance.

### NOTE

**In SCS Mode, the SCS Transparency technique is also available. See Section E.5.**

Hex transfer is necessary to support raster graphics and font downloads (binary data), and is the preferred method of transmitting escape sequences. Hex transfer uses two EBCDIC bytes to transmit each 8 bits of data. Pairs of printable EBCDIC characters are sent from the application to A/C-6 (RO), where they are decoded into single 8-bit codes and sent to the printer.

Each byte of data to be sent transparently to the printer, whether a character or binary data, must be encoded by the application program into its hex representation. This two-character representation has a range of 00 to FF, and always comprises a pair of characters from the set 0 through 9 plus A through F. As all of these characters are always printable, the IBM system will not intercept them regardless of the value represented. A/C-6 (RO), operating in Hex Transfer Mode, will accept these pairs of characters and decode them back into the desired 8-bit values. These values are then sent to the printer.

**NOTE**

While A/C-6 (RO) is operating in Hex Transfer Mode, only the characters 0-9 and A-F are accepted. Other characters are considered errors. Errors encountered in the data stream will cause immediate termination of this mode, and the rejected character will not be displayed. Spaces or commas can be included to make these sequences more legible within a host program.

The asterisk (\*) character has a special meaning in identifying data compression (see Section E.3).

**Binary Data Transmission**

Graphical data and printer fonts must be sent to the printer in binary form. Since this data contains arbitrary bit patterns (such as 0000 0000), it must be transferred transparently. The example below shows how each byte of data is encoded, transmitted, and decoded. The Hex Transfer prefix and suffix have been omitted from the example.

```

Binary data stream .....00011010|00000000
Characters sent by host .....1 A    0 0
Characters received by A/C-6 (RO) .....1 A 0 0
A/C-6 (RO) recombines characters to
form hex values and converts them
to binary .....1 A    0 0
Binary data stream .....00011010|00000000

```

**Text with Escape Sequences**

Two methods are available to send escape sequences to access printer features. The simplest method is to define an EBCDIC or buffer-codes character to be translated to the ASCII ESC code, then send the escape sequences as normal text. This method allows the escape sequence to be interpreted by the printer.

It will, however, cause a problem in DSC Mode. When A/C-6 (RO) receives data from the system, it counts the characters in order to determine line length. When the count reaches the specified line length, A/C-6 (RO) will insert an NL code. Since A/C-6 (RO) will count the escape sequences as characters, these NL codes will cause premature new lines (lines with embedded escape sequences will print shorter than expected).

For example, assume the following line (which contains escape sequences to print some bold text) is sent to a HP LaserJet printer:

This line of text contains escape sequences to print bold.  
This is the following line...

The data transmitted to accomplish this is as follows:

This line of text  $\text{E}_C(\text{s}3\text{B}$  contains  $\text{E}_C(\text{s}0\text{B}$  escape sequences to print bold.  
This is the following line...

For this example, assume that a redefined escape character is used and the escape sequence is sent as normal text in formatted DSC Mode with a line length of 60. Since A/C-6 (RO) counts all characters to determine the line length and cannot distinguish escape sequence characters from printed text, it includes the escape sequences in the count. The result is that A/C-6 (RO) inserts an NL before the normal end of the line. This would result in the lines being printed as follows.

This line of text **contains** escape sequences to print bold.  
This is the following line...

SCS Mode will have a similar problem if line length appears to exceed 132 characters.

## NOTE

**Setting Option 06, LINE LENGTH, to 0 will correct the problem of undesired line wraps. However, if DSC Mode is being used, Option 89, EM ACTION, should probably be set to 0 to avoid automatic new line or automatic form feed. Also, Option 110, MICRO ADJUST, should be disabled.**

It is preferable to use Hex Transfer to avoid undesired line wraps in the text. Characters in Hex Transfer Mode are not included in the line length count. The following shows how Delimited Mode could be used to send the escape sequence to start bold print on a HP LaserJet printer. The ASCII hex representation of the characters in the escape sequence is required.

Character:..... $\text{E}_C ( s 3 B$   
Hex sequence:.....1B 28 73 33 42



For the purpose of this example, we will assume that the A/C-6 (RO) has been configured to use the two-character sequence \$\$ as the Delimited Hex Transfer prefix and the single character Z as the suffix. The following shows how the transmission is accomplished.

```

Effect desired .....START BOLD PRINT
Escape sequence .....E C ( s 3 B
Encoded version sent .....$$ 1B 28 73 33 42 Z
to A/C-6 (RO)
Received by A/C-6 (RO) .....$ $ 1 B 2 8 7 3 3 3 4 2 Z
Decoded by A/C-6 (RO) .....1B 28 73 33 42
Received by printer.....E C ( s 3 B
Action by printer .....START BOLD PRINT

```

A/C-6 (RO) interprets the 13 characters in the example above to be, respectively, the hex-transfer prefix, five 2-byte EBCDIC character pairs to be converted to ASCII codes, and the hex-transfer suffix. It strips off the prefix and suffix characters, translates and compresses the EBCDIC character pairs to form the five desired ASCII characters, then sends them to the printer.

## E.2 Two Modes of Hex Transfer

Two different modes of Hex Transfer are supported: delimited and formatted.

Delimited Hex Transfer uses a special sequence to mark the beginning and end of hex data. A unique character sequence is used as a prefix to the hex-transfer data, and another serves as the hex-transfer suffix.

<Prefix><byte pair><byte pair>...<byte pair><Suffix>

Formatted Hex Transfer supports two modes: single-byte and counted. The method is the same, except that Single-Byte Hex Transfer has an implied count of 1. In general, Formatted Hex Transfer uses a special sequence to mark the beginning of hex data, and a count is used to determine the end. A unique character sequence is used as a prefix followed by a count (in hex-transfer byte-pair fashion), which is then followed by the hex data. In this case, Hex Transfer Mode stays in effect until the count is exhausted.

<Prefix><Hex Count pair><byte pair><byte pair>...<byte pair>

Delimited or Formatted Hex Transfer may be enabled at any time. The special character sequences used to mark hex-transfer data are user-defined.

A hex-transfer method is enabled by defining its trigger character sequence(s). These can be made up of any printable characters. Character sequences used as a trigger to hex transfer may be up to eight characters long.

## NOTE

**To ensure correct operation, the Delimited Hex Transfer prefix and the Formatted Hex Transfer prefix must have different character sequences.**

### Delimited Hex Transfer

Delimited Hex Transfer uses a unique character sequence as a prefix trigger at the beginning of hex-transfer data and another at the end to serve as a suffix. Delimited Hex Transfer allows unlimited length transparent data transfer.

You can customize the characters to be used for the prefix and suffix triggers for Delimited Hex Transfer data. By defining the trigger characters, Delimited Hex Transfer Mode is enabled. A string of up to eight characters may be defined as the prefix, while any one character can be specified as the suffix. Any printable characters may be used.

For example, a string of five left square bracket characters could be defined as the Delimited Hex Transfer prefix, and a single right bracket for the suffix. A Delimited Hex Transfer sequence would then look like this:

```
[[[[[<byte pair><byte pair>...<byte pair>]]]]
```

The following is an example of how Delimited Hex Transfer is used to select portrait page orientation on an HP LaserJet printer. The escape sequence is  $\text{E}^{\text{C}} \& 10 \text{O}$ . The corresponding hex codes are 1B 26 6C 30 4F. With the Delimited Hex Transfer prefix defined as in the example above, you will enter the following character string in a print file:

```
[[[[[1B266C304F]]]]
Effect desired .....PORTRAIT MODE
Escape Sequence ..... $\text{E}^{\text{C}} \& 10 \text{O}$ 
delimited mode prefix .....[[[[[
delimited mode suffix .....]]]]
Encoded version sent to A/C-6 (RO).....[[[[[1B266C304F]]]]
Received by A/C-6 (RO) .....[[[[[1B266C304F]]]]
Decoded by A/C-6 (RO) .....1B266C304F
Received by printer..... $\text{E}^{\text{C}} \& 10 \text{O}$ 
Action by printer .....PORTRAIT MODE
```

A/C-6 (RO) interprets this character string as the Delimited Hex Transfer prefix, five character pairs to be converted to ASCII codes and the Delimited Hex Transfer suffix. It strips off the prefix and suffix characters, compresses the character pairs to form the five desired ASCII characters and sends them to the printer.

Two consecutive instances of the currently defined trigger character can also be used to initiate Delimited Hex Transfer. In this case, a single instance of the trigger character must be used as the Delimited Hex Transfer suffix.

The following is an example of how Delimited Hex Transfer is used to select double-sided printing on an HP LaserJet IID printer using the currently defined trigger character to initiate the sequence. The escape sequence for double-sided printing (Duplex, long-edge binding Mode) is `ESC C&11S`. The corresponding hex codes are 1B 26 6C 31 53. You would enter the following character string in a print file:

```
&&??% %% 1B266C3153%&&??<Space>
```

```
&& ??% .....Define % as the trigger character
%% 1B 26 6C 31 53% .....Initiate Duplex, long-edge binding Mode
&&??<Space> .....Clear trigger character
```

To turn off double-sided printing, you would enter the following character string in a print file:

```
&&??% %% 1B266C3053%&&??<Space>
```

```
&&??% .....Define % as the trigger character
%% 1B 26 6C 30 53 % .....Initiate Simplex Mode (single-sided printing)
&&??<Space> .....Clear trigger character
```

**Formatted Hex Transfer: Counted**

Counted Hex Transfer uses a unique character sequence as a prefix trigger followed by a count representing the number of hex transfer byte pairs to follow. The count does not include the count byte pair itself.

For Counted Hex Transfer to be used, Option 47, FORMATTED HEX TRANSFER SELECT, must be set to 2.

Counted Hex Transfer Mode stays in effect until the count is exhausted. Counted Hex Transfer is limited to transparent sequences of 256 byte pairs or less.

You can customize the characters to be used for the prefix to Counted Hex Transfer data. By defining the trigger character or characters, Counted Hex Transfer is enabled. A string of up to eight characters may be defined. Any printable characters may be used.

For example, a string of five left curled brace characters could be used as the Counted Hex Transfer prefix. A Counted Hex Transfer sequence would then look like this:

```
{}{}{}{}{}<count pair><byte pair><byte pair>...<byte pair>
```

## NOTE

**A count of 0 cannot be used for Counted Hex Transfer.**

Below is an example of how Counted Hex Transfer is used to select landscape page orientation on an HP LaserJet printer. The escape sequence is  $\text{E}^{\text{C}} \& 11 \text{O}$ . The corresponding hex codes are 1B 26 6C 31 4F. With the Counted Hex Transfer prefix defined as in the preceding example, you would enter the following character string in a print file:

```
{ {} {} {} {} 0 5 1 B 2 6 6 C 3 1 4 F
```

```
Effect desired.....LANDSCAPE MODE
Escape Sequence ..... $\text{E}^{\text{C}} \& 11 \text{O}$ 
Counted prefix .....{}{}{}{}{}
count of following byte pairs .....05
Encoded version sent to A/C-6 (RO) .....{}{}{}{}{} 05 1B 26 6C 31 4F
Received by A/C-6 (RO) .....{ {} {} {} {} 0 5 1 B 2 6 6 C 3 1 4 F
Decoded by A/C-6 (RO) .....1 B 2 6 6 C 3 1 4 F
Received by printer ..... $\text{E}^{\text{C}} \& 11 \text{O}$ 
Action by printer .....LANDSCAPE MODE
```

A/C-6 (RO) interprets this character string as the Counted Hex Transfer prefix, the count of byte pairs to follow, and five character pairs to be converted to ASCII codes. It strips off the prefix, validates the count, compresses the character pairs to form the five desired ASCII characters and sends them to the printer.

**Formatted Hex Transfer: Single Byte**

Single-Byte Hex Transfer is the same method as Counted Hex Transfer, but it uses an implied count of 1.

For Single-Byte Hex Transfer to be used, Option 47, FORMATTED HEX TRANSFER SELECT, must be set to 1.

For example, a string of five left curled brace characters could be used as the Single-Byte Hex Transfer prefix trigger. A Single Byte Hex Transfer sequence would then look like this:

```
{}{}{}{}{}<byte pair>
```

**NOTE**

**A single instance of the currently defined trigger character can be used to initiate Formatted Hex Transfer.**

```
&&??% .....Define % as trigger character
%1B .....Output and ESC to the printer
&&??<Space>.....Clear trigger character
```

**Data Compression**

When in Delimited Hex Transfer Mode, it is possible to increase the speed of binary data transfer. Data compression can be especially useful in graphics applications when sending all-white or all-black areas of an image to the printer. Data is compressed in the host, sent as compressed data through the system, then expanded by A/C-6 (RO).

**NOTE**

**This feature complies with the data-compression requirements of the MD-GRAFTEXT and MD-LASER host software packages from MAERSK DATA A/S and ACX-TEND from ACX Software.**

A special sequence is embedded within any Delimited Hex Transfer that identifies a single byte and the number of times that byte must be sent to the printer.

A data-compression sequence is made up of a count, a compression trigger character, and the data to be expanded. The count is sent as a hex-transfer byte, the compression trigger is an asterisk (\*) character and the data to be repeated is sent as a hex-transfer pair. A data-compression sequence looks like this:

<Hex Count>\*<byte pair to be repeated>

The following is an example of a data compression sequence that sends eight null bytes to the printer. This example uses Delimited Hex Transfer with the same triggers shown in earlier examples.

```

[[[[[ 08 * 00 ]
prefix .....[[[[[
suffix .....]
Compression count.....08
Trigger for compression.....*
Data to be expanded .....00
Received by printer.....8 null bytes

```

## NOTE

The count may be either one or two hex digits. For counts of 15 (in hex form an F) or less, a single digit may be used.

Whenever an asterisk is found in a hex-transfer sequence, data compression is assumed. If an asterisk is encountered without a preceding count or a following hex byte pair, an error will result.

Below are examples of Delimited Hex Transfer data compression using printable characters to more readily show the data repetition. Notice that data compression can be intermixed with normal hex-transfer data.

<u>Print File Characters</u>	<u>Sent to Printer</u>
[[[[[31 32 33 34]	1234
[[[[[31 32 33 33 33 34 34 34 34]	1223334444
[[[[[31 02*32 03*33 04*34]	1223334444
[[[[[31 32 32 4*34 8*38]	122444488888888
[[[[[10 * 31]	111111111111111
[[[[[80 * 31]	1<————128————>1

### **E.3 Host Software Considerations**

The following special considerations apply when using Hex Transfer:

- Data transmitted in a hex-transfer envelope can span print buffers. This allows the transmission of long strings of transparent data.
- The hex-transfer trigger character(s) should never be the last character(s) sent from an application.
- During DSC Mode Hex Transfer, order codes NL, CR, and FF are ignored. Order code EM is honored. In addition, the printer-column counter is not updated.
- During SCS Mode Hex Transfer, all SCS control codes are ignored.
- When using hex transfer in DSC Mode printing, use unformatted print mode to achieve print format control. Unformatted versus formatted print mode is specified in the Write Control Character of all DSC Mode writes. Refer to the appropriate IBM publication.
- When Hex Transfer Mode is exited, A/C-6 (RO) resumes normal data translation.

### **E.4 SCS Mode Transparent Data**

SCS transparent mode (SCS TRN code 35) provides a method for transparent data transmission when operating in LU 1. To use this method, you must be connected to a system using SNA protocol and be operating as a Logical Unit Type 1. See **Appendix B** for more details.

An SCS TRN sequence begins with a one-byte binary count immediately following the TRN code. The count indicates the number of bytes, not including the count byte, of transparent data to follow. Up to 256 bytes of transparent data can be sent in each sequence.

SCS TRN data is user-defined and is not scanned for SCS control codes. However, to emulate the characteristics of the IBM 3287, non-printable characters (that is, control characters) are converted to hyphens. Data is translated to ASCII, with undefined characters printed as hyphens. A/C-6 (RO) offers a configurable option to emulate the IBM 3287 or to pass the data without translation. (See Option 90, SCS TRN.)

Another method of transparent data transmission is use of SCS TRN code 36, defined by XEROX. Generally accepted for use in laser printer applications, this method is the same as the A/C-6 (RO) non-translate method above. Control code sequence rules are the same for SCS code 36 as for code 35.

## **E.5 Transparent Data Transfer Options**

### **DELIMITED HEX TRANSFER STRING PREFIX**

Allows creation of a customized trigger character or string of characters to indicate that delimited hex-transfer data follows. A string of up to eight characters may be defined.

### **DELIMITED HEX TRANSFER STRING SUFFIX**

Allows creation of a customized trigger character or string of character to indicate the end of delimited hex-transfer data. Only one character can be defined.

### **FORMATTED HEX TRANSFER PREFIX**

Allows creation of a customized trigger character or string of characters to indicate that formatted hex-transfer data follows. A string of up to eight characters may be defined.

### **FORMATTED HEX TRANSFER SELECT**

Specifies whether the data following the formatted hex-transfer prefix is in Single Byte or Counted Mode.



**E.6 Pseudo-Transparency Example**

EBCDIC characters		¬	1	B	4	5	\$ (as typed in file)
EBCDIC hex values	4F	5F	F1	C2	F4	F5	5B
	↓	↓	↓	↓	↓	↓	↓
ASCII hex output to printer			1B		45		
ASCII characters output to printer			ESC				

**How It Works**

- The character representations of the desired hex values are added to the host file if using an on-screen editor. If you are using a host program, the program adds the corresponding hex value for the character to the file.
- The values to be transmitted are preceded with one or more lead-in characters to enable and followed by one exit character to exit pseudo-transparency.
- Each ASCII hex value to be output requires a byte-pair of EBCDIC.
- Lead-in and exit characters are stripped off by A/C-6 (RO) and not output to the printer.

## HOW TO DEFINE LEAD-IN AND EXIT CHARACTERS

Refer to the example above.

- For the chosen EBCDIC lead-in and exit characters, refer to the EBCDIC-to-ASCII table (SCS) or the Buffer Code-to-ASCII table (DSC) and locate the ASCII translation values. In the above example, this would be:

		EBCDIC	=	ASCII
Lead-in characters	¬	4Fh	=	CBh
		5Fh	=	CCh
Exit character	\$	5Bh	=	24h

- The example below shows what the configuration file would look like.

```
&&??%           [defines trigger character as %]
%K94,CB,CC%     [defines hex transfer trigger as | ¬]
%K95,24%       [defines hex transfer exit as $]
%K101,1%       [saves changes to preset 1]
%K102,1%       [activates preset 1, which activates new changes]
&&??<space>    [space character clears trigger character]
```

The commands are shown on a separate line for clarity, but could be combined as &&??%%K94,CB,CC%%K95,24%%K101,1%, etc.

# Appendix F: Application Programming Tips

Some printers support such advanced features as downloading and selecting soft fonts, printing raster graphics, and changing between portrait and landscape page orientation. Accessing these advanced features requires the use of escape sequences and some require the use of binary values. Because of IBM system constraints, many of the codes required cannot be sent directly from a host. This chapter presents some of the methods to assist in transmitting ASCII data through the IBM system in a form usable to the printer.

All of the configuration options referred to in this chapter can be input at a host workstation, at a serial connected PC, or on A/C-6 (RO)'s front panel.

## **F.1 IBM System Considerations**

Print data transmission through an IBM system is restricted to the EBCDIC code set defined by IBM. Host editors and print spooling programs restrict print data to the codes and usage defined by IBM. Remote telecommunication protocols also restrict code transmission. For these reasons, some of the codes needed to control the printer cannot be sent using normal methods. The escape character used in all escape commands is one of the codes that has no printable equivalent in the IBM system. Also, graphics and font download sequences are made up of binary values for which there are no printable equivalent IBM codes.

The methods described in this chapter will allow escape sequences to be sent entirely as printable IBM characters. This data will pass through host software and telecommunications paths without interference.

## **F.2 Sending Escape Sequences**

Three methods are provided by A/C-6 (RO) to facilitate the transmission of escape sequences to the printer: the user-defined initialization string, escape-character definition, and Hex Transfer.

**USER-DEFINED INITIALIZATION STRING**

A/C-6 (RO) has the capability of storing a string of ASCII data in memory using Option 61, USER INITIALIZATION STRING. This data can consist of any ASCII character, including escape sequences. String *n* is transmitted to the printer by A/C-6 (RO) whenever the printer is powered on (if so configured in Option 51, POWER-UP STRING(S), or when A/C-6 (RO) receives the Zn command, SEND PRINTER INITIALIZATION STRING. A string can be up to 254 characters in length (see Option 61, INITIALIZATION STRING, in **Appendix A**).

The initialization string can be loaded with escape sequences for the transmission of font-selection commands, page-format commands, cursor positioning, etc.

The benefit of using the initialization string is that escape sequences do not have to be sent from the host with every print job. They are sent once to the printer and remembered by A/C-6 (RO).

For example, on an HP LaserJet printer, if you wanted an alternate page format with landscape orientation and the Line Printer compressed-print default font, your Initialization String would look like this:

```
EC&11OEC(s0T
```

It would be entered into Option 61, USER INITIALIZATION STRING, as shown below.

```
&&??%.....Define % as trigger
                    character
%K61,n,1B,26,6C,31,4F,1B,28,73,30,54%.....Define Initialization
                    String n (where n=0-7)
&&??<Space> .....Clear trigger character
```

**ESCAPE-CHARACTER DEFINITION**

Since the escape character is the first character for escape sequences, this character must be available for the control of the printer's advanced features. As mentioned earlier, IBM systems do not have an equivalent control code character. However, this problem can be solved by defining an alternate character for the escape character.

As described in **Appendix D**, you can redefine any character received by A/C-6 (RO) into any other character that is sent to the printer. Thus, using this character translation it is possible to use any regular print character in place of the escape character. Naturally, it is best to select a character for the alternate escape character that is seldom or never used for printing.

This allows escape sequences to be embedded directly in print files. In this manner, commands can be intermixed with print data characters within a file.

To select an alternate character, the Printer Character Translate Table character codes must be changed. A change to this table is made using Option 75, MODIFY TABLE.

The benefit of using Option 75 is that you have immediate access to all escape sequences not requiring binary data. This allows control of the printer wherever needed with a minimum of overhead.

Once a character is defined as the escape character, it cannot be printed. If required, a character can easily be defined for escape-character use and then redefined temporarily for printing.

For example, let's say the backward slash is defined as the escape character. To change from normal to bold printing on an HP LaserJet printer, embed the character sequence `\(s3B` at the start of a print file.

The print file characters as received by the printer are shown below:

```
\(s3B .....START BOLD PRINTING
```

To change back to normal printing the following sequence should be used:

```
\(s0B .....END BOLD PRINTING
```

### NOTE

**When using this method to send escape sequences, Option 06, LINE LENGTH, must be set to 0 or escape sequences will be treated as regular data, resulting in unexpected automatic New Lines.**

### HEX TRANSFER

Another technique for sending longer escape sequences, for example those needed to print a logo or other graphics image, is transparent data transfer (see **Appendix E**).

Transparent Data-Transfer Options allow sending all escape sequences, including those requiring binary data. The escape sequences used in character-font download and raster graphics are ones that require binary data.

Escape commands that require binary data must be sent transparently through an IBM system. Several options are provided, the most useful being the Hex-Transfer Options. In Hex Transfer, data is sent in hex form using a two-byte or one-byte formula.

By using customizable characters and the availability of multiple techniques including data compression, methods are available that are compatible with most IBM emulation graphics software vendors.

Like all previous methods described, Hex Transfer allows escape sequences to be passed using printable characters. As with Option 75, MODIFY TABLE, Hex Transfer sequences can be embedded within print files and intermixed with print data.

Designed as a means of sending binary data, escape sequences can be sent using Hex Transparency. Every possible binary value can be represented in hexadecimal notation using the characters 0-9 and A-F. By converting a value to its equivalent two-character hex notation, binary data can then be transferred through an IBM system.

For example, the Hex Transfer method of selecting an italic font on an HP LaserJet printer (if one is available from either a font cartridge or a previously downloaded soft font) is shown below:

```
Escape Sequence .....E_C ( s 1 S
ASCII Hex code values .....1B 28 73 31 53

Previous line is separated .....1 B 2 8 7 3 3 1 5 3
into 10 individual characters
and sent to A/C-6 (RO)

A/C-6 (RO) combines the .....1B 28 73 31 53
characters into pairs and
transmits them to the
printer
```

For more information about the use and definition of Transparent Data Transfer Options, see Options 47, 94, 95, and 96 in **Appendix A**.

### F.3 Micro Spacing to Enable Bold Typeface

When Option 110, MICRO ADJUST, is set to Enabled, an overstrike effect will be emulated to support applications written that rely on this effect to make text boldface. This effect is performed by shifting print position for text reprinted in the same location.

#### NOTE

**This option must be disabled when using Counted or Single-Byte Hex Transfer.**

**This option only affects HP LaserJet drivers (11 and 12) and XEROX 2700 drivers (24 and 25).**

**Micro spacing is supported on these models of the HP LaserJet printer: LaserJet Plus and LaserJet series II/D, except for the original model LaserJet.**

The example below shows one method of accomplishing the overstrike effect using the Carriage Return and New Line commands.

If Option 110 is enabled and you entered the following in a print file:

```
Normal BOLD Normal <CR>
BOLD <NL>
```

The text would print as:

Normal **BOLD** Normal

With Option 110 disabled, the text would print as:

Normal BOLD Normal

The example below shows the use of the Backspace command to accomplish the same overstrike effect.

If Option 110 is enabled and you enter the following in a print file:

```
B<bs>BO<bs>OL<bs>LD<bs>D Normal<NL>
```

The text would print as:

**BOLD** Normal

With option 110 disabled, the text would print as:

BOLD Normal

## F.4 Permanent Page-Format Storage

To set up the printer for a print format that differs from the default IBM emulation page, the Printer Initialization String can be used. Option 61, USER INITIALIZATION STRING, allows you to preconfigure a group of printer escape sequences to define a print format. These escape sequences will be sent automatically each time A/C-6 (RO) is powered on to initialize the printer to your format (if so configured in Option 51, POWER-UP STRINGS).

By using presets, several page formats can be stored permanently and be activated as needed by using Option 102, ACTIVATE PRESET.

## F.5 Downloading Fonts and Raster Graphics

When fonts or graphics data streams are downloaded, much of the data appears as unstructured binary data that falls outside of defined printable IBM codes. The same is true of raster graphics data.

Transparent Data-Transfer Options provide several methods for sending raster graphics and downloading character fonts that have received wide acceptance among users of IBM emulation products. They allow sending all escape sequences, including those that require binary data.

Many graphics software vendors, including MAERSK DATA A/S, SAS, and ISSCO provide options for transferring graphics data using methods available among the Transparent Data-Transfer Options (see **Appendix E**).



# Appendix G: Printer Drivers

## **G.1 Supported Printers**

The following sections describe how each printer is supported by A/C-6 (RO).

Remember that A/C-6 (RO) and the 3X74/3276 control unit must be configured to match each other. If there is any mismatch, the host may refuse to talk to the printer or send incorrect commands for the emulated printer. Refer to the appropriate IBM publication for proper control-unit configuration.

Instructions on how to configure the printer are not exhaustive, and in most cases cover only relevant DIP switches with the rest assumed to be in default positions.

## **G.2 Printer Setup**

The printer setup section is designed to assist in interfacing the printer to A/C-6 (RO). The recommended symbol set to use in conjunction with the printer driver is listed under the heading Printer Character-Translation Table.

## **G.3 Printer Emulation**

The printer emulation section lists some of the most relevant printer-control sequences that are used by A/C-6 (RO) to implement the host SCS commands. The hex sequences sent to the printer to obtain a given effect (LPI, bold, etc.) are shown.

If a printer not covered in this appendix is to be used, the TTY driver can be used. This generic printer driver does not support special functions such as bold and underline.

**TTY (Generic Printer Driver) % K 91, 0 %**

## 1. Printer Setup

Manufacturer: Any

### *Switch Settings*

Auto LF or Auto CR should be set to OFF (disabled).

### *Printer Character-Translation Table*

Extended 7-bit ASCII Set Option 92 to 0.

### *Default Page Width*

80 columns

### *Default Print Density*

10 CPI

## 2. Printer Emulation

Most printers can be supported by this driver. This printer driver ignores every printer function, although all of them are implemented.

*Default Printer Initialization*

None

<b>Function</b>	<b>ASCII Sequence</b>	<b>Hex Sequence</b>
6 LPI	—	—
8 LPI	—	—
10 CPI	—	—
12 CPI	—	—
15 CPI	—	—
16 CPI	—	—
BEGIN BOLD	—	—
END BOLD	—	—
BEGIN UNDERLINE	—	—
END UNDERLINE	—	—
DRAFT QUALITY	—	—
NEAR LETTER QUALITY	—	—
MICRO SPACE FORWARD	—	—
MICRO SPACE BACKWARD	—	—

## 2. Printer Emulation

Most printers can be supported by this driver. This printer driver ignores every printer function, although all of them are implemented.

### *Default Printer Initialization*

None

<b>Function</b>	<b>ASCII Sequence</b>	<b>Hex Sequence</b>
6 LPI	—	—
8 LPI	—	—
10 CPI	—	—
12 CPI	—	—
15 CPI	—	—
16 CPI	—	—
BEGIN BOLD	—	—
END BOLD	—	—
BEGIN UNDERLINE	—	—
END UNDERLINE	—	—
DRAFT QUALITY	—	—
NEAR LETTER QUALITY	—	—
MICRO SPACE FORWARD	—	—
MICRO SPACE BACKWARD	—	—

**C. ITOH 300, 400, 600, 800  
Matrix Line Printers****% K 91, 2 %****1. Printer Setup**

Manufacturer:

C. ITOH

Model(s):

CI-300, CI-400, CI-600, CI-800

*Switch Settings*

All fields should be set to the default settings except for the fields listed below.

<b>Option</b>	<b>Field</b>	<b>Setting</b>	<b>Effect</b>
Initial ON/OFFLINE	29	02	Printer is online when powered on
BS Code	54	02	Backspace is enabled
Paper Instruction	64	02	Invalid (Data valid)
Buffer Clear	65	02	Disable

*Printer Character-Translation table*

Extended 7-bit ASCII                      Set Option 92 to 0.

*Line Feed and/or Backspace Emulation*

Set Option 98 to 1 (Emulate LF, do not emulate BS).

*Default Page Width*

132 columns

*Default Print Density*

10 CPI

## 2. Printer Emulation

*Default Printer Initialization*

1:1 Horizontal magnification.....	EC0<sp>.....	1B 30 20
1:1 Vertical magnification .....	EC1<sp>.....	1B 31 20
Underline Off .....	EC2<sp>.....	1B 32 20
Bold Off.....	EC3<sp>.....	1B 33 20
Plot Mode Off .....	EC7 .....	1B 37
Make ESC?xx sequences take effect temporarily .....	EC><sp>.....	1B 3E 20
Perf Line Skip=none.....	EC?+<sp>.....	1B 3F 2B 20
Underline printing .....	EC?C\$ .....	1B 3F 43 24
Standard print width=136 .....	EC?&<sp> .....	1B 3F 26 20
Compressed print width follows print width using 10 CPI .....	EC?! .....	1B 3F 27 21
Form Feed .....	(0CH) .....	0C

Function	ASCII Sequence	Hex Sequence
6 LPI .....	EC?! .....	1B 3F 21 22
8 LPI .....	EC?!# .....	1B 3F 21 23
10 CPI .....	EC?<sp>.....	1B 3F 22 20
12 CPI .....	EC?! .....	1B 3F 22 21
15 CPI .....	EC?# .....	1B 3F 22 23
16 CPI .....	EC?# .....	1B 3F 22 23
BEGIN BOLD .....	EC3! .....	1B 33 21
END BOLD .....	EC3<sp>.....	1B 33 20
BEGIN UNDERLINE .....	EC2! .....	1B 32 21
END UNDERLINE .....	EC2<sp>.....	1B 32 20
DRAFT QUALITY.....	EC?#<sp>.....	1B 3F 23 20
NEAR LETTER QUALITY .....	EC?#" .....	1B 3F 23 22
MICRO SPACE FORWARD	—	—
MICRO SPACE BACKWARD	—	—

**NOTE**

If the Vertical Line Density (LPI), Horizontal Character Density (CPI), and/or Print Quality is changed when not at the left margin, it will not take effect until the next line is printed.

These printers do not support Backspace (BS) or Carriage Return (CR) if an overstrike effect is desired.

**XEROX/DIABLO 630 Emulation    % K 91, 7 %**

1. Printer Setup

Manufacturer: Any printer model with DIABLO 630 Emulation.

*Switch Settings*

Printer-Dependent

*Printer Character-Translation Table*

Printer-dependent

*Default Page Width*

132 columns

*Default Print Density*

10 CPI

## 2. Printer Emulation

Diablo 630 Emulation is supported by this driver.

### *Default Printer Initialization*

Init .....	EC(0DH)P.....	1B 0D 50
No Auto LF.....	EC# .....	1B 23
Proportional Spacing OFF .....	ECQ .....	1B 51
Cancel Word Processing Modes .....	ECX .....	1B 58

Function	ASCII Sequence	Hex Sequence
6 LPI .....	EC(1EH)(08H) .....	1B 1E 08
8 LPI .....	EC(1EH)(06H) .....	1B 1E 06
10 CPI .....	EC(1FH)(0DH) .....	1B 1F 0D
12 CPI .....	EC(1FH)(0BH) .....	1B 1F 0B
15 CPI .....	EC(1FH)(09H) .....	1B 1F 09
16 CPI	—	—
BEGIN BOLD .....	ECO .....	1B 4F
END BOLD .....	EC@ .....	1B 40
BEGIN UNDERLINE .....	ECE .....	1B 45
END UNDERLINE .....	ECR .....	1B 52
DRAFT QUALITY	—	—
NEAR LETTER QUALITY	—	—
MICRO SPACE FORWARD	—	—
MICRO SPACE BACKWARD	—	—



**EPSON FX-80****% K 91, 8 %****1. Printer Setup**

Manufacturer EPSON

Model(s): FX-80

*Switch Settings***BANK 1**

Option	Switch	Setting	Effect
Condensed/Normal Characters .....	1-1 .....	OFF.....	Normal
Slashed Zero.....	1-2 .....	ANY	
Character Set.....	1-3 .....	ON.....	IBM PC
Printer Commands .....	1-4 .....	OFF.....	Epson Command
Print Quality.....	1-5 .....	OFF.....	Draft
Int'l Character Set .....	1-6 .....	ON.....	USA
(same) .....	1-7 .....	ON	
(same) .....	1-8 .....	ON	

**BANK 2**

Option	Switch	Setting	Effect
Page Length .....	2-1 .....	OFF.....	11 inches
Select Auto Sheet Feeder .....	2-2 .....	OFF.....	Not selected
Perforation Skip.....	2-3 .....	OFF.....	Don't Skip
Auto LF.....	2-4 .....	OFF.....	No Auto LF

*Printer Character-Translation Table*

IBM PC                      Set Option 92 to 3

*Line Feed and/or Backspace Emulation*

Set Option 98 to 1 (Emulate LF, do not emulate BS).

*Default Page Width*

80 columns

*Default Print Density*

10 CPI

## 2. Printer Emulation

The EPSON FX-80 printer is supported by this driver.

*Default Printer Initialization*

Reset .....<sup>E</sup>C@.....1B 40  
 No Perforation Skip.....<sup>E</sup>CO.....1B 4F

Function .....ASCII Sequence.....Hex Sequence

6 LPI .....<sup>E</sup>CA (12H).....1B 41 0C  
 8 LPI .....<sup>E</sup>CA (09H).....1B 41 09  
 10 CPI .....(12H) <sup>E</sup>CP<sup>E</sup>C5.....12 1B 50 1B 35  
 12 CPI .....(12H) <sup>E</sup>CM<sup>E</sup>C5.....12 1B 4D 1B 35  
 15 CPI .....—.....—  
 16 CPI .....(12H) <sup>E</sup>CP(0FH)<sup>E</sup>C5.....12 1B 50 0F 1B 35  
 BEGIN BOLD .....<sup>E</sup>CG .....1B 47  
 END BOLD .....<sup>E</sup>CH .....1B 48  
 BEGIN UNDERLINE.....<sup>E</sup>C-1 .....1B 2D 31  
 END UNDERLINE .....<sup>E</sup>C-0 .....1B 2D 30  
 DRAFT QUALITY.....<sup>E</sup>Cx0 .....1B 78 30  
 NEAR LETTER  
 QUALITY .....<sup>E</sup>Cx1 .....1B 78 31  
 MICRO SPACE FORWARD  
 MICRO SPACE BACKWARD

**HP LASERJET SERIES II****Landscape****% K 91,11 %****1. Printer Setup**

Manufacturer: Hewlett-Packard

Model(s): HP LaserJet series II/IID

*Switch Settings*

I/O=Parallel or Serial

*Printer Character-Translation Table*

ROMAN-8      Set Option 92 to 2.

*Default Page Width*

132 columns

*Default Print Density*

16 CPI

**2. Printer Emulation**

Printers supported by this printer driver include HP LaserJet, HP LaserJet+ and HP LaserJet series II. Refer to the Printer Command Table in the LaserJet Technical Reference Manual for additional information.

*Default Printer Initialization*

Reset .....	E <sub>C</sub> E .....	1B 45
Landscape .....	E <sub>C</sub> &lIO .....	1B 26 6C 31 4F
ROMAN-8 Symbol Set .....	E <sub>C</sub> (8U .....	1B 28 38 55
Pitch 16.6 CPI.....	E <sub>C</sub> (s16.6H .....	1B 28 73 31 36 2E 36 48
Style=Upright .....	E <sub>C</sub> (s0S.....	1B 28 73 30 53
Typeface=Lineprinter.....	E <sub>C</sub> (s0T .....	1B 28 73 30 54
Perf skip=ON.....	E <sub>C</sub> &lIL .....	1B 26 6C 31 4C
Copies=1 .....	E <sub>C</sub> &lIX.....	1B 26 6C 31 58
Line termination		
CR=CR, LF=LF,		
FF=FF .....	E <sub>C</sub> &k0G.....	1B 26 6B 30 47

Function	ASCII Sequence	Hex Sequence
6 LPI .....	ESC&15.3C .....	1B 26 6C 35 2E 33 43
8 LPI .....	ESC&13.97C .....	1B 26 6C 33 2E 39 37 43
10 CPI .....	ESC(s16H .....	1B 28 73 31 36 48
12 CPI .....	ESC(s16H .....	1B 28 73 31 36 48
15 CPI .....	ESC(s16H .....	1B 28 73 31 36 48
16 CPI .....	ESC(s16H .....	1B 28 73 31 36 48
BEGIN BOLD.....	ESC(s3B .....	1B 28 73 33 42
END BOLD .....	ESC(s0B .....	1B 28 73 30 42
BEGIN UNDERLINE.....	ESC&d .....	1B 26 64 44
END UNDERLINE .....	ESC&d@ .....	1B 26 64 40
DRAFT QUALITY	—	—
NEAR LETTER QUALITY	—	—
MICRO SPACE		
FORWARD .....	±ESC*p+2X.....	1B 2A 70 2B 32 58
MICRO SPACE		
BACKWARD .....	±ESC*p-2X.....	1B 2A 70 2D 32 58

## NOTE

The vertical line density has been set up so that 6 LPI will allow 66 lines per page on International A4 size paper or 68 lines per page on US letter size paper. Similarly, 8 LPI allows 88 lines on A4 size and 91 lines on letter size.

All CPI escape sequences will cause the factory default 16.6 CPI Line Printer font to be selected. This driver is intended to be used to emulate an 11" x 14" Line Printer page that accommodates 132 columns at 10 CPI. If the real 10 CPI pitch command were sent, the 10 CPI Courier font would be selected, which would restrict the line length to less than 110 columns.

## HP LASERJET SERIES II

Portrait                   % K 91,12 %

### 1. Printer Setup

Manufacturer: Hewlett-Packard

Model(s): HP LaserJet series II/IID

*Switch Settings*

I/O=Parallel or Serial

*Printer Character-Translation Table*

ROMAN-8      Set Option 92 to 2.

*Default Page Width*

80 columns

*Default Print Density*

10 CPI

**2. Printer Emulation**

Printers supported by this printer driver include HP LaserJet, HP LaserJet+, and HP LaserJet series II. Refer to the Printer Command Table in the LaserJet Technical Reference Manual for additional information.

*Default Printer Initialization*

Reset .....	EC	1B 45
Portrait.....	EC&10O.....	1B 26 6C 30 4F
ROMAN-8 symbol set.....	EC(8U .....	1B 28 38 55
Style=Upright .....	EC(s0S.....	1B 28 73 30 53
Typeface=Courier .....	EC(s3T .....	1B 28 73 33 54
Perf skip=ON.....	EC&11L.....	1B 26 6C 31 4C
Copies=1 .....	EC&11X.....	1B 26 6C 31 58
Line termination		
CR=CR,LF=LF,		
FF=FF .....	EC&kg.....	1B 26 6B 6 7

Function	ASCII Sequence	Hex Sequence
6 LPI .....	EC&17.3C .....	1B 26 6C 37 2E 33 43
8 LPI .....	EC*15.4545C .....	1B 26 6C 35 2E 34 35 34 35 43
10 CPI .....	EC(s10H .....	1B 28 73 31 30 48
12 CPI .....	EC(s12H .....	1B 28 73 31 32 48
15 CPI .....	EC(s15H .....	1B 28 73 31 35 48
16 CPI .....	EC(s16H .....	1B 28 73 31 36 48

Function	ASCII Sequence	Hex Sequence
BEGIN BOLD.....	E <sub>C</sub> (s3B.....	1B 28 73 33 42
END BOLD .....	E <sub>C</sub> (s0B.....	1B 28 73 30 42
BEGIN UNDERLINE.....	E <sub>C</sub> &dD.....	1B 26 64 44
END UNDERLINE .....	E <sub>C</sub> &d@ .....	1B 26 64 40
DRAFT QUALITY	—	—
NEAR LETTER QUALITY	—	—
MICRO SPACE		
FORWARD .....	E <sub>C</sub> *p+2X.....	1B 2A 70 2B 32 58
MICRO SPACE		
BACKWARD.....	E <sub>C</sub> *p-2X.....	1B 2A 70 2D 32 58

## NOTE

The vertical line density has been set up so that 6 LPI will allow 70 lines per page on International A4-size paper and 66 lines per page on US letter-size paper. Similarly, 8 LPI allows 94 lines on A4 size and 88 lines on letter size.

The CPI sequences will be sent to select 10, 12, 15, and 16 CPI pitches, but the actual pitch will be determined by the font to which the LaserJet defaults. See the HP LaserJet Technical Reference Manual for details.

### IBM PROPRINTER      % K 91, 15 %

#### 1. Printer Setup

Manufacturer: IBM

Model(s): Proprinter

#### Switch Settings

Option	Switch	Setting	Effect
Beeper .....	1.....	ANY	
Slashed Zeros .....	2.....	ANY	
Auto LF.....	3.....	OFF .....	No Auto LF
Form Length .....	4.....	OFF .....	11 inch
Character Set.....	5.....	ON .....	Set 2
Auto CR.....	6.....	OFF .....	No Auto CR
Reserved .....	7		

*Printer Character-Translation Table*

IBM PC Set Option 92 to 3.

*Default Page Width*

80 columns

*Default Print Density*

10 CPI

**2. Printer Emulation**

The IBM Proprinter is supported by this driver.

*Default Printer Initialization*

Clear Buffer .....	(18H) .....	18
Normal Width .....	$E_{CW0}$ .....	1B 57 30
Perf Skip=OFF .....	$E_{CO}$ .....	1B 4F
No Auto LF .....	$E_{CS}$ (00H) .....	1B 35 00
End Bold .....	$E_{CF}$ .....	1B 46
End Sub/Superscript .....	$E_{CT}$ .....	1B 54
End Underline .....	$E_{C-0}$ .....	1B 2D 30

Function	ASCII Sequence	Hex Sequence
6 LPI .....	$E_{CA}$ (0CH) $E_{C2}$ .....	1B 41 09 1B 32
8 LPI .....	$E_{CA}$ (09H) $E_{C2}$ .....	1B 41 09 1B 32
10 CPI .....	(12H) .....	12
12 CPI .....	$E_C$ : .....	1B 3A
15 CPI .....	(12H) (0FH) .....	12 0F
16 CPI .....	(12H) (0FH) .....	12 0F
BEGIN BOLD .....	$E_{CE}$ .....	1B 45
END BOLD .....	$E_{CF}$ .....	1B 46
BEGIN UNDERLINE .....	$E_{C-1}$ .....	1B 2D 31
END UNDERLINE .....	$E_{C-0}$ .....	1B 2D 30
DRAFT QUALITY .....	$E_{CH}$ .....	1B 48
NEAR LETTER QUALITY .....	$E_{CG}$ .....	1B 47
MICRO SPACE FORWARD		
MICRO SPACE BACKWARD		

**XEROX 4045 (2700 Emulation—Portrait) % K 91, 24 %**

## 1. Printer Setup

Manufacturer: XEROX

Model(s): 4045

*Switch Settings*

## BANK A

Option	Switch	Setting	Effect
Interface .....	1 .....	OFF .....	Parallel
(same).....	(same) .....	ON.....	Serial
Printer Mode.....	2 .....	OFF .....	2700 Mode
Line Ending Decisions ....	3 .....	OFF .....	No Auto CR, No Auto LF
(same).....	4 .....	OFF	
Character Size .....	5 .....	ON.....	8-bit data
Data Encoding .....	6 .....	ON.....	IBM PC
(same).....	7 .....	ON	
Custom Cartridge .....	8 .....	OFF .....	No Custom Cartridge Table

## BANK B

Option	Switch	Setting	Effect
Language.....	1 .....	ON.....	American English
(same).....	2 .....	ON	
(same).....	3 .....	ON	
(same).....	4 .....	ON	
Status Sheet 5 .....	ON .....		Status Sheet to be Printed
Chime .....	6 .....	OFF .....	No Bell
Default Font .....	7 .....	OFF .....	Resident Portrait
(same).....	8 .....	OFF	



**BANK C**

Option	Switch	Setting	Effect
XON/XOFF .....	1 .....	ON.....	XON/XOFF used
ETX/ACK.....	2 .....	OFF .....	ETX/ACK not used
Print Ready.....	3 .....	ON.....	DTR ready signal
Baud Rate .....	4 .....	ON.....	9600 baud
(same).....	5 .....	ON.....	(same)
(same).....	6 .....	OFF .....	(same)
Unassigned.....	7 .....	ANY	
Unassigned.....	8 .....	ANY	

**BANK D**

Option	Switch	Setting	Effect
Parallel Interface.....	1 .....	OFF .....	Centronics
Inverted Data (Parallel) ..	2 .....	OFF .....	Not used
Parity (Serial) .....	(same) .....	OFF .....	Parity not used
VFU Emulation .....	3 .....	OFF .....	Not used
(same).....	4 .....	ANY	
Character Spacing.....	5 .....	OFF .....	10 CPI
(same).....	6 .....	ON	
Horizontal Tabs .....	7 .....	ANY	

*Printer Character-Translation Table*

IBM PC Set Option 92 to 3.

*Line Feed and/or Backspace Emulation*

Set Option 98 to 2 (Emulate BS, do not emulate LF).

*Default Page Width*

80 columns

*Default Print Density*

10 CPI

## 2. Printer Emulation

The XEROX 4045 printer is supported by this driver.

### *Default Printer Initialization*

```

Reset .....EC+XCRLF.....1B 2B 58 0D 0A
Set Page Format to 66
Lines and 80 columns.....ECm660,0,0,15,495CRLF.....1B 6D 36 36 30 2C
                                                    30 2C 30 2C 31 35
                                                    2C 34 39 35 0D 0A

Justification Off.....ECk .....1B 6B
Merge Stop.....ECzd .....1B 7A 64
Overstrike Stop .....ECzp .....1B 7A 70
Vertical Tab Clear.....ECe .....1B 65
CR to Left Margin.....CR.....0D
Assign Portrait Font to
Font ID #1 .....EC+1Titan10iso-PCRLF .....1B 2B 31 54 69 74
                                                    61 6E 31 30 69 73 6F
                                                    2D 50 0D 0A

Select Font #1.....EC1 .....1B 31

```

Function	ASCII Sequence	Hex Sequence
6 LPI	—	—
8 LPI	—	—
10 CPI	—	—
12 CPI	—	—
15 CPI	—	—
16 CPI	—	—
BEGIN BOLD.....	E <sub>Cb</sub> .....	1B 62
END BOLD .....	E <sub>Cp</sub> .....	1B 70
BEGIN UNDERLINE.....	E <sub>Cu</sub> .....	1B 75
END UNDERLINE .....	E <sub>Cw</sub> .....	1B 77
DRAFT QUALITY	—	—
NEAR LETTER	—	—
QUALITY	—	—
MICRO SPACE	—	—
FORWARD .....	E <sub>Crr</sub> 2<sp>.....	1B 72 72 32 20
MICRO SPACE	—	—
BACKWARD.....	E <sub>Cr</sub> l2<sp>.....	1B 72 6C 32 30

**XEROX 4045 (2700 Emulation—Landscape) % K 91, 25 %**

## 1. Printer Setup

Manufacturer: XEROX

Model(s): 4045

*Switch Settings*

## BANK A

Option	Switch	Setting	Effect
Interface .....	1 .....	OFF .....	Parallel
(same).....	(same) .....	ON.....	Serial
Printer Mode .....	2 .....	OFF .....	2700 Mode
Line Ending			
Decisions .....	3 .....	OFF .....	No Auto CR, No Auto LF
(same)	4	OFF	
Character Size	5	ON	8-bit Data
Data Encoding	6	ON	IBM PC
(same)	7	ON	
Custom Cartridge	8	OFF	No Custom Cartridge Table

## BANK B

Option	Switch	Setting	Effect
Language .....	1 .....	ON.....	U.S. English
(same).....	2 .....	ON	
(same).....	3 .....	ON	
(same).....	4 .....	ON	
Status Sheet .....	5 .....	ON.....	Status Sheet to be Printed
Chime .....	6 .....	OFF .....	No Bell
Default Font .....	7 .....	OFF .....	Resident Landscape
(same).....	8 .....	ON	

## BANK C

Option	Switch	Setting	Effect
XON/XOFF .....	1 .....	ON .....	XON/XOFF used
ETX/ACK .....	2 .....	OFF .....	ETX/ACK not used
Print Ready .....	3 .....	ON .....	DTR ready signal
Baud Rate .....	4 .....	ON .....	9600 baud
(same) .....	5 .....	ON .....	(same)
(same) .....	6 .....	OFF .....	(same)
Unassigned .....	7 .....	ANY	
Unassigned .....	8 .....	ANY	

**BANK D**

Option	Switch	Setting	Effect
Parallel Interface .....	1 .....	OFF .....	Centronics
Inverted Data (Parallel) .....	2 .....	OFF .....	Not used
Parity (Serial) .....	(same) .....	OFF .....	Parity not used
VFU Emulation .....	3 .....	OFF .....	Not used
(same) .....	4 .....	ANY	
Character Spacing .....	5 .....	OFF .....	10 CPI
(same) .....	6 .....	ON	
Horizontal Tabs .....	7 .....	ANY	

*Printer Character-Translation Table*

IBM PC Set Option 92 to 3.

*Line Feed and/or Backspace Emulation*

Set Option 98 to 2 (Emulate BS, do not emulate LF).

*Default Page Width*

132 columns

*Default Print Density*

16 CPI

**2. Printer Emulation**

The XEROX 4045 printer is supported by this driver.

*Default Printer Initialization*

```

Reset .....EC+XCRLF.....1B 2B 59 0D 0A
Justification Off.....ECk .....1B 6B
Merge Stop.....ECzd .....1B 7A 64
Overstrike Stop .....ECzp .....1B 7A 70
Vertical Tab Clear.....ECe .....1B 65
CR to Left Margin.....CR.....0D
Assign Landscape
Font to Font ID #1 .....EC+1XCP14iso-LCRLF1B 2B 31 58 43 50
                                     31 34 69 73 6F 2D
                                     4C 0D 0A
Select Font #1.....EC1 .....1B 31

```

Function	ASCII Sequence	Hex Sequence
6 LPI	—	—
8 LPI	—	—
10 CPI	—	—
12 CPI	—	—
15 CPI	—	—
16 CPI	—	—
BEGIN BOLD.....	E <sub>C</sub> b .....	1B 62
END BOLD .....	E <sub>C</sub> p .....	1B 70
BEGIN UNDERLINE.....	E <sub>C</sub> u .....	1B 75
END UNDERLINE .....	E <sub>C</sub> w .....	1B 77
DRAFT QUALITY	—	—
NEAR LETTER	—	—
QUALITY	—	—
MICRO SPACE	—	—
FORWARD .....	E <sub>C</sub> rr2<sp>.....	1B 72 72 32 20
MICRO SPACE	—	—
BACKWARD.....	E <sub>C</sub> rl2<sp>.....	1B 72 6C 32 20

**OTC 2100 Series % K 91, 26 %**

## 1. Printer Setup

Manufacturer: Output Technology Corp.

Model(s): OTC 2100 Series Printers

*Switch Settings*

Set to defaults except as shown below:

Option	Setting
Character Set.....	IBM 1
Host Interface .....	Parallel

*Printer Character-Translation Table*

IBM PC Set Option 92 to 3.

*Line Feed and/or Backspace Emulation*

Set Option 98 to 1 (Emulate LF, do not emulate BS).

*Default Page Width*

132 columns

*Default Print Density*

10 CPI

**2. Printer Emulation**

The OTC 2100 Series printers are supported by this driver.

*Default Printer Initialization*

```

Reset .....EC@ .....1B 40
No Perforation Skip.....ECO .....1B 4F
Select IBM PC
Character Set #2.....(01H) AzF (02H) .....01 41 7A 46 02
Select Code
Page 850 .....(01H) AzI (01H) .....01 41 7A 49 01

```

Function	ASCII Sequence	Hex Sequence
6 LPI .....	E <sub>CA</sub> (12H).....	1B 41 12
8 LPI .....	E <sub>CA</sub> (09H).....	1B 41 09
10 CPI.....	(01H) Az! (00H) .....	01 41 7A 21 00
12 CPI.....	(01H) Az! (01H) .....	01 41 7A 21 01
15 CPI.....	(01H) Az! (02H) .....	01 41 7A 21 02
16 CPI.....	(01H) Az! (04H) .....	01 41 7A 21 04
BEGIN BOLD.....	E <sub>CG</sub> .....	1B 47
END BOLD .....	E <sub>CH</sub> .....	1B 48
BEGIN UNDERLINE.....	E <sub>C-1</sub> .....	1B 2D 31
END UNDERLINE .....	E <sub>C-0</sub> .....	1B 2D 30
DRAFT QUALITY.....	E <sub>Cx0</sub> .....	1B 78 30
NEAR LETTER QUALITY .....	E <sub>Cx1</sub> .....	1B 78 31
MICRO SPACE FORWARD	—	—
MICRO SPACE BACKWARD	—	—

# Appendix H: Diagnostic Dump

Diagnostic Dump is a configuration option that allows the printout of application data in its hexadecimal form as received from the IBM Control Unit. It is commonly used in situations where a host application does not print as intended.

## H.1 DSC Mode Diagnostic Dump

In the following example, all codes in the range of 40H to FEH were sent to a 3274-61C using the English (US) language set. Lines 0000-0040 display the Printer Control Information Area, and are generally not significant. However, on line 0010, locations 4 and 5 give the length of the data stream. Line 0050 always begins the application data dump in DSC mode. And in this case, the dump would go on until location 07D0 (0050 + 0780). Each page is numbered and dump lines in the data area are suppressed if they are identical to the previous line printed.



Page 001

**PRINTER CONTROL INFORMATION AREA**

```
ADDR 0 1 2 3 4 5 6 7 8 9 A B C D E F 0 1 2 3 4 5 6 7 8 9 A B C D E F
0000 00 00 5D 00 00 00 00 00 00 00 00 15 10 00 00.....\...
0010 00 05 00 50 07 80 03 00 00 00 00 00 00 00 00..... a.....
0020 00 00 00 00 00 00 00 00 00 00 00 00 00 00 00.....
0030 00 00 00 00 00 00 00 00 00 00 00 00 00 00 00.....
0040 00 00 00 00 00 00 00 00 00 00 00 AA32 74 AA00 00..... K.. K..
```

**PRINTER DATA AREA**

```
ADDR 0 1 2 3 4 5 6 7 8 9 A B C D E F 0 1 2 3 4 5 6 7 8 9 A B C D E F
0050 10 0A0B 1C 1D 1E 1F 2A 2B 37 1B 32 09 0D 35 16. [ ] ..... [ . < ( + |
0060 30 38 39 3A 3C 3E 3F 40 41 42 19 1A BF 0C BE 36 &.. ^..... ! $ * ) ; ^
0070 31 14 43 44 45 46 47 48 49 4A 17 33 2E 2F 08 18 - / ..... | , % - > ?
0080 4B 4C 4D 4E 4F 50 51 52 53 3D 34 2C 2D 12 11 13 ..... : # @ ' = *
0090 54 80 81 82 83 84 85 86 87 88 55 56 57 58 59 5A. a b c d e f g h i .....
00A0 5B 89 8A 8B 8C 8D 8E 8F 90 91 5C 5D 5E 5F 60 61. j k l m n o p q r .....
00B0 62 3B 92 93 94 95 96 97 98 99 63 64 65 66 67 68. - s t u v w x y z .....
00C0 69 6A 6B 6C 6D 6E 6F 70 71 72 73 74 75 76 77 78. ....
00D0 0F A0A1 A2 A3 A4A5 A6 A7 A8 79 7A 7B 7C 31 31 { A B C D E F G H I. ....-
00E0 0E A9 AA AB AC AD AE AF B0 B1 7D 7E 7F 31 31 31 } J K L M N O P Q E. ....-
00F0 15 9A B2 B3 B4 B5 B6 B7 B8 B9 9B 9C 9D 31 31 31 \. S T U V W X Y Z. ....-
0100 20 21 22 23 24 25 26 27 28 29 BA BB BC BD 31 00 0 1 2 3 4 5 6 7 8 9 .....
0110 00 00 00 00 00 00 00 00 00 00 00 00 00 00 00 .....
*** Same Data As Line Above
```

**Figure H-1 Diagnostic Dump.**

## H.2 SCS (LU1) Mode Diagnostic Dump

In the following example, all codes in the range of 00H to FFH were sent to a 3274-61C using the English (US) language set. Lines 0000-0040 display the Printer Control Information Area, and are generally not significant. However, on line 0010, locations 2 and 3 give the data starting location relative to 0000, and locations 4 and 5 give the length of the data stream. In this case, line 0067 (0000 + 0067) begins the dump of application data, and line 0167 (0067 + 0100) shows buffer memory beyond the data being dumped. Each page is numbered and dump lines in the data area are suppressed if they are identical to the previous line printed.

Page 001

### PRINTER CONTROL INFORMATION AREA

```
ADDR 0 1 2 3 4 5 6 7 8 9 A B C D E F 0 1 2 3 4 5 6 7 8 9 A B C D E F
0000 00 04 5D 00 00 00 00 00 00 00 00 15 10 00 00 . - ) . . . . .
0010 04 06 00 67 01 00 03 64 00 00 00 00 00 00 00 00 - - - - -
0020 00 00 00 00 00 00 00 00 00 00 00 00 00 00 00 00 . . . . .
0030 00 00 00 00 00 00 00 00 00 00 00 00 00 00 00 00 . . . . .
0040 00 00 00 00 00 00 00 00 00 00 00 AA32 74 AA00 00 . . . . .
```

### PRINTER DATA AREA

```
ADDR 0 1 2 3 4 5 6 7 8 9 A B C D E F 0 1 2 3 4 5 6 7 8 9 A B C D E F
0067 00 01 02 03 04 05 06 07 08 09 0A0B 0C 0D 0E 0F . - - - - -
0077 10 11 12 12 14 15 16 17 18 19 1A 1B 1C 1D 1E 1F - - - - -
0087 20 21 22 23 24 25 26 27 28 29 2A 2B 2C 2D 2E 2F - - - - -
0097 30 31 32 33 34 35 36 37 38 39 3A 3B 3C 3D 3E 3F - - - - -
00A7 40 41 42 43 44 45 46 47 48 49 4A 4B 4C 4D 4E 4F . - - - - - [ . < ( + |
00B7 50 51 52 53 54 55 56 57 58 59 5A 5B 5C 5D 5E 5F & - - - - - ! $ * ) ; ^
00C7 60 62 62 63 64 65 66 67 68 69 6A 6B 6C 6D 63 6F - / - - - - - | , % _ > ?
00D7 70 71 72 73 74 75 76 77 78 79 7A 7B 7C 7D 7E 7F - - - - - : # @ ' = "
00E7 80 81 82 83 84 85 86 88 88 89 8A 8B 8C 8D 8E 8F - a b c d e f g h i - - - - -
00F7 90 91 92 93 94 95 96 97 98 99 9A 9B 9C 9D 9E 9F - j k l m n o p q r - - - - -
0107 A0 A1 A2 A3 A4 A5 A6 A7 A8 A9 AAAB AC ADAE AF - _ s t u v w x y z - - - - -
0117 B0 B1 B2 B3 B4 B5 B6 B7 B8 B9 BA BB BC BDBEBF - - - - -
0127 C0 C1 C2 C3 C4 C5 C6 C7 C8 C9 CA CB CC CDCECF { A B C DEFGHI - - - - -
0137 D0 D1 D2 D3 D4 D5 D6 D7 D8 D9 DA DB DC DDDDEF } J K L MNOPQR - - - - -
0147 E0 E1 E2 E3 E4 E5 E6 E7 E8 E9 EAEB EC ED EE EF \ - S T U V WXYZ - - - - -
0157 F0 F1 F2 F3 F4 F5 F6 F7 F8 F9 FA FB FC FD FE FF 0 1 2 3 4 5 6 7 8 9 - - - - -
0167 00 00 00 00 00 00 00 00 00 00 00 00 00 00 00 . . . . .
```

Figure H-2. SCS (LU1) Mode Diagnostic Dump.

# Appendix I: Interface Specifications

A/C-6 (RO) provides both a DB25 serial interface and a DB25 Centronics parallel interface.

## 1.1 Asynchronous Serial Communication

If you are connecting A/C-6 (RO) to a serial printer/output device, it will be transferring data asynchronously. If you are unfamiliar with asynchronous serial communication techniques, the following information may be of help to you. Some fundamental data-communications terms are defined as they relate to how A/C-6 (RO) will communicate with your printout device.

### FLOW-CONTROL SIGNALING

Flow control signaling is a way to pace the data transfer between devices of different speeds. More than just data-transfer speed is of concern when transferring data to a mechanical device such as a printer, because paper movement and other mechanical activity take time, during which the device may be unable to accept data.

Flow control signaling is used to interrupt data transfer temporarily for conditions that will automatically clear. Lost data is the most common symptom of incorrect configuration of flow control signaling.

A/C-6 (RO) supports XON/XOFF and Busy signaling for printer flow control.

When the printer is no longer able to accept incoming data, it sends an XOFF code (13H) to A/C-6 (RO) or drops its Busy signal. A/C-6 (RO) stops output data transfer immediately. A/C-6 (RO) then waits until an XON (11H) is received or the printer's Busy signal is raised before sending additional data.

For a serial interface, A/C-6 (RO) can be configured to recognize the Busy signal on Pin 11 or Pin 20/6 (Pin 20 if A/C-6 (RO) is set for DCE and Pin 6 if A/C-6 (RO) is set for DTE). When the Busy signal pin is HIGH it indicates NOT BUSY, and when it is LOW it indicates BUSY. The NONE option is used if your printer has no means of signaling Busy. Be aware that if the NONE option is chosen and your printer goes BUSY, lost data will result.

In DCE mode:	Pin 11	HIGH=Not Busy LOW=Busy
	Pin 20 (DTR)	HIGH=Not Busy LOW=Busy
In DTE mode:	Pin 11	HIGH=Not Busy LOW=Busy
	Pin 6 (DSR)	HIGH=Not Busy LOW=Busy

XON/XOFF is a method of indicating Busy that uses characters transmitted from the receiving device back to the transmitting device. XON/XOFF is always supported by A/C-6 (RO), and is not configured.

#### **READY SIGNALING**

Ready signaling is used to indicate the current permanent ability or inability of a device to accept data transfer. It generally reflects operator controllable device conditions. Not Ready is signaled when the printer is taken off-line, runs out of paper, or has some other fault that requires operator intervention. When a device is Not Ready, it cannot accept data transfer.

When the printer goes Not Ready, it drops its Ready signal. A/C-6 (RO) stops data transfer immediately, and then begins a series of timed notification actions noted below. When the Ready signal is raised by the printer, A/C-6 (RO) resets itself and may resume data transfer.

For a serial interface, A/C-6 (RO) can be configured to recognize the Ready signal on Pin 4 or 5 (DCE or DTE interface) or Pin 20 or 6 (DCE or DTE). When the Ready signal pin is HIGH it indicates READY, and when it is LOW it indicates NOT READY. The NONE option is used if your printer provides no means of Ready signaling. Be aware that if the NONE option is chosen and your printer goes NOT READY, lost data will result.

## A/C-6 (RO)

In DCE mode:	Pin 4 (RTS)	HIGH=Ready LOW=Not Ready
	Pin 20 (DTR)	HIGH=Ready LOW=Not Ready
In DTE mode:	Pin 5 (CTS)	HIGH=Ready LOW=Not Ready
	Pin 6 (DSR)	HIGH=Ready LOW=Not Ready

If a Not Ready condition is detected, the READY indicator goes off, and ERROR 01 is displayed. A/C-6 (RO) then initiates a configurable error delay timeout. What happens next is determined by the settings of two configuration options. The following description is written assuming that options PRINTER ERROR TIMEOUT and AUTO-HOLD PRINT are set to their defaults (PRINTER ERROR TIMEOUT=EMULATE 3287 and AUTO-HOLD PRINT=NONE).

Upon detection of the Not Ready condition, A/C-6 (RO) allows one minute for the operator to either fix the printer, or press the Hold Print button, before an Intervention Required is sent to the host. ERROR 31 is displayed. If Hold Print is pressed within the first minute, however, more time (10 minutes) is allowed before Intervention Required is sent. If 10 minutes elapses and the printer is still Not Ready, ERROR 08 is displayed. In all cases, A/C-6 (RO) will only send Intervention Required to the host when a print operation is taking place, and if PRINTER ERROR PRESENTATION is configured to EMULATE the IBM 3287.

### DCE/DTE

All serial interface equipment can be classified as either Data Communications Equipment (DCE) or Data Terminal Equipment (DTE).

Modems (used in a pair with a phone-line connection) and line drivers are examples of DCE. Most terminals and output devices (such as serial printers) are classified as DTE.

Two devices of the same type should not be connected to each other.

Consult your printer user's manual to see if your device is sending signals as a DCE or DTE. If the operating manual does not identify your device as either, chances are it is set up as a DTE. Most serial printers are classified as DTE.

#### **BAUD RATE, BITS PER CHARACTER AND PARITY**

A/C-6 (RO) supports a number of different baud rates (serial transfer rates), character bit lengths, and parity options to allow use of virtually any serial output device.

The baud rate controls the speed at which the data is sent to the printer. This should be set to the maximum baud rate that the printer will accept.

Character bit length and parity control the format used for transmission of the data. Data may be sent using either 7 or 8 data bits plus a parity bit (even, odd, or none). Normally for standard ASCII character printing, 7 bits are sufficient, but for printing languages other than U.S. English or transparent data, the full 8 bits may be required. Parity is used to provide warning if data transmission is corrupted between A/C-6 (RO) and the printer.

These options must all be set to agree with the options used by the printer.

## **I.2 Coax Input/Output**

A/C-6 (RO) includes a BNC coaxial receptacle on its back panel. It interfaces with standard IBM 3270-type coaxial cables and meets all hardware requirements specified in the IBM document *IBM 3174/3274 Control Unit to Device Product Attachment Information*.

A/C-6 (RO) also provides an RJ-45 telephone-type connector with an internal balun for connecting to the host over standard balanced twisted-pair wire.

### **I.3 Serial Interface**

A/C-6 (RO) includes an async RS-232C port permanently wired in DCE configuration. It supports transfer rates from 300 through 38,400 baud.

The serial port interface connector is a shielded DB25S connector. It is designed to be used with a shielded DB25P connector. An appropriate cable to an asynchronous serial DTE printer with a DB25S connector will have straight-through connections to all the pins listed below.

Serial port signals fully meet the requirements of RS-232C. Signals are received by inputs on an 14C89 device (TD, RTS, Pin 11, DTR). Signals are driven by outputs on the 14C88 (RD, CTS, DSR, DCD).

Table I-1. Serial Interface Pinouts.

<b>Pin #</b>	<b>Signal</b>	<b>Direction</b>
1	NC	(No Connection)
2	TD	INPUT
3	RD	OUTPUT
4	RTS	INPUT
5	CTS	OUTPUT
6	DSR	OUTPUT
7	GND	
8	DCD	OUTPUT
9	NC	
10	NC	
11	BUSY	INPUT
12 through 19	NC	
20	DTR	INPUT
21 through 25	NC	



## **I.4 Parallel Interface**

This is a standard IBM PC parallel printer interface (Centronics configuration). A/C-6 (RO) supports the Centronics interface signals Busy, Ack(nowledge), Select, Fault, Data 0 through 7, Strobe, and Autofxt. The parallel port is located on the back of A/C-6 (RO) and is labeled PARALLEL.

Having selected the parallel interface, printer Busy, Not Ready, and Fault detection are configured by default. If A/C-6 (RO) detects a signal drop on either Pin 13 or Pin 32, it assumes that the printer is not ready.

If a Not Ready condition is detected, the front-panel READY indicator goes out, and ERROR 01 is displayed. A/C-6 (RO) allows one minute for you to either fix the printer, or press the Hold Print button, before an Intervention Required is sent to the host. ERROR 31 is displayed. If Hold Print is pressed within the first minute, however, more time (10 minutes) is allowed before Intervention Required is sent. If 10 minutes elapse and the printer is still Not Ready, ERROR 08 is displayed. In all cases, A/C-6 (RO) will only send Intervention Required to the host when a print operation is taking place, and if PRINTER ERROR PRESENTATION is configured to EMULATE the IBM 3287.

**Table I-2. Serial Interface Pinouts.**

<b>Pin #</b>	<b>Signal</b>
1	STROBE
2	DATA 0
3	DATA 1
4	DATA 2
5	DATA 3
6	DATA 4

Table I-2. Serial Interface Pinouts.

<b>Pin #</b>	<b>Signal</b>
7	DATA 5
8	DATA 6
9	DATA 7
10	ACK
11	BUSY
12	PE
13	SELECT
14	AUTOEXT
15	ERROR
16	INIT
17	SLCT IN
18 through 25	GND

## Appendix J: Quick Reference

In this appendix the A/C-6 (RO) configuration commands are summarized for quick reference. The configuration option commands are listed in numerical order in **Table J-2**.

**Table J-1 Function/Commands.**

<b>Function</b>	<b>Command</b>
Define Configuration Trigger	%%??%
Clear Configuration Trigger	&&??<Space>
Change Configuration Option	%KNN, value %
Make Changes Permanent	%X1
Recall Default Options	%X3
Recall Permanent Options	%X4
Send Printer Initialization String	%Zn
Print Preset	%Vn

### **NOTE**

% represents the defined trigger character.

<Space> represents a space character to immediately follow the second ? character in the example above.

Table J-2. Configuration Option Commands.

Option	K Command	Value	Description
Logical Buffer Size	01	2	1920 characters
		3	2560 characters
		4*	3440 characters
		5	3564 characters
Lines Per Inch (Vertical Density)	02	3	Lines per inch
		4	
		6*	
		8	
Characters Per Inch (Horizontal Density)	03	10*	Characters per inch
		12	
		15	
		16	
Form Length (Page Length)	05	66* 0-127	Lines per page
Line Length (Page Width)	06	80* 0-255	Characters per line
Case	07	Mono Case	Upper case only
		Dual Case*	Upper and lower case
LU1 Language	08	English (US) EBCDIC Other Languages	
Print Quality	09	Draft* Letter Quality	

\*Default.

**Table J-2. Configuration Option Commands.**

<b>Option</b>	<b>K Command</b>	<b>Value</b>	<b>Description</b>
Printer Port	14	1	Serial
		2*	Parallel
Baud	15	38400	
		19200	
		9600*	
		4800	
		2400	
		1200	
		600	
		300	
		110	
75			
Data Bits	16	7 Bits	Bits per character
		8 Bits*	Bits per character
Parity	17	None*	No parity
		Even	Even parity
		Odd	Odd parity
Stop Bits	18	1*	1 stop bit
		2	2 stop bits

**\*Default.**

Table J-2. Configuration Option Commands.

Option	K Command	Value	Description
Device Flow Control	19	None XON/XOFF* DTR RTS Pin 11 low Pin 11 high	
Converter Flow Control	20	None XON/XOFF CTS* DSR	
Device Ready	21	None* DTR RTS Pin 11 low Pin 11 high	
Passthrough	22	Disabled* Enabled	
Serial Timeout	23	1-255 3*	Timeout in 5-sec intervals Timeout in 15 seconds
Host Timeout	24	1-255	Timeout in 5-sec intervals

\*Default.

**Table J-2. Configuration Option Commands.**

<b>Option</b>	<b>K Command</b>	<b>Value</b>	<b>Description</b>
Form Feed Before Local Copy	25	No* Yes	No FF before local copy FF before local copy
Form Feed After Local Copy	26	No* Yes	No FF after local copy FF after local copy
Suppress Null Lines	27	No Yes*	Emulate 3287 Print true image
CR At MPP +1	28	Auto NL* No Auto	Send NL Suppress NL
NL At MPP +1	29	Auto NL* No Auto NL	Send NL Suppress NL
Space After Form Feed?	30	Yes* No	Generate space Suppress space
FF at End of Buffer	31	Do NL* Suppress NL	Send NL after FF Suppress NL after FF
Form Feed Valid	32	Emulate 3287* Anywhere	Execute FF at first position only Execute FF at any location
Form-Feed Emulation	35	Use FF* Use LFs	Send FF Send LFs

**\*Default.**

Table J-2. Configuration Option Commands.

Option	K Command	Value	Description
Vertical Channel Select Support	37	No*	VCS not supported
		Yes	VCS supported
Print Empty Form	39	Yes*	Send empty forms
		No	Suppress empty forms
Intervention Required Delay	46	0-255	Timeout in 5 sec intervals
		12*	Send IR after 1 minute
Formatted Hex Transfer	47	Single Byte* Counted	
Power-up Strings	51	1* Specify User String 0-7	Send String 1
Create Table	71	1*	Create Translate Table 1 —through—
		8	Create Translate Table 8
Delete Table	72	2	Delete Translate Table 2 —through—
		8	Delete Translate Table 8
Select Table	73	1	Select Translate Table 1 —through—
		8	Select Translate Table 8

\*Default.



**Table J-2. Configuration Option Commands.**

<b>Option</b>	<b>K Command</b>	<b>Value</b>	<b>Description</b>
Modify Table	75	No default	
EM Action	89	Nothing New Line* Form Feed	
SCS Transparency	90	Emulate 3287* Transparent	
Printer Emulation	91	TTY (Generic Driver)* C. ITOH 300, 400, 600, 800 XEROX/DIABLO 630 EPSON FX-80 HP LaserJet—Landscape HP LaserJet—Portrait IBM Proprinter XEROX 4045—Portrait XEROX 4045—Landscape OTC 2100 Series	
Apply To Table	92	ISO* ROMAN-8 IBM PC ASCII 7-bit	
Delimited Hex Transfer Prefix	94	No default	

**\*Default.**

Table J-2. Configuration Option Commands.

Option	K Command	Value	Description
Delimited Pseudo Suffix	95	No default	
Formatted Pseudo Prefix	96	No default	
Report Errors	97	Yes* No	Report errors Do not report errors
Emulate Line Feed	98	No* Yes	Do not emulate Emulate
Emulate Backspace	98	No* Yes	Do not emulate Emulate
Power-on Preset	99	1*  8	Define power-up Preset 1 — <i>through</i> — Define power-up Preset 8
Get Preset	100	Active 1-8	Get Preset 1 — <i>through</i> — Get Preset 8
Save Preset	101	1* Active 1-8	Save Preset 1 — <i>through</i> — Save Preset 8

\*Default.

**Table J-2. Configuration Option Commands.**

<b>Option</b>	<b>K Command</b>	<b>Value</b>	<b>Description</b>
Print User Table	103	1	Print Translate Table 1 — <i>through</i> —
		8	Print Translate Table 8
Print User String	104	0	Print User String 0 — <i>through</i> —
		7	Print User String 7
Micro Adjust	110	Disabled*	Overstrike disabled
		Enabled	Overstrike enabled
New Line Sequence	111	CR/LF*	
		LF/CR	
		None	
		CR	
		LF	
Count Pseudo Columns	112	No*	
		Yes	
Translate Nulls	113	0*	As spaces
		1	As nulls
Eject Last Page	114	1-255	Timeout in 5-sec intervals
		0*	Never time out

**\*Default.**

Table J-2. Configuration Option Commands.

Option	K Command	Value	Description
Commands 120 to 133 allow you to customize a printer driver according to horizontal print density, vertical print density, bold print, underline print, print quality, and micro-spacing.			
10 CPI	120	% K 120, user-defined string # %	
12 CPI	121	% K 121, user-defined string # %	
15 CPI	122	% K 122, user-defined string # %	
16 CPI	123	% K 123, user-defined string # %	
6 LPI	124	% K 124, user-defined string # %	
8 LPI	125	% K 125, user-defined string # %	
Begin Underline	126	% K 126, user-defined string # %	
End Underline	127	% K 127, user-defined string # %	
Begin Bold	128	% K 128, user-defined string # %	
End Bold	129	% K 129, user-defined string # %	
LQ String	130	% K 130, user-defined string # %	
Draft String	131	% K 131, user-defined string # %	
Micro Forward Space	132	% K 132, user-defined string # %	
Micro Backward Space	133	% K 133, user-defined string # %	

# Appendix K: Troubleshooting

## K.1 Troubleshooting

If A/C-6 (RO) does not appear to operate properly, the following table may identify and help locate the source of the problem.

**Table K-1. Troubleshooting Chart.**

<b>Problem</b>	<b>Probable Cause and Suggested Action</b>
No Indicators On	<p>Power Problem</p> <p>Turn A/C-6 (RO) off, unplug the power cord from its outlet and test the outlet by plugging in something else; a light, for example.</p> <p>If power is present at the outlet, reconnect A/C-6 (RO) and proceed. Otherwise, have the power problem corrected.</p> <p>Turn A/C-6 (RO) on. If the indicators remain off, A/C-6 (RO) is at fault.</p> <p>Check the fuse at the back panel of the A/C-6 (RO). If the fault continues, call for technical support.</p>

Table K-1. Troubleshooting Chart.

<b>Problem</b>	<b>Probable Cause and Suggested Action</b>
Will Not Print	<p data-bbox="391 305 657 329">Printer Interface Problem</p> <p data-bbox="391 375 953 435">Make sure that A/C-6 (RO) is configured properly for the connected printer.</p> <p data-bbox="391 483 953 651">For serial printers: Configure the Ready and Busy options as directed in the printer's user's guide, as well as the baud rate, Parity, and Bits Per Character. If the printer still does not print, connect an async terminal in place of the printer and retest.</p> <p data-bbox="391 699 966 792">For all printers: Make sure that the printer is switched to its Ready mode and, if possible, execute the printer's self tests.</p> <p data-bbox="391 841 910 901">If the printer still does not print, replace the cable between A/C-6 (RO) and the printer.</p>
Printer Losing Data	<p data-bbox="391 954 682 979">Busy Flow-Control Problem</p> <p data-bbox="391 1024 979 1117">For serial printers: If the printout is missing characters, make sure that the configuration option Busy is set correctly for the connected printer.</p> <p data-bbox="391 1166 916 1258">For all printers: try an A/C-6 (RO) Test print to determine if characters are lost when it is printed. Make sure that the interface cable is secure.</p> <p data-bbox="391 1307 820 1331">If this is unsuccessful, replace the cable.</p>

**Table K-1. Troubleshooting Chart.**

<b>Problem</b>	<b>Probable Cause and Suggested Action</b>
Garbled Data	<p>Data-Transfer Problem</p> <p>For serial printers: If the printout is not similar to the intended print, check the configuration options Baud Rate, Parity, and Bits per Character.</p> <p>For all printers: Try an A/C-6 (RO) Test print to determine if characters are lost when it is printed. Make sure that the interface cable is secure.</p> <p>If this is still unsuccessful, replace the cable.</p>
Prints Off the Paper	<p>Line-Length Problem</p> <p>If the printer prints beyond the right margin and loses data, the Line Length configuration option should be checked. Set it to the number of characters your printer can print on its carriage. A/C-6 (RO) will then do an automatic New Line when it reaches that point.</p>
Extra Line Feeds	<p>Line Length or Double Space Problem</p> <p>If the printout contains a blank line between each print line, the Line Length configuration option should be checked. Set it to the length of the printer carriage. A/C-6 (RO) will do extra line feeds if set for a line length shorter than the attached printer.</p> <p>Another possible cause is the Double Space configuration option. Set it and any similar switch on the printer to single spacing.</p>

## K.2 Error Messages

Errors are displayed on A/C-6 (RO)'s front-panel LCD. They are listed below in alphabetical order with recommended action.

Error messages can be the result of errors in the syntax of A/C-6 (RO) commands, errors within hex-transfer data streams, or failures during the A/C-6 (RO) self-test. Errors are reported locally only if the Report Errors parameter has not been disabled.

### **EEPROM ERROR** **EEPROM is full**

You have used all the available user-patchable space in A/C-6 (RO)'s EEPROM. Use the Print Config command in the Utilities menu to determine if there are configuration presets or user tables that may be deleted.

The only way to clear configuration presets is to reinitialize the EEPROM, after which you will have to re-enter all necessary configuration and character translation values. The Init EEPROM command is also found in the Utilities menu in configuration mode.

User Tables can be deleted using the Delete Table command. See **Appendix D** for details.

### **EEPROM ERROR** **Not initialized**

Try using the Initialize EEPROM command described in **Section 5.2.4**. If the error persists, the EEPROM is damaged and will not accept new configuration values. The EEPROM chips will have to be replaced.

### **EEPROM ERROR** **Read failure**

A/C-6 (RO) does not recognize what is written in EEPROM. Try to reinitialize the EEPROM (see **Section 5.2.4**). If the error persists, the EEPROM is damaged or corrupted and may have to be replaced.

### **EEPROM ERROR**



### **Write failure**

The EEPROM is damaged and will not accept new configuration values. The EEPROM chips will have to be replaced.

### **COAX INACTIVE**

A/C-6 (RO) has detected an error in the coax line transmission. Check all cables and interfaces.

### **EXTERNAL ERROR**

#### **Printer not ready**

Make sure the printer is properly connected, is powered on, and has paper.

### **FATAL ERROR**

#### **RAM Failure**

The RAM chip is either incorrectly installed, missing, or faulty. If the chip appears to be correctly installed and the error persists, contact technical support.

### **FATAL ERROR**

#### **Watchdog timeout**

An internal program error has been detected. Call for technical support.

### **INVALID KEY**

The front-panel key you pressed has no function at the level or mode you are currently in.

### **ONLY IN SCS**

The function you are trying to use is valid only in SCS printing mode.



© Copyright 1995. Black Box Corporation. All rights reserved.

---

1000 Park Drive • Lawrence, PA 15055-1018 • 724-746-5500 • Fax 724-746-0746