

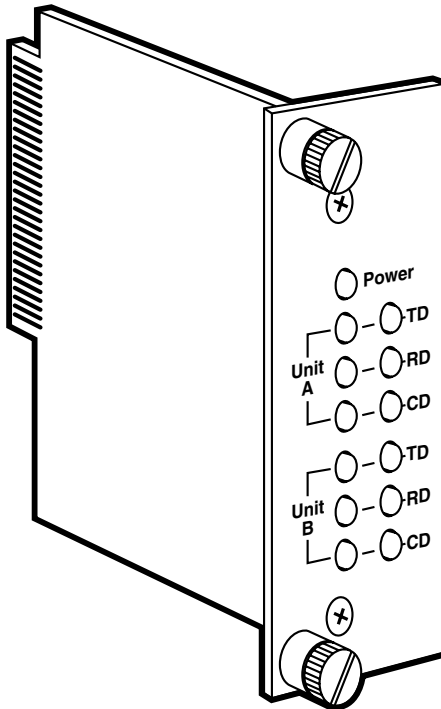

## Async Line Driver Cards



**CUSTOMER  
SUPPORT  
INFORMATION**

Order toll-free in the U.S.: Call 877-877-BBOX (outside U.S. call 724-746-5500)  
FREE technical support 24 hours a day, 7 days a week: Call 724-746-5500 or fax 724-746-0746  
Mailing address: Black Box Corporation, 1000 Park Drive, Lawrence, PA 15055-1018  
Web site: [www.blackbox.com](http://www.blackbox.com) • E-mail: [info@blackbox.com](mailto:info@blackbox.com)

**FEDERAL COMMUNICATIONS COMMISSION  
AND  
INDUSTRY CANADA  
RADIO FREQUENCY INTERFERENCE STATEMENTS**

This equipment generates, uses, and can radiate radio-frequency energy, and if not installed and used properly, that is, in strict accordance with the manufacturer's instructions, may cause interference to radio communication. It has been tested and found to comply with the limits for a Class A computing device in accordance with the specifications in Subpart B of Part 15 of FCC rules, which are designed to provide reasonable protection against such interference when the equipment is operated in a commercial environment. Operation of this equipment in a residential area is likely to cause interference, in which case the user at his own expense will be required to take whatever measures may be necessary to correct the interference.

Changes or modifications not expressly approved by the party responsible for compliance could void the user's authority to operate the equipment.

*This digital apparatus does not exceed the Class A limits for radio noise emission from digital apparatus set out in the Radio Interference Regulation of Industry Canada.*

*Le présent appareil numérique n'émet pas de bruits radioélectriques dépassant les limites applicables aux appareils numériques de la classe A prescrites dans le Règlement sur le brouillage radioélectrique publié par Industrie Canada.*

**TRADEMARKS USED IN THIS MANUAL**

AT&T is a registered trademark of American Telephone and Telegraph Company.

Littelfuse is a registered trademark of Littelfuse, Inc.

*Any other trademarks mentioned in this manual are acknowledged to be the property of the trademark owners.*

**NORMAS OFICIALES MEXICANAS (NOM)  
ELECTRICAL SAFETY STATEMENT**

**INSTRUCCIONES DE SEGURIDAD**

1. Todas las instrucciones de seguridad y operación deberán ser leídas antes de que el aparato eléctrico sea operado.
2. Las instrucciones de seguridad y operación deberán ser guardadas para referencia futura.
3. Todas las advertencias en el aparato eléctrico y en sus instrucciones de operación deben ser respetadas.
4. Todas las instrucciones de operación y uso deben ser seguidas.
5. El aparato eléctrico no deberá ser usado cerca del agua—por ejemplo, cerca de la tina de baño, lavabo, sótano mojado o cerca de una alberca, etc..
6. El aparato eléctrico debe ser usado únicamente con carritos o pedestales que sean recomendados por el fabricante.
7. El aparato eléctrico debe ser montado a la pared o al techo sólo como sea recomendado por el fabricante.
8. Servicio—El usuario no debe intentar dar servicio al equipo eléctrico más allá a lo descrito en las instrucciones de operación. Todo otro servicio deberá ser referido a personal de servicio calificado.
9. El aparato eléctrico debe ser situado de tal manera que su posición no interfiera su uso. La colocación del aparato eléctrico sobre una cama, sofá, alfombra o superficie similar puede bloquea la ventilación, no se debe colocar en libreros o gabinetes que impidan el flujo de aire por los orificios de ventilación.
10. El equipo eléctrico deber ser situado fuera del alcance de fuentes de calor como radiadores, registros de calor, estufas u otros aparatos (incluyendo amplificadores) que producen calor.
11. El aparato eléctrico deberá ser conectado a una fuente de poder sólo del tipo descrito en el instructivo de operación, o como se indique en el aparato.

12. Precaución debe ser tomada de tal manera que la tierra física y la polarización del equipo no sea eliminada.
13. Los cables de la fuente de poder deben ser guiados de tal manera que no sean pisados ni pellizcados por objetos colocados sobre o contra ellos, poniendo particular atención a los contactos y receptáculos donde salen del aparato.
14. El equipo eléctrico debe ser limpiado únicamente de acuerdo a las recomendaciones del fabricante.
15. En caso de existir, una antena externa deberá ser localizada lejos de las líneas de energía.
16. El cable de corriente deberá ser desconectado del cuando el equipo no sea usado por un largo periodo de tiempo.
17. Cuidado debe ser tomado de tal manera que objetos líquidos no sean derramados sobre la cubierta u orificios de ventilación.
18. Servicio por personal calificado deberá ser provisto cuando:
  - A: El cable de poder o el contacto ha sido dañado; u
  - B: Objetos han caído o líquido ha sido derramado dentro del aparato; o
  - C: El aparato ha sido expuesto a la lluvia; o
  - D: El aparato parece no operar normalmente o muestra un cambio en su desempeño; o
  - E: El aparato ha sido tirado o su cubierta ha sido dañada.

# Contents

<b>Chapter</b>	<b>Page</b>
1. Specifications .....	5
2. Introduction .....	8
2.1 Overview .....	8
2.2 Features .....	8
3. Configuration .....	9
3.1 The Configuration Jumpers Illustrated .....	9
3.2 Setting the Configuration Jumpers .....	10
4. Installation .....	15
4.1 The MicroRacks: An Overview .....	15
4.2 The MicroRacks' Power Supply .....	16
4.3 Installing the Async Line Driver Card in the MicroRack .....	17
4.4 The RS-232 Serial Cables and Connectors .....	18
4.5 The Modem-to-Modem Line Cables and Connectors .....	19
5. Operation .....	21
5.1 Status LEDs .....	21
5.2 Power-Up .....	22
6. Troubleshooting .....	23
6.1 Calling Your Supplier .....	23
6.2 Shipping and Packaging .....	23
Appendix: Cable Recommendations .....	24

# 1. Specifications

<b>Hardware Required</b> —	Cards can be installed only in MicroRacks (see <b>Section 4.1</b> )
<b>Cable Required</b> —	For modem-to-modem line: Four-wire unconditioned twisted-pair, 19 to 26 AWG (see the <b>Appendix</b> ), pinned as shown in <b>Section 4.5</b> , unshielded or shielded for European “CE” recommendations
<b>Compliance</b> —	FCC Part 15 Class A, DOC Class/MDC classe A
<b>Interfaces</b> —	Serial: EIA/TIA-561 (compatible with EIA RS-232 and ITU-TSS [CCITT] V.24); Line: Four-wire telco; Internal: Card-edge for module↔MicroRack interconnection
<b>Protocol</b> —	Asynchronous
<b>Data Format</b> —	Transparent to numbers of data bits and stop bits and types of parity
<b>Flow Control</b> —	Transparent to all types of software (X-ON/X-OFF, robust X-ON/X-OFF, etc.) flow control
<b>Operating Mode</b> —	Full duplex
<b>Data Rates</b> —	Transparent to all data rates up to 19,200 bps
<b>Transmit Level</b> —	0 dBm
<b>Maximum Distance</b> —	See the maximum distance chart in the <b>Appendix</b>

## ASYNC LINE DRIVER CARD

### Surge-Protection

**Method —** Silicon Avalanche Diodes

### Surge-Response

**Time —** 1 ps

### Maximum Surge

**Protection —** 600 watts dissipated after 1 ms

### User Controls —

- (7) Jumpers:
  - (2) On main module for carrier handling on Line A and B;
  - (5) On interface module:
    - (2) Connect/disconnect Line A or B Shield

to/from

- Frame Ground;
  - (1) Connect/disconnect Signal Ground to/from Frame Ground;
  - (2) DSR tracks DTR on Line A and B (fixed—can *not* be set differently)

### Indicators —

- (13) Front-panel LEDs:
  - (1) Power;
  - (2) each for TD A, RD A, and CD A;
  - (2) each for TD B, RD B, and CD B

### Connectors —

- On main module:
  - Both models:
    - (1) 50-position card-edge male (to MicroRack);
- On interface module:
  - Both models:
    - (1) 50-position card-edge male (to MicroRack);
    - (2) 10-pin RJ female for modem-to-DTE lines;
  - ME780C-RJ11:
    - (2) RJ-11 female for modem-to-modem lines;
  - ME780C-RJ45:
    - (2) RJ-45 female for modem-to-modem lines

<b>Control Signal</b> —	DCE Mode: CTS (Pin 8) turns ON immediately after the terminal raises RTS (Pin 9); DSR (Pin 2) turns ON immediately after the rack has power; CD (Pin 3) may be constantly “ON” or “normal” (that is, follows presence or absence of RXC signal)
<b>Power</b> —	From MicroRack’s power supply (see <b>Section 4.2</b> ): Input 120 VAC or 240 VAC (user-selectable); Output: 10 VAC; Consumption: 700 mW typical
<b>Fuse</b> —	On MicroRack (see <b>Section 4.2.2</b> ): 400 mA when power supply is set to 120-VAC input; 200 mA when power supply is set to 240-VAC input
<b>Temperature</b> —	32 to 122°F (0 to 50°C)
<b>Humidity</b> —	Up to 95% noncondensing
<b>Maximum Altitude</b> —	15,000 ft. (4572 m)
<b>Size</b> —	Main (front) module: 3.1"H x 1"W x 5.4"D (7.9 x 2.5 x 13.7 cm); Interface (rear) module: 3.5"H x 1"W x 2.9"D (8.9 x 2.5 x 7.4 cm)
<b>Weight</b> —	Total for main and interface modules: 0.2 lb. (0.1 kg)



## 2. Introduction

### 2.1 Overview

The Async Line Driver Card is a dual rack card (it has a main [front] module and an interface [rear] module) incorporating two short-range modems. The Card operates full duplex, at data rates up to 19,200 bps and across distances up to 17 miles (27.4 km), over two twisted pairs. It has 13 easy-to-read front-panel LEDs, so you can monitor the status of data transmission. The Card also incorporates Silicon Avalanche Diodes for protection against the damaging effects of nearby lightning strikes and other harmful transients.

The Async Line Driver Card is fabricated using the latest surface-mount technology, so you get high-quality short-range-modem performance on a convenient rack card. The Card is available with either RJ-11 or RJ-45 line-interface connectors on its interface (rear) module. It fills one function-card slot in our MicroRacks (RM202, RM204, RM208, or RM216).

### 2.2 Features

- Convenient rack card features two short-range modems
- Data rates to 19.2 kbps, distances to 17 miles (27.4 km)
- Full-duplex operation
- Silicon Avalanche Diode surge protection
- Thirteen front-panel LEDs show you status at a glance
- Fits conveniently in our MicroRacks (RM202, RM204, RM208, RM216)

## 3. Configuration

This chapter describes the locations and possible settings of the Async Line Driver Card's configuration jumpers ("straps"), and provides detailed instructions for setting the jumpers. Once you've configured the Async Line Driver Card, it is designed to operate transparently, without needing to be frequently reconfigured. Just set it and forget it!

### 3.1 The Configuration Jumpers Illustrated

Figure 3-1, below, shows the possible settings of the Async Line Driver Card's jumpers. Each jumper can be either on pegs 1 and 2, as shown at left, or on pegs 2 and 3, as shown at right.

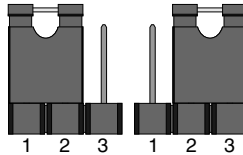

**Figure 3-1. The possible jumper settings.**

## 3.2 Setting the Configuration Jumpers

The Async Line Driver Card has two different sets of jumpers. One set is on the main (front) module, and is described in **Section 3.2.1**. The other set is on the interface (rear) module, and is described in **Section 3.2.2**.

### 3.2.1 THE JUMPERS ON THE MAIN MODULE

The Async Line Driver Card has two jumpers on its main (front) module, as shown in Figure 3-2 below.

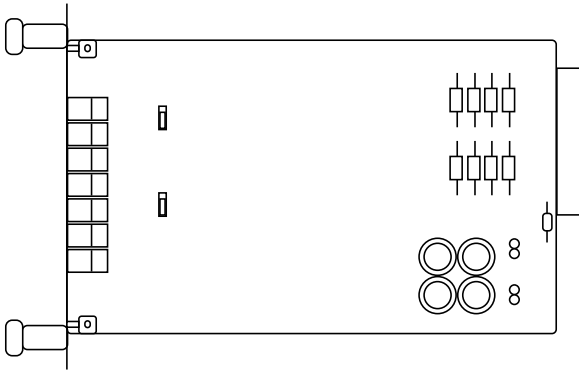

**Figure 3-2. The main-module jumpers.**

With these jumpers, you can individually set how each of the Card's two modems handles the Received Line Signal Detector (RLSD) signal, normally referred to as "Carrier Detect" ("CD"). Use jumper JB1 to control Carrier Detect on Unit A; use jumper JB2 to control the signal on Unit B, as shown in Table 3-1 at the top of the next page.

Each of these jumpers can be set to either "Normal" (positions 1 and 2) or "Always on" (positions 2 and 3). When you set a jumper to "Normal," the corresponding modem will turn its CD signal and CD front-panel LED *on* when carrier is present and *off* when carrier is absent. When you set a jumper to "Always on," the corresponding modem will keep its CD signal and CD front-panel LED constantly *on*.

Table 3-1. Summary of Main-Module Jumper Functions

Jumper	Function	Pos. 1 and 2	Pos. 2 and 3
JB1	Carrier Detect—Unit A	Normal	Always on*
JB2	Carrier Detect—Unit B	Normal	Always on*
*factory-default settings			

### 3.2.2 THE JUMPERS ON THE INTERFACE MODULE

The Async Line Driver Card has two interface-module options. The ME788C-RJ11 model comes equipped with two RJ-11 line-interface ports and two 10-pin RJ-style serial-interface ports. The ME788C-RJ45 model comes equipped with two RJ-45 line-interface ports and two 10-pin RJ-style serial-interface ports. Figure 3-3, below, shows these two different interface-module options.

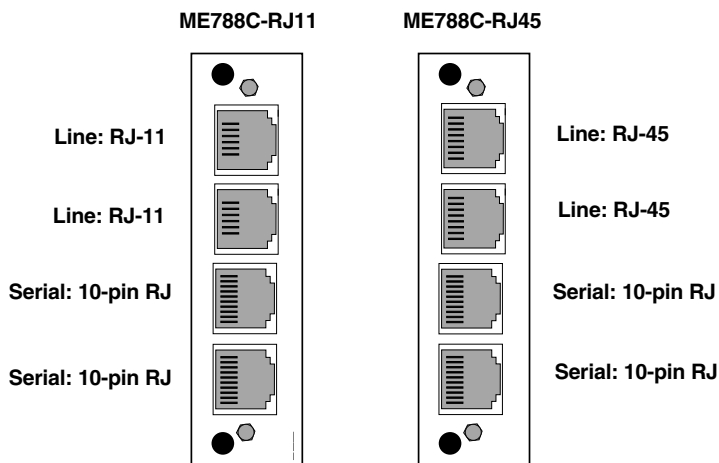

Figure 3-3. The two interface modules.

Before you install the Card, you should examine the interface module you have selected and make sure that it is configured for your application. Each interface module has five jumpers on its circuit board, as described in the rest of this section.

## ASYNCR LINE DRIVER CARD

Figure 3-4, below, shows the locations of the jumpers on the interface modules (the locations are the same for both the -RJ11 and -RJ45 models). These jumpers determine various grounding and signal characteristics for the modem-to-modem and serial lines.

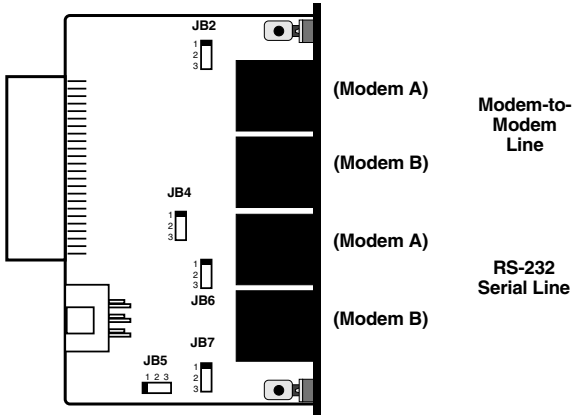

Figure 3-4. The jumper locations.

Table 3-2, below, provides a summary of the functions of these jumpers. The functions are described in more detail afterward.

Table 3-2. Summary of Interface-Module Jumper Functions

Jumper	In Positions 1 and 2	In Positions 2 and 3
JB2	Line A Shield	No Shield*
JB4	Line B Shield	No Shield*
JB5	SGND tied to FGND <sup>†</sup>	SGND not tied to FGND*
JB6	DSR A tracks DTR*	N/A
JB7	DSR B tracks DTR*	N/A

\* factory-default settings

<sup>†</sup> via a 100-ohm resistor

**Line Interface: Line A Shield and Line B Shield (JB2 and JB4)**

These jumpers apply to the line interface. When one of these jumpers is in positions 1 and 2, it links RJ-11 Pins 1 and 6 or RJ-45 Pins 2 and 7 on the corresponding line to the interface module's frame ground. (If you are using shielded twisted-pair cable, the shield can be connected to these pins.) In positions 2 and 3, Pins 1 and 6 or 2 and 7 remain connected to each other, but are disconnected ("lifted") from frame ground.

**JB2**

Positions 1 and 2 = Line A Shield Connected

Positions 2 and 3 = No Shield (default)

**JB4**

Positions 1 and 2 = Line B Shield Connected

Positions 2 and 3 = No Shield (default)

**CAUTION!**

**If you connect shield to frame ground, make sure that RJ-11 Pins 1 and 6 or RJ-45 Pins 2 and 7, as well as the cable shield, are connected to ground at one end of the cable only. Connecting them at both ends of the cable will defeat the transformer isolation and will leave your system open to damage from ground loops.**

**Serial Interface: Signal Ground and Frame Ground (JB5)**

This jumper applies to the serial interface. In position 1 and 2, this jumper links the Signal Ground (SGND) line (Pin 5) of both serial lines to the interface module's frame ground (FGND) through a 100-ohm, ½-watt resistor. When this jumper is in positions 2 and 3, Pin 5 of both lines are disconnected ("lifted") from frame ground.

**JB5**

Positions 1 and 2 = SGND and FGND Connected

Positions 2 and 3 = SGND and FGND Not Connected (default)

### **DSR tracks DTR (JB6 and JB7)**

These jumpers must be left in their default positions. Because the interface module is designed to work with a whole family of products, and not just the Async Line Driver Card, it is capable of supporting some functions that are not used by the Async Line Driver Card. Some products in this family might require these jumpers to be set differently, but the Async Line Driver Card might malfunction if either of these jumpers is in the wrong position. Make sure the jumper is placed across Pins 1 and 2. Do *not* place the jumper across Pins 2 and 3.

#### JB6

Positions 1 and 2 = DSR Tracks DTR (default)

Positions 2 and 3 = N/A

## 4. Installation

This chapter describes the functions of the MicroRacks, tells how to install the front and rear modules of the Async Line Driver Cards in them, and provides diagrams for wiring the interface connections correctly.

### 4.1 The MicroRacks: An Overview

Async Line Driver Cards are designed to be installed in our MicroRacks (product codes RM202 for the 2-card models, RM204 for the 4-card models, RM208 for the 8-card models, and RM216 for the 16-card models). You will install Async Line Driver Cards in any MicroRack the same way.

As an example of these products, the MicroRack 16, shown in Figure 4-1 below, features sixteen slots for short-range modem cards, plus its own power supply. Measuring only 3.5" (8.9 cm) high, the MicroRack 16 is designed to occupy only 2U in a 19" rack. Sturdy front handles allow the MicroRack 16 to be extracted and transported conveniently.

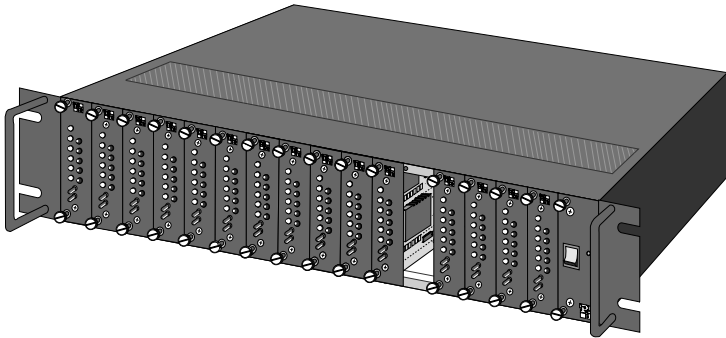

**Figure 4-1. The MicroRack 16 (shown with line-driver cards of a different type installed).**



### 4.2 The MicroRacks' Power Supply

The power supply included with the MicroRacks uses the same mid-plane architecture as the line-driver cards. Slide the front module of the power supply into the MicroRack from the front, and slide the rear module in from the rear. The two modules plug into one another in the middle of the rack. Secure the front module with thumbscrews and the rear module with conventional metal screws; these screws and thumbscrews come with the rack.

#### 4.2.1 SWITCHING THE POWER SUPPLY ON AND OFF

The MicroRack's power switch is located on the power supply's front panel. When the MicroRack is plugged in and switched on, the power supply will light the red LED on its front panel. Since the MicroRack is a "hot-swappable" rack, *you don't have to install any cards before switching on the power supply.* Also, the power supply may be switched off at any time without harming the installed cards, and you can install or remove cards without turning off the power supply. However, you should always unplug the power cord before removing, replacing, or switching the power supply or its fuses.

#### 4.2.2 REPLACING THE POWER SUPPLY'S FUSE

The MicroRack's power supply uses a 400-mA fuse for 120-VAC circuits, and a 200-mA fuse for 240-VAC circuits. The fuse compartment is located just below the AC socket on the power supply's rear module. To replace the fuse, follow these steps:

1. Making sure the rack is turned off and unplugged, use a small screwdriver to pop the compartment open: It will slide open like a drawer.
2. Notice that there are two fuses in the compartment: The rear fuse is "active," and the front fuse is the "spare."
3. If the active fuse appears to be blown, remove it from the clips and replace it with the spare from the front of the compartment. Note the size and rating of the blown fuse before discarding it.
4. Order a new replacement fuse. Both the 400-mA fuses (Littelfuse® 239.400 or equivalent) and the 200-mA fuses (Littelfuse 239.200 or equivalent) measure 5 x 20 mm.

### CAUTION!

**For continued protection against the risk of fire, replace blown fuses only with fuses of the same type and rating.**

### **4.2.3 SWITCHING THE POWER SUPPLY BETWEEN 120 AND 240 VOLTS**

Although the MicroRack is shipped from the factory with a customer-specified power-supply configuration, you may change the configuration yourself. Follow these steps to switch the configuration of the power supply between 120 VAC and 240 VAC:

1. Making sure the rack is turned off and unplugged, remove the power supply's front module and locate the two-position switch (labeled either "110/220" or "115/230") near the back of the card. Slide the switch to the setting corresponding to your desired voltage.
2. Replace the existing fuses with fuses of the correct type (see step 4 of **Section 4.2.2**).
3. If necessary, replace the power-supply cord with a country-specific cord. (For certain countries, your supplier might be able to give you a special quote on country-specific cords.) Plug the cord back in.

### **4.3 Installing the Async Line Driver Card in the MicroRack**

The Async Line Driver Card is made up of a main (front) module and an interface (rear) module. The two cards meet inside the rack chassis; their mating 50-pin card-edge connectors plug into each other. Use these steps to install each Async Line Driver Card into a MicroRack:

1. Slide the rear module into the back of the MicroRack on the metal rails.
2. Secure the rear module using the included metal screws.
3. Slide the front module into the front of the chassis. It should meet the rear module when it is almost completely in the chassis.
4. Push the front module gently into the card-edge receptacle of the rear module. It should "click" into place.
5. Secure the front module using the thumbscrews.

#### **NOTE**

**Since the MicroRacks allow "hot swapping" of cards, it is not necessary to power down the rack when you install or remove an Async Line Driver Card.**

## 4.4 The RS-232 Serial Cables and Connectors

The Async Line Driver Card's RS-232 ports are always the *lower* two ports on its interface module. They are 10-pin female RJ-style connectors (compatible with regular male RJ-45 cable connectors), pinned according to a modified version of the EIA/TIA-561 standard, as shown in Table 4-1 below.

**Table 4-1. The 10-Wire RJ Interface**

<b>Pin Number</b>	<b>ITU-TSS V.24 Circuit</b>	<b>Signal Name/Description</b>
1	N/A	Not Used
2	107	DCE Ready (DCR [DSR])
3	109	Received Line Signal Detector (RLSD [CD])
4	108/2	DTE Ready (DTR)
5	102	Signal Common (SCOM [SGND])
6	104	Receive Data (RD)
7	103	Transmitted Data (TD)
8	106	Clear to Send (CTS)
9	105 or 133	Request to Send (RTS)/Ready for Receiving (RR)
10	N/A	Not Used

Pins 3 through 9 correspond to Pins 2 through 8 of the EIA/TIA-561 non-synchronous interface standard. Pin 2 corresponds to Pin 1 of the EIA/TIA TSB-25 preliminary interface standard.

### **NOTE**

**European “CE” recommendations require that any terminal cable connected to the Async Line Driver Card must be shielded cable, and the outer shield must be 360° bonded—at both ends—to a metal or metalized backshell.**

The Async Line Driver Card is wired as a DCE (Data Communications Equipment) device. Therefore, it would normally be connected to DTE (Data Terminal Equipment) RS-232 devices. You might need to run a special cable or use a special modular adapter if the serial ports of either of the RS-232 devices you want to attach are DB25 or DB9 connectors. Even if the DTEs' serial ports are RJ-45 connectors, you might still need to use a specially pinned cable. Call your supplier for technical support with these issues, or if you want to attach a DCE device to the Card.

## 4.5 The Modem-to-Modem Line Cables and Connectors

The Card's line ports are always the *upper* two ports on its interface module. They are 6-pin RJ-11 connectors on the ME780C-RJ11 model or 8-pin RJ-45 connectors on the ME780C-RJ45 model, pinned for a standard telco-wiring environment (see Table 4-2 and Figure 4-2). Connecting a 4-wire twisted-pair circuit between 2 or more Cards requires a crossover cable.

The Async Line Driver Card operates full duplex over four wires (two twisted pairs). In all applications, the twisted-pair wire must be 26 AWG or thicker, unconditioned, dry, and metallic. Both shielded and unshielded cable yield favorable results.

### NOTE

**The Async Line Driver Card can only communicate in a closed data circuit with another Async Line Driver Card. It will not work with dialup analog circuits, such as those used with standard modems. For further information about acceptable wire grades, refer to the recommendations in the Appendix.**

### NOTE

**European "CE" recommendations require that any modular twisted-pair cable connected to the Async Line Driver Card must be shielded cable, and the outer shield must be properly terminated to a shielded modular plug on both ends of the cable.**

The modem-to-modem cable connection must be specially cross-pinned, as shown in Table 4-2 and Figure 4-2 on the next page. If your cabling includes punchdown blocks, you can easily do the cross-pinning at a punchdown block. If you will be running cable directly between two Async Line Driver Cards, you can get a custom cable from your supplier as a special quote, or you can use regular straight-through-pinned cable and repin one of the RJ connectors (that is, rearrange the wiring connections between the terminal block and the actual contacts). You might need special crimping tools or new connectors; call your supplier for these items, or for technical support if you have difficulty.

**Table 4-2. Line-Cable Pinouts**

RJ-11

SIGNAL	PIN#	COLOR*	COLOR*	PIN#	SIGNAL
GND**	1	Blue .....	White	6	GND**
RCV-	2	Yellow.....	Red	4	XMT-
XMT+	3	Green .....	Black	5	RCV+
XMT-	4	Red.....	Yellow	2	RCV-
RCV+	5	Black .....	Green	3	XMT+
GND**	6	White .....	Blue	1	GND**

RJ-45

SIGNAL	PIN#	COLOR*	COLOR*	PIN#	SIGNAL
GND**	2	Orange .....	Brown	7	GND**
RCV-	3	Black .....	Green	5	XMT-
XMT+	4	Red.....	Yellow	6	RCV+
XMT-	5	Green .....	Black	3	RCV-
RCV+	6	Yellow.....	Red	4	XMT+
GND**	7	Brown .....	Orange	2	GND**

\*Standard color codes—wire colors in your cable might be different

\*\*Connection to ground is optional

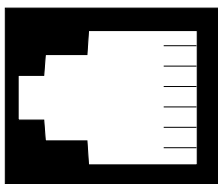

- 1 - Blue
- 2 - Yellow
- 3 - Green
- 4 - Red
- 5 - Black
- 6 - White

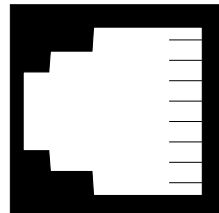

- 1 - Blue
- 2 - Orange
- 3 - Black
- 4 - Red
- 5 - Green
- 6 - Yellow
- 7 - Brown
- 8 - Slate

**Figure 4-2. AT&T® standard modular color codes.**

## 5. Operation

Once you have configured each Async Line Driver Card and connected the cables, you are ready to operate the units. This chapter describes the Card's LEDs and the power-up procedure.

### 5.1 Status LEDs

The Async Line Driver Card features 13 front-panel status LEDs (shown in Figure 5-1 below) that indicate the condition of the modem and the communication link.

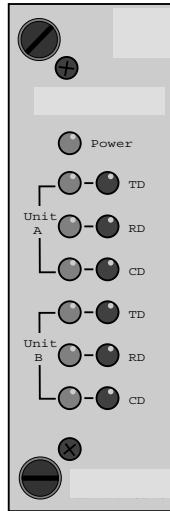

**Figure 5-1. The Card's front panel.**

- The Card will steadily light its green “PWR” LED as long as it is receiving power through its mid-plane MicroRack connection.
- The green “TD” and “RD” LEDs blink to show positive-state data activity. The red “TD” and “RD” LEDs blink to show negative-state data activity. If the red LEDs are steadily lit, the modem-to-modem connection for that unit is idle. If the green LEDs are steadily lit, there is an “illegal” condition, which typically indicates that there is a problem in the system.

- If the main-module Carrier Detect jumper for the corresponding modem is set to “Always on” (see **Section 3.2.1**), the green “CD” LED will always be lit. If the jumper is set to “Normal,” the Card will light the green LED when carrier is present and the red LED when carrier is absent.

### 5.2 Power-Up

There is no power switch on the Async Line Driver Card: Power is automatically applied to the Card whenever—and for as long as—its card-edge connector is plugged into the MicroRack’s mid-plane socket and the MicroRack’s power supply is turned on.

#### NOTE

**The Async Line Driver Card is a “hot-swappable” card—it will not be damaged by plugging it in or removing it while the rack is powered up.**

## 6. Troubleshooting

### 6.1 Calling Your Supplier

If you determine that your Async Line Driver Card is malfunctioning, *do not attempt to alter or repair it*. Contact your supplier. The problem might be solvable over the phone.

Before you do, make a record of the history of the problem. Your supplier will be able to provide more efficient and accurate assistance if you have a complete description, including:

- The nature and duration of the problem.
- When the problem occurs.
- The components involved in the problem.
- Any particular application that, when used, appears to create the problem or make it worse.

### 6.2 Shipping and Packaging

If you need to transport or ship your Async Line Driver Card:

- Package it carefully. We recommend that you use the original container.
- Before you ship a unit for repair or return, contact your supplier to get a Return Authorization (RA) number, and make sure you include everything you received with the unit when you ship it.



# Appendix: Cable Recommendations

The Async Line Driver Card operates at frequencies of 20 KHz or less and has been performance-tested using twisted-pair cable with these characteristics:

Wire Gauge	Capacitance	Resistance
19 AWG	83 nf/mi. or 15.72 pf/ft.*	16.3 Ω/1000 ft. (53.5 Ω/km)
22 AWG	83 nf/mi. or 15.72 pf/ft.*	32.6 Ω/1000 ft. (107 Ω/km)
24 AWG	83 nf/mi. or 15.72 pf/ft.*	51.65 Ω/1000 ft. (169.5 Ω/km)

\*Alternatively, 51.6 nf/km or 51.6 pf/m

Bench tests yield the following data-rate/maximum-distance results:

Data Rate in bps	Maximum Distance in miles (km)		
	19 AWG	22 AWG	24 AWG
19,200	6.2 (10)	3.7 (6)	1.2 (1.9)
9,600	7.5 (12)	4.9 (7.9)	2.5 (4)
4,800	8.7 (14)	5.6 (9)	3.7 (6)
2,400	11.8 (19)	8 (12.9)	4.9 (7.9)
1,200	17 (27.4)	11.8 (19)	8 (12.9)

Many environmental factors can affect the maximum distances obtainable at a particular site. Use this table as a general guideline only.

To gain optimum performance from the Async Line Driver Card, please keep these guidelines in mind:

- Always use twisted-pair cable—this is *not* an option.
- Use twisted-pair cable with a capacitance of 20 pf/ft. (65.6 pf/m) or less.
- Avoid twisted-pair cable thinner than 26 AWG (that is, avoid higher AWG numbers than 26).
- Using twisted-pair cable with a resistance greater than that listed at the top of this page might reduce the maximum distance you can run the cable, but should not otherwise affect your system.

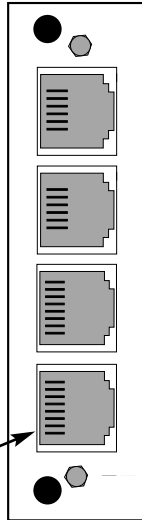

**For all modular jacks  
(6-, 8-, or 10-position):  
Pin 1 is always toward the  
bottom when the rear card is  
oriented correctly in the slot.**



© Copyright 1996. Black Box Corporation. All rights reserved.

---

1000 Park Drive • Lawrence, PA 15055-1018 • 724-746-5500 • Fax 724-746-0746