

MDS920C-E1

MDS920C-2E1

MDS921AE-E1

MDS923AE

MDS923AE-V35X21

MDS923C-V35X21

## Operating Manual and Repeater Manual

**Document Version** 1.63  
**Document Revision** 20. March 2003

© Copyright ©2002 by BLACK BOX Network Services AG. The contents of this publication may not be reproduced in any part or as a whole, transcribed, stored in a retrieval system, translated into any language, or transmitted in any form or by any means, electronic, mechanical, magnetic, optical, chemical, photocopying, manual, or otherwise, without the prior written permission of BLACK BOX Network Services AG. All rights reserved.

## Version Control

---

Version of Operating Manual	Version of Related Firmware	Major changes to previous version
1.0	0.2.2.0	Initial Version.
1.1	0.3.0.0	Update
1.2	1.0.3.0	Update
1.4	1.2.0.0	Update
1.5	1.3.0.0	Update
1.6	1.6.4.0	Update
1.6.1	1.6.5.0	Update
1.6.2	STU:1.6.5.4 SRU: 1.6.4.1	Update. Adding ADD-DROP.
1.6.3	STU: 1.6.8.2 & 1.7.1.2 SRU: 1.6.6.2	Update. Remote Powering.

### Warnings

Please read this manual carefully before operating the system.

Installation of this equipment has to be done by qualified personnel only.

To achieve safety and satisfactory EMC performance, the LTU board has to be inserted into the sub-rack. Sub-rack slots that are not used have to be covered with a blanking plate.

The sub-rack must be bonded to earth. This is usually achieved by installing the sub-rack into a rack, which is connected to the earth network according to ETS 300 253. An extra earth terminal is not provided.

# Contents

---

<b>1</b>	<b>THE BLACK BOX-DSL FAMILY</b>	<b>8</b>
<b>2</b>	<b>LTU FRONT PANEL DESCRIPTION</b>	<b>12</b>
<b>3</b>	<b>NTU AND REPEATER PANEL DESCRIPTION</b>	<b>1</b>
<b>4</b>	<b>CONFIGURATION OPTIONS</b>	<b>17</b>
4.1	xDSL	17
4.1.1	<i>Master / Slave</i>	17
4.1.2	<i>Repeater xDSL interfaces</i>	18
4.1.2.1	N-side xDSL interface operating modes	18
4.1.2.2	C-side xDSL interface operating modes	18
4.1.3	<i>Normal/Dual pair mode</i>	18
4.2	E1-INTERFACE (2 MBIT/S G.703 / G.704)	18
4.2.1	<i>Framing</i>	18
4.2.1.1	Transparent Mode	18
4.2.1.2	Framed Mode ITU-T G.704	19
4.2.2	<i>CRC4DET Option</i>	19
4.2.3	<i>CRC4GEN Option</i>	19
4.2.4	<i>E-bit Insertion</i>	19
4.2.5	<i>AIS Generation</i>	20
4.2.6	<i>AIS Detection</i>	20
4.2.7	<i>Transmission of TS16</i>	20
4.2.8	<i>E1 - Clock Modes</i>	20
4.2.9	<i>Synchronous and plesiochronous operation</i>	21
4.3	Nx64 INTERFACE (DCE)	22
4.3.1	<i>Nx64 Services</i>	22
4.3.2	<i>Nx64 Clock Directions</i>	23
4.3.3	<i>Nx64 Clock Modes</i>	23
4.3.4	<i>Nx64 Block Diagram</i>	24
4.3.5	<i>Automatic V.54 loops</i>	25
4.4	MULTIPOINT OPERATION	26
4.5	ADD-DROP OPERATION	27
4.6	TEST LOOPS	28
4.6.1	<i>Standard Test Loops</i>	28
4.6.2	<i>Analog Loop Back</i>	28

<b>5</b>	<b>PERFORMANCE MONITORING</b>	<b>29</b>
5.1	G.826 PERFORMANCE MONITORING	29
<b>6</b>	<b>ALARMS</b>	<b>31</b>
6.1	GENERAL	31
6.2	LEDS	31
6.2.1	<i>Status LEDs LTU/NTU (except Multipoint Mode)</i>	31
6.2.2	<i>Status LEDs LTU/NTU (Multipoint Mode)</i>	32
6.2.3	<i>Status LEDs ADD_DROP Repeater</i>	32
6.2.4	<i>Local LED - Alarm Conditions</i>	33
6.2.4.1	Local (NE) LED	33
6.2.4.2	Remote (FE) LED	33
6.3	ALARM RELAYS LTU	34
6.3.1	<i>Implementation</i>	34
6.3.2	<i>Relay - Alarm Conditions</i>	34
6.4	ALARM RELAYS NTU AND REPEATER	34
6.4.1	<i>Implementation</i>	34
6.4.2	<i>Relay - Alarm Conditions</i>	34
<b>7</b>	<b>LTU POWER CONCEPT</b>	<b>35</b>
7.1	POWER MODES (ON REQUEST)	35
7.1.1	<i>Wetting current source</i>	35
7.1.2	<i>Wetting current receipt</i>	35
7.1.3	<i>2x100V power mode</i>	35
7.1.4	<i>1x200V power mode</i>	36
7.1.5	<i>Power jumpers</i>	36
7.1.6	<i>Remote power concept</i>	37
7.2	WETTING CURRENT (MDS923C-V35X21 AND MDS920C-2E1)	38
<b>8</b>	<b>NTU POWER CONCEPT</b>	<b>39</b>
<b>9</b>	<b>MONITOR</b>	<b>40</b>
9.1	GENERAL	40
9.2	MONITOR INTERFACE	40
9.3	STRUCTURE & ORGANIZATION	41
9.3.1	<i>Main Menu</i>	45
9.3.2	<i>Common Commands</i>	45
9.3.2.1	HELP Command	45
9.3.2.2	MAIN Command	45
9.3.2.3	CONNECT Command	45
9.3.2.4	DISCONNECT Command	46
9.3.3	<i>Performance management PM</i>	46
9.3.3.1	G826 Command	46
9.3.3.2	G826 E1 Command	47
9.3.3.3	RESETG826 Command	47

<i>9.3.4 Fault and maintenance management FMM</i>	47
9.3.4.1 SQ Command	48
9.3.4.2 STARTUP Command	48
9.3.4.3 STATUS Command	48
9.3.4.4 ALARM Command	49
9.3.4.5 LOOP1 Command	50
9.3.4.6 LOOP2 Command	50
9.3.4.7 STARTAL Command	50
9.3.4.8 SPECTRUM Command	51
9.3.4.9 RESTART Command	51
9.3.4.10 RESET Command	51
<i>9.3.5 Configuration management CM</i>	51
9.3.5.1 CONFIG Command	51
9.3.5.2 G704 Command	52
9.3.5.3 CRC4DET Command	52
9.3.5.4 CRC4GEN Command	52
9.3.5.5 EBIT Command	52
9.3.5.6 AISGEN Command	52
9.3.5.7 AISDET Command	52
9.3.5.8 EXTCLK Command	52
9.3.5.9 SERVICE Command	53
9.3.5.10 TYPE Command	53
9.3.5.11 BITRATE Command	53
9.3.5.12 CLOCKMODE Command	53
9.3.5.13 CLOCKDIR Command	53
9.3.5.14 CLOCKEGDE Command	53
9.3.5.15 SLOTUSAGE Command	53
9.3.5.16 AUTOLOOP Command	54
9.3.5.17 MODE Command	54
9.3.5.18 MASTER Command	54
9.3.5.19 PLL Command	54
9.3.5.20 ID Command	54
9.3.5.21 RESTART Command	54
9.3.5.22 BASERATE Command	54
9.3.5.23 PCM Command	54
9.3.5.24 IDLECAS Command	55
9.3.5.25 PAYLOAD Command	55
9.3.5.26 TS0SRC Command	55
9.3.5.27 ADAPTIVE Command	55
9.3.5.28 POWER Command	55
9.3.5.29 DEFAULT Command	55
9.3.5.29.1 E1 only Normal or Dual Pair mode	55
9.3.5.29.2 Nx64 only Normal or Dual Pair mode	56
9.3.5.29.3 fE1 & Nx64 Normal or Dual Pair mode	58

9.3.5.29.4	Multipoint Mode	59
9.3.5.29.5	Add-Drop Repeater	61
<b>10</b>	<b>SOFTWARE UPDATE</b>	<b>62</b>
10.1	GENERAL	62
10.2	SOFTWARE DOWNLOAD	62
<b>11</b>	<b>CONNECTORS' DESCRIPTION</b>	<b>67</b>
11.1	xDSL CONNECTOR (MDS923C-V35X21 AND MDS920C-2E1)	67
11.2	xDSL CONNECTOR	67
11.3	E1 120 OHM CONNECTOR	68
11.4	E1 75 OHM IN / OUT CONNECTORS	68
11.5	V.35 DCE CONNECTOR	69
11.6	MONITOR INTERFACE	70
Signal		70
11.7	POWER INTERFACE (MDS921AE-E1 AND MDS923AE-V35X21)	70
11.8	POWER INTERFACE	70
<b>12</b>	<b>TECHNICAL SPECIFICATION</b>	<b>71</b>
12.1	INTERFACES	71
12.1.1	<i>xDSL Line Interface</i>	71
12.1.2	<i>E1 Line Interface</i>	71
12.1.3	<i>V.35 DCE User Interface</i>	71
12.1.4	<i>Monitor Interface</i>	72
12.2	POWER SUPPLY	72
12.3	ENVIRONMENTAL	72
12.3.1	<i>Climatic Conditions</i>	72
12.3.2	<i>Safety / EMC</i>	72
12.4	PHYSICAL DIMENSIONS AND WEIGHT	72
<b>13</b>	<b>NX64 CABLES</b>	<b>73</b>
<b>14</b>	<b>APPENDICES</b>	<b>76</b>
14.1	INITIALIZATION ERRORS	76
14.2	ABBREVIATIONS	77
14.3	REFERENCES	79
14.3.1	<i>Standards</i>	79

**FIGURES**

FIGURE 2-1: SUBRACK FRONT PANEL (E1 120 Ω)..... 12

FIGURE 2-2: SUBRACK FRONT PANEL (E1 75 Ω)..... 13

FIGURE 2-3: DUAL SUBRACK FRONT PANEL (E1 75 Ω) ..... 14

FIGURE 3-1: NTU AND REPEATER TABLETOP REAR PANEL ..... 15

FIGURE 3-2: NTU AND REPEATER TABLETOP UP VIEW ..... 16

FIGURE 4-1: EXTERNAL CLOCK MODE ..... 20

FIGURE 4-2: CLOCK SOURCES ..... 21

FIGURE 4-3: SYNCHRONOUS OPERATION..... 22

FIGURE 4-4: PLESIOCHRONOUS OPERATION ..... 22

FIGURE 4-5: Nx64 BLOCK DIAGRAM ..... 24

FIGURE 4-6: STANDARD TEST LOOPS..... 28

FIGURE 5-1: G.826 PERFORMANCE EVALUATION..... 29

FIGURE 7-1: LTU CURRENT JUMPER LOCATIONS ..... 36

FIGURE 7-2: CURRENT LIMITER STATE MACHINE ..... 37

FIGURE 7-3: LTU WETTING CURRENT JUMPER LOCATIONS ..... 38

FIGURE 8-1: NTU WETTING CURRENT JUMPER LOCATIONS..... 39

FIGURE 9-1: LTU/NTU MONITOR COMMAND SET TREE (NORMAL/DUAL PAIR MODES)..... 42

FIGURE 9-2: LTU/NTU MONITOR COMMAND SET TREE (MULTIPOINT MODE)..... 43

FIGURE 9-3: ADD-DROP REPEATER MONITOR COMMAND SET TREE ..... 44

## The BLACK BOX-DSL Family

### The Universal Access Platform

DSL, FTTB, DPGS, TDM, X-Connect, SDH... Why should I have it all in different packages? If you ask yourself this very common nowadays question, you are probably the most welcomed customer for our Universal Access Platform .

It combines in a single platform many popular and needed access solutions:  
BLACK BOX-DSL - Full range of symmetrical DSL modems

### The BLACK BOX-DSL series of symmetrical DSL modems

BLACK BOX-DSL is a wide range of DSL modems targeted to meet both typical carrier applications and access network needs. BLACK BOX-DSL is a really flexible DSL solution. Depending on your country or PTT requirements as well as your own technology preference you may choose within BLACK BOX-DSL series one of the three line coding options. It is new Conexant based 1 pair 2B1Q technique (BLACK BOX-DSL MDSL), advanced in terms of distance Globespan CAP technology (BLACK BOX-DSL MSDSL) and the newest, ITU standardized and most spectral friendly TC-PAM coding (BLACK BOX-DSL PAM). Any modem of the BLACK BOX-DSL series can be delivered in three types of mechanics designed to meet CO, campus and SOHO needs. It is subrack plug-in card version for installation into universal 19' 6U MDS920AE-RMDC subrack, minirack version 19" 1U for direct installation into 19" rack or stand alone version for desk top use.

For transmission distance increasing of BLACK BOX-DSL PAM series repeaters (Signal Regenerator Units - SRU) are available. These units can be delivered in three types of mechanical design: stand alone version for desk top use, IP67 design for installation into outdoor cabinet and underground mountable fully isolated stainless steel design.

### The BLACK BOX-DSL PAM New Generation modems - technology

BLACK BOX-DSL PAM New Generation is based on the latest developed DSL line technology - TC-PAM. TC-PAM was designed to provide both superior distance and full electro-magnetic spectral compatibility with other DSL services running in one cable. TC-PAM is laid into the base of ANSI HDSL2 as well as ETSI SDSL standards. It is going to be also the first international ITU G.shdsl standard for symmetrical 1-pair high-speed data transmission over existing copper pair.

Giving to customer an option to choose any line-speed from 72kbps to 2.3Mbps with 8kbps increments, TC PAM offers more narrow power spectrum then other technologies like 2B1Q. This way new technology allows longer distance transmission over copper pair as well as spectral compatibility with many other DSL services like ISDN, ADSL, and G.lite.



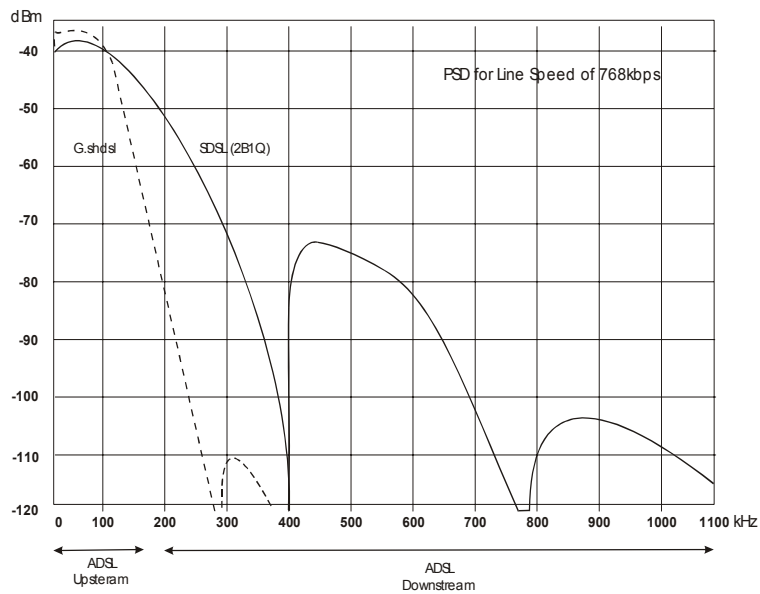

With a fixed loop length TC-PAM provides 35-45% higher data rate in comparison with traditional 2B1Q technique. Having the data rate fixed, TC-PAM runs on 15-20% longer loops than 2B1Q.

BLACK BOX-DSL PAM New Generation modems provide also a unique *wetting current* option. When the cable network is worn up, contact points in cable connections are often not in their best conditions. It may lead to the situation when even not-too-long pairs suitable for POTS voice connections cannot be used for DSL transmission. With *wetting current* option LTU sends to the loop low voltage signal to 'wet' the bad contact and this way cure it. Our long-term experience in Eastern European markets shows that *wetting current* options can dramatically increase number of pairs usable for DSL installations.

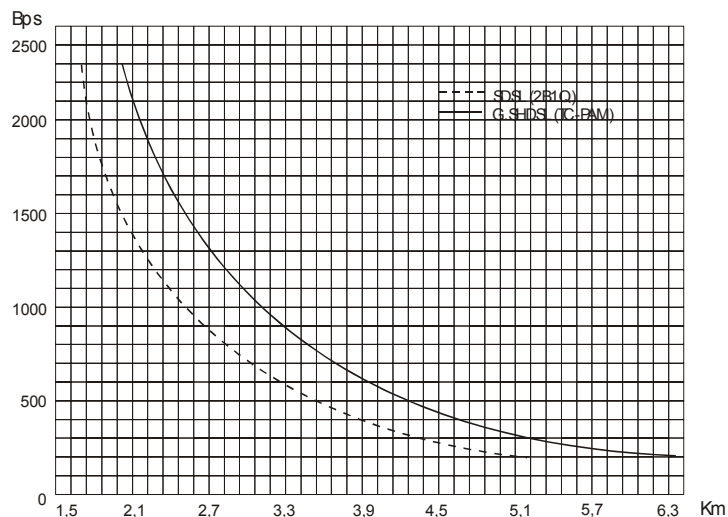

Data are given for the worst case scenario, BER10-7, wire 0,4 mm

## **BLACK BOX-DSL PAM New Generation modems - capabilities and user interfaces**

BLACK BOX-DSL PAM series include three user interface options - G.703/704, N\*64 (V.35/36, X.21), Ethernet 10BaseT. Line and user interface speed can be adjusted from 192kbps up to 2.3Mbps in 8 or 64 kbps steps.

Industry standard G.703/704 interface is optimal for PBX, remote concentrators, DLC and TDM multiplexer's connections. Digital interfaces V.35/36 or X.21 are very popular for campus point-to-point applications and terminal data equipment (like routers, PADS, FRADS) connections. Ethernet 10BaseT is the best option for Internet access as well as for LAN-to-LAN bridging.

BLACK BOX-DSL PAM offers flexible multiservice and multipoint functionality. BLACK BOX-DSL PAM multiservice modules simultaneously support both interfaces G.703/704 and N\*64 (V.35/36, X.21), providing full multiplexing and cross-connect capability. For example, customer can distribute single G.703 2Mbps stream from CO side into separate FE1 G.704 and N\*64 flows on NTU side for PBX and Router connection.

Multipoint modules provide multiplexing between G.703/G.704 interface and two xDSL loops, including full processing of channel associated signaling (CAS) bits, if it is necessary. This functionality allows splitting single G.703 2Mbps stream from CO side in two separate flows and transmitting toward different NTU sides.

BLACK BOX-DSL PAM series also includes repeater for extension of data transmission length. BLACK BOX-DSL PAM repeaters also support add-drop functionality of 64kbps time slots of E1 stream that allows extract a part of time slots of E1 stream via G.703/G.704 interface at the regenerator points.

## **BLACK BOX-DSL PAM New Generation modems - test and management**

BLACK BOX-DSL PAM New Generation modems and repeaters have full set of performance diagnostics and self test options. All the configurations can be made from the local VT100 emulating terminal or remotely via DSL link or Centralized Network Management System.

Ethernet interfaced modems oriented for LAN and Internet use can be remotely configured through the network via unique IP address of each device.

TDM (G.703 and N\*64) based plug-in units can be configured from the single VT100 configuration port placed on a front or rear panel of the sub rack. Minirack, stand-alone units and repeaters can be reached from LTU side via DSL links. Remote sub-racks can be reached via any 2Mbps TDM network using one 64k TS for management information. For such application BLACK BOX-DSL 4XE module in sub rack is necessary. SNMP network management is provided with CMU module also installable into the sub rack. Standard MIB file can be used for integration into any existing Management Platform. Complete Management solutions based on HP OpenView or CastleRock platforms are available on request.

## **BLACK BOX-DSL PAM New Generation modems - mechanics and power, environmental conditions**

All BLACK BOX-DSL PAM modems are available in plug-in, minirack or stand alone versions. Repeaters are available in stand-alone, IP67 and underground mountable fully isolated stainless steel versions.

All the modules as well as sub rack can be powered from CO batteries with 48/60VDC. Miniracks and stand-alone modules can be also powered from 220VAC (via power adapter for stand alone version).

NTUs and repeaters can be also powered remotely via DSL line from LTU.

All the modems and repeaters are produced according to the standards for indoor use. Repeaters can be delivered with a special environmental protection including temperature range down to -20C and underground mountable fully isolated stainless steel housing.

### BLACK BOX-DSL PAM New Generation modems - ordering information

The list of available BLACK BOX-DSL PAM modules:

MDS921AE-E1	BLACK BOX-DSL modem, stand alone, 1*xDSL (G.SHDSL), NTU, M/S, (REMO), 1*E1 120Ohm (G.703), (PRA), Local/Remote Power
MDS923AE	BLACK BOX-DSL modem, stand alone, 1*xDSL (G.SHDSL), NTU, M/S, (REMO), 1*N64 (V.35/V.36/X.21/EIA-232/EIA-485), Local/Remote Power
MDS923AE-V35X21	BLACK BOX-DSL modem, stand alone, 1*xDSL (G.SHDSL), NTU, M/S, (REMO), 1*E1 120Ohm (G.703), (PRA), 1*N64 (V.35/V.36/X.21/EIA-232/EIA-485), multiservice, Local/Remote Power
MDS920C-2E1	BLACK BOX-DSL module, subrack, 2*xDSL (G.SHDSL), (2-pair), LTU, M/S, (REMO), 2*E1 120 Ohm (G.703), (PRA),
MDS923C-V35X21	BLACK BOX-DSL module, subrack, 1*xDSL (G.SHDSL), LTU, 1*V.35, 1*E1 120Ohm (G.703)
DCE35-0005	V.35 DCE cable DB25M to M34F (Winchester), 1.5m
DTE35-0005	V.35 DTE cable DB25M to M34M (Winchester), 1.5m
DCE36-0005	V.36 DCE cable DB25M to DB37F, 1.5m
DTE36-0005	V.36 DTE cable DB25M to DB37M, 1.5m
DCE21-0005	X.21 DCE cable DB25M to DB15F, 1.5m
DTE21-0005	X.21 DTE cable DB25M to DB15M, 1.5m

Note: Models with E1 75 Ohm interfaces are also available.

# 1 LTU Front Panel Description

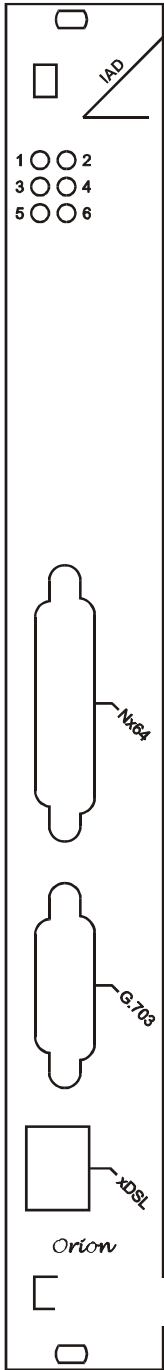

- 1: Tricolour LED for local status channel 1
- 2: Tricolour LED for remote status channel 1
- 3: Tricolour LED for local status channel 2
- 4: Tricolour LED for remote status channel 2
- 5: Tricolour LED for extension card status 1
- 6: Tricolour LED for extension card status 2

Nx64 Sub-D25 female Connector

E1 120 Ω Sub-D15 male Connector

xDSL RJ-45 8 pin Connector

Figure 1-1: Sub rack Front Panel (E1 120 Ω)

**MDS923C-V35X21**

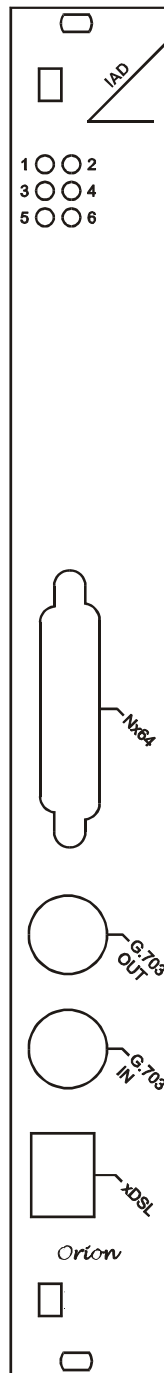

- 1: Tricolour LED for local status channel 1
- 2: Tricolour LED for remote status channel 1
- 3: Tricolour LED for local status channel 2
- 4: Tricolour LED for remote status channel 2
- 5: Tricolour LED for extension card status 1
- 6: Tricolour LED for extension card status 2

N64 Sub-D25 female Connector

E1 75  $\Omega$  BNC Connectors

xDSL RJ-45 8 pin Connector

Figure 1-2: Sub rack Front Panel (E1 75  $\Omega$ )

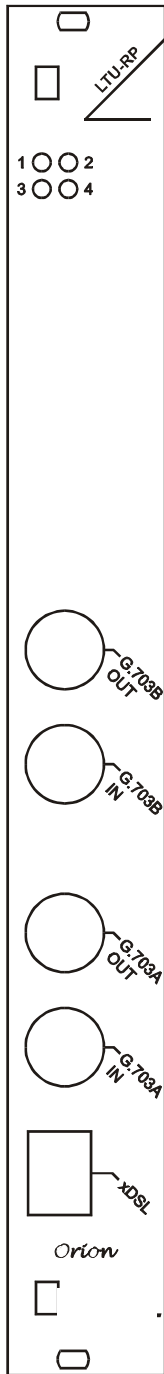

- 1: Tricolour LED for local status channel 1
- 2: Tricolour LED for remote status channel 1
- 3: Tricolour LED for local status channel 2
- 4: Tricolour LED for remote status channel 2

E1 75  $\Omega$  BNC Connectors

E1 75  $\Omega$  BNC Connectors

xDSL RJ-45 8 pin Connector

**Figure 1-3: Dual Sub rack Front Panel (E1 75  $\Omega$ )**

## 2 NTU and Repeater Panel Description

---

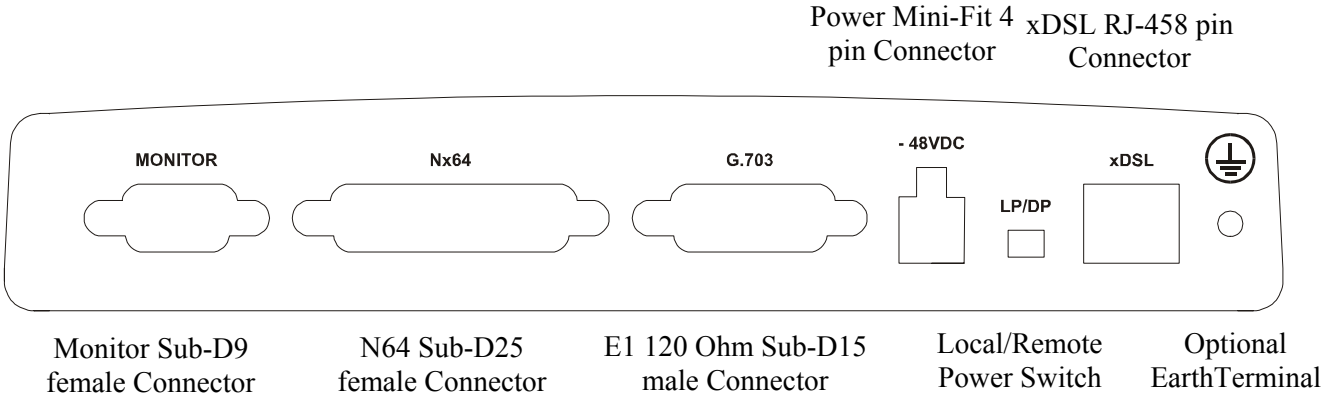

**Figure 2-1: NTU and Repeater Tabletop Rear Panel**

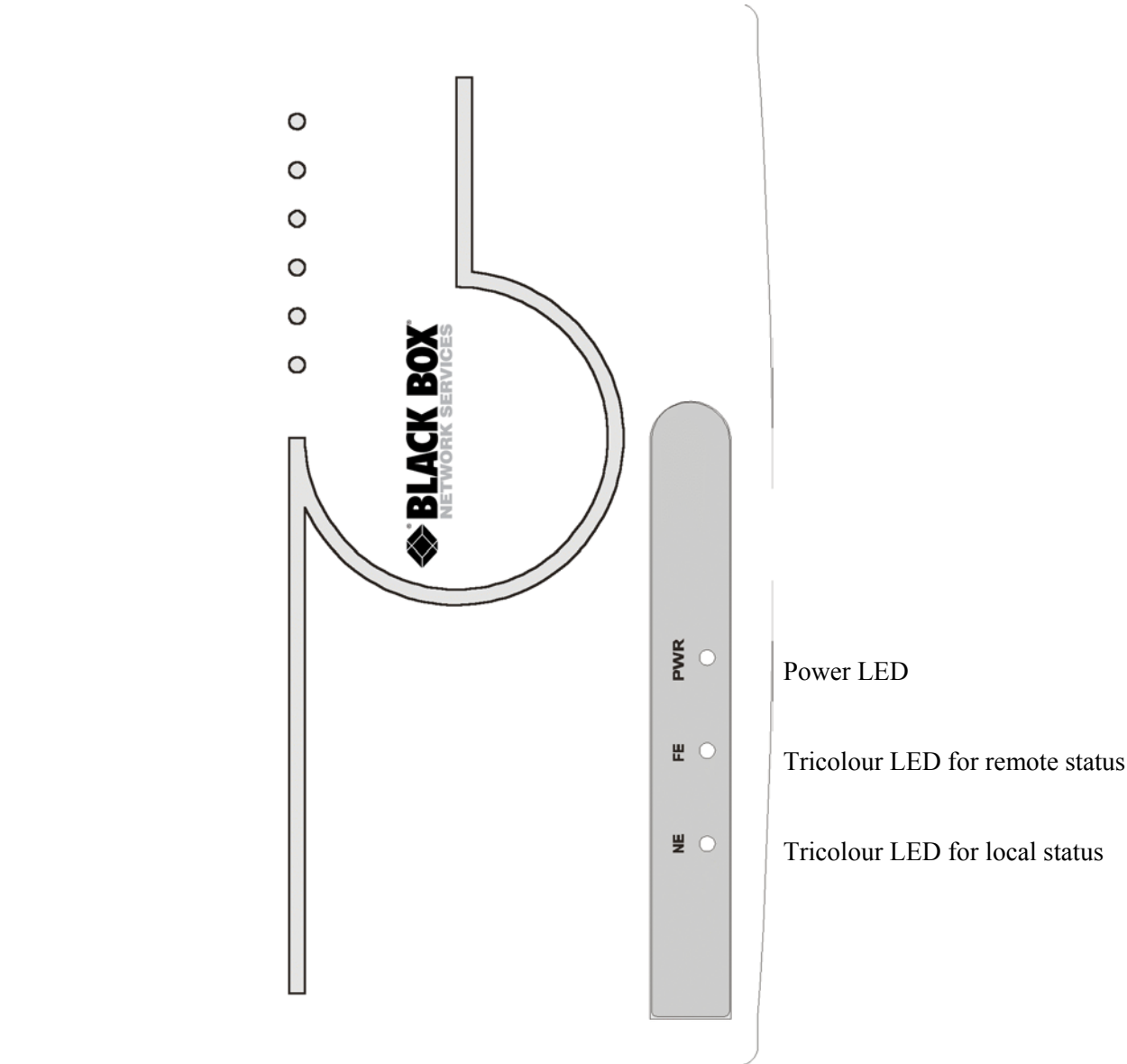

Figure 2-2: NTU and Repeater Tabletop Up View



## 3 Configuration Options

---

The following sections describe the various configuration options. The operating modes for the LTU are configurable via the V.24 monitor interface on the backplane or via the TMN. The only hardware settings on the LTU board are for the wetting current and remote power described later.

The operating modes for the NTU and Repeater are configurable via the V.24 monitor interface on the rear panel as well as from remote LTU (or NTU) via DSL in case of establishing of the link. NTU and Repeater have to be configured for local or remote power switch, placed on the rear panel.

### 3.1 xDSL

The following two configuration options refer to the xDSL side only and do not affect the E1 and Nx64 interface operating mode.

#### 3.1.1 Master / Slave

To start up a xDSL link, one system unit must be configured as master and the other one as slave, as the link start-up procedure is controlled by the slave. If both system units are configured as master or both as slave, no start-up will occur.

Normally, the LTU is configured as master (default setting). In addition, it is also possible to set up a xDSL link with two LTUs, given that one is configured as master and the other one as slave. In an LTU - LTU connection, at least one of the units must be configured as master. It should be noted that if a xDSL link is set up with two LTUs, the "External Clock" option is possible on only one sub-rack side. Also no wetting current is possible in an LTU - LTU connection.

The "Master / Slave" option also affects the EOC related functions.

Generally, the master-slave rights are:

- The master unit has local access as well as access to the slave unit. Only the master / slave and the auto restart configuration cannot be altered by the master unit over the xDSL link for safety reasons.

LTUs are always delivered as master (factory setting).

NTUs are always delivered as slave (factory setting).

The slave unit has the far end LED always off, whereas the master unit has it always on.

### 3.1.2 Repeater xDSL interfaces

xDSL Repeater has two xDSL interfaces: Network (N-side) xDSL interface (operates in slave mode) and Customer (C-side) xDSL interface (operates in master mode). N-side interface operates toward CO side while C-side transceiver works toward CP side. Is there one or more repeaters in the xDSL link, their C-side and N-side interfaces must be connected by appreciated method. Otherwise start-up might occur only for several segments of the link.

#### 3.1.2.1 N-side xDSL interface operating modes

N-side xDSL interface operates only in rate adaptation mode. I.e. it adjusts its line rate according CO (if the repeater is the first in the link) or neighbor C-side xDSL interface base rate setting. If opposite xDSL interface is in rate adaptation mode the system optimizes the bandwidth of this connection by adjusting the base rate value to the maximum where it is possible to get a stable connection.

#### 3.1.2.2 C-side xDSL interface operating modes

C-side xDSL interface can operate in rate adaptation or fixed rate mode. In fixed rate mode the system will start-up the link according base rate setting. In rate adaptation mode the system optimizes the bandwidth of the connection by adjusting the base rate value to the maximum where it is possible to get a stable connection.

### 3.1.3 Normal/Dual pair mode

Units with two xDSL interfaces can operate in 2-wire (Normal) or 4-wire (Dual Pair) mode according to ITU-T G.992.1. To start up a xDSL link, both system units must be set to the same mode. Rate adaptation does not supported in Dual Pair Mode, so in this mode both system units must be set to the same base rate.

## 3.2 E1-Interface (2 Mbit/s G.703 / G.704)

The following configuration options refer to the E1 side only and do not affect the xDSL operating mode.

### 3.2.1 Framing

#### 3.2.1.1 Transparent Mode

In the transparent mode, the E1 data will be transmitted without any changes, whereas in the framed mode the frame / multiframe alignment words and eventually the CRC4 bits are searched for by the E1 framer.

The “CRC4DET“ and “CRC4GEN” option is not relevant in the transparent mode.

Transparent mode does not supported in Multiservice mode and for ADD-DROP Repeaters.

### 3.2.1.2 Framed Mode ITU-T G.704

In the framed mode (framing according to ITU-T Rec. G.704), the incoming E1 data stream passes through an E1 framer before entering the xDSL section. On the other side, the E1 data stream received from the xDSL section first passes through the E1 framer before being transmitted to the E1 network.

The E1 framer operates in the CCS mode. Time slot 16 is fully transparent (except Multipoint PCM30 mode).

Consider the “CRC4DET” and “CRC4GEN” option when operating in the framed mode.

### 3.2.2 CRC4DET Option

If operating in the framed mode, the “CRC4DET” option can be used to adapt the LTU to specific E1 network requirements:

- If enabled, the E1 framer will synchronize on CRC4 multiframes and CRC4 errors will be reported.
- If disabled, the E1 framer will synchronize on basic frames only and no CRC4 errors will be reported. For STU SW versions before 1.6.5.4 in this mode time slot 0 is regenerated toward E1 side (A-Bit is set to 0 and the national bits (Sa-Bits) are set to 1), while for STU SW versions 1.6.5.4 and later in this mode time slot 0 is fully transparent.

### 3.2.3 CRC4GEN Option

If operating in the framed mode and “CRC4DET” option is enabled, the “CRC4GEN” option can be used to adapt the LTU to specific E1 network requirements:

- If enabled, the E1 framer regenerates the CRC4 multiframe alignment and checksum words in the outgoing E1 signal. The A-Bit is set to 0 and the national bits (Sa-Bits) are set to 1.
- If disabled, time slot 0 passes transparently in the outgoing E1 signal, i.e. the A-Bit and all national bits (Sa-Bits) are fully transparent.

### 3.2.4 E-bit Insertion

If operating in the framed mode and “CRC4GEN” option is enabled, the “EBIT” option can be used to adapt the LTU to specific E1 network requirements:

- If the automatic E-Bit generation is enabled, detected CRC4 errors will cause the assertion of the E-bits.
- If disabled, all the E-Bits are set to ‘1’.

The E-bit insertion option is not relevant in transparent mode or if “CRC4GEN” is disabled.

### 3.2.5 AIS Generation

If this option is enabled, an unframed AIS (all 1's) will be transmitted on the E1 side, irrespective of whether the system is configured in the transparent or framed mode. AIS generation will be activated on the following conditions:

- xDSL link to the remote station is not established (loss of signal or loss of frame alignment on xDSL side) or
- remote station is sending AIS or
- AIS-R alarm is active

If "AIS Generation" is disabled, no signal will be transmitted on the E1 side if any of these three conditions occurs.

### 3.2.6 AIS Detection

If "AIS Detection" is enabled, receiving AIS from the E1 side will cause the following actions:

- The Non-Urgent alarm will be set active (AIS-S).
- AIS will be transmitted to the remote station by AIS-R.

### 3.2.7 Transmission of TS16

In Normal and Dual Pair Modes E1 data is loaded to xDSL according ITU-T G.991.2. In these modes TS0 of E1 is mapped to TS0 of xDSL, TS1 to TS1 and etc. In this case it is impossible to transmit TS16 if line rate is lower than 17x64+8 kbps.

For transmission of TS16 when it is necessary to carry signaling bits the special mode (E1-TS16) exist. In this case TS16 is transmitted in the last available xDSL slot.

This special mode supported by multiservice and multipoint units only.

### 3.2.8 E1 - Clock Modes

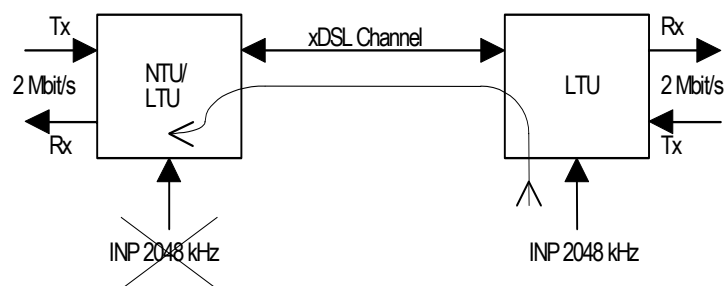

**Figure 3-1: External Clock Mode**

In "External Clock" mode, the 2048 kHz input clock coming from a clock input card via the backplane to the LTU is used as the E1 reference clock. As the xDSL transceivers

operate at a maximum clock frequency of 2064 kHz, the 2048 kHz clock is not used physically to drive the xDSL transmit clock. Data rate adaptation between the 2048 kHz clock and the xDSL transmit clock is achieved by stuffing / deleting bits in the xDSL frames.

Note: Signals towards the XVR section are always TX and signals coming from the XVR sections are always RX.

The following block diagram shows the possible clock sources on the LTU. Note that the clock sources are intended to be references only and do not drive the HDSL transmit section physically. The E1 interface clock is never affected by the crystal controlled HDSL clock.

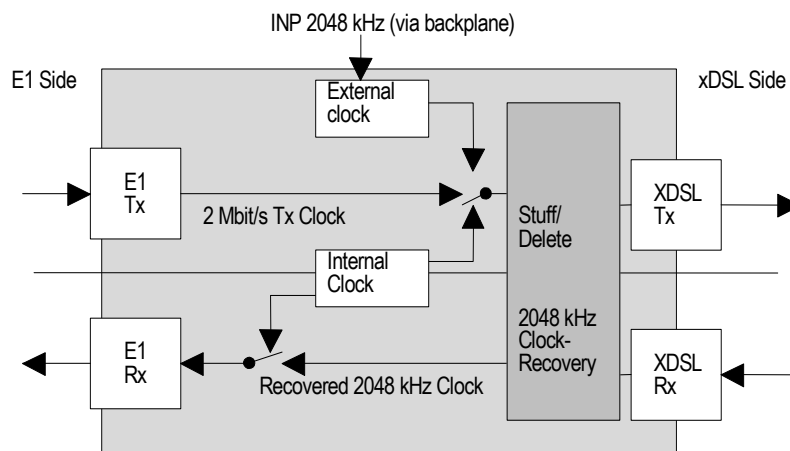

**Figure 3-2: Clock Sources**

If the "External Clock" option is enabled, the primary E1 clock source is the external clock. If no external clock is present at the 2048 kHz clock input, the E1 transmit clock is used as the clock source (on the master side only). If no signal is received at the E1 port, then the internal clock is used as the clock source.

If the "External Clock" option is disabled, the primary E1 clock source is the 2 Mbit/s transmit clock. If no signal is received at the E1 port, then the internal clock is used as the clock source.

The external clock is never used to drive the E1 RX direction.

As long as the xDSL link is not established, the internal clock oscillator is used as the clock source.

The clock sources are automatically switched by the micro controller, depending on the actual signal and clock status, which is updated every 100 ms.

### 3.2.9 Synchronous and plesiochronous operation

Both synchronous and plesiochronous operation modes are possible.

Synchronous operation occurs, when the E1 equipment at one end of the xDSL link uses the receive clock as transmit clock, as shown below. In this case receive PLL in master modem XVR is disabled.

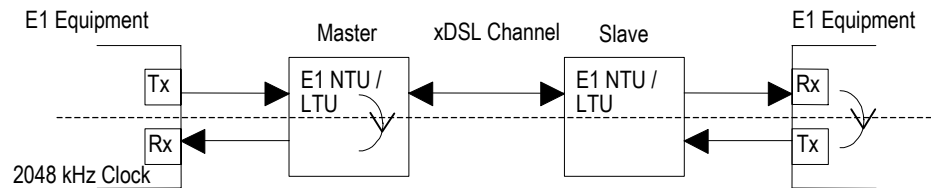

**Figure 3-3: Synchronous Operation**

Plesiochronous operation occurs, when the E1 equipment at both ends of the xDSL link has its own clock generator, as shown below. In this case receive PLL in master XVR should be enabled.

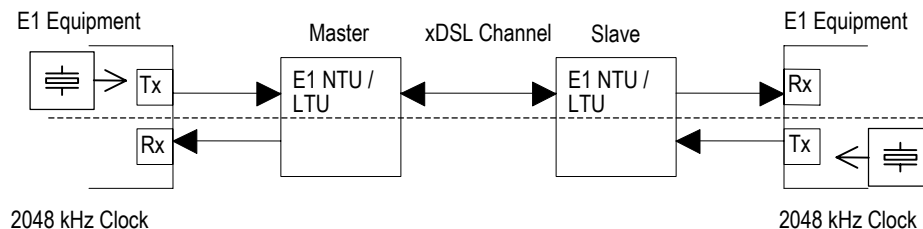

**Figure 3-4: Plesiochronous Operation**

**Warning:** Do not configure the E1 interfaces at both ends to use the receive clock as transmit clock except if one xDSL equipment is an LTU using the "External Clock" option. Otherwise there will be no defined clock.

## 3.3 Nx64 Interface (DCE)

The following configuration options refer to the Nx64 (V.35/V.36/X.21 – SW configurable) side only and do not affect the xDSL operating mode.

### 3.3.1 Nx64 Services

One can choose between three available services:

- E1 only: With this service mode, the Nx64 interface is shut down. No payload data is transferred to/from Nx64 transceiver.
- Nx64 only: With this service mode, the E1 transceiver is shut down or is sending AIS. No payload data is transferred to/from E1 transceiver.
- Multiservice Nx64 & fE1: With this service mode, the available xDSL payload is divided into Nx64 payload and E1 payload. The Nx64 payload always starts at

22 of 79

timeslot 1 upwards, skipping timeslot 16 up to timeslot 31, then using timeslot 16 and at last timeslot 0. The E1 payload follows after the last used Nx64 timeslot.

### 3.3.2 Nx64 Clock Directions

There are two options available:

- co directional: Transmit clock and data have same directions, i.e. both are inputs to the DCE at signal number 113 and 115.
- contra directional: Transmit clock and data have opposite directions, i.e. transmit clock is output from the DCE at signal number 114 and transmit data is input to the DCE at signal number 115.

### 3.3.3 Nx64 Clock Modes

The following table shows different combinations of clock modes, some of which are invalid. There are three possible DCE clock modes:

- from E1: This clock mode is active when the E1 interface is active.
- external: In this clock mode, the DCE is clock slave and has its PLL on the transmit side (from Nx64 to the xDSL interface) is on.
- internal: In this clock mode, the DCE is clock master and the PLL is off, generating a 2048 kHz clock from the internal oscillator directly.

Service	DTE Clock Mode	DCE Clock Mode	DCE Clock Direction	xDSL Clock Mode
Nx64 only	Slave	internal	don't care	Master
	Slave	external	don't care	Slave
	Master	external	codirectional	Master
	<del>Master</del>	<del>external</del>	<del>contradirectional</del>	<del>Master</del>
	<del>Master</del>	<del>don't care</del>	<del>don't care</del>	<del>Slave</del>
Nx64 & fE1	Slave	from E1	don't care	Master
	Slave	from E1	don't care	Slave
	<del>Master</del>	<del>don't care</del>	<del>don't care</del>	<del>don't care</del>

Note: Invalid clock modes are ruled out.

### 3.3.4 Nx64 Block Diagram

The following block diagram shows the receive and transmit path separately. Each direction possesses a FIFO buffer and a PLL.

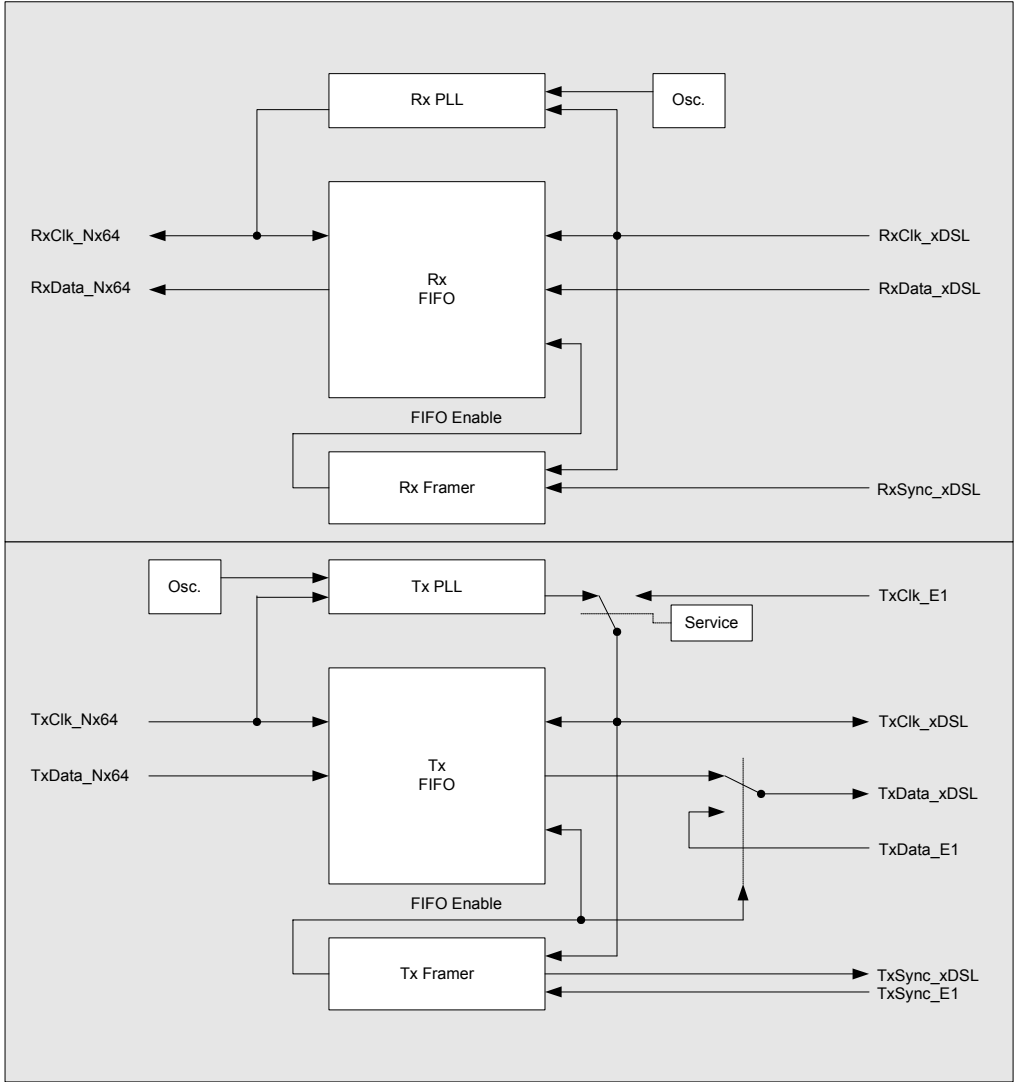
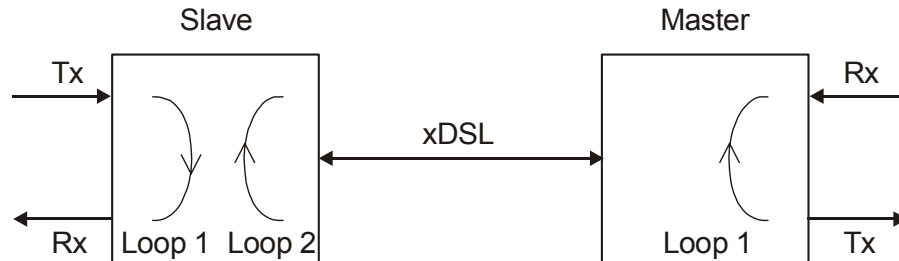

Figure 3-5: Nx64 Block Diagram



### 3.3.5 Automatic V.54 loops

System supports V.54 loops, managed by 140-142 lines. Supporting of V.54 loops is SW programmable.



State Name	Master			Slave				State Description
	RL	LL	TI	RL	LL	TI	DSR	
Normal	1	1	1	1	1	1	0	Data Transmission
Loop1 at Master Side (Setting by terminal command)	1	1	0	1	1	1	0	TX Data is looped back to RX at Nx64 Master Network Interface. LOOP1 alarm is active on Master side.
Loop2 (Setting by terminal command)	1	1	0	1	1	0	1	Data from DSL is looped back towards Master side in Slave DSP (Core loopback). LOOP2 alarm is active on Master and Slave sides.
Loop1 at Slave Side (Setting by terminal command)	1	1	1	1	1	0	0	TX Data is looped back to RX at Nx64 Slave Network Interface. LOOP1 alarm is active on Slave side.
Automatic Loop1 setting at Master side (activated by LL line on Master interface)	1	0	0	1	1	1	0	TX Data is looped back to RX at Nx64 Master Network Interface. LOOP1 alarm is active on Master side
Automatic Loop2 (activated by RL line on Master interface)	0	1	0	1	1	0	1	Data from DSL is looped back towards Master side in Slave DSP (Core loopback). LOOP2 alarm is active on Master and Slave sides.
Automatic Loop1 setting at Slave side (activated by LL line on Slave interface)	1	1	1	1	0	0	0	TX Data is looped back to RX at Nx64 Slave Network Interface. LOOP1 alarm is active on Slave side.

### 3.4 Multipoint Operation

In Multipoint mode E1 data is multiplexed to two xDSL interfaces. First n channel time slots is transmitted through xDSL interface A, while other m channel slots – via xDSL interface B. There are two sub-modes: PCM30, when TS16 is processed as signaling slot, and PCM31, when TS16 is considered as channel slot.

**Example1:**

PAYLOAD 10 14

PCM 30

BASERATE 20 22

Timeslots exchange table:

DSL interface A	DSL interface B	G.703 interface
0 (see CRC4GEN)	0 (see CRC4GEN)	0 (see CRC4GEN)
1 – 10	-	1 - 10
-	1 - 5	11 – 15
-	6 - 14	17 – 25
16 (see PCM)	16 (see PCM)	16 (see PCM)
11 – 15, 17 – 19	15, 17 – 22	26 – 31
IDLE	IDLE	IDLE

**Example2:**

PAYLOAD 10 14

PCM 31

BASERATE 11 15

Timeslots exchange table:

DSL interface A	DSL interface B	G.703 interface
0 (see CRC4GEN)	0 (see CRC4GEN)	0 (see CRC4GEN)
1 – 10	-	1 - 10
-	1 – 14	11 – 24

### 3.5 ADD-DROP Operation

In ADD-DROP Repeaters data from N-side xDSL interface is multiplexed to E1 and C-side xDSL interface. First n channel time slots are transmitted through C-side xDSL interface, while other m channel slots – via E1 interface. There are two sub-modes: PCM30, when TS16 is processed as signaling slot, and PCM31, when TS16 is considered as channel slot.

Time slot 0 from N-side xDSL interface is transmitted transparently toward C-side xDSL and E1 interfaces. Transmission of time slot 0 toward N-side xDSL interface is SW programmable.

**Example1:**

PAYLOAD : 10 14

PCM Mode : 30

BASERATE : 17

TS0 Source : DSL C side

Timeslots exchange table:

C-side xDSL interface	G.703 interface	N-side xDSL interface
0 – to CP: from N-side 0 – to N-side: from DSL	0 – to E1 (see CRC4GEN)	0 – to CO: from C-side
1 – 10	-	1 – 10
-	1 – 5	11 – 15
-	6 – 14	17 – 25
16 (see PCM)	16 (see PCM)	16 (see PCM)
11 – 15, 17 – 19 IDLE	15, 17 – 22 IDLE	26 – 31 IDLE

**Example2:**

PAYLOAD : 10 14

PCM Mode : 31

BASERATE : 11

TS0 Source : E1

Timeslots exchange table:

C-side xDSL interface	G.703 interface	N-side xDSL interface
0 – to CP: from N-side 0 – to N-side: from DSL	0 – to E1 (see CRC4GEN)	0 – to CO: from E1
1 – 10	-	1 – 10
-	1 – 14	11 – 24

## 3.6 Test Loops

### 3.6.1 Standard Test Loops

The test loops can be activated via the monitor interface.

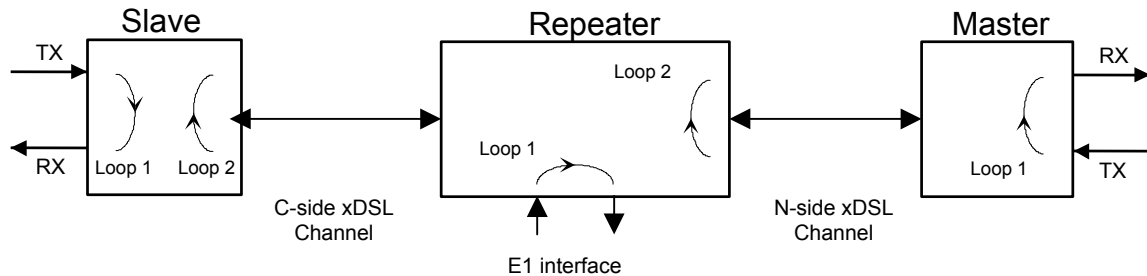

**Figure 3-6: standard Test Loops**

Note:

On the slave side, Loop 1 can only be activated locally; Loop 2 can only be activated remotely by the master.

Both the NE LED on the slave and the FE LED on the master will be lit amber when Loop2 is active.

At the regenerator point Loop2 and Loop1 can be activated locally or remotely by the master.

Both the NE LED on the regenerator and the FE LED on the master will be lit amber when Loop2 is active.

On the master side, Loop 1 can only be activated locally, Loop 2 does not exist. The NE LED will be lit amber when Loop 1 is active.

### 3.6.2 Analog Loop Back

To test the BLACK BOX-DSL equipment itself, the Analog Loop Back can be used. To perform this test, the xDSL - cable has to be disconnected from the unit and the test can be activated with the appropriate monitor command (see chapter 'BLACK BOX-DSL Monitor').

During the Analog Test Loop, the xDSL-receiver part receives the transmitted signal of its own transmitter due to the impedance mismatch in the xDSL-line transformer.

All data of the user interface is looped back according the UIF and its settings.

An Analog Loop Back causes a non-urgent alarm.

## 4 Performance Monitoring

The transmission performance of a xDSL link can be monitored in two different ways. The xDSL signal quality is typically used during installation and maintenance procedures, whereas the G.826 error performance parameters are intended to be used for long-term evaluation of operating xDSL links. Refer also to the “SQ” and “G826” monitor commands described in the “BLACK BOX-DSL Monitor” section.

### 4.1 G.826 Performance Monitoring

The G.826 error performance parameters provide *quantitative* performance information of a specific loop. They are intended to be used for long-term evaluation of operating xDSL links.

The evaluation of the G.826 error performance parameters is based on CRC (Cyclic Redundancy Check) error detection:

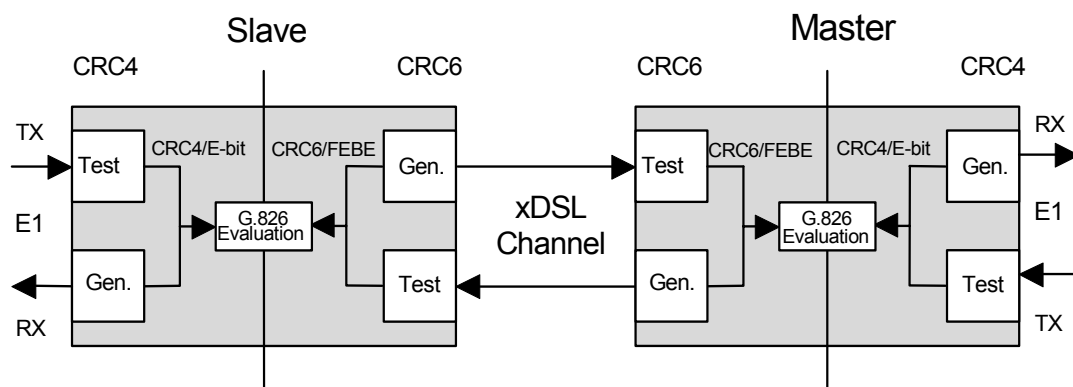

**Figure 4-1: G.826 Performance Evaluation**

CRC generation and detection on the LTU/NTU are handled separately for the E1 side and the xDSL side, while on the ADD-DROP Repeater CRC generation and detection on are handled separately for the E1 side and both xDSL sides.

On the E1 side, four CRC4 check bits are generated per sub-multiframe (SMF) and compared with the corresponding CRC4 bits in the following SMF. If they do not match, the CRC4 error counter is incremented. The opposite station is informed of detected

CRC4 errors by setting E-bits in the transmitted frames. At the same time, the E-Bits from the opposite station are counted and can be used for performance monitoring.

Similarly, on the xDSL side, six CRC6 check bits are generated per xDSL frame for each channel and direction. For signaling detected block-errors in the return direction, the FEBE-bits are used. The HDSL G.826 performance of the opposite unit is calculated according to these FEBE-bits.

CRC6 errors are used by software to count the block-errors of the respective xDSL channel and to evaluate its error performance according to ITU-T Rec. G.826.

For the E1 interface, calculations according to G.826 are only possible in the framed mode with CRC4 option enabled. In framed mode with CRC4 option disabled only FAS-errors are detected.

The estimation of a *bit-error rate* is not within the scope of the G.826 calculations.

## 5 Alarms

---

### 5.1 General

This chapter describes a possible implementation for the alarm signalization.

### 5.2 LEDs

The four LTU LEDs '1: local status channel 1', '2: remote status channel 1', '3: local status channel 2' and '4: remote status channel 2' and the two NTU LEDs 'far end (FE) status' and 'near end (NE) status' are used to display normal operation condition and alarm condition. Each LED can be green, amber or red when lit according to the following table.

Some NTU models and repeaters have third LED for power representation.

ADD-DROP repeater has NE and FE LEDs, which represents normal operation condition and alarm condition. NE LED is responsible for local status of N-side and E1 interfaces, while FE LED is responsible for local status of C-side interface.

#### 5.2.1 Status LEDs LTU/NTU (except Multipoint Mode)

Status	Local (NE) LED	Remote (FE) LED
LTU Power failure	Off	off
Hardware - / Software failure	Blinking	off
Normal operation local	Green	don't care
Normal operation remote	Don't care	green
Minor alarm local	Amber	don't care
Minor alarm remote	Don't care	amber
Major alarm local	Red	don't care
Major alarm remote	Don't care	red

### 5.2.2 Status LEDs LTU/NTU (Multipoint Mode)

Status	Local (NE) LED	Remote (FE) LED
Power failure	Off	off
Hardware - / Software failure	Blinking	off
No EOC connection established	On	red
Normal operation local	Green	don't care
Normal operation remote	Don't care	green
Minor alarm local or one channel major alarm local	Amber	don't care
Minor alarm remote or one channel major alarm remote	Don't care	amber
Both channel major alarm local	Red	don't care
Both channel major alarm remote	Don't care	red

### 5.2.3 Status LEDs ADD\_DROP Repeater

Status	Local (NE) LED	Remote (FE) LED
LTU Power failure	Off	off
Hardware - / Software failure	Blinking	off
Normal operation of E1 or N-side xDSL	Green	don't care
Normal operation of C-side xDSL	Don't care	green
Minor alarm of E1 or N-side xDSL	Amber	don't care
Minor alarm of C-side xDSL	Don't care	amber
Major alarm of E1 or N-side xDSL	Red	don't care
Major alarm of C-side xDSL	Don't care	red



## 5.2.4 Local LED - Alarm Conditions

### 5.2.4.1 Local (NE) LED

An alarm condition is displayed with the Local LED if one of the following conditions occurs:

Major alarm (red):

- Hardware or software failure (blinking)
- loss of signal / frame alignment on the xDSL side
- xDSL block-error-rate according G.826  $\geq$  30% (BER-H)
- E1 block-error-rate according G.826  $\geq$  30% (BER-S)

Minor alarm (amber):

- loss of signal on the E1 side (LOS-S)
- loss of frame alignment on the E1 side (LFA-S)
- Segment defect alarm (SEGD)
- receiving AIS on E1 side (AIS-S)
- either Loop 1, Loop 2 is activated
- Analog Loopback is activated
- Spectrum Transmission activated

Displaying a major alarm has a higher priority than displaying a minor one, i.e. an amber alarm will be “overwritten” by a red alarm.

### 5.2.4.2 Remote (FE) LED

The remote LED is an image of the local LED of the remote station (see previous LED-table for exceptions).

## 5.3 Alarm Relays LTU

### 5.3.1 Implementation

The two alarm relays "Major" and "Minor", are located on the relay card and are "wired-OR" on the backplane to the "open-collector" alarm outputs of the LTUs. Under normal LTU power conditions the two output-stages of each LTU are controlled by its microcontroller. But even in case of a power failure on an LTU, both the "Major" and "Minor" alarms will be activated on the relay card. The backplane generates an auxiliary +5 V<sub>DC</sub> that is used to "pull-up" the "open-collector" alarm outputs stages of the LTUs.

### 5.3.2 Relay - Alarm Conditions

#### Major alarm:

- At least one of the LTU - LEDs displays a red alarm
- Power failure of any one of the LTUs
- Power failure of the auxiliary +5 V<sub>DC</sub> auxiliary supply on the backplane
- Power failure of both the -48 V<sub>DC</sub> supplies

#### Minor alarm:

- At least one of the LTU - LEDs displays an amber alarm and none of the LTU - LEDs displays a red alarm
- Power failure of any one of the LTUs
- Power failure of the auxiliary +5 V<sub>DC</sub> auxiliary supply on the backplane
- Power failure of one of the -48 V<sub>DC</sub> supplies

## 5.4 Alarm Relays NTU and Repeater

### 5.4.1 Implementation

The two alarm relays "Major" and "Minor" are located on the NTU board itself.

### 5.4.2 Relay - Alarm Conditions

#### Major alarm:

- At least one of the NTU LEDs displays a red alarm
- Power failure of the NTUs

#### Minor alarm:

- At least one of the NTU LEDs displays an amber alarm and none - a red alarm
- Power failure of the LTUs

## 6 LTU Power Concept

---

Each LTU is fed via the backplane with (dual)  $-48 V_{DC}$  (referenced to 0 VDC of the exchange battery). The LTU converts these voltages to its onboard supply, the wetting current voltage and remote power voltage (see below).

The ground references of all voltages on the secondary side of the LTU's DC/DC-converter are tied to FPE (Functional Protective Earth). This is done over the backplane as well as over the sub-rack with its LTU front-panels.

Additionally, the LTU is fed over the backplane's DC/DC-converter with an auxiliary  $+5 V_{DC}$  supply (referenced to ground). The only purpose of this voltage is to drive the alarm-circuitry on each LTU, even in the case of a failure of the LTU's onboard DC/DC-converter.

In case of a failure of the LTU's onboard power supply, all LEDs on the front-panel will be extinguished.

### 6.1 Power modes (remote power source on request)

Each channel of dual LTU can be configured as wetting current source or wetting current receipt or remote power source.

#### 6.1.1 Wetting current source

With *wetting current* option LTU sends to the loop low voltage signal to 'wet' the bad contact and this way cure it. Our long term experience in Eastern European markets shows that *wetting current* options can dramatically increase number of pairs usable for DSL installations.

The wetting current is a small current of about 2 – 4 mA, which is sourced by the LTU and sinked by the NTU.

#### 6.1.2 Wetting current receipt

In LTU-LTU application one of LTUs can be also configured as remote power receipt.

#### 6.1.3 2x100V power mode

Allows having one remotely powered NTU or Repeater at each xDSL line. The output remote power voltage is 115VDC.

### 6.1.4 1x200V power mode

Allows having one remotely powered Regenerator and NTU, or two remotely powered Regenerators at xDSL line A. The output remote power voltage is 200VDC.

### 6.1.5 Power jumpers

There are two jumpers J1107 and J1108 for remote power voltage selection and six jumpers J1101 – J1106 (three for each xDSL) on the LTU to select between wetting current source/wetting current receipt and remote power mode.

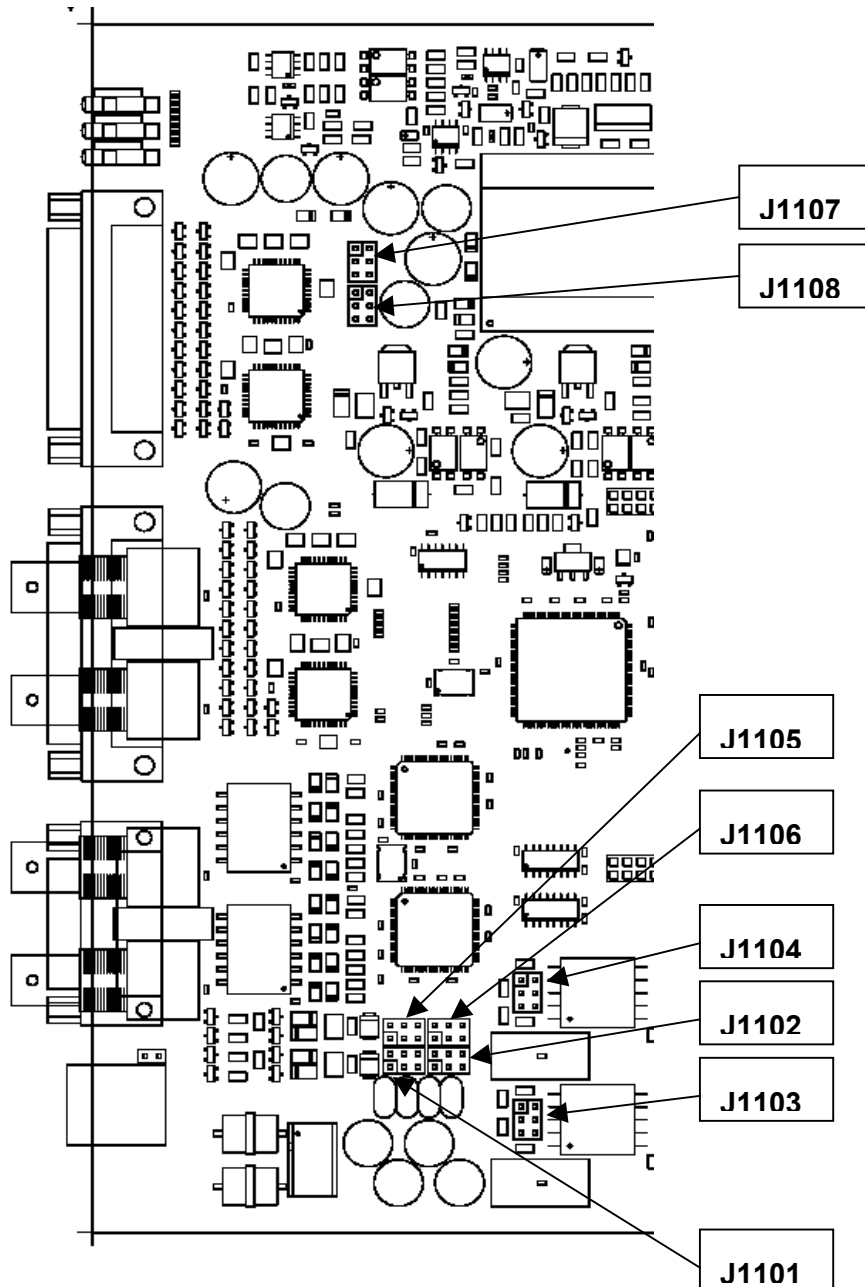

Figure 6-1: LTU current jumper locations

<i>Jumpers</i>	<i>Position</i>	<i>Feature</i>
J1101	closed	Wetting current source for xDSL A enabled
J1102	closed	Wetting current source for xDSL B enabled
J1103	closed	Wetting current receipt for xDSL A enabled
J1104	closed	Wetting current receipt for xDSL B enabled
J1105	closed	Remote power source for xDSL A enabled
J1106	closed	Remote power source for xDSL B enabled
J1107	closed	115 Vdc
J1108	closed	200 Vdc

- ! Important Notes:**
1. Only one of J1107 and J1108 can be closed!
  2. Only one of J1101, J1103 and J1105 can be closed!
  3. Only one of J1102, J1104 and J1106 can be closed!

### 6.1.6 Remote power concept

Remote Feeding mode has the following characteristics:

- Cross-wiring tolerant
- Power feeding voltage within TNV-Limits (max. < 120 V<sub>DC</sub>)
- current limiters micro controller - controlled
- Tolerant against microinterruptions
- Automatic system restart after power failure
- Protection according to ITU-T Rec. K.20

The state-machine of the current limit detector (CL) including timing is shown in the following diagram:

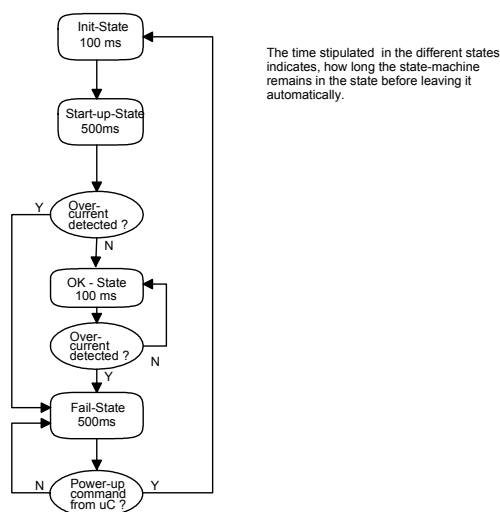

**Figure 6-2: Current Limiter state machine**

The internal sampling rate for the CLDET-Signal is 10ms. The result is integrated with a slope-factor of 4 for the event of CLDET = active and disintegrated with a slope-factor of 1 for the event CLDET = inactive. The result of the integrator is checked every 100 ms.

The remote power feeding is under firmware control and can therefore be controlled by the monitor.

## 6.2 Wetting current (MDS923C-V35X21 and MDS920C-2E1)

The position of the jumpers is described in the following figure.

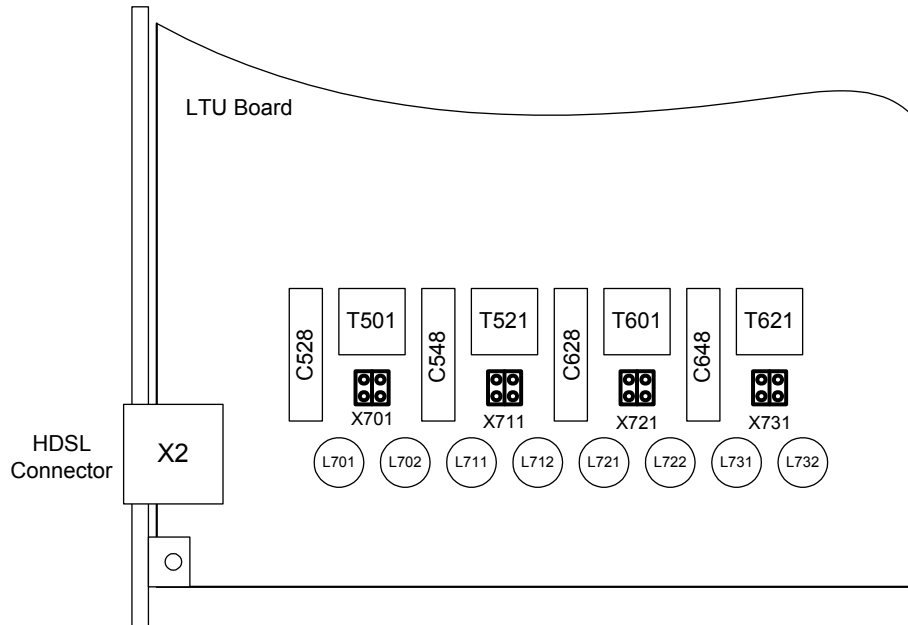

**Figure 6-3: LTU Wetting current jumper locations**

The eight Jumpers X701 – X731 on the LTU are to select the wetting current feature. The feature is enable, when the jumpers are closed.

<i>Jumpers</i>	<i>Position</i>	<i>Feature</i>
X701	closed	Wetting current for RXA/TXA enabled
X711	closed	Wetting current for TXA enabeld
X721	closed	Wetting current for RXB/TXA enabled
X731	closed	Wetting current for TXB enabled

If RX and TX are on separate lines, X701 and X711 have to be closed, in the other case where RX and TX are on the same line only X701 has to be closed. The same rule is valid also for X721 and X731.

The factory settings for the LTU are as follow: The jumpers X701 and X721 are closed.

## 7 NTU Power Concept

Each NTU is fed via the power supply Molex connector on the rear panel with 48 V<sub>DC</sub>. The NTU converts these voltages to its onboard supply with its DC/DC converter.

In case of a failure of the NTU's onboard power supply, all LEDs on the front-panel will be extinguished.

Repeater and NTU, which support remote power, can be powered remotely via xDSL. In case of remote powering wetting current acceptance should be switched off (remove jumpers -see figure below).

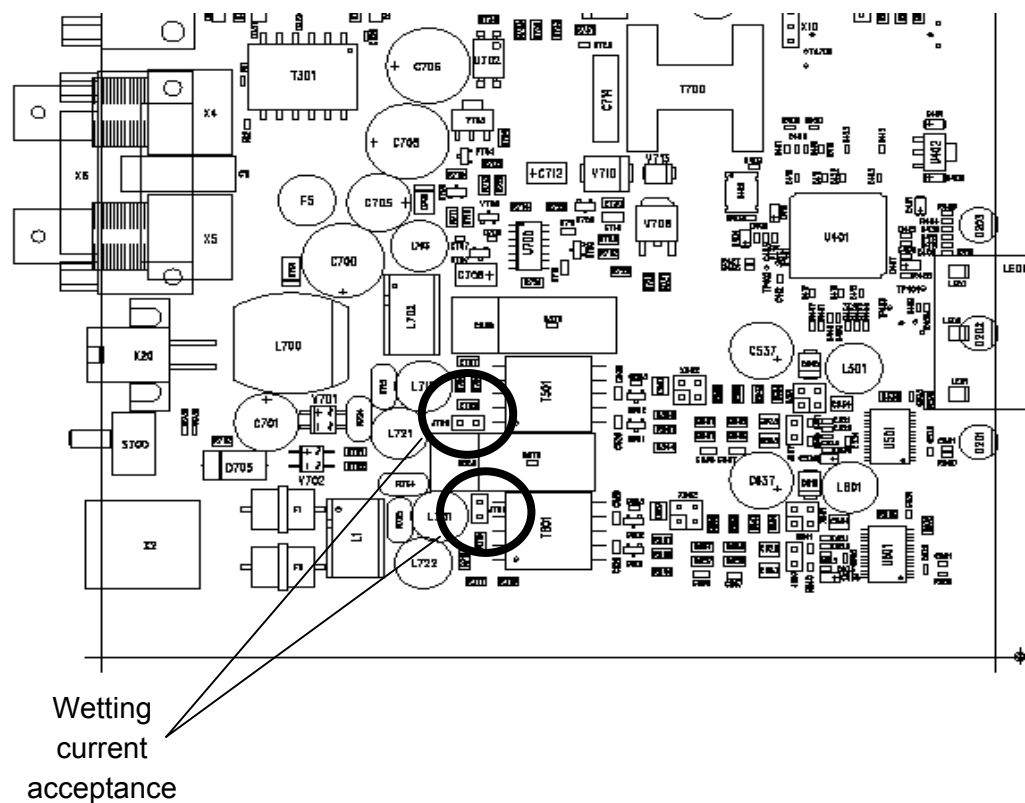

Figure 7-1: NTU Wetting current jumper locations

## 8 Monitor

---

### 8.1 General

The module can be connected to a terminal or a PC (with terminal emulation) in order to monitor relevant events and to display additional information such as the signal quality of the xDSL link or the G.826 error performance parameters. In addition, full system configuration and fault localization can be done over the monitor interface

The terminal for monitoring should be VT100 compatible and configured as follows:

- 9600 baud, asynchronous
- 8 bits, no parity, one stop bit
- no new line on carriage return (i.e. no line feed on carriage return)

### 8.2 Monitor Interface

There is a point / multipoint TTL-bus (9600 baud) on the sub-rack's backplane. The TTL to RS232 level conversion is done on the backplane where the RS232 converter and the monitor connector are located.

At any time only one of the LTUs in the sub-rack can be logically connected to the monitor interface. The appropriate LTU is selected according its physical position in the sub-rack, starting with the leftmost slot number 01 and ascending rightwards to number 14. To select the LTU in slot number *SN*, just type `<%SN>` at the terminal, even in the case it does not show any prompt. (e.g. to select the LTU in slot 01, type `'%01'`). To access the second channel on a dual LTU, add 20 (twenty) to the slot number or access it over the main menu screen of the first channel.

To see which units in a rack are available, you can use the `<ECHO>` command. Each present unit will respond with its associated slot number (`%SN`).

The response could be: `%01 %03 %08 %10 %11 %12`

Note: Each command must be terminated by a carriage return.

Please note that if the auxiliary +5 V<sub>DC</sub> power supply on the backplane fails (indicated by an extinguished +5V LED on the backplane), the monitor function will cease to function but the transmission facilities of the LTUs are still fully guaranteed.

The NTU and Repeater can be connected to terminal or PC directly.



### 8.3 Structure & Organization

The structure and organization of the BLACK BOX-DSL monitor is adapted to ITU-T Recommendation M.3400 for TMNs with its five sub-sets.

Sub-set	Short-form
Performance management	PM
Fault and maintenance management	FMM
Configuration management	CM
Accounting management	AM
Security management	SM

As BLACK BOX-DSL does not support Accounting management nor Security management, AM and SM are not in the monitor's main menu.

At any time, the <H> ("Help") command shows and explains the available commands and their parameters.

The prompt on the screen consists of:

- a master/slave or repeater (CO - central office, CP - customer premise, RR - repeater) indication
- the slot-number <SN> indication or the repeater address indication
- the short form of the specified sub-set menu.

For example: "CO\_04\_FMM>".

"RR\_04\_FMM>".

Note: Repeater address is calculated as repeater position (starting from CO side) in the xDSL chain plus 2. Thus the repeater nearest to CO side has address 03, second one – 04, etc.

LTU/NTU command set tree for Normal and Dual modes.

Main Menu		
Performance	Fault and Maintenance	Configuration
G826	SQ	CONFIG
G826 C	STARTUP	G704
G826 E1	STATUS	CRC4DET
G826 E1 C	ALARM	CRC4GEN
RESETG826	ALARM T	EBIT
	LOOP1	AISGEN
	LOOP2	AISDET
	STARTAL	EXTCLK
	RESTART	SERVICE
	RESET	TYPE
	SPECTRUM	BITRATE
		CLOCKMODE
		CLOCKDIR
		SLOTUSAGE
		AUTOLOOP
		MODE
		MASTER
		PLL
		POWER
		ID
		AUTORESTART
		BASERATE
		DEFAULT
		ADAPTIVE

Figure 8-1: LTU/NTU Monitor Command Set Tree (Normal/Dual Pair Modes)

LTU/NTU command set tree for Multipoint mode.

Main Menu		
Performance	Fault and Maintenance	Configuration
G826	SQ	CONFIG
G826 C	STARTUP	CRC4DET
G826 E1	STATUS	CRC4GEN
G826 E1 C	ALARM	EBIT
RESETG826	ALARM T	AISGEN
	LOOP1	AISDET
	LOOP2	EXTCLK
	STARTAL	IDLECAS
	RESTART	PCM
	RESET	PAYLOAD
	SPECTRUM	MODE
		POWER
		ID
		AUTORESTART
		BASERATE
		DEFAULT
		ADAPTIVE

Figure 8-2: LTU/NTU Monitor Command Set Tree (Multipoint Mode)

The repeater command set tree is shown below:

Main Menu		
Performance	Fault and Maintenance	Configuration
G826	SQ	CONFIG
G826 C	STARTUP	CRC4DET
G826 E1	STATUS	CRC4GEN
G826 E1 C	ALARM	EBIT
RESETG826	ALARM T	AISGEN
	LOOP1	AISDET
	LOOP2	IDLECAS
	STARTAL	PCM
	RESTART	PAYLOAD
	RESET	TS0SRC
	SPECTRUM	AUTORESTART
		BASERATE
		ADAPTIVE
		ID

**Figure 8-3: ADD-DROP Repeater Monitor Command Set Tree**

## 8.3.1 Main Menu

```
BLACK BOX-DSL Sub rack Dual E1
ID: UNIT#1
HW Rev. B0
SW Rev. 1.6.4.0
FW Rev. R1.7
```

Copyright (C) 2002 by BLACK BOX Network Services AG

```
----- Main Menu -----
1. Performance management (PM)
2. Fault and maintenance management (FMM)
3. Configuration management (CM)
4. Select next channel
5. Exit
-----
```

```
CO_01_MM>Select [1..5]:
```

To select the sub-menus type 1 to 5.

Note: Each command must be terminated by a carriage return.

## 8.3.2 Common Commands

Common commands are available in every sub menu.

### 8.3.2.1 HELP Command

By typing the letter "H" followed by [ENTER], all available commands of the actual sub menu are displayed.

### 8.3.2.2 MAIN Command

By typing the letter "M" followed by [ENTER], you return to the Main Menu Screen.

### 8.3.2.3 CONNECT Command

The CONNECT command opens a virtual terminal connection to the remote unit, i.e. characters received at the local unit's V.24 interface are sent to the remote unit, and characters (screen messages) sent from the remote unit are transmitted back to the local unit's V.24 interface.

During a virtual terminal session, the local unit is not available any more, unless you close your virtual terminal connection by typing the DISCONNECT command or by selecting "Exit" on the Main Menu Screen (of the remote unit).

Some commands will be unavailable from a virtual terminal connection for safety reasons.

Add the parameter “R” to connect to the remote unit (i.e. LTU or NTU) or type the repeater number (1 to 8) instead of “R” to connect to the selected repeater (this is only possible from master side).

### 8.3.2.4 DISCONNECT Command

The DISCONNECT command closes the virtual terminal connection to the remote unit.

## 8.3.3 Performance management PM

Performance management activated  
Enter <M> to return to MAIN, or <H> for HELP information

Type <H> and the monitor lists all available commands in the performance sub-menu.

### 8.3.3.1 G826 Command

The G826 command displays the ITU-T G.826 error performance on xDSL line side:

```
CO_01_PM> G826
```

G.826 Error Performance	CRC6	FEBE
Errored blocks	00000000	00000000
Errored seconds	00000000	00000000
Severely errored seconds	00000000	00000000
Background block errors	00000000	00000000
Available time	00624483	00624483
Unavailable time	00000024	00000024

```
CO_01_PM>
```

#### Option:

- C Updates the G.826 parameters continuously

#### Definitions:

1. CRC6: Cyclic redundancy check indicating errored blocks received on the local xDSL side.
2. FEBE: Far end block error indicating errored blocks received on the remote xDSL side.
3. Errored block (EB): A block in which one or more bits are in error.
4. Errored seconds (ES): A one second period with one or more errored blocks. SES defined below is a subset of ES.
5. Severely errored second (SES): A one second period which contains  $\geq 30\%$  errored blocks.
6. Background block error (BBE): An errored block not occurring as part of an SES.

Note: Repeater and units in Multipoint and Dual Pair modes represent data for both xDSL interfaces.

### 8.3.3.2 G826 E1 Command

The G826 E1 command displays the ITU-T G.826 error performance parameters on the E1 2Mbit/s side. This command is only available if framed mode is enabled.

If CRC4 mode is on, the following parameters are displayed:

```
CO_01_PM> G826 E1
-----
G.826 Error Performance :   CRC4       E-Bit
-----
Errored Blocks          : 00000000 00000000
Errored seconds         : 00000000 00000000
Severely errored seconds : 00000000 00000000
Background block errors : 00000000 00000000
Available time          : 00524129 00524129
Unavailable time        : 00000024 00000024
-----
CO_01_PM>
```

If CRC4 detection mode is off, the following parameters are displayed:

```
CO_01_PM> G826 E1
-----
G.826 Error Performance :   FAS
-----
Errored blocks          : 00000000
Errored seconds         : 00000000
Severely errored seconds : 00000000
Background block errors : 00000000
Available time          : 00009841
Unavailable time        : 00000024
-----
CO_01_PM>
```

#### Option:

C Updates the G.826 E1 parameters continuously

#### Definitions:

1. CRC4: Cyclic redundancy check indicating errored sub-multiframes received on the local 2Mbit/s E1 side.
2. E-bit: CRC-4 indication bit indicating received errored sub-multiframes on the 2Mbit/s E1 remote side.
3. FAS: Errored Frame Alignment Signal received on the 2Mbit/s E1 side. The criteria for severely errored seconds (SES) is 28 FAS-Errors per second. (In accordance to G.821)

### 8.3.3.3 RESETG826 Command

The RESETG826 command sets the G.826 error performance parameters back to zero.

```
CO_01_PM> RESETG826
G.826 error performance parameter reset
CO_01_PM>
```

### 8.3.4 Fault and maintenance management FMM

Fault and maintenance management activated  
Enter <M> to return to MAIN, or <H> for HELP information

Type <H>and the monitor lists all available commands in the fault and maintenance sub-menu.

### 8.3.4.1 SQ Command

The SQ command allows the user to toggle the signal quality trace on and off:

```
CO_01_FMM> SQ
signal quality trace on
xDSL SNR: local 38.8 dB, remote 39.0 dB
xDSL SNR: local 41.3 dB, remote 38.8 dB
xDSL SNR: local 38.6 dB, remote 39.0 dB
```

```
CO_01_FMM> SQ
signal quality trace off
CO_01_FMM>
```

**Note:** Repeater and units in Multipoint and Dual Pair modes represent data for both xDSL interfaces.

### 8.3.4.2 STARTUP Command

The STARTUP command allows the user to toggle the startup trace on and off, in order to observe the LTU / NTU activation state diagram transitions conforming to ITU-T G.991.2.

```
CO_01_FMM> STARTUP
xDSL transceiver startup trace on
CO_01_FMM>
CO_01_FMM> STARTUP
xDSL transceiver startup trace off
CO_01_FMM>
```

**Note:** Repeater and units in Multipoint and Dual Pair modes represent data for both xDSL interfaces.

### 8.3.4.3 STATUS Command

The STATUS command displays the actual system status:

```
CO_01_FMM> STATUS
-----
Local System Status
-----
LOSD      :      1
SEGA      :      1
PS        :      1
SEGD      :      1
Tx power  :  07.5 dBm
Rx gain   :  13.9 dB
Loop attn.:  00.0 dB
Bitrate   :  2064 kBit/s
SRU #     :      0
-----
CO_01_FMM>
```

#### Definitions:

**LOSD:** (Loss of Signal) Indicates the loss of signal from the application interface. Loss of Signal = 0, Normal = 1.

**SEGA:** (Segment Anomaly) Indicates a CRC error on the incoming xDSL frame. A segment anomaly indicates that a regenerator operating on a segment has received corrupted data and therefore the regenerated data is



unreliable. CRC Error =0, Normal = 1.

- PS: (Power Status)
- SEGD: (Segment Defect)
- Tx power: Local transmit power in dBm
- Rx gain: Local receiver gain in dB
- Loop attn.: Estimate of the loop attenuation in dB of the actual connection
- Bitrate: Bitrate of the actual connection
- SRU #: Number of detected repeater in loop

Note: Repeater and units in Multipoint and Dual Pair modes represent data for both xDSL interfaces.

### 8.3.4.4 ALARM Command

The ALARM command displays the actual alarm status:

CO\_01\_FMM> ALARM

-----  
Local Alarm Status  
-----

```

LOS-S      : off
LFA-S      : off
AIS-S      : off
AIS-R      : off
BER-S      : off
EXT-LOC    : off
DTROFF     : off
ETC-LOS    : off
LOS/LFA-H  : off
SEGD       : off
BER-H      : off
LOOP1      : off
LOOP2      : off
ALB        : off
TEST       : off

```

-----  
CO\_01\_FMM>

#### Options:

T : Turns alarm trace on / off

#### Definitions:

- LOS-S: Loss of signal at subscriber (E1) side
- LFA-S: Loss of frame alignment at subscriber (E1) side
- AIS-S: AIS (Alarm Indication Signal) detected at subscriber (E1) side
- AIS-R: AIS (Alarm Indication Signal) detected at subscriber (E1) side of remote unit

#### Definitions (continuation):

- BER-S: Excessive Block Error Rate on subscriber side  
If CRC4 enabled : BER-S = on if more than 805 CRC4 Errors per second.  
If CRC4 disabled : BER-S = on if more than 28 FAS Errors per second.

EXT-LOC: Loss of external clock

DTR OFF: V.35/V.36: DTR input is off  
X.21: RTS input is off

ETC-LOS: V.35/V.36/X.21: Loss of external timing reference

LOS/LFA-H: Loss of signal or frame alignment at xDSL loop

SEGD: Segment Defect indication

BER-H: xDSL block-error-rate according G.826  $\geq 30\%$

LOOP1: xDSL test loop 1 active (see section)

LOOP2: xDSL test loop 2 active

ALB: Analog loopback

TEST: At least one test function is active

Note: Repeater and units in Multipoint and Dual Pair modes represent data for both xDSL interfaces.

### 8.3.4.5 LOOP1 Command

The LOOP1 command starts the local loopback (see section 3.6.1: Standard Test Loops):

```
CO_01_FMM> LOOP1 ON
Loop 1 activated
CO_01_FMM>
```

```
CO_01_FMM> LOOP1 OFF
Loop 1 deactivated
CO_01_FMM>
```

### 8.3.4.6 LOOP2 Command

The LOOP2 command starts the remote loopback (see section 3.6.1: Standard Test Loops):

```
CO_01_FMM> LOOP2 R ON
remote loop activation initiated
CO_01_FMM>
```

```
CO_01_FMM> LOOP2 R OFF
remote loop deactivation initiated
```

Note: The remote loopback is only possible from the master side.

Note: In Multipoint mode LOOP2 command has additional parameter, which assign necessary xDSL interface.

Note: On ADD-DROP repeater LOOP2 can be activated locally. In this case LOOP2 command has parameter ON or OFF only.

### 8.3.4.7 STARTAL Command

The STARTAL command starts the analog loopback:

```
CO_01_FMM> STARTAL
analog loopback started
```

```
analog loopback active
CO_01_FMM>
```

Notes:

1. Detach the xDSL line before starting the analog loopback. If the analog loopback is started while a remote station is attached to the xDSL line, the remote station signal will interfere with the loopback signal, causing bit errors on the network interface.
2. To return to normal operation, type STARTAL again or use the RESET command.

Note: In Multipoint mode and for Repeater STARTAL command has a parameter, which assign necessary xDSL interface.

### 8.3.4.8 SPECTRUM Command

The SPECTRUM command initializes the xDSL analog output for power measurements.

```
CO_01_FMM>SPECTRUM
analog spectrum started
analog spectrum active
CO_01_FMM>
CO_01_FMM>SPECTRUM
analog spectrum stopped
CO_01_FMM>
```

Note: In Multipoint mode and for Repeater SPECTRUM command has a parameter, which assign necessary xDSL interface.

### 8.3.4.9 RESTART Command

By typing RESTART, the actual channel will be restarted.

```
CO_01_FMM> RESTART
restarting channel
CO_01_FMM>
```

Note: In Multipoint mode and for Repeater RESTART command has a parameter, which assign necessary xDSL interface.

### 8.3.4.10 RESET Command

By typing RESET, the system unit will be restarted.

```
CO_01_FMM> RESET
system reset
```

## 8.3.5 Configuration management CM

```
Configuration management activated
Enter <M> to return to MAIN, or <H> for HELP information
```

Type <**H**> and the monitor lists all available commands in the configuration sub-menu.

### 8.3.5.1 CONFIG Command

The CONFIG command displays the configuration of the unit.

Note: After each configuration change, the new configuration is automatically displayed.

### 8.3.5.2 G704 Command

Set framed mode / transparent mode.

Note: This command does not supported in Multipoint mode, as well as in ADD-DROP repeater monitor.

### 8.3.5.3 CRC4DET Command

Set CRC4 detection on / off

### 8.3.5.4 CRC4GEN Command

Set CRC4 generation on / off

### 8.3.5.5 EBIT Command

Set automatic E-Bit insertion on / off

### 8.3.5.6 AISGEN Command

Set AIS generation on / off

### 8.3.5.7 AISDET Command

Set AIS detection on / off

### 8.3.5.8 EXTCLK Command

Set external clock mode on / off

Note: This command exists for LTU only.

### 8.3.5.9 SERVICE Command

Select one of four available services:

[E] : E1 only

[N] : Nx64 only

[M] : Multiservice Nx64 & fE1 (fractional E1)

[T] : E1-TS16 mode (For SW versions starting from 1.6.5.4)

### 8.3.5.10 TYPE Command

This command sets the Nx64 interface type.

0: V.35

1: V.36/X.21 without termination

2: V.36/X.21 with termination

### 8.3.5.11 BITRATE Command

Set Nx64 payload bit rate to [1..32] x 64 kBit/s.

In Nx64 only mode, the timeslot mapping is from 0 to 31 (if SLOTUSAGE ON configured) or from 1 to 31 (if SLOTUSAGE OFF configured).

In multiservice mode, the timeslot mapping is from 1 to 15, 17 to 31. The remaining timeslots are available for fE1. If payload bit rate is 31 x 64 kBit/s, TS16 is used. If payload bit rate is 32 x 64 kBit/s, then TS0 is used, too.

### 8.3.5.12 CLOCKMODE Command

Nx64 only: Set Nx64 unit clock mode to 'external', i.e. the internal PLL of the modem (DCE) is enabled, or 'internal', i.e. the modem (DCE) is clock master and the PLL is disabled. 'internal' clock mode is not applicable when the unit is configured as xDSL slave.

E1 only or multiservice: The Nx64 clock is derived from the E1 port.

### 8.3.5.13 CLOCKDIR Command

Set Nx64 port clock direction to co directional or contra directional. Co directional uses input line 113 for TXD sampling, contra directional uses output line 114 for TXD sampling.

### 8.3.5.14 CLOCKEGDE Command

Set Nx64 TXD data sampled at normal or inverted clock edge.

### 8.3.5.15 SLOTUSAGE Command

Set usage of timeslot 0 for Nx64 only mode on / off.

### 8.3.5.16 AUTOLOOP Command

This command enables/disables the usage of lines 140/141 for automatic V.54 loop control.

### 8.3.5.17 MODE Command

This command sets the operation mode.

N: Normal mode

D: Dual pair mode

M: Multipoint mode

T: E1-TS16 mode (for SW versions before 1.6.5.4)

### 8.3.5.18 MASTER Command

Set xDSL master/slave mode. One unit must be configured as master, the other as slave.

### 8.3.5.19 PLL Command

This command enables/disables the PLL on channel A of xDSL port.

### 8.3.5.20 ID Command

This command sets a unique identification string printed on the main screen.

### 8.3.5.21 RESTART Command

Set auto restart on / off

### 8.3.5.22 BASERATE Command

This command sets the base rate for xDSL interface. This value must be between 3 and 32 and defines the available 64 Kbit/s channels. To optimize the bandwidth of your connection, you have to set the base rate value to the maximum where you get a stable connection.

Note: In Multipoint mode BASERATE command has two parameters for each xDSL interface.

Note: In Repeater ADD-DROP monitor BASERATE sets the base rate for C-side xDSL interface.

### 8.3.5.23 PCM Command

This command enables/disables timeslot 16 processing:

[30]: Set timeslot 16 processing on.

[31]: Set timeslot 16 processing off

### 8.3.5.24 IDLECAS Command

This command sets the idle pattern (1..F) for TS16.

### 8.3.5.25 PAYLOAD Command

In multipoint mode this command sets the numbers of channel timeslots to be transmitted to xDSL interfaces A and B.

In ADD-DROP repeater monitor this command sets the numbers of channel timeslots to be transmitted to C-side xDSL and E1 interfaces.

### 8.3.5.26 TS0SRC Command

Set source for receiving TS0 and MFAS:

C - DSL C side; E - E1.

### 8.3.5.27 ADAPTIVE Command

Set rate adaption on / off

### 8.3.5.28 POWER Command

Set remote power on/off

### 8.3.5.29 DEFAULT Command

The DEFAULT command sets a default configuration. Six default settings are available (three for master, three for slave) in each of following modes: E1 only Normal or Dual Pair mode; Nx64 only Normal or Dual Pair mode; fE1 & Nx64 Normal or Dual Pair mode and Multipoint Mode.

#### 8.3.5.29.1 E1 only Normal or Dual Pair mode

```
CO_CM>DEFAULT 0
```

```
-----  
Local Configuration  
-----
```

```
2 Mbit/s  
Framing          : Transparent  
CRC4 Detection   : --  
CRC4 Generation : --  
E-Bit Insertion : --  
AIS Detection    : on  
AIS Generation   : on  
External Clock   : off
```

```
Nx64  
Service          : E1 only  
Interface Type   : --  
Bitrate          : --  
Clock Mode       : --  
Clock Direction  : --  
Clock Edge       : --  
Use Timeslot 0   : --  
V.54 Loops       : --
```

```
xDSL  
Mode             : Normal
```

```

Master/Slave      : Master
  Power           :      : off
PLL               : off
Auto restart      : on
Base Rate         : 32
Rate Adaption     : off
CO_CM>DEFAULT 1

```

-----  
Local Configuration  
-----

```

2 Mbit/s
Framing           : ITU-T G.704
CRC4 Detection    : on
CRC4 Generation   : off
E-Bit Insertion   : --
AIS Detection     : on
AIS Generation    : on
External Clock    : off

```

```

Nx64
Service           : E1 only
Interface Type    : --
Bitrate           : --
Clock Mode        : --
Clock Direction   : --
Clock Edge        : --
Use Timeslot 0    : --
V.54 Loops        : --

```

```

xDSL
Mode              : Normal
Master/Slave      : Master
  Power           :      : off
PLL               : off
Auto restart      : on
Base Rate         : 32
Rate Adaption     : off
CO_CM>DEFAULT 2

```

-----  
Local Configuration  
-----

```

2 Mbit/s
Framing           : ITU-T G.704
CRC4 Detection    : on
CRC4 Generation   : on
E-Bit Insertion   : on
AIS Detection     : on
AIS Generation    : on
External Clock    : off

```

```

Nx64
Service           : E1 only
Interface Type    : --
Bitrate           : --
Clock Mode        : --
Clock Direction   : --
Clock Edge        : --
Use Timeslot 0    : --
V.54 Loops        : --

```

```

xDSL
Mode              : Normal
Master/Slave      : Master
  Power           :      : off
PLL               : off
Auto restart      : on
Base Rate         : 32
Rate Adaption     : off

```

### 8.3.5.29.2 Nx64 only Normal or Dual Pair mode

```
CO_CM>DEFAULT 0
```

-----  
Local Configuration  
-----

```
2 Mbit/s
```



```

Framing      : --
CRC4 Detection : --
CRC4 Generation : --
E-Bit Insertion : --
AIS Detection : --
AIS Generation : --
External Clock : --
Nx64
Service      : Nx64 only
Interface Type : V.35
Bitrate      : 512 Kbit/s
Clock Mode   : internal
Clock Direction : contra directional
Clock Edge   : inverted
Use Timeslot 0 : no
V.54 Loops   : disabled
xDSL
Mode         : Normal
Master/Slave : Master
PLL          : off
Auto restart : on
Base Rate    : 09
Rate Adaption : off

```

-----

CO\_CM>DEFAULT 1

-----

Local Configuration

-----

```

2 Mbit/s
Framing      : --
CRC4 Detection : --
CRC4 Generation : --
E-Bit Insertion : --
AIS Detection : --
AIS Generation : --
External Clock : --
Nx64
Service      : Nx64 only
Interface Type : V.35
Bitrate      : 1024 Kbit/s
Clock Mode   : internal
Clock Direction : contra directional
Clock Edge   : inverted
Use Timeslot 0 : no
V.54 Loops   : disabled
xDSL
Mode         : Normal
Master/Slave : Master
PLL          : off
Auto restart : on
Base Rate    : 17
Rate Adaption : off

```

-----

CO\_CM>DEFAULT 2

-----

Local Configuration

-----

```

2 Mbit/s
Framing      : --
CRC4 Detection : --
CRC4 Generation : --
E-Bit Insertion : --
AIS Detection : --
AIS Generation : --
External Clock : --
Nx64
Service      : Nx64 only
Interface Type : V.35
Bitrate      : 2048 Kbit/s
Clock Mode   : internal
Clock Direction : contra directional
Clock Edge   : inverted
Use Timeslot 0 : yes

```

```
V.54 Loops      : disabled
xDSL
Mode           : Normal
Master/Slave   : Master
PLL            : off
Auto restart   : on
Base Rate      : 32
Rate Adaption  : off
```

---

### 8.3.5.29.3 fE1 & Nx64 Normal or Dual Pair mode

CO\_CM>DEFAULT 0

-----  
 Local Configuration  
 -----

```
2 Mbit/s
Framing        : ITU-T G.704
CRC4 Detection : on
CRC4 Generation : on
E-Bit Insertion : on
AIS Detection  : on
AIS Generation  : on
External Clock : off
Nx64
Service        : Nx64 & fE1
Interface Type : V.35
Bitrate        : 256 Kbit/s
Clock Mode     : from E1
Clock Direction : contra directional
Clock Edge     : inverted
Use Timeslot 0 : --
V.54 Loops     : disabled
xDSL
Mode           : Normal
Master/Slave   : Master
PLL            : off
Auto restart   : on
Base Rate      : 32
Rate Adaption  : off
```

CO\_CM>DEFAULT 1

-----  
 Local Configuration  
 -----

```
2 Mbit/s
Framing        : ITU-T G.704
CRC4 Detection : on
CRC4 Generation : on
E-Bit Insertion : on
AIS Detection  : on
AIS Generation  : on
External Clock : off
Nx64
Service        : Nx64 & fE1
Interface Type : V.35
Bitrate        : 512 Kbit/s
Clock Mode     : from E1
Clock Direction : contra directional
Clock Edge     : inverted
Use Timeslot 0 : --
V.54 Loops     : disabled
xDSL
Mode           : Normal
Master/Slave   : Master
PLL            : off
Auto restart   : on
Base Rate      : 32
Rate Adaption  : off
```

CO\_CM>DEFAULT 2

-----  
 Local Configuration  
 -----

```

2 Mbit/s
  Framing      : ITU-T G.704
  CRC4 Detection : on
  CRC4 Generation : on
  E-Bit Insertion : on
  AIS Detection : on
  AIS Generation : on
  External Clock : off
Nx64
  Service      : Nx64 & fE1
  Interface Type : V.35
  Bitrate      : 1024 Kbit/s
  Clock Mode   : from E1
  Clock Direction : contra directional
  Clock Edge   : inverted
  Use Timeslot 0 : --
  V.54 Loops   : disabled
xDSL
  Mode         : Normal
  Master/Slave : Master
  PLL          : off
  Auto restart : on
  Base Rate    : 32
  Rate Adaption : off
  
```

### 8.3.5.29.4 Multipoint Mode

CO\_CM>DEFAULT 0

-----  
 Local Configuration [A/B]  
 -----

```

2 Mbit/s
  Framing      : ITU-T G.704
  CRC4 Detection : on
  CRC4 Generation : on
  E-Bit Insertion : on
  AIS Detection : on
  AIS Generation : on
  External Clock : off
  PCM Mode      : PCM31
  Payload       : 16      15
xDSL
  Mode         : Multipoint
  Master/Slave : Master
  PLL          : off
  Auto restart : on      on
  Base Rate    : 17      16
  Rate Adaption : off    off
  
```

CO\_CM>DEFAULT 1

-----  
 Local Configuration [A/B]  
 -----

```

2 Mbit/s
  Framing      : ITU-T G.704
  CRC4 Detection : on
  CRC4 Generation : on
  E-Bit Insertion : on
  AIS Detection : on
  AIS Generation : on
  External Clock : off
  PCM Mode      : PCM30
  Idle pattern  : 0xD
  Payload       : 15      15
xDSL
  Mode         : Multipoint
  Master/Slave : Master
  PLL          : off
  
```

Auto restart : on on  
Base Rate : 17 17  
Rate Adaption : off off

---

CO\_CM>

### 8.3.5.29.5 Add-Drop Repeater

CO\_CM>DEFAULT 0

-----  
Local Configuration [A/B]  
-----

```

2 Mbit/s
Framing          :  --
CRC4 Detection   :  --
CRC4 Generation  :  --
E-Bit Insertion  :  --
AIS Detection    :  --
AIS Generation   :  --
TSOSRC          :  C-side xDSL
PCM Mode        :  PCM31
Payload         :  31    0
xDSL
Auto restart    :  on    on
Base Rate      :  32
Rate Adaption   :  off

```

CO\_CM>DEFAULT 1

-----  
Local Configuration [A/B]  
-----

```

2 Mbit/s
Framing          :  ITU-T G.704
CRC4 Detection   :  On
CRC4 Generation  :  On
E-Bit Insertion  :  On
AIS Detection    :  On
AIS Generation   :  On
TSOSRC          :  C-side xDSL
PCM Mode        :  PCM31
Payload         :  21    10
xDSL
Auto restart    :  on    on
Base Rate      :  32
Rate Adaption   :  off

```

CO\_CM>DEFAULT 1

-----  
Local Configuration [A/B]  
-----

```

2 Mbit/s
Framing          :  ITU-T G.704
CRC4 Detection   :  On
CRC4 Generation  :  On
E-Bit Insertion  :  On
AIS Detection    :  On
AIS Generation   :  On
TSOSRC          :  C-side xDSL
PCM Mode        :  PCM30
Idle CAS        :  :  0xD
Payload         :  20    10
xDSL
Auto restart    :  on    on
Base Rate      :  32
Rate Adaption   :  off

```

## 9 Software update

### 9.1 General

The software of the BLACK BOX-DSL boards has the possibility for field updates. To do a field update, you need only a Windows 95/98/NT computer, the *Flash Loader* program installed, a connection between the Windows computer and the LTU/NTU Monitor connector and the newest release of the BLACK BOX-DSL software.

### 9.2 Software download

To update the software on your LTU/NTU you have to run through the following steps:

- 1.) Switch off the power of your LTU/NTU.
- 2.) Connect the LTU/NTU monitor connector with your Windows computer's RS232 interface.
- 3.) Start the *Flash Loader* software on your Windows computer
- 4.) Choose *Set Loader Communication* in the menu *Setting*. Select the right communication port, the communication information and press *Ok*.

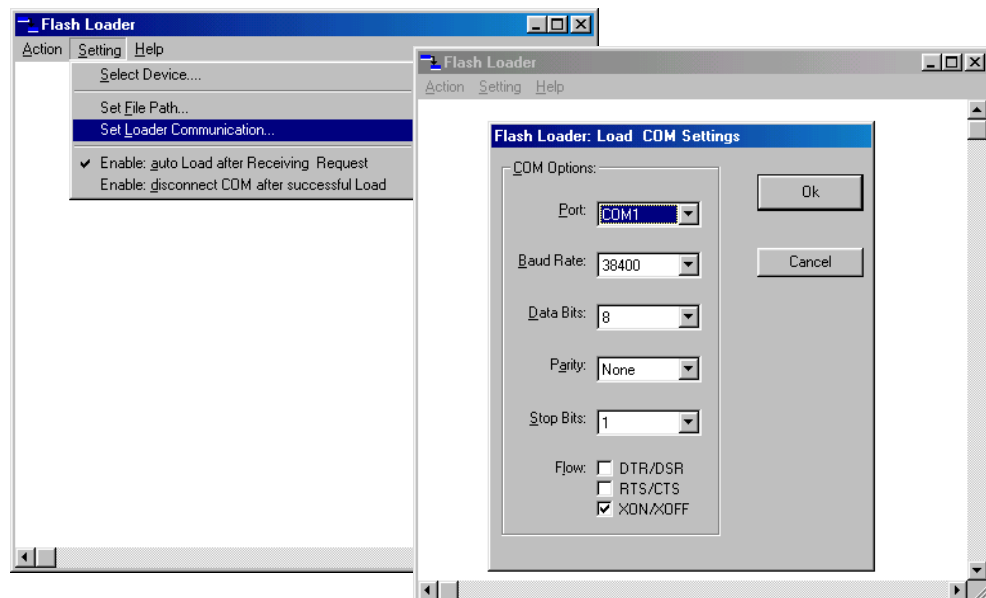

- 5.) Choose *Select Device* in the *Setting* menu, select the device BlackBox and press *Ok*.

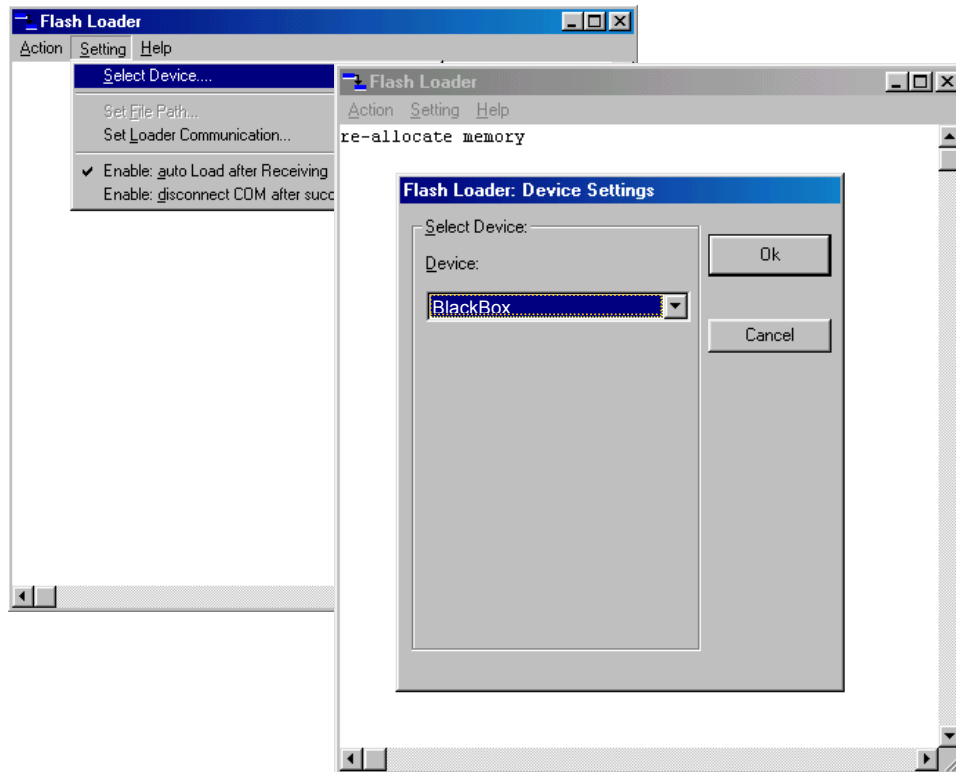

- 6.) Choose the newest software version and press *Öffnen*.

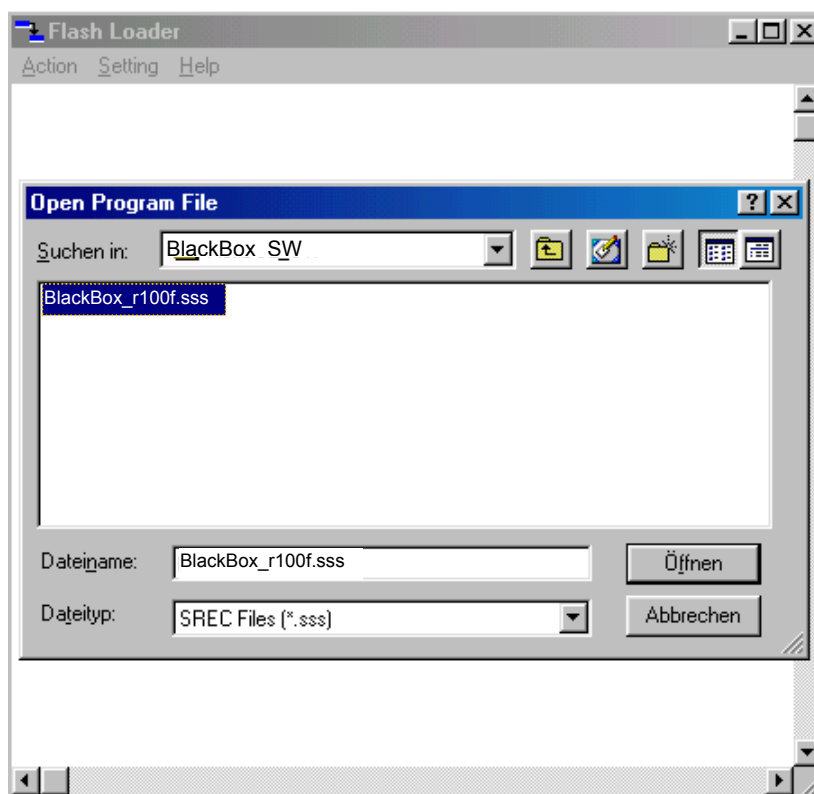

- 7.) Execute the command *Connect COM* in the menu *Action*.

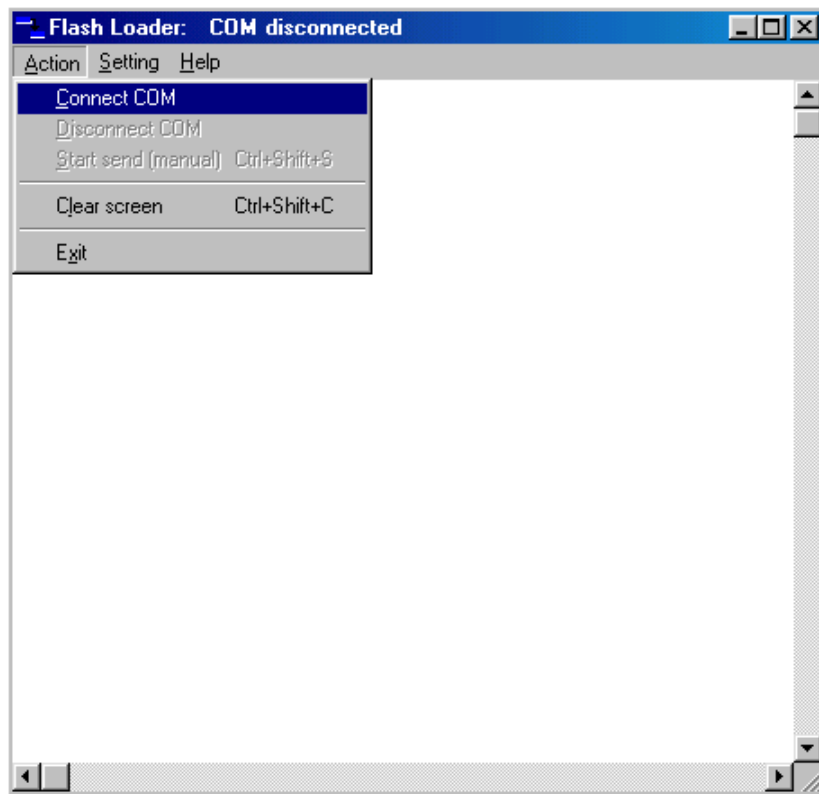

- 8.) Switch on the power of your LTU/NTU.  
9.) The following message appears on the screen, then press *Ja*.



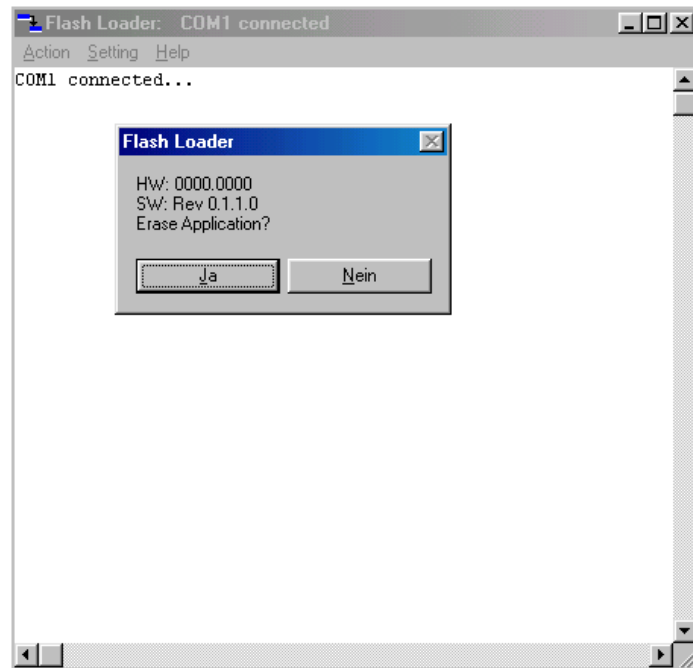

- 10.) During the download the FE-LED is green blinking and the NE-LED is amber. On the Windows screen you see the ongoing download.

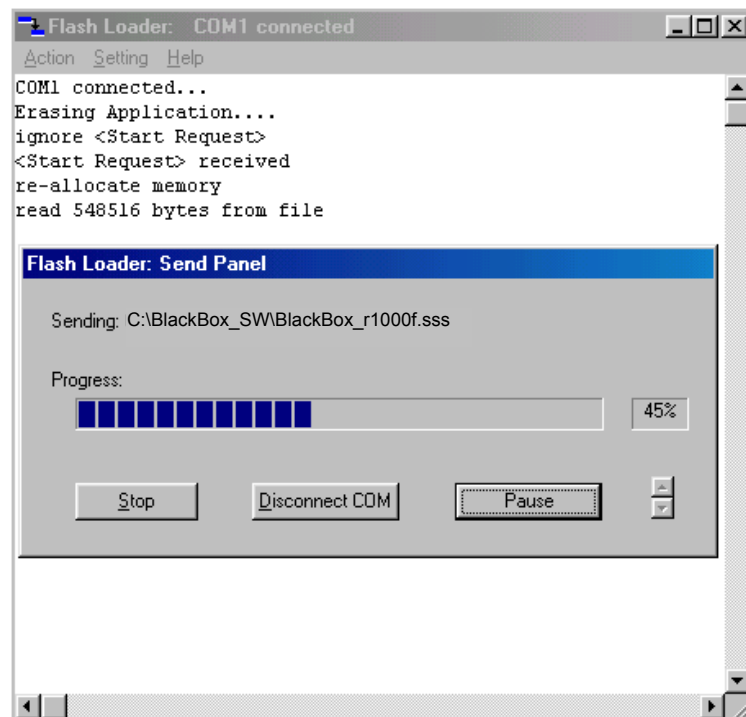

- 11.) If the download is successfully finished the *Flash Loader* program sends the following message:

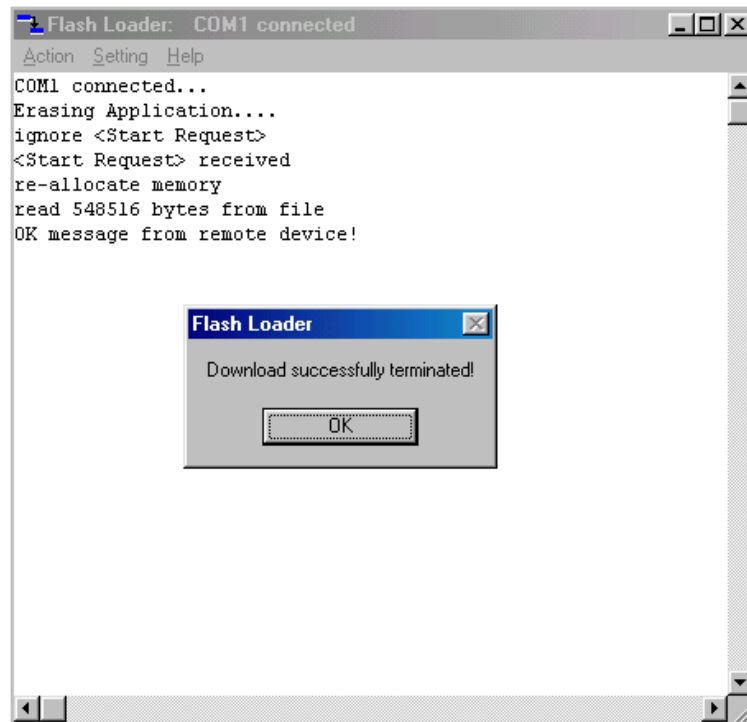

- 12.) If the download was successful, the LTU/NTU restarts automatically.

## 10 Connectors' Description

---

### 10.1 xDSL Connector (MDS923C-V35X21 and MDS920C-2E1)

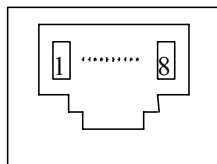

Front View  
RJ45-8

Pin	Signal	Description
1	TXB.a	4-wire Tx Loop B, Tip
2	TXB.b	4-wire Tx Loop B, Ring
3	TXA.a	4-wire Tx Loop A, Tip
4	LA.a	Loop A, Tip / 4-wire Rx Loop A, Tip
5	LA.b	Loop A, Ring / 4-wire Rx Loop A, Ring
6	TXA.b	4-wire Tx Loop A, Ring
7	LB.a	Loop B, Tip / 4-wire Rx Loop B, Tip
8	LB.b	Loop B, Ring / 4-wire Rx Loop B, Ring

### 10.2 xDSL Connector

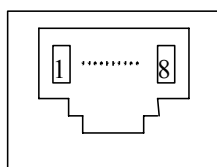

Front View  
RJ45-8

Pin	Signal	Description
1	NC	Not used
2	Shield	DSL cable shield
3	TXA.a	Loop B, Tip (C-side)
4	LA.a	Loop A, Tip (N-side)
5	LA.b	Loop A, Ring (N-side)
6	TXA.b	Loop B, Ring (C-side)
7	Shield	DSL cable shield
8	NC	Not used

### 10.3 E1 120 Ohm Connector

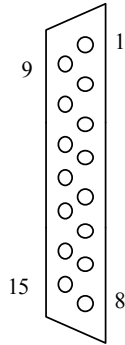

Pin	Signal	Description
1	RX1a	E1 120Ω Output 1 (wire A)
2	FPE	Functional Protective Earth (cable shield RX1)
3	TX1a	E1 120Ω Input 1 (wire A)
4	FPE	Functional Protective Earth (cable shield TX1)
5	FPE	Functional Protective Earth (cable shield TX2)
6	TX2a	E1 120Ω Output 2 (wire A)
7	FPE	Functional Protective Earth (cable shield RX2)
8	RX2a	E1 120Ω Input 2 (wire A)
9	RX1b	E1 120Ω Output 1 (wire B)
10	NC	-
11	TX1b	E1 120Ω Input 1 (wire B)
12	NC	-
13	TX2b	E1 120Ω Output 2 (wire B)
14	NC	-
15	RX2b	E1 120Ω Input 2 (wire B)

### 10.4 E1 75 Ohm In / Out Connectors

Type: BNC 75 Ω

Optionally equipped for E1 interface with 75 Ω

## 10.5 V.35 DCE Connector

Pin	V.24 (V.35/V.36)			X.21		Direction
	ITU-T #	Description	Name	Description	Name	
1	-			Shield		
7	102	Signal Gnd	SG	Signal Gnd	G	
2	103a	Transmit Data (A)	TD(A)	Transmit (A)	Ta	To DCE
14	103b	Transmit Data (B)	TD(B)	Transmit (B)	Tb	To DCE
3	104a	Receive Data (A)	RD(A)	Receive (A)	Ra	To DTE
16	104b	Receive Data (B)	RD(B)	Receive (B)	Rb	To DTE
4	105a	Request To Send (A)	RTS(A)	Control (A)	Ca	To DCE
19	105b	Request To Send (B)	RTS(B)	Control (B)	Cb	To DCE
5	106a	Clear To Send (A)	CTS(A)	Indication (A)	Ia	To DTE
13	106b	Clear To Send (B)	CTS(B)	Indication (B)	Ib	To DTE
6	107a	Data Set Ready (A)	DSR(A)			To DTE
22	107b	Data Set Ready (B)	DSR(B)			To DTE
20	108a	Data Terminal Ready (A)	DTR(A)			To DCE
23	108b	Data Terminal Ready (B)	DTR(B)			To DCE
8	109a	Data Carrier Detect (A)	DCD(A)			To DTE
10	109b	Data Carrier Detect (B)	DCD(B)			To DTE
24	113a	Terminal Transmit Clock (A)	TTC(A)	DTE Signal Element Timing (A)	Xa	To DCE
11	113b	Terminal Transmit Clock (B)	TTC(B)	DTE Signal Element Timing (B)	Xb	To DCE
15	114a	Transmit Clock (A)	TC(A)			To DTE
12	114b	Transmit Clock (B)	TC(B)			To DTE
17	115a	Receive Clock (A)	RC(A)	Signal Element Timing (A)	Sa	To DTE
9	115b	Receive Clock (B)	RC(B)	Signal Element Timing (B)	Sb	To DTE
21	140	Remote Loopback	RLB			To DCE
18	141	Local Loopback	LLB			To DCE
25	142	Test Mode	TM			To DTE

## 10.6 Monitor Interface

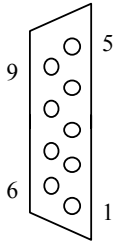

- on NTU only

Pin	Signal	Description
1	FPE	Functional Protective Earth
2	TXD	EIA-232 Transmit Data
3	RXD	EIA-232 Receive Data
4	ALACOM	Common Contact*
5	SGND	EIA-232 Signal Ground
6	ALMAJ_NC	Major Alarm Contact, normally closed*
7	ALMAJ_NO	Major Alarm Contact, normally open*
8	ALMIN_NC	Minor Alarm Contact, normally closed*
9	ALMIN_NO	Minor Alarm Contact, normally open*

## 10.7 Power Interface (MDS921AE-E1 and MDS923AE-V35X21)

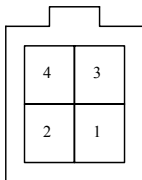

Pin	Signal	Description
1	-MainsPWR	Negative power supply terminal for mains adapter
2	NC	-
3	-BatPWR	Negative terminal for battery power supply (fused)
4	+PWR	Positive power supply terminal

## 10.8 Power Interface

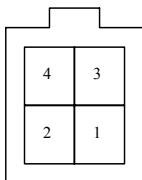

Molex Mini-Fit, 4-pin

Pin	Signal	Description
1	-MainsPWR	Negative power supply terminal for mains adapter
2	FPE	Functional Protective Earth
3	NC	-
4	+PWR	Positive power supply terminal

# 11 Technical Specification

---

## 11.1 Interfaces

### 11.1.1 xDSL Line Interface

Specification	ITU-T G.SHDSL, Rec G.991.2
Option	4-wire Interface (separate Tx and Rx Pairs)
Line Code	TC-PAM (G.SHDSL)
Impedance	135Ω
Transmit Power	13.5 dBm @ 135 Ω
Number of Pairs	1 or 2 (option: 2 or 4)
Bit Rate	192 to 2064 kbps
Connector Type	RJ-45, 8 pin
Overvoltage Protection Specification	ITU-T Rec. K.20/K.21
Wetting Current	2-4 mA @ 60 V

### 11.1.2 E1 Line Interface

Specification	ETS 300 166, ITU-T Rec G.703, G.704
Number of Interfaces	1 or 2
Line Code	HDB3
Impedance	either 120Ω or 75Ω
Jitter	ITU-T Rec G.823, ETSI TS 101 135
Bit Rate	2048 Kbit/s ± 50 ppm
Connector Type	either DB15 male (120Ω) or two BNC 75Ω
ESD Protection	8 kV (Air discharge)

### 11.1.3 V.35 DCE User Interface

Specification	ITU-T Rec V.35/V.36/X.21
Number of Interfaces	1
Connector Type	DB25 female

### 11.1.4 Monitor Interface

Specification	EIA-232 / V.28
Data Rate	9600 baud, asynchronous
Protocol	8 bit, no parity, 1 stop bit no linefeed with carriage return XON/XOFF enabled
Signal Level	V.28 on DB9 female connector
Connector Type	DB9 female connector

### 11.2 Power Supply

Specification	ETSI ETS 300 132-2
Plug-in	2 x 40V/60V <sub>DC</sub> over backpanel (redundant)
Tabletop	1 x 40V/60V <sub>DC</sub> over Molex type safety approved connector or 38..200Vdc over xDSL

### 11.3 Environmental

#### 11.3.1 Climatic Conditions

Storage:	ETS 300 019-1-1 Class 1.2	(-25°C ... +55°C)
Transportation:	ETS 300 019-1-2 Class 2.3	(-40°C ... +70°C)
Operation:	ETS 300 019-1-3 Class 3.2	(-5°C ... +45°C)

#### 11.3.2 Safety / EMC

According to EN60950 / EN 55022 , Class B

### 11.4 Physical Dimensions and Weight

19" Plug-in unit:

Dimensions:	height: 262 mm (6 HE), width: 30 mm
Weight:	0.5 kg

Minirack:

Dimension:	483(W)x230(D)x43.5(H) mm
Weight:	3 kg

NTU and repeater:

Dimensions:	230(W)x160(D)x46(H) mm
Weight:	0.7 kg



## 12 Nx64 cables

### V.35 DTE

Connect to a DTE device

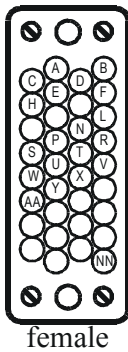

V.35/ISO 2593  
34 Pin Connector

#	MRAC-34, female (a/b)	DB25, male (a/b)
FGND	A	1
SGND	B	7
103	P/S	2/14
104	R/T	3/16
105	C	4
106	D	5
107	E	6
108	H	20
109	F	8
113	U/W	24/11
114	Y/AA	15/12
115	V/X	17/9
140	N	21
141	L	18
142	NN	25

### V.35 DCE

Connect to a DCE device

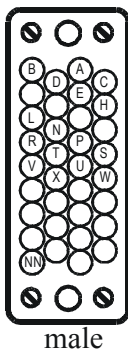

V.35/ISO 2593  
34 Pin Connector

#	MRAC-34, male (a/b)	DB25, male (a/b)
FGND	A	1
SGND	B	7
103	P/S	3/16
104	R/T	2/14
105	C	5
106	D	4
107	E	20
108	H	6
109	-	-
113	U/W	17/9
114	-	-
115	V/X	24/11

### V.36/RS449 DTE

Connect to a DTE device

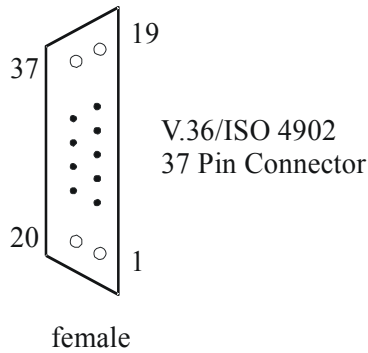

#	DB37, female (a/b)	DB25, male (a/b)
FGND	1	1
SGND	19	7
SGND(a)	37	7
SGND(b)	20	7
103	4/22	2/14
104	6/24	3/16
105	7/25	4/19
106	9/27	5/13
107	11/29	6/22
108	12/30	20/23
109	13/31	8/10
113	17/35	24/11
114	5/23	15/12
115	8/26	17/9
140	14	21
141	10	18
142	18	25

### V.36/RS449 DCE

Connect to a DCE device

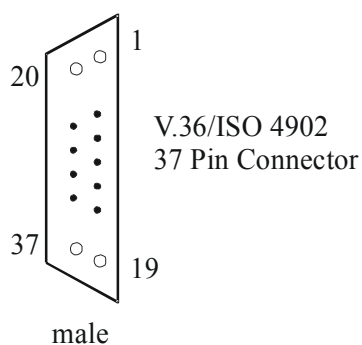

#	DB37, male (a/b)	DB25, male (a/b)
FGND	1	1
SGND	19	7
SGND(a)	37	7
SGND(b)	20	7
103	4/22	3/16
104	6/24	2/14
105	7/25	5/13
106	9/27	4/19
107	11/29	20/23
108	12/30	6/22
113	17/35	17/9
115	8/26	24/11

### X.21 DTE

Connect to a DTE device

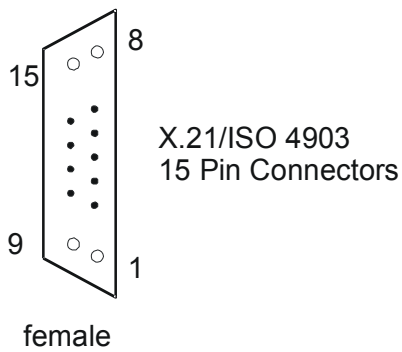

#	DB15, female (a/b)	DB25, male (a/b)
FGND	1	1
G	8	7
S	6/13	17/9
R	4/11	3/16
T	2/9	2/14
C	3/10	4/19
I	5/12	5/13
X	7/14	24/11

Note: join together pins 22&23 and 6&20 at DB-25 side

### X.21 DCE

Connect to a DCE device

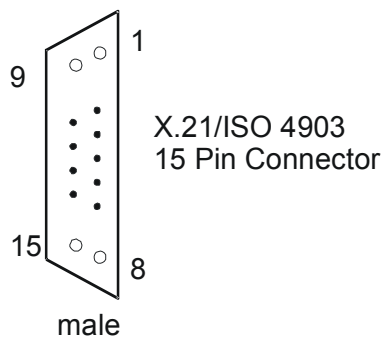

#	DB15, male (a/b)	DB25, male (a/b)
FGND	1	1
G	8	7
S	6/13	24/11
R	4/11	2/14
T	2/9	3/16
C	3/10	5/13
I	5/12	4/19
X	7/14	17/9

Note: join together pins 22&23 and 6&20 at DB-25 side

# 13 Appendices

---

## 13.1 Initialization Errors

At system startup, various hardware selftests are performed. If any initialization error occurs, the startup procedure will be aborted and the monitor will display an initialization error code in hexadecimal representation. Each bit of the word value corresponds to a specific initialization error and is set to one if the corresponding hardware is faulty. The table below lists the possible initialization errors and their corresponding bit position in the error code word.

Bit Nr	Initialization Error
0	Microcontroller RAM test failure
1	
2	
3	
4	
5	
6	
7	
8	
9	
10	
11	
12	
13	
14	
15	

## 13.2 Abbreviations

<b>2B1Q</b>	2 Binary - 1 Quaternary
<b>ACO</b>	Alarm Cut Off
<b>AIS</b>	Alarm Indication Signal
<b>AIS-R</b>	Alarm Indication Signal (Alarm bit in xDSL frame)
<b>AIS-S</b>	Alarm Indication Signal Subscriber
<b>BER-H</b>	Block Error Rate High (> 30 % according G.826)
<b>BER-L</b>	Block Error Rate Low (> 15 % & < 30% according G.826)
<b>BER-S</b>	Excessive Block Error Rate (CRC-4 Errors > 805) on Subscriber
<b>CCITT</b>	International Telegraph and Telephone Consultative Committee
<b>CCS</b>	Common Channel Signaling
<b>CMU</b>	Control and Management Unit
<b>CRC</b>	Cyclic Redundancy Check
<b>E1</b>	ITU-T G.703 User Interface at 2048 Kbit/s
<b>ET</b>	Exchange Termination
<b>EOC</b>	Embedded Operations Channel
<b>FAS</b>	Frame Alignment Signal
<b>FC</b>	Failure Condition
<b>FEBE</b>	Far End Block Error
<b>HDSL</b>	High Bit Rate Digital Subscriber Loop
<b>HRP</b>	HDSL Regenerator Present
<b>ISDN</b>	Integrated Services Digital Network
<b>ITU-T</b>	International Telecommunication Union
<b>LFA</b>	Loss of Frame Alignment
<b>LFA-L</b>	Loss of Frame Alignment xDSL
<b>LFA-S</b>	Loss of Frame Alignment Subscriber
<b>LOS-L</b>	Loss of Signal
<b>LOS-S</b>	Loss of Signal Subscriber side
<b>LT</b>	Line Termination
<b>LTU</b>	Line Termination Unit
<b>NC</b>	Not Connected
<b>NEXT</b>	Near End Cross Talk
<b>NM</b>	Noise Margin
<b>NT</b>	Network Termination
<b>NTU</b>	Network Termination Unit

<b>PDH</b>	Plesiochronous Digital Hierarchy
<b>PRA</b>	Primary Rate Access
<b>RX</b>	Receive
<b>SDH</b>	Synchronous Digital Hierarchy
<b>SMF</b>	Sub-Multiframe
<b>SQ</b>	Signal Quality
<b>TE</b>	Terminal Equipment
<b>TMN</b>	Telecommunication Management Network
<b>TX</b>	Transmit
<b>UIF</b>	User Interface
<b>UTP</b>	Unshielded Twisted Pair
<b>XVR</b>	Transceiver

## 13.3 References

### 13.3.1 Standards

ETSI ETR 152, “Transmission and Multiplexing (TM); High Bit Rate Digital Subscriber Line (xDSL) Transmission System on Metallic Local Lines; xDSL Core Specification and Applications for 2048 Kbit/s Based Access Digital Sections”

ITU-T G.821, “Error Performance of an International Digital Connection Forming Part of an Integrated Services Digital Network”

ITU-T G.826, “Error Performance Parameters and Objectives for International, Constant Bit Rate Digital Paths at or above the Primary Rate”

ITU-T G.823, “The Control of Jitter and Wander within Digital Networks Which Are Based on the 2048 Kbit/s Hierarchy”

ITU-T G.703, “Physical/Electrical Characteristics of Hierarchical Digital Interfaces”

ITU-T G.704, “Synchronous Frame Structures Used at Primary and Secondary Hierarchical Levels”

ITU-T M.3400, “TMN Management Functions”

ITU-T K.20, “Resistibility of Telecommunication Switching Equipment to Overvoltages and Overcurrents”

ITU-T K.21, “Resistibility of Subscribers’ Terminals to Overvoltages and Overcurrents”

EN 60950, “Safety of Information Technology Equipment Including Electrical Business Equipment”

EN 55022, “Grenzwerte und Messverfahren für Funkstörungen von informationstechnischen Einrichtungen”

ETS 300 019, “Equipment Engineering; Environmental Conditions and Environmental Tests for Telecommunications Equipment”