



***LWU1000
Users' Manual 1.0***

Laser safety regulations for the Black-Box FSO
communication systems



Black-Box FSOseries is a Class 1M Free Space Optical Communication System

It may be installed in

Unrestricted Locations,

areas that are normally accessible to the public; (e.g., unrestricted areas of rooftops, public areas at ground level, open areas of offices and industrial premises, etc).

Restricted Locations

areas that are normally inaccessible by the public - including workers, visitors, and residents in the immediate environs - by means of any administrative or engineering control measure but that is accessible to authorized personnel; (e.g. maintenance or service personnel including window cleaners in exterior locations that may not have laser safety training)

Controlled locations

locations where any kind of engineering or administrative control measure is introduced to make it inaccessible except to authorized personnel with appropriate laser safety training (e.g., tower mounted terminals, fenced/secure areas of rooftops, locked rooms with strictly-controlled access, etc.).

For additional details, please refer to **IEC 60825: SAFETY OF LASER PRODUCTS Part 12:** (Safety of free space optical communication systems used for transmission of information.)

Installation Restrictions for unrestricted areas:

To install a Black Box FSO system in an unrestricted location, the link head must be installed *3 meters* high or higher *above the surface* of the unrestricted area or must be *1 meter* or closer *to the edge* of the unrestricted area.

If a Black Box FSO system is installed in an unrestricted area, a *warning sign* must be posted that states. Do not use optical aids to view the FSO link heads.

Copyright 2005. Black Box Corporation. All rights reserved

Installation Restrictions for Restricted areas:

There are no special requirements for a Black Box FSO system installed in a restricted area.

Installation Restrictions for controlled areas:

No special requirements for a Black Box FSO system installed in a controlled area.

The laser system shall be installed in accordance with ANSI Z136.1 control measures (engineering, administrative, and procedural controls).

Copyright 2005. Black Box Corporation. All rights reserved

1 Table of contents

1	Table of contents	4
2	Introduction	5
2.1	What is FSO?	5
2.2	Optical Free-space Transmission	7
2.3	Typical applications	8
3	The product BlackBox	9
4	Content of the package	11
5	Sites of installation	11
5.1	Key factors of operation	11
5.2	Preferred installation sites	12
5.3	Direct sunshine	14
6	Eye safety	14
6.1	Mounting brackets for LWU1000s	15
7	System installation	17
7.1	On the table test	17
7.1.1	How can you install the ODIU?	19
7.1.2	Fixing the heads	22
7.1.3	Alignment of the heads	22
7.1.4	Connecting to your Network	25
7.1.5	Connecting to the management	26
7.2	Outdoor interconnection unit with Heater	27
7.3	48 VDC Power supply connections	29
8	Warranty conditions	30
9	Appendix A	32
a.	Product registration form	32
b.	Failure report form	33

Copyright 2005. Black Box Corporation. All rights reserved

2 Introduction

2.1 What is FSO?

FSO is free space optics provides point-point broadband communications using Laser Light as the transmission medium.

FSO is a state of art data communication method which is based on a very old communication solution. Ancient Chinese developed a protection system against the Mongol tribes, building watchtowers within the line of site to other towers. And as soon as the towers saw some hostile sign on the horizon they use they shield to reflect the sun to the remote towers. In this way the area could be prepared against the attack in a very short period of time.

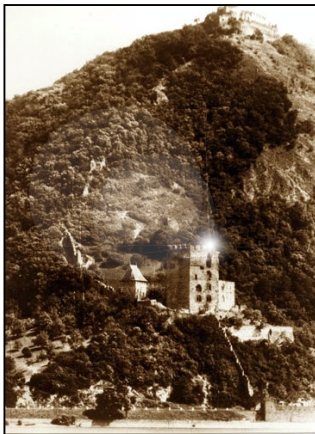

In the ancient times for this communication use the mirror as a transmitter and the sunlight was the light source, and the receiver was the remote guard's eye. This basic signalling method was developed later into up communication device which used „line coding“. This allowed the guards to tell the number of enemy, or the direction they are coming from.

Current **FSO** systems use a laser-diode as a light source, and a receptor diode (photo diode) to receive the signals coming from the laser diode from the transmitter side. But the basic elements are still the same: line of site between the communication nodes, and individual line coding. It is all about performance. **BlackBox** offers **FSO** systems with the highest power budget available on the market.

Why is it important?

Because of in the ancient Chinese times, the rain, the fog, or even the cloudy weather, could impact the operation of the whole system.

In the **FSO** units, comprising light source and receiver the cloud problem was solved, but development conditions still can impair performance. To go through the rain, the fog, or snow you need more and more power to be seen from the remote side. Achievable power levels are limited by a number of factors including eye safety.

In this way there is no other choice to see more than „training the eye“. Making the receiver more and more sensitive to sense light emitted from the remote side.

BlackBox offers high transmit power and also very hard



Copyright 2005. Black Box Corporation. All rights reserved

receiver sensitivity. These two factors combined to provide one of the best performing **FSO** systems on the market today.

This manual describes the **BlackBox** product of free space laser transmission system.

The **BlackBox** product offers cost effective reliable free space laser transmission for 100 Mbps data to the air, where a clean line of site is available. It delivers the most effective point-to-point connection between computer networks or telephone exchanges.

No need for installing cables, no rental costs, no licensing requirements.

Ideal for urban areas or city centres, where the use of these lines are expensive. Suitable for factories or industrial environments where high noise level can interfere with the transmitted data. The best choice to make a connection across rivers and other natural or artificial obstacles, where cable is not available.

The transmission technique used in the **BlackBox FSO** devices provides transparent and wire-speed data transfer with virtually zero latency. Because they use infrared light as the transmission medium, **BlackBox** system do not require frequency licenses and the transmission is not effected by electro-magnetic or radio-frequency interference. Basically the **BlackBox** link can be considered as a virtual fibre in the air, which ends in real fibre optic cable at both ends.

Our product is built using high quality components for operation in even the most adverse conditions.

Metal housing gives robust, waterproof environment for the electronics.

The shield protects the device from direct sunlight and provides extra air isolation.

The **BlackBox** systems comprise two laser-heads and the two indoor interconnection units (OIU) - one at each end. The interface connections are housed in the outdoor unit together with the PSU of the system.

Best practises were employed in cost engineering throughout the development of **BlackBox** .

Copyright 2005. Black Box Corporation. All rights reserved

2.2 Optical Free-space Transmission

The principle used in free space laser transmission is very similar to the one is used for fibre optic transmission. The difference is while fibre optic devices use electronics and optics optimized for transmission to the air. Also one can observe to the similarity in the transmission properties. No galvanic contact, no ground-loops, no need for surge protection, noise immunity, long distances, high bandwidth.

What makes it unique – and difficult to design – is that it does not require any transmission medium like fibre or copper, but it has to cope with the dynamically changing parameters. For instance while the attenuation of an optical fibre is constant, the attenuation of the atmosphere between the laser units can change dramatically (depending on the weather conditions).

The laser-heads are usually placed on top of building, where the clean line of site is guaranteed and the beam cannot be interrupted.

In the head the incoming signal is amplified, encoded, and then drives the laser-diode. The transmitter optics assures the proper beam shape and controls the beam divergence. The receive optics perceives and directs the transmitter signal to the photo diode. The diode converts it back into electrical, than it is decoded, amplified and converted.

There are several things that can influence the quality of transmission. We can classify those factors into three main groups.

System conditions - transmitting power, transmitter's wavelength, beam divergence, receiver optics diameter, receiver sensitivity, parameters of optical system and casing. These parameters determine the system's characteristic at a certain distance and are controlled by system design and factory set up.

Weather conditions - molecular absorption, particle scattering and turbulence. These elements have great effect on the operational conditions of the system. We do not have very much influence on them; proper product selection can eliminate the undesirable effects.

Environmental conditions - building movements, direct sunlight, refractive surfaces. These are also key factors related to the installation sites and can be controlled by appropriate site survey and system installation

Copyright 2005. Black Box Corporation. All rights reserved

2.3 Typical applications

Most typically the **BlackBox** is used to interconnect LAN-s. The system is protocol transparent, thus other applications also can be taken into consideration. Appropriate interface converters are needed and system bandwidth must be matched for that. Here we collected some circumstances, where the employment of the **BlackBox** is the most adequate and cost effective solution.

Those are:

Areas with natural or artificial obstacles



Where cable is actually not an alternative, like across rivers or railways or in rugged terrain.

Urban areas

Where only leased lines are available with limited speed, and high rental cost. With Black Box links you can establish on line LAN-to-LAN connections.



Industrial areas



Where you have noisy environment with high EMI or RFI. Factory buildings, airport objects can be connected through laser link.

ISP connections

Where high bandwidth is required. ISP's can offer high-speed links to their customers or trunks can be established between ISP's instead of expensive leased lines.

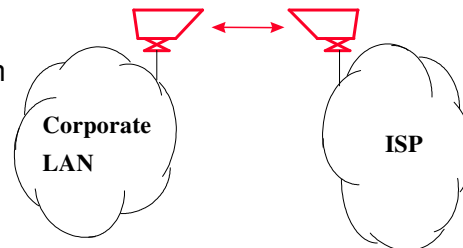

Copyright 2005. Black Box Corporation. All rights reserved



3 The product **BlackBox**

The **BlackBox** series products from **BlackBox** set a new standard for Free Space Optical transmission systems. They provide simple and easy to installation solution that is unique in laser based networking. This new range of products incorporates a lightweight, compact mechanical design with a factory-set optical system, which allows end-users to benefit from simple and quick installation. The **BlackBox** is more competitively priced than 2.4 GHz radio solutions and the bandwidth provided can be about ten times higher.

BlackBox range offers cost effective, reliable and secure laser based free space optical transmission for local area networks (LAN) at full duplex Fast Ethernet wire speed. The transmission carries data using a concentrated laser beam and a unique modulation technique is employed to ensure error free data transfer over distances of up to 200 meter. Transparent and wire speed data transfer together with virtually zero latency ensures that the **BlackBox** system can be easily integrated into any environment. The **BlackBox** series use laser light as a transmission medium. As with all **BlackBox** systems this means that frequency licenses are not required and transmission is not affected by electro-magnetic interference. The data transmission via a laser beam is secure as it is extremely hard to intercept, and cannot be detected by spectrum analysers. In the case of a **BlackBox** system the laser link is considered a "virtual" fibre in the air.

The **BlackBox** system comprises of two Laser Heads, two Outdoor Interconnection Units (OIU) and two sets of interconnection cables — one at each end. The Laser Heads are installed outdoors, usually on rooftops or sidewalls of buildings, where a clear optical path exists between the two sites. Next to the head the Outdoor Interconnection Unit provides fast and easy interconnection between the laser head and the cable coming from the network equipment. Moreover the OIU houses the Power Supply Unit (PSU) of the system and the network interface. The PSU provides the low voltage power required to operate the laser. Each **BlackBox** head contains built-in transmission monitoring service, which features a visual signal strength indicator and LINK status information accessible on the rear side of the head assembly through a window. In addition **BlackBox** units are equipped with optical aid to target the remote head easily. All that makes the installation real fast and easy even for people who have never dealt with FSO equipment before

By utilizing IEEE, and ITU standard compliant interfaces **BlackBox** system protects the customers' investments in long-term projects. Provides fast and easy connection for Fast-Ethernet, or PDH computer or telephone networks.

Copyright 2005. Black Box Corporation. All rights reserved

4 Content of the package

For the **BlackBox** systems **BlackBox** provides all the necessary accessories to fix the head to the bracket, fix the Power supply unit and the bracket to the wall, below you can see what is provided in the **BlackBox** package.



- 2ps of **BlackBox** heads
- 2ps of **BlackBox** **ODIUs** (Outdoor Interconnection Unit) /the two grey plastic boxes/
- ODIU accessories:
 - 2ps of 276x110x1,5 metal plates
 - 2x4ps of 6x40 spacers
 - 2x4ps of 6x15 spacers
 - 2x4ps of M6x70 flat sphere headed screws
 - 2x4ps of M5 nuts
 - 2x4ps of spring washers
 - 2x4ps of washers
 - 2x4ps of ø8x48 wall plugs
 - 2x4ps of M4,5x70 cross headed self-tapping-screws
- 2ps of mounting brackets for **BlackBox** heads /a camera consol like grey, metal appliances/
- a manual CD
- bracket accessories bag contents see below:
 - 2x3ps of M6x90 self-tapping-bolts
 - 2x3ps of ø10x80 wall plugs
 - 2x2ps of M6x90 tangent bolts (for vertical fine alignment)
 - 2x3ps of M6x25 bolts
 - 2x3ps of M6 nuts
 - 2x6ps of 6mm spring washers
 - 2x6ps of 6mm washers

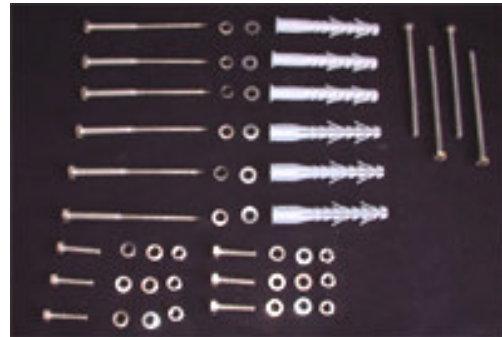

5 Sites of installation

5.1 Key factors of operation

There are four key issues that the site survey has to shed light on. Proper system operation cannot be guaranteed without satisfying all of the four requirements.

Clear line of sight - The entire optical path between the two ends must be free of any obstacles. It not only means that one has to see the other side, but other

Copyright 2005. Black Box Corporation. All rights reserved

possible sources of disturbance should also be taken into consideration. For example there might be turbulence above the roofs and other constructions, and this can cause fraction or scattering of the beam or snow accumulation on roofs too close to the beam can influence or even interrupt communication.

Solid mount surface - is the key for long-term operation. Since the diameter of the beam is limited, it is extremely important to mount the unit on a stable structure with the possible smallest movement. This way the receiver of the remote unit cannot get out of the beam due to the movement of the opposite head.

East-West orientation - although the receiver optics are equipped with optical filters to protect the receiver diode from the effect of undesired light sources, direct sunshine can cause saturation of the diode. This prevents the system from working properly for several minutes a day at certain times of the year. In most cases this effect can be avoided by careful selection of the mounting spot.

In order to comply with the requirements of the successful installation - including the discussed four key factors and other criteria - the following matters should be taken into consideration.

5.2 Preferred installation sites

All buildings and constructions have a certain movement of their own. It's determined by the structure and material of the building. Metal structures can shift or twist due to temperature changes. Wooden construction can expand or shrink with any changes in humidity. Give preference to concrete or brick buildings. On the other hand high structures like towers, skyscrapers or poles are always subject to movement. Mount the support frame to walls of the building or near corners, as they are the most stable spots. Use appropriate consoles for wall mounting. If a stand is used on the top of building, secure it directly to the ceiling or to the concrete cornice wherever is possible. Do not fix stands to insulating materials as they can slowly sink under the weight of the unit and with temperature changes. Big chimneys and smokestacks may look stable, but as their inner temperature varies they can also move. Vibration caused by heavy traffic, trains and elevators etc. may slowly move the system out of its specified direction. Another important consideration is to provide enough space for alignment and to have the potential for future maintenance.

Preferred installation sites	Pay attention to	Avoid (*)
Concrete wall	Behind window	Soft materials
Brick wall	Old constructs	Chimneys
	Microwave towers	Wooden constructs
		Metal masts or Frames
		Hidden heat isolations, like Styrofoam

(*)

Copyright 2005. Black Box Corporation. All rights reserved

In cases where installations are listed under "AVOID" cannot be avoided than special mounting accessories to be designed and special installations must be used.

It is not only the building that has to be solid, but the support structure too. Antenna poles and security camera holders are not suitable for the **BlackBox** units.

Copyright 2005. Black Box Corporation. All rights reserved

5.3 Direct sunshine

To prevent the sun shining directly into the receiver optics, first one has to determine the orientation of the link. Try to avoid East-West orientation wherever it is possible. Examine both sides of the link at sunset and sunrise and find a position where the sun cannot get behind any of the heads. Be aware that the path of the sun is changing throughout the year.

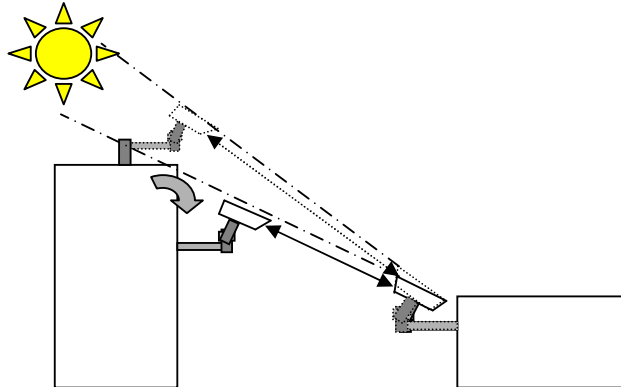

6 Eye safety

There are no two installation spots of the same kind, the buildings or structures, the available space and the accessibility of the place will be different in each case. Nevertheless, as a general rule it is very important to select the installation site so that nobody can look directly into the transmitter. For this reason place the head either so high (on the side wall of the building) or so close to the edge of the building (on a parapet on the rooftop) that no person can approach it accidentally and can get into the beam path. Set up barriers if necessary and put warning signs at prominent places.

The laser heads are provided with all labels and hazard warnings required by the laser standard. There are warning labels on both the left and right side of the protective cover next to the optical window and there is a warning and an informative label on the rear side of the laser head.

Copyright 2005. Black Box Corporation. All rights reserved

6.1 Mounting brackets for LWU1000s

Laserbit provides the following mounting bracket for **LWU1000**. A simple fixing technique of this bracket can be seen on the following figure, required tools are as follows:

- drilling machine
- 10mm wrench

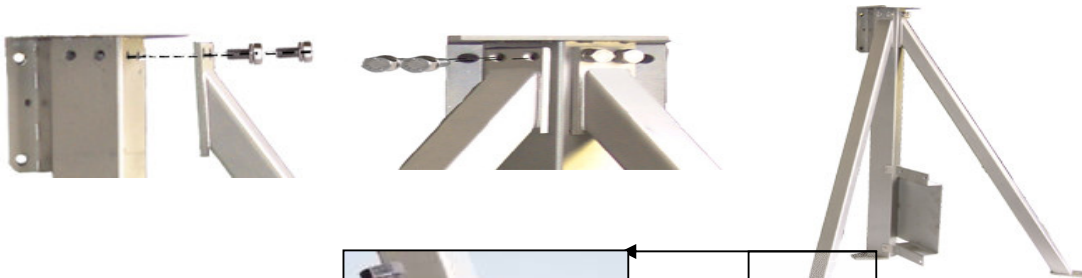

Bracket assemblage:

Using the provided M8x20 bolts attach the legs to the main mounting

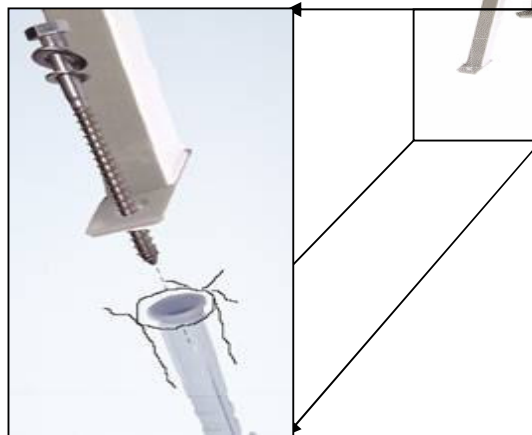

Installation steps:

- Place the bracket on the wall
- Mark the wall with a permanent marker
- Use your 12mm wall drill to drill all of the holes into the wall
- Clean the holes
- Place the wall-plugs into the holes (please note that some times you need to use hammer to put the wall-plugs into the hole, if you have to please be careful not to break the wall-plug)
- Place the bracket to the wall and line it up to the holes
- Put the screws into the wall-plug through the hole on the leg of the bracket (please see the figure above)

Copyright 2005. Black Box Corporation. All rights reserved

- Tighten up the screws

Copyright 2005. Black Box Corporation. All rights reserved

7 System installation

7.1 On the table test

Warning! Do not look either into the transmitter or the receiver optics because at this distance even the reflected laser beam *can* be dangerous to your eyes. Operating the system on much shorter distance than presumed originally can cause saturation or even permanent damage to the receiver. Always use optical attenuators for this kind of test.

The on-the-table test needs careful planning and careful use during the test period. The units should be placed at about 2 m distance from each other with optical windows facing one another. Put an appropriate optical attenuator (Attenuating foil or cardboard with several small holes) between the heads. Make all the necessary connection as described below to connect your network equipment (computer or protocol analyzer) to the heads and power up the units. Turn ON the Outdoor Interconnection Units and check if the power LED is ON on the head.

You should be able to align the units without any tool and get full received level on the signal strength LED's. Make sure that the "Saturation" indicator is OFF. Adjust your attenuators if necessary to avoid saturation of the receivers.

Please note that at this short distance, specially the longer distance links can reflect to the remote site or even to the same head. If you experience full receiving level, with no traffic throughput, in that case try to move the heads slightly units out of the reflection zone.



Please also take in consideration that the laser beam is concentrated and in such a short distance can harm your eyes, every time you test the units on short distance, do it with extra care. Never look into the sighting device if the remote laser is turned on. We strongly suggest to double check the power connection before you turn on the device. Handle the power connection with extra care. Safety first.

After obtaining the desired received level, check the data connection between devices. Using computers or appropriate testing devices.

On the table tests are perfect for troubleshooting (If there is a transmission problem, check the status of the connecting devices (e.g. Link signal or cable polarity) and

Copyright 2005. Black Box Corporation. All rights reserved

cables.) in a controlled area. If you experience some problems during the test, please try to test the connected equipments with a direct connection.

Copyright 2005. Black Box Corporation. All rights reserved

7.1.1 How can you install the ODIU?

Functionalities of the ODIU

The outdoor interconnection unit (ODIU) provides the power supply and data connection for the head. The power connection (+12VDC, GND, -12VDC).

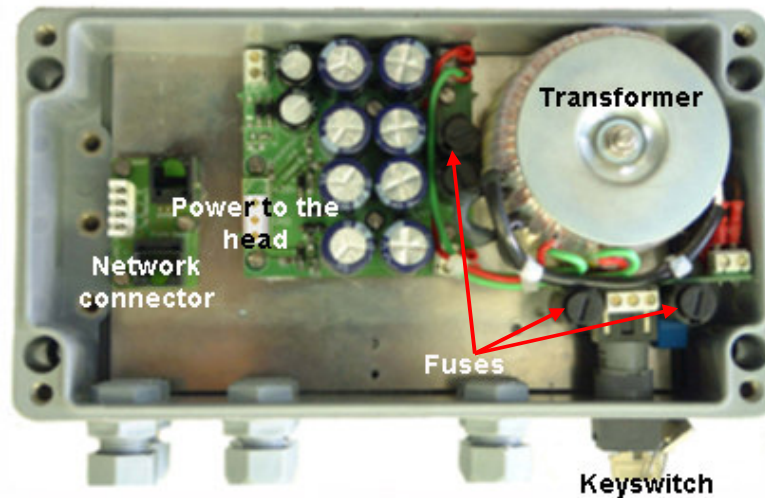

The ODIU made from poly-propylene enforced with fibre. This construction provides robust shock and waterproof environment (IP65) for the electrical devices.

The transformer is a not switch able transformer, so the main voltage must match to the one marked on the front cover. If the main power is different then this can damage the transformer.

In the ODIU there can be found four fuses, two for the transformer and the other two for the head.

Fuses

On the primarily side, the fuse ratings are: T0,8A (250V)

- in the case of glassheater the fuses are T1,6A (250V)

On the secondary side, the fuse ratings are: T6,3A (250V)

- in the case of glassheater the fuses are T6,3A (250V)

On the glassheater-panel the fuses are T6,3A (250V)

Copyright 2005. Black Box Corporation. All rights reserved

Installing the ODIU box

The physical fixing of the ODIU box can be seen below.

Necessary toolkit:

- Philips screwdriver
- 5mm wrench
- Drilling machine with an Ø8mm bit (the minimum effective length is 50mm)

First you have to fix the ODIU box to the metal plate:

- Pick the four M6x70 flat sphere headed screws, and take them to the holes on the corners of the box
- On the back of the box, where the screws came out, you have to put up the four 6x40 spacers (these are the longer ones) to the legs of the screws
- Pull on the metal plate to the legs of the screws
- Fix the metal plate with four M5 nuts using the four washers, and four spring washers like in the figure



Copyright 2005. Black Box Corporation. All rights reserved

Then you can fix the whole construction to a wall:

- Drill four holes, using the metal plate for measuring the places of the bores, with a $\varnothing 8\text{mm}$ bit. The depth of the bores have to be a minimum of 50mm
- Put the four wall-plugs into the four holes
- Put the four M4,5x70 cross headed self-tapping-screws through the four free holes of the metal plate
- Pull up the four 6x15 spacers (the shorter ones) to the screws
- Tight the screws into the wall-plugs, and tight it up as strong as possible for the appropriate fastening

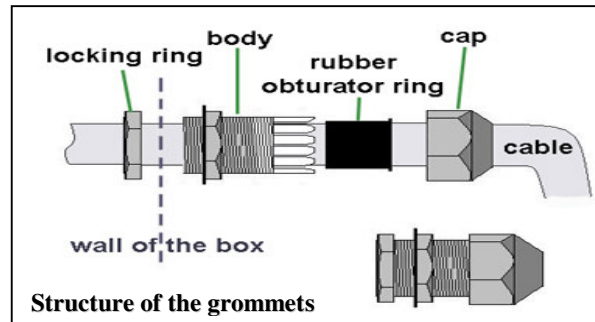

Connecting the head to the ODIU, and the ODIU to the power supply

Ensure that the cables are connected as it seen below.

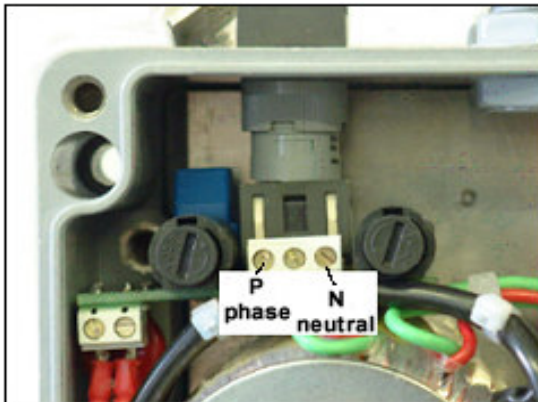

For the power connection recommended to use three-wired $\varnothing 0,75\text{mm}$ cables. The order of the connection can be seen on the figure.

- P – Phase
- N - Neutral

The necessary power can be supported to the head by the connector which can be seen in the figure next to this text. Order of the cables from the head: (the four-twisted-pair-wired cable)

- Red - +12V
- Black - -12V
- Twisted green-yellow - GND



Copyright 2005. Black Box Corporation. All rights reserved

7.1.2 Fixing the heads

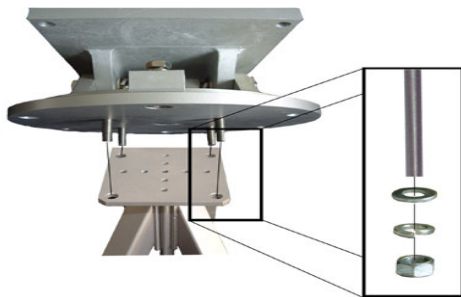

Your **LWU1000** head can be fixed to its stand with an alignment base unit(ABU). The ABU and its fixation to the stand can be seen on the left figure. The necessary nuts and washers can be found on the legs of the ABU.

On the right figure you can see an ABU, and a plinth of a **LWU1000** unit, and the necessary fixing parts. The necessary nuts and washers can be found on the legs of the head. The steps of the fixing are:

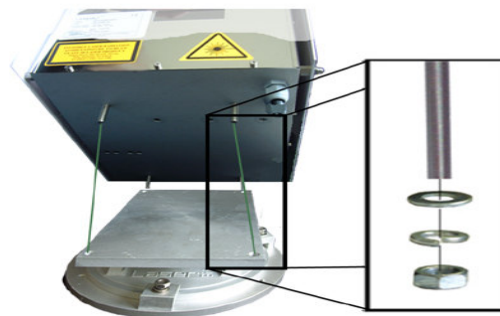

- First, place the ABU to the stand
- Fix the ABU to the stand using the washers and nuts
- Place the head to the ABU
- Fix the bolts with the nuts, using the washers

7.1.3 Alignment of the heads



- Target Side B with the crosshair built in to the head on Side A
- Repeat the first step with Side B!
- Power up the heads!
- Screw the three nuts up tight on both heads, which are used for the horizontal fixation, but be careful that the heads do not move out from its position!
- Screw the two nuts up tight on both heads, which are used for the fixing the vertical direction, but be careful that the heads do not move out from its position!

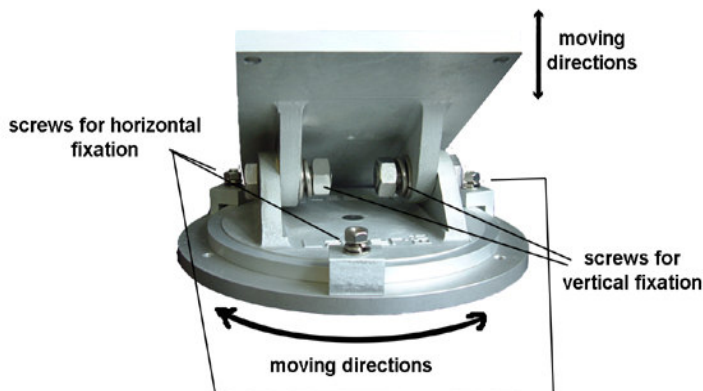

Copyright 2

reserved

Meaningsofthe LEDs

Power:

The head is powered up.

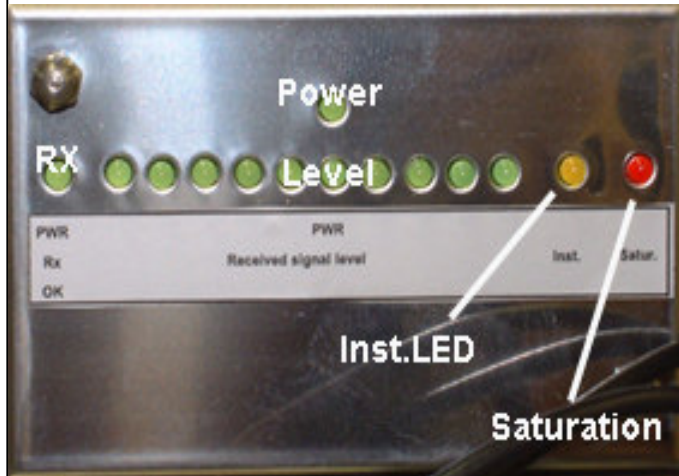

RX OK:

There is enough light to start communicate through the link.

Level LEDs:

The function of these10 green LEDs is to give visual information about the incoming light efficiency

Installation LED:

It signs you have the biggest amount of incoming light efficiency which is still not overloads the receiver

Saturation:

Overload (Overloading can cause stop in the communication, and permanently it can damage the receiver)

After 15mW (or higher) incoming light efficiency

- After the heads are lined up with the sighting device, you have lined the units into a negligent position
- Following the LED's you might require some fine alignment with the spacers which you can see in the figure! Depending on the distance this can be small or large movements.
/Please note the larger the distance the less movements are required for the fine alignment/
- The Fine adjustments should be done as follows
 - 1 Place the two spacers where the figure shows to.

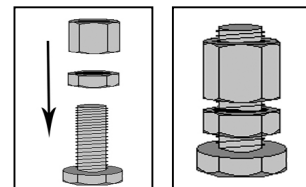

Copyright 2005. Black Box Corporation. All rights reserved

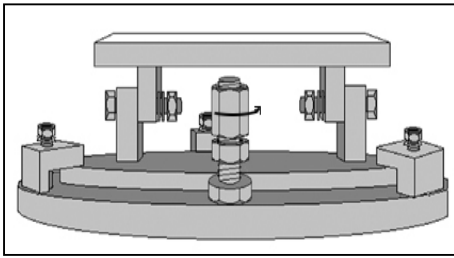

Open the spacers until it reaches the bottom of the upper plate of the ABU. Repeat this on the back side too.

- 2 With these spacers you can manipulate the vertical state of the head and necessary the beam too.

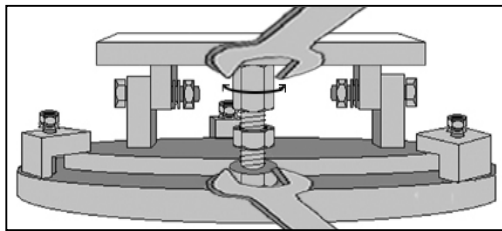

For the fine adjustment you need two wrenches. With one of them you have to hold the head of the bolt, and with the other you can turn the thick nuts to lift or loose the plate of the ABU.

- 3 Important to take note that both of the spacer have to fastened tight.

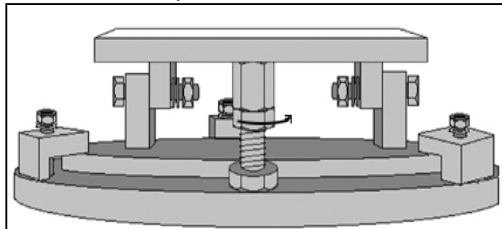

To not enable any movement on the vertical angle of the head and due to the heat expansion please close the locking nut under the thick nut, as it shown on the figure, on both sides

- Repeat the steps 1-3 on the remote end as well.
- Now the system is secured with the fine adjustment bolts. The long term alignment bolts should be tightened on the bottom of the unit.
/Please note: During the tightening process should you experience some movements. This should be compensated with further tightening of the fine adjustment bolts/

Copyright 2005. Black Box Corporation. All rights reserved

7.1.4 Connecting to your Network

If you have a TP head

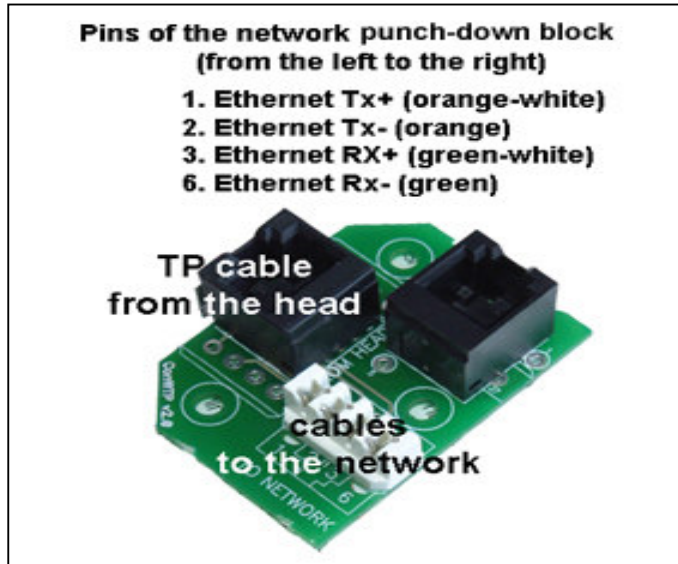

You can find a TP connector unit in your ODIU, with these connectors. You have to plug in the TP cable of your head into the RJ45 connector. Your network is connectable to the LB system using the white one rowed connector, where you have to connect the four cable of your network with the help of the punch down tool. The order of the cable can be seen on the figure.

The punch-down tool

Place your first cable on the top of the chosen connector, without removing the insulator from the cable. Then using the punch down tool push down the cable into the connector.

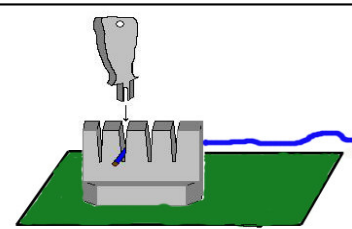

If you have a TC head

You can find a two sided fibre connector in your ODIU. You have to connect the fibre cable of your head into the one side of the connector, and into the other side you have connect the fibre cable of you network equipment (switch; router or LB combiner).

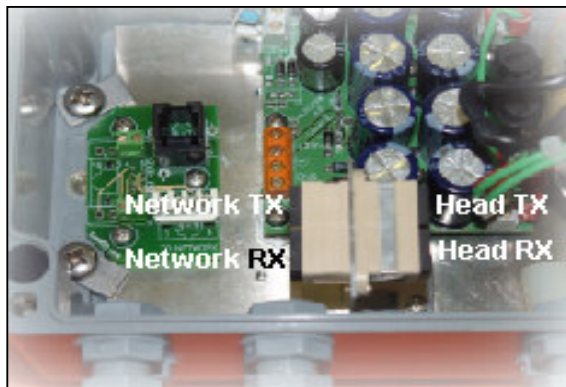

The fibre plugs of the heads are always SC typed, which means that them cross-sections are cubic form. The fibre connector in the ODIU is SC-SC typed, so you have to provide an SC fibre plug for you network. The SC-SC connector is a reversible part, so you can connect in the first plug where you

want, the important is that the two plugs of the head have to be on one side, and the two plugs of the network have to be on the other, and if you plug in the transmitter

Copyright 2005. Black Box Corporation. All rights reserved

side of the head into a connector, then the transmitter side of the network have to be in the opposite connector of the previous, and do the same with the other sides too.

7.1.5 Connecting to the management

If you have a TP head

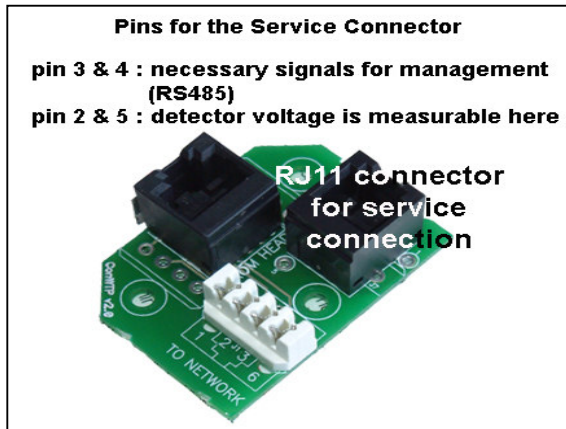

Using the RJ11 Service Connector you can connect your management indoor unit to the head.

More details about the management please find to see its own Users' Manual.

If you have a TC head

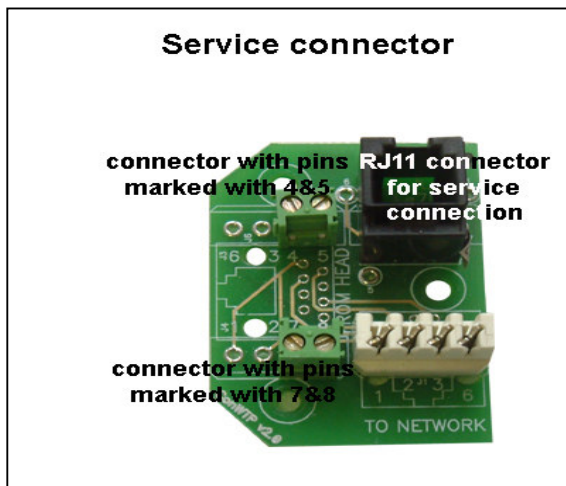

Using the RJ11 Service Connector and the two green connectors you can connect your management indoor unit to the head.

The necessary signals can be found on the blue and brown wires of the head power cable. You have to connect these two wires into two pins of the four of the two green connectors. These pins are connected to the pins of the RJ11 Service Connector. The order of connections is the following:

Pin of the green connector	4	5	7	8
Pin of the RJ11 Service Connector	4	5	3	2

More details about the management please find to see its own Users' Manual.
 (please connect the blue and the brown wires to the Pin number 4&7 in case of The Web-Based LB-View MGM unit)

Copyright 2005. Black Box Corporation. All rights reserved

7.2 Outdoor interconnection unit with Heater

As an optional glass heater can be ordered for the link, the idea is the same what is used for the cars back window heater. This automated heater turns on and removes the ice from the front window only below 5 °C(±2°C). It turns of only if the temperature goes above 10°C. If the heater is in use you will see a small yellow LED lighting on the power circuit board.



Slot(top to bottom)	Colour code
+ PSU in(Factory preset)	Black
- PSU in(Factory preset)	Black
Sensor1	Black
Common	Black
Sensor2	Not connected
Output for Heater	Blue
GND	Brown

Three versions exist depending on the system configuration. There are no differences in the connection can be seen below. J1 terminal block is the power connector for the heater panel. This can be depending on the version 12VAC, 12VDC, or 8,5VDC. This panel senses the temperature based on the sensor glued to the front window, and turns on the glass heater or turns it off. The sensor is connected with two black wires to J3 as it can be seen on the picture. The connection is simple connect one of the black wires into the middle slot on J3 and the other one right next to it to Sensor 1. The polarity doesn't make any difference, in the operation. Please note that one of the black wires must be connected into the middle slot on J3.

The heating voltage is connected to J2 with a Blue and a Brown cable, this voltage is switched automatically by the PCB. The glass heater unit is optional for the entire product range, except for the PICO(not available). The ODIU size is bigger in case of the Pinto, LWU1000, GigaPico, Giga Pinto, GigaLWU1000. The size of the outdoor unit 53x100x31(43)mm.

Copyright 2005. Black Box Corporation. All rights reserved

The 12VDC and the 8,5VDC systems are available only for the 48VDC power supply.

Copyright 2005. Black Box Corporation. All rights reserved

7.3 48 VDC Power supply connections

In fact the 48VDC power supply is optional, the connection is almost the same. In the case of the 48VDC power supply it is important to pay attention to the polarities.

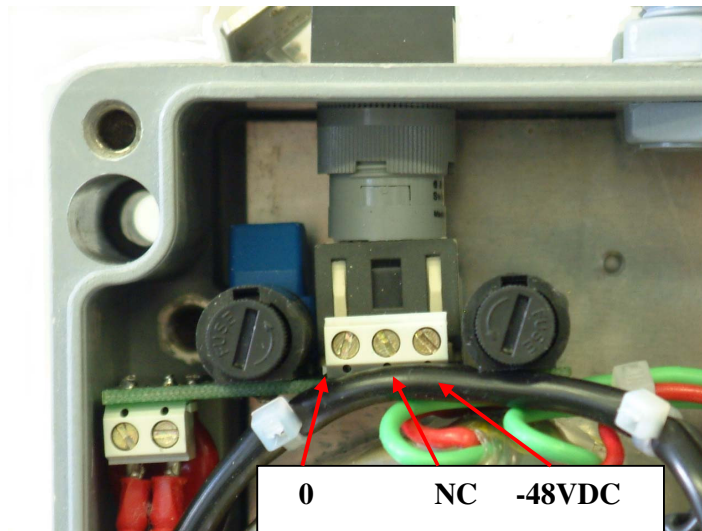

The wrong polarity of the cables can damage the power supply.

In this type of ODIU you can find fuses only on the primary side of the transformer.

Type	PINTO	LWU1000
fuse	T6,3A(250V)	T6,3A(250V)

In this case you should connect your negative 48V point to the N point of the OIU, and your GND should be connected to the P point.

In this case you have the 3 poles connector for the head power supply for every type of heads. So the connecting order is as follows, which must be followed:

Color coding Pinto:

Green	positive
Twisted: orange-White, Green-White	GND
Orange	negative

Color coding LWU1000:

Red	positive
Green-Yellow	GND
Black	negative



Copyright 2005. Black Box Corporation. All rights reserved

8 Warranty conditions

BlackBox warrants that the **BlackBox** product purchased will free from defects in material and workmanship for a period of one (1) year from the date of purchase. This warranty period will not be extended by virtue of a repair of the product or a replacement of any component of the product during the warranty period.

This warranty covers only normal commercial use. **BlackBox** is not responsible for warranty service should the **BlackBox** identification marks, serial numbers or original seals be removed, altered, or broken, or should the product fail to be properly maintained or fail to function properly as a result of any modification, misuse, abuse, improper installation, neglect, improper shipping, damage caused by disasters such as fire, flood, earthquake or lightning, improper electrical current, or service other than by **BlackBox** or its authorised partners.

If the **BlackBox** product fails to operate as warranted at any time during the warranty period, **BlackBox** will repair, or at its option, replace the defective product at no additional charge.

In no event will **BlackBox** be liable for any damages including loss of data, lost profits, lost savings, lost business, or other incidental or consequential or indirect damages arising out of the installation, use, maintenance, performance, failure or interruption of the **BlackBox** product, even if **BlackBox** has been advised of the possibility of such damage.

The purchaser or user shall have the responsibility to give **BlackBox** prompt written notice of any warranty claims. If the product was purchased through an authorised partner of **BlackBox**, notice may be given in writing to that authorised partner in the area in which the product was being used.

The product may be returned to **BlackBox** only if it has a Return Material Authorisation (RMA) number. The product must be shipped prepaid, insured and in the original shipping package or similar package for safe shipment. The RMA number must be marked on the outside of the shipping package. Any product returned without an RMA number shall be rejected.

Transportation charges for the return of the product will be paid by **BlackBox** if it is determined by **BlackBox** that the product was defective within the terms of the warranty; otherwise the purchaser or user shall be responsible for costs of return handling and transportation.

If the **BlackBox** product does not operate as warranted above, the customer's sole remedy shall be repair or replacement. The foregoing warranties and remedies are exclusive and are in lieu of all other warranties, expressed or implied, either in fact or by operation of law, statutory or otherwise, including warranties of merchantability and fitness for a particular purpose. **BlackBox** neither assumes nor authorises any

Copyright 2005. Black Box Corporation. All rights reserved

other person to assume for it any other liability in connection with the sale, installation, use or maintenance of the product.

Copyright 2005. Black Box Corporation. All rights reserved

9 Appendix A

a. Product registration form

Please take your time to fill out **Black Box** product registration form to ensure your warranty period begins, otherwise **Black Box** consider warranty beginning from the date of shipment from **Black Box**.

 BLACK BOX FIELDWORK SERVICES		Product Registration Form	
Customer Name		Contact Name:	
Address		Tel.:	
		Fax.:	
		Email:	
Link Information			
Link type	LB-	-	
S/N 1		S/N 2	
OUI Information: H104 5 0000 0000 8 0000			
S/N 1		S/N 2	
Description of Installation			
Connecting devices		S06 A	S06 B
Detector voltages			
Beam Diameter: INCHES			
Installation Distance	Installation date	Duration of Installation	
Installation done by	Company name	Phone Nr.:	
		Email:	
		Fax Nr.:	

Copyright 2005. Black Box Corporation. All rights reserved

b. Failure report form

In case of failures please report it to the **BlackBox**, with filling out the failure report form and forward it to the **BlackBox**!

 BLACK BOX <small>NETWORK SERVICES</small>		Failure Report Form	
Customer Name: _____		Contact Name: _____	
Address: _____		Tel.: _____	
		Fax: _____	
		E-mail: _____	
Link Information: _____			
Link type: _____			
S/N 1: _____		S/N 2: _____	
ONU Information: _____			
S/N 1: _____		S/N 2: _____	
Description of the Failure: _____ _____ _____ _____			
Date of failure: _____		Date of Failure report: _____	
<small>Please Observe and please do not write into the section below</small>			
Failure report Nr: _____		Issued by: _____	
Issue Date: _____			

Copyright 2005. Black Box Corporation. All rights reserved