



© Copyright 2001. Black Box Corporation. All rights reserved.

---

*1000 Park Drive • Lawrence, PA 15055-1018 • 724-746-5500 • Fax 724-746-0746*



# Net Access Broadband Router w/4-Port Switch Users' Manual

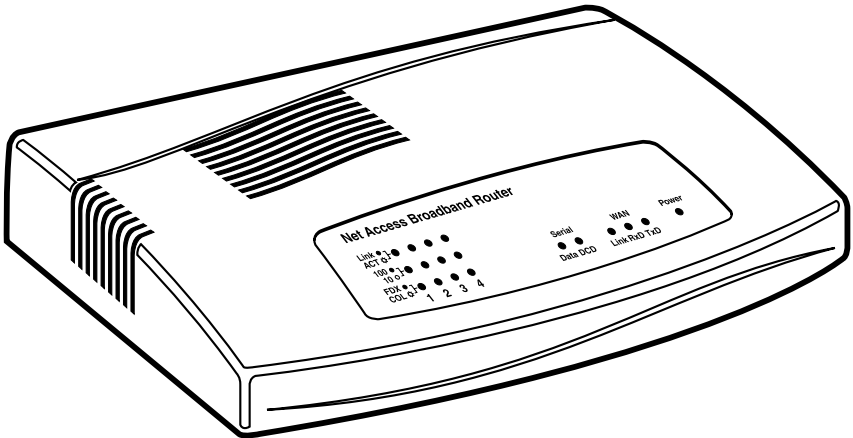

**CUSTOMER  
SUPPORT  
INFORMATION**

Order toll-free in the U.S.: Call **877-877-BBOX** (outside U.S. call **724-746-5500**)  
FREE technical support 24 hours a day, 7 days a week: Call **724-746-5500** or fax **724-746-0746**  
Mailing address: **Black Box Corporation**, 1000 Park Drive, Lawrence, PA 15055-1018  
Web site: [www.blackbox.com](http://www.blackbox.com) • E-mail: [info@blackbox.com](mailto:info@blackbox.com)



FEDERAL COMMUNICATIONS COMMISSION  
and INDUSTRY CANADA  
RADIO FREQUENCY INTERFERENCE STATEMENTS

**Class B Digital Device.** This equipment has been tested and found to comply with the limits for a Class B computing device pursuant to Part 15 of the FCC Rules. These limits are designed to provide reasonable protection against harmful interference in a residential installation. However, there is no guarantee that interference will not occur in a particular installation. This equipment generates, uses, and can radiate radio frequency energy, and, if not installed and used in accordance with the instructions, may cause harmful interference to radio communications. If this equipment does cause harmful interference to radio or telephone reception, which can be determined by turning the equipment off and on, the user is encouraged to try to correct the interference by one of the following measures:

- Reorient or relocate the receiving antenna.
- Increase the separation between the equipment and receiver.
- Connect the equipment into an outlet on a circuit different from that to which the receiver is connected.
- Consult an experienced radio/TV technician for help.

**Caution:**

**Changes or modifications not expressly approved by the party responsible for compliance could void the user's authority to operate the equipment.**

To meet FCC requirements, shielded cables and power cords are required to connect this device to a personal computer or other Class B certified device.

*This digital apparatus does not exceed the Class B limits for radio noise emission from digital apparatus set out in the Radio Interference Regulation of Industry Canada.*

*Le présent appareil numérique n'émet pas de bruits radioélectriques dépassant les limites applicables aux appareils numériques de classe B prescrites dans le Règlement sur le brouillage radioélectrique publié par Industrie Canada.*

**NORMAS OFICIALES MEXICANAS (NOM)  
ELECTRICAL SAFETY STATEMENT**

**INSTRUCCIONES DE SEGURIDAD**

1. Todas las instrucciones de seguridad y operación deberán ser leídas antes de que el aparato eléctrico sea operado.
2. Las instrucciones de seguridad y operación deberán ser guardadas para referencia futura.
3. Todas las advertencias en el aparato eléctrico y en sus instrucciones de operación deben ser respetadas.
4. Todas las instrucciones de operación y uso deben ser seguidas.
5. El aparato eléctrico no deberá ser usado cerca del agua—por ejemplo, cerca de la tina de baño, lavabo, sótano mojado o cerca de una alberca, etc..
6. El aparato eléctrico debe ser usado únicamente con carritos o pedestales que sean recomendados por el fabricante.
7. El aparato eléctrico debe ser montado a la pared o al techo sólo como sea recomendado por el fabricante.
8. Servicio—El usuario no debe intentar dar servicio al equipo eléctrico más allá a lo descrito en las instrucciones de operación. Todo otro servicio deberá ser referido a personal de servicio calificado.
9. El aparato eléctrico debe ser situado de tal manera que su posición no interfiera su uso. La colocación del aparato eléctrico sobre una cama, sofá, alfombra o superficie similar puede bloquea la ventilación, no se debe colocar en libreros o gabinetes que impidan el flujo de aire por los orificios de ventilación.
10. El equipo eléctrico deber ser situado fuera del alcance de fuentes de calor como radiadores, registros de calor, estufas u otros aparatos (incluyendo amplificadores) que producen calor.
11. El aparato eléctrico deberá ser conectado a una fuente de poder sólo del tipo descrito en el instructivo de operación, o como se indique en el aparato.

12. Precaución debe ser tomada de tal manera que la tierra física y la polarización del equipo no sea eliminada.
13. Los cables de la fuente de poder deben ser guiados de tal manera que no sean pisados ni pellizcados por objetos colocados sobre o contra ellos, poniendo particular atención a los contactos y receptáculos donde salen del aparato.
14. El equipo eléctrico debe ser limpiado únicamente de acuerdo a las recomendaciones del fabricante.
15. En caso de existir, una antena externa deberá ser localizada lejos de las líneas de energía.
16. El cable de corriente deberá ser desconectado del cuando el equipo no sea usado por un largo periodo de tiempo.
17. Cuidado debe ser tomado de tal manera que objetos líquidos no sean derramados sobre la cubierta u orificios de ventilación.
18. Servicio por personal calificado deberá ser provisto cuando:
  - A: El cable de poder o el contacto ha sido dañado; u
  - B: Objetos han caído o líquido ha sido derramado dentro del aparato; o
  - C: El aparato ha sido expuesto a la lluvia; o
  - D: El aparato parece no operar normalmente o muestra un cambio en su desempeño; o
  - E: El aparato ha sido tirado o su cubierta ha sido dañada.

## TRADEMARKS USED IN THIS MANUAL

DEC™ is a trademark of Digital Equipment Corporation.

Intel® is a registered trademark of Intel Corporation.

IPX™ is a trademark and Novell® and NetWare® are registered trademarks of Novell Incorporated.

Microsoft®, Windows®, and Windows NT® are registered trademarks of Microsoft Corporation.

UL® is a registered trademark of Underwriters Laboratories Incorporated.

Unix® is a registered trademark of UNIX System Laboratories, Inc.

Xerox® is a registered trademark of Xerox Corporation.

*Any other trademarks mentioned in this manual are acknowledged to be the property of the trademark owners.*

# Contents

<b>Chapter</b>	<b>Page</b>
1. Specifications . . . . .	9
2. Introduction . . . . .	10
2.1 Front Panel . . . . .	11
2.2 Back Panel . . . . .	12
2.3 Typical Applications . . . . .	14
2.3.1 Connecting a Remote Site via a Cable Modem . . . . .	14
2.3.2 Connecting a Local Site by Segmenting the LAN . . . . .	15
2.3.3 Connecting a Local Site to the Internet . . . . .	15
3. Hardware Installation . . . . .	17
3.1 Safety . . . . .	17
3.2 What the Package Includes . . . . .	17
3.3 Cabling . . . . .	18
4. Software Installation and Configuration . . . . .	20
4.1 Software Installation . . . . .	20
4.2 Using the Setup Wizard . . . . .	21
4.3 Testing Your Connection . . . . .	36
5. Telnet . . . . .	38
5.1 Starting a Telnet Session . . . . .	38
5.2 Using the Telnet Server Menu . . . . .	39
6. Broadband Manager . . . . .	49
6.1 General Settings . . . . .	50
6.1.1 LAN Ethernet Segment . . . . .	51
6.1.2 WAN Ethernet Segment . . . . .	51
6.1.3 Async Port . . . . .	52
6.2 Port Settings . . . . .	62
6.2.1 Edit Login for Remote Access . . . . .	63
6.2.2 Modem String Settings . . . . .	67
6.2.3 Dial-Up/Hang-Up Settings . . . . .	68
6.3 LAN DHCP Server . . . . .	69
6.3.1 IP Address Pool . . . . .	70
6.3.2 IP Address Mapping Reservation . . . . .	70
6.4 Routing Settings . . . . .	71
6.5 Filter Settings . . . . .	74



# Contents (continued)

Chapter	Page
6.6 Refresh Device List . . . . .	79
6.7 Device Name and Password . . . . .	79
6.8 Save Settings to File . . . . .	80
6.9 Load Settings . . . . .	81
6.10 Upgrade Firmware . . . . .	82
6.11 General Diagnostic . . . . .	83
<b>7. Router Monitor . . . . .</b>	<b>85</b>
7.1 Running Router Monitor . . . . .	85
7.2 Refresh Device List . . . . .	85
7.3 Test Connection . . . . .	86
7.4 Terminate Connection . . . . .	87
7.5 Save to File . . . . .	87
7.6 IP Address/Name . . . . .	89
7.7 Event Messages . . . . .	90
7.8 TCP/IP Tab . . . . .	90
7.9 Time Tab . . . . .	91
7.10 Status Tab . . . . .	92
7.11 Statistics Tab . . . . .	93
<b>8. LAN Client Settings . . . . .</b>	<b>95</b>
8.1 Setting Up Remote Access Clients . . . . .	95
8.2 Accessing a Windows NT Server . . . . .	96
8.2.1 Adding the Dial-Up Adapter (NT Server Connection) . . . . .	96
8.2.2 Adding TCP/IP (NT Server Connection) . . . . .	97
8.2.3 Adding Client for Microsoft Network (NT Server Connection) . . . . .	97
8.2.4 Adding File and Print Sharing for Microsoft Networks (NT Server Connection) . . . . .	97
8.2.5 Set Your Primary Network Logon (NT Server Connection) . . . . .	98
8.2.6 Set-Up Properties of Components (NT Server Connection) . . . . .	98
8.2.7 Make Your New Connection (NT Server Connection) . . . . .	99
8.2.8 Set Dial-Up Type (NT Server Connection) . . . . .	100
8.2.9 Dial Into Your Network (NT Server Connection) . . . . .	100
8.3 Accessing a Novell Server . . . . .	100
8.3.1 Adding the Dial-Up Adapter (Novell Server Connection) . . . . .	101
8.3.2 Adding IPX/SPX (Novell Server Connection) . . . . .	101

# Contents (continued)

Chapter	Page
8.3.3 Adding Client for NetWare Networks (Novell Server Connection) . . . . .	102
8.3.4 Set-Up Properties of Components (Novell Server Connection) . . . . .	102
8.3.5 Set Your Primary Network Logon (Novell Server Connection)	103
8.3.6 Set Your Access Control (Novell Server Connection) . . . . .	103
8.3.7 Make Your New Connection (Novell Server Connection) . . . . .	103
8.3.8 Set Dial-Up Type (Novell Server Connection) . . . . .	104
8.3.9 Dial Into Your Network (Novell Server Connection) . . . . .	104
8.4 Accessing a Windows NT Server and a Novell NetWare Server . . . . .	105
8.4.1 Adding the Dial-Up Adapter and a Novell NetWare Server . . . . .	105
8.4.2 Adding TCP/IP (Novell/NT Server Connection) . . . . .	105
8.4.3 Adding Client for Microsoft Networks (Novell/NT Server Connection) . . . . .	106
8.4.4 Adding File and Print Sharing for Microsoft Networks (Novell/NT Server Connection) . . . . .	106
8.4.5 Adding IPX/SPX (Novell/NT Server Connection) . . . . .	106
8.4.6 Adding Client for NetWare Networks (Novell/NT Server Connection) . . . . .	107
8.4.7 Set Your Primary Network Logon (Novell/NT Server Connection) . . . . .	107
8.4.8 Set-Up Properties of Components (Novell/NT Server Connection) . . . . .	107
8.4.9 Make Your New Connection (NT/Novell Server Connection) . . . . .	109
8.4.10 Set Dial-Up Type (NT/Novell Server Connection) . . . . .	110
8.4.11 Dial Into Your Network (NT/Novell Server Connection) . . . . .	110
8.5 Accessing a Unix Server . . . . .	111
8.5.1 Adding the Dial-Up Adapter (Unix Server Connection) . . . . .	111
8.5.2 Adding TCP/IP (Unix Server Connection) . . . . .	111
8.5.3 Set-Up Properties of Components (Unix Server Connection) . . . . .	112
8.5.4 Make Your New Connection (Unix Server Connection) . . . . .	112
8.5.5 Set Dial-Up Type (Unix Server Connection) . . . . .	113
8.5.6 Dial Into Your Network (Unix Server Connection) . . . . .	113
8.6 Make New Connection (Windows 2000 Only) . . . . .	113

# Contents (continued)

<b>Chapter</b>	<b>Page</b>
9. LAN-to-LAN Settings . . . . .	115
9.1 Setting Up a Windows Machine to Share Files . . . . .	115
9.2 Using the Find Computer Command . . . . .	116
9.3 Using LMHosts . . . . .	116
10. Troubleshooting . . . . .	118
10.1 Problems/Solutions . . . . .	118
10.2 Calling Black Box . . . . .	122
10.3 Shipping and Packaging . . . . .	123
Appendix A: Tools for Your Router . . . . .	124
A.1 Broadband Monitor . . . . .	124
A.2 PING . . . . .	124
A.3 WINIPCFG and IPCONFIG . . . . .	124
A.4 TRACERT . . . . .	125
Appendix B: Cabling Diagrams . . . . .	126
B.1 WAN/LAN Cables . . . . .	126
B.2 Serial Cable . . . . .	127
Appendix C: Glossary . . . . .	128

# 1. Specifications

**LAN Ports:** *Number of Ports:* 4; *Interface:* 10BASE-T/100BASE-TX, one can be used for uplink; *Standards:* IEEE 802.3

**WAN Ports:** (1) 10BASE-T, (1) RS-232 (V.24); *DTE Speed:* Up to 460 kbps asynchronous

**Protocols:** *Security:* PAP/CHAP, MSCHAP, NAT Firewall, RADIUS and Callback for remote access; *Network:* TCP/IP, IPX, DHCP, PPP, PPPoE; *Routing:* Static, RIP1, VPN, IPSec, PPTP pass-through; *Filtering:* Protocol, port number, URL address, and IP address

**Processor:** 40-MHz, 32-bit RISC

**Memory:** *RAM:* 4 MB; *Flash ROM:* 512 KB

**Operating Temperature:** 32 to 120°F (0 to 50°C)

**Humidity:** 25 to 85% noncondensing

**Approvals:** FCC Part 15, Class B

**Power:** 5 VDC, 1000 mA

**Size:** 4.9"H x 7.1"W x 1.4"D (12.5 x 18 x 3.6 cm)

**Weight:** 13 oz. (370 g)

## 2. Introduction

The Net Access Broadband Router w/4-Port Switch connects a DSL or cable modem to an Ethernet LAN to provide high-speed broadband access to the Internet for multiple users. The Router features a built-in 4-port 10/100 switch, one asynchronous port for backup Internet access or dial-in remote access, and firewall services. The Router is ideal for any business looking for cost-effective broadband access to the Internet for every use on the LAN or for the home user looking to share their DSL cable modem.

The Router connects up to 253 internal IP addresses to the Internet with broadband speed. It can be configured as a DHCP server to handle requests for Internet services and route to and from the ISP. Up to 253 internal IP addresses are connected to the Internet with only one IP account. The WAN Ethernet port has a bandwidth of 10 Mbps, which is 179 times faster than a 56-kbps modem and can support DSL or cable speeds of up to 2.5 Mbps.

A built-in 10/100-Mbps Switch is included with the router. The integrated 4-port 10/100 switch eliminates the need for an additional hub or switch to connect users not on a LAN. It ensures high-speed transmission and can serve as a completely dedicated full duplex backbone.

The Router gives you network security. It uses the NAT protocol to provide security from hackers attempting to access the office LAN without the extra cost of a firewall. It implements firewall and gateway security for LAN-based resources. The Router also supports Internet access restriction by IP address, client protocols, or a list of forbidden sites.

The Router features Dial Backup or Dial-in RAS Port. It also provides an additional asynchronous port that, when connected to a dial-up modem or ISDN terminal adapter, serves as a backup resource for Internet access if your DSL or cable service goes down. It can also serve as dial-in remote access for your telecommuters or mobile users.

Plus, it offers Virtual Server Support. In addition to providing shared Internet access, the Router can support Web, FTP, or other Internet servers. Once configured, the Router accepts only unsolicited IP packets addressed to the Web or FTP server.

LAN segmentation is included with the Router. For added LAN security, you can use the Router to segment the LAN by connecting the corporate servers to one Router Ethernet port and the Internet servers to the other Ethernet port. This configuration puts the corporate servers behind a firewall and the Internet servers

outside the firewall. To continue to provide Internet access, connect a modem or ISDN terminal adapter to the Router's asynchronous port.

### 2.1 Front Panel

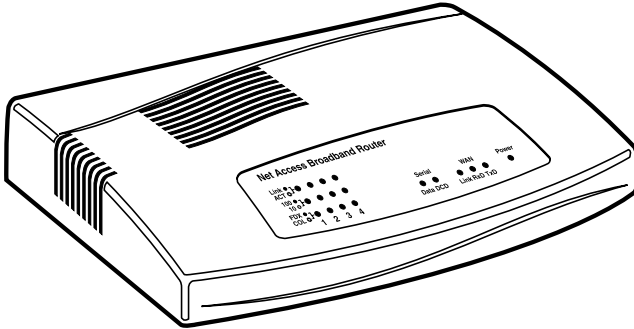

Figure 2-1. Front panel.

Table 2-1. Front-panel indicators.

LED Group	LED	Description
LAN	Link/Act	Lights when the LAN client is correctly connected to the 10BASE-T Ethernet LAN.
	10/100	Lights when the LAN client correctly establishes a 100-Mbps connection.
	FDX/COL	A steady-on light indicates a successful LAN connection. A flickering light indicates a potential network connection problem.
Serial	Data	Blinks when the serial async port is receiving or transmitting data.
	DCD	Lights when the serial async port is properly connected to a remote site.

**Table 2-1 (continued). Front-panel indicators.**

LED Group	LED	Description
<b>WAN</b>	Link	Lights when a successful connection to the 10BASE-T WAN is established.
	RXD	Lights when the LAN port is receiving data.
	TXD	Lights when the LAN port is transmitting data.
<b>Power</b>	PWR	Lights when power is being supplied to the router.

**2.2 Back Panel**

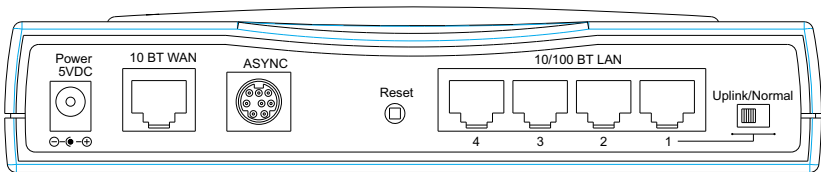

**Figure 2-2. Back panel.**

**Table 2-2. Back panel connectors/buttons.**

Connector/Button	Description
<b>Power 5VDC</b>	The 5-VDC power socket is used to connect the device to the AC power adapter.
<b>10 BT WAN</b>	The WAN port is used to connect the router to a DSL or cable modem.
<b>ASYNC</b>	The serial async port connects the router to a standard modem (optional).
<b>Reset</b>	The reset button is used to reset the router to factory defaults.
<b>10/100 BT LAN</b>	The four 10/100 ports are used to connect the router to LAN client workstations. If the Router is set to use the Uplink feature, the number 1 LAN port is inactive as a LAN port.
<b>Uplink/Normal</b>	Slide the switch to the Uplink position to use the number 1 LAN 10/100 port to expand your network by connecting a network cable to another router, switch, or hub. To connect the number 1 port to a LAN client workstation, slide the switch to the Normal position.



## 2.3 Typical Applications

The following examples provide information about typical applications using the Router. They describe using the Router to connect a remote site via a cable modem, using the Router to segment a local area network, and using the Router to connect a LAN to the Internet using one shared IP address.

### 2.3.1 CONNECTING A REMOTE SITE VIA A CABLE MODEM

In the following example, the Router is used to connect a LAN to the Internet via DSL or a cable modem.

Kernal: (outgoing TCP/IP connection sharing a single Internet IP address or using multiple IP mapping)

- Virtual Server (allowing incoming specific TCP/IP service request redirect to an internal server)
- Static Routing (Routing table setting to Internal Local Gateways)
- Firewall

External: Fixed External Port IP or DHCP client (Dynamic IP assigned)

Internal: Device Fixed IP, DHCP Server

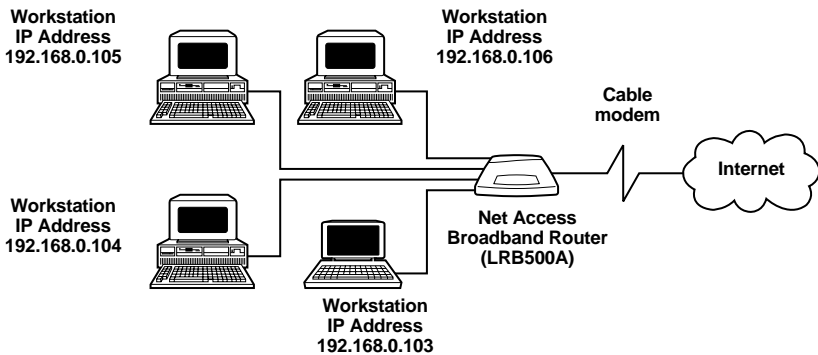

**Figure 2-3. Connect remote site via a cable modem.**

### 2.3.2 CONNECTING A LOCAL SITE BY SEGMENTING THE LAN

In this application, the Router is used to connect LAN segments within a local site.

Kernal: Static Routing (Routing table to External or Internal Gateways)

- Firewall

External: Fixed External IP or DHCP client (Dynamic IP only)

Internal: Device Fixed IP, DHCP Server

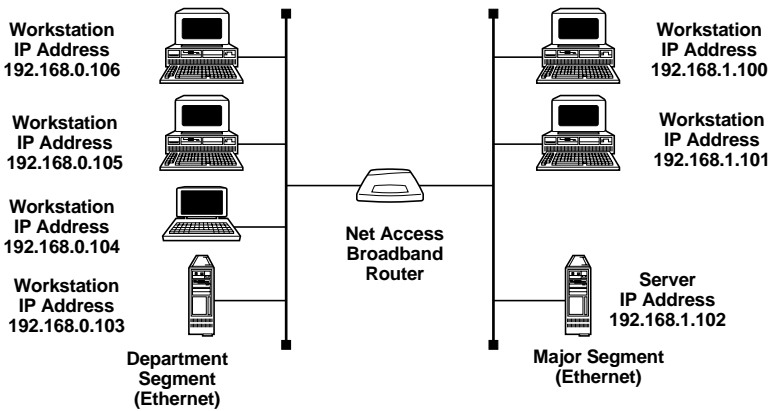

**Figure 2-4. Connect local site (segmenting the LAN).**

### 2.3.3 CONNECTING A LOCAL SITE TO THE INTERNET

In this application, the Router is used to connect up to 253 internal IP addresses to the Internet using a single shared external IP address.

Kernal: NAT (outgoing TCP/IP connection sharing single External Port IP or using multiple IP Mapping)

- Virtual Server (allow incoming specific TCP/IP service request redirect to internal server)
- Firewall

External: Fixed External Port IP and mask DNS IP, Gateway IP, or DHCP client (Dynamic IP for the device, DNS and Gateway assigned.)

Internal: Device Fixed IP, DHCP Server

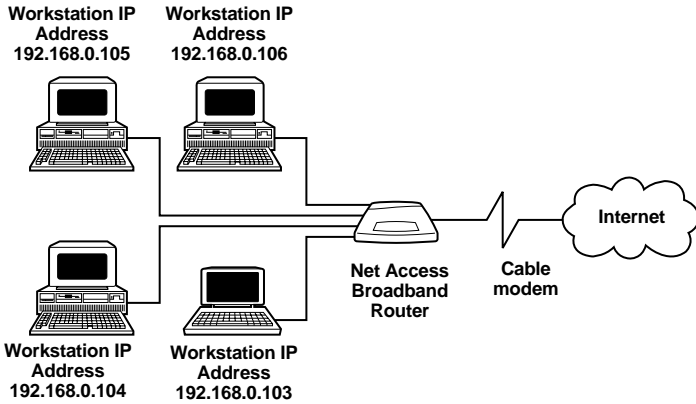

**Figure 2-5. Connect local site (one external IP address = 253 internal IP addresses).**

## 3. Hardware Installation

### 3.1 Safety

1. Never install telephone wiring during a lightning storm.
2. Never install telephone jacks in a wet location unless the jack is specifically designed for wet locations.
3. This product is to be used with UL<sup>®</sup> and cUL listed computers.
4. Never touch uninsulated telephone wires or terminals unless the telephone line has been disconnected at the network interface.
5. Avoid using a telephone (other than a cordless type) during an electrical storm. There may be a remote risk of electrical shock from lightning.
6. Do not use the telephone to report a gas leak in the vicinity of the leak.
7. To reduce the risk of fire, use only No. 26 AWG or larger telecommunications line cord.

### 3.2 What the Package Includes

The Router package contains the following items:

- Net Access Broadband Router w/4-Port Switch
- System CD containing PDF of users' manual
- Tucows CD containing browser/shareware
- Power supply
- A Quick Start Guide
- A serial cable

If any of the items is missing or damaged, please contact Black Box at 724-746-5500.

### 3.3 Cabling

Cabling your Router requires making the appropriate connections to PCs, cable or DSL modem, analog modem or ISDN TA (optional), AC power, and the router. Because this device also acts as a DHCP server, after your device is properly cabled, you will need to follow the configuration instructions provided in **Chapter 4**.

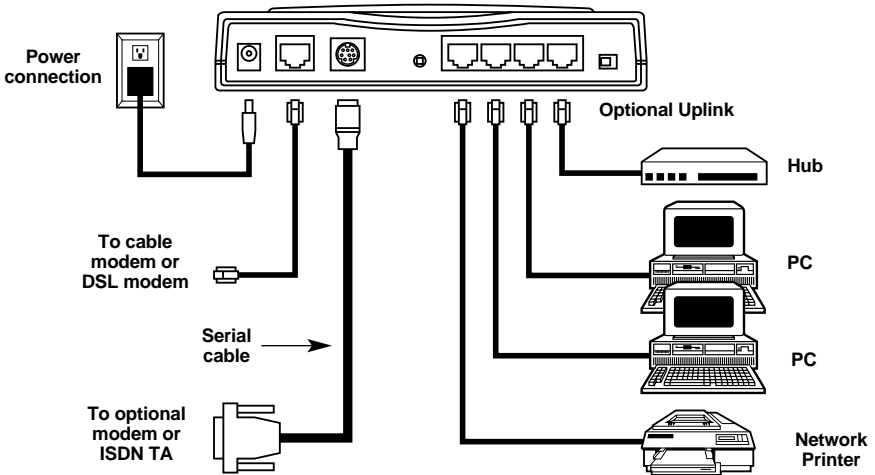

**Figure 3-1. Cabling the Router.**

1. Before beginning, turn the power off on all network devices (PCs, cable, DSL modems, analog modems, ISDN TAs, and the router).
2. Connect the Ethernet port of each PC or network device to one of the 4 LAN ports (if you are using the uplink option, port number 1 cannot be used to connect to a PC).
3. If you are using an analog modem, connect it to the serial async port.
4. If you are using the uplink option to connect to another network segment, slide the uplink/normal switch into the uplink position. Connect the LAN cable to LAN port #1. Plug the other end of the LAN cable into another hub, router, or switch.

#### NOTE

If you are not using the uplink feature, place the switch in the normal position.

5. Connect a network cable from the cable or DSL modem to the 10BASE-T WAN port.
6. Connect the provided power supply cable to the 5-VDC power port on the back of the router. Plug the power supply into an AC power outlet as shown on the previous page.
7. Power on your DSL modem or cable.
8. If you are using an analog modem or ISDN TA, power on the device.
9. Press and hold the Router's Reset button for 3 seconds to restore the default settings.

You are ready to configure software for your Router and network PCs.

## 4. Software Installation and Configuration

Before beginning the installation process, make sure that your system meets all hardware and software requirements:

- Intel® 486 or higher processor.
- 10/100 BASE-T cable to connect the Router to the network.
- One DSL or cable modem.
- A networked computer with Windows® 95/98/2000, Windows NT® 3.5 or higher and TCP/IP protocol installed (or a non Windows system with TCP/IP properly installed to enable Telnet configuration).
- Any Windows communication application for dial-out operation.
- Any PPP-supported communication application for dial-in operation.
- TCP/IP installed and configured on each workstation accessing the Internet.

### 4.1 Software Installation

The software installation process involves installing the Broadband Manager Utilities, including Broadband Manager Setup Wizard, Broadband Manager, and Broadband Monitor. A description of each component follows:

#### **BROADBAND MANAGER SETUP WIZARD**

The Broadband Manager Setup Wizard provides a step-by-step process to assist you in entering all the basic settings needed to configure your Router for general use. All settings that are entered in the Setup Wizard can be found in their respective menus in the Broadband Manager.

#### **BROADBAND MANAGER**

Broadband Manager is the main program used to configure all settings for your Router. Complete information about options within the Broadband Manager can be found in **Chapter 6**.

### BROADBAND MONITOR

Broadband Monitor is a multi-purpose utility designed to let you know the status of your Router connection. The monitor offers the ability to point and click on an event to access troubleshooting procedures. Refer to **Chapter 7** for more information.

## 4.2 Using the Setup Wizard

### NOTE

**Before beginning this procedure, make sure that your Router is properly connected to the network and is powered on.**

After installing the software, you may return to the Broadband Manager Setup Wizard at any time by clicking **Start, Programs, Broadband Manager, Broadband Wizard**.

Before running the Setup Wizard, we strongly recommend that you exit all Windows programs.

1. Insert the Broadband Manager System CD into your computer's CD-ROM drive. The Broadband Manager System CD screen appears.

### NOTE

**If Autorun is disabled on your computer, use Windows Explorer to view the contents of the CD. Double-click the CD icon to display the Router System CD main screen.**

2. Click **Install Software**.
3. Follow the on-screen instructions to install the software.



4. When the software installation completes, the Setup Wizard dialog box appears.

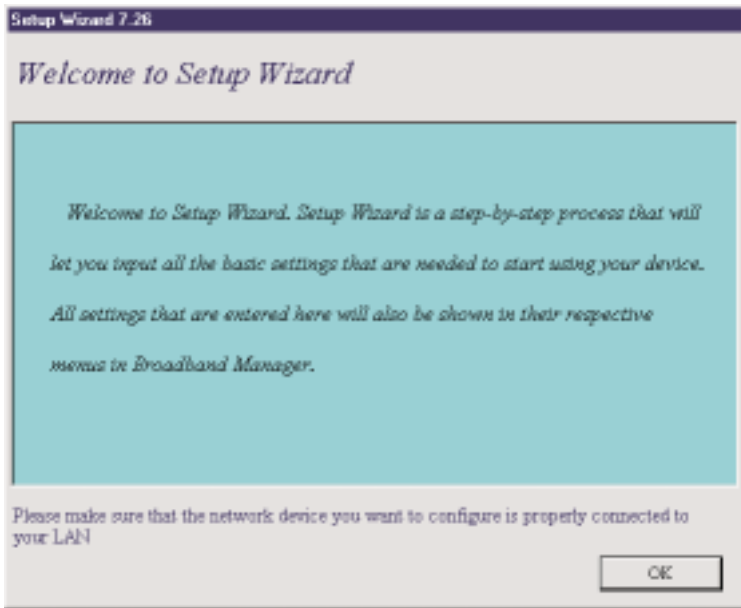

**Figure 4-1. Setup Wizard dialog box.**

Click **OK**.

5. The Setup Wizard: Device List dialog box appears. The Setup Wizard automatically checks your network for available network devices and displays them on the screen.

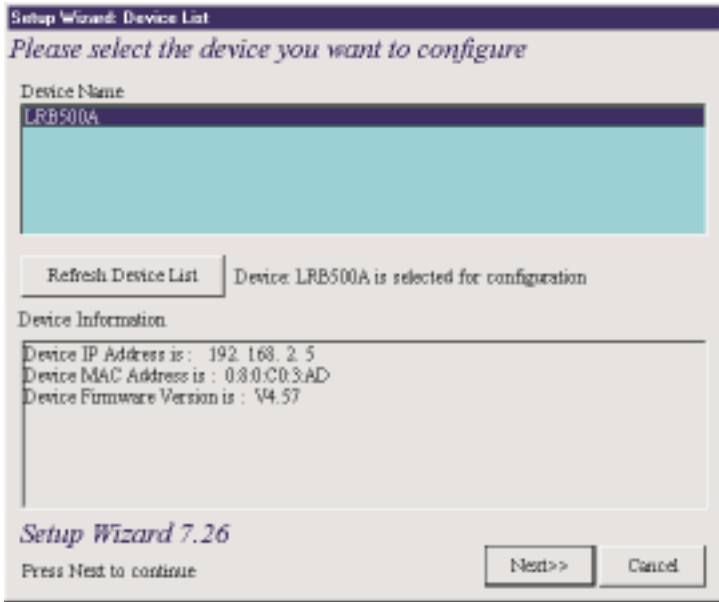

**Figure 4-2. Setup Wizard: Device List dialog box.**

Select the device you wish to configure from the Device Name list.

Record the values presented in the Device Information panel for later reference.

Device IP Address \_\_\_\_\_

Device MAC Address \_\_\_\_\_

Device Firmware Version \_\_\_\_\_

Click **Next>>**.

### NOTE

If a message indicates the device is not found, or you do not see the device you are attempting to configure listed, click the Refresh Device List button.

- The Setup Wizard: Device IP Address dialog box appears.

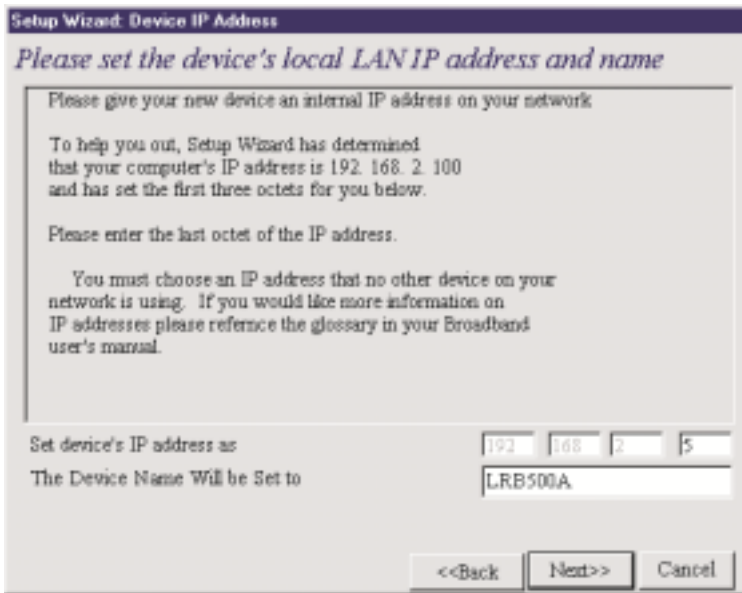

**Figure 4-3. Setup Wizard: Device IP Address dialog box.**

- Enter your local internal network's IP address for this device.

The Setup Wizard will automatically detect the first three octets of your local IP address. You must enter the last octet only.

- If you wish, you can change the network name of your Router. If your ISP requires your device to have a name, you may use the value entered in this field.
- Click **Next>>** to continue. The device will search the network to ensure that the IP address is valid. This may take several seconds.

### NOTE

If your ISP provided you with an IP address, do not enter that address in this field. Enter the IP address for this device on your local network. Refer to Appendix B for additional information on IP addressing.

7. The Select Function dialog box appears.

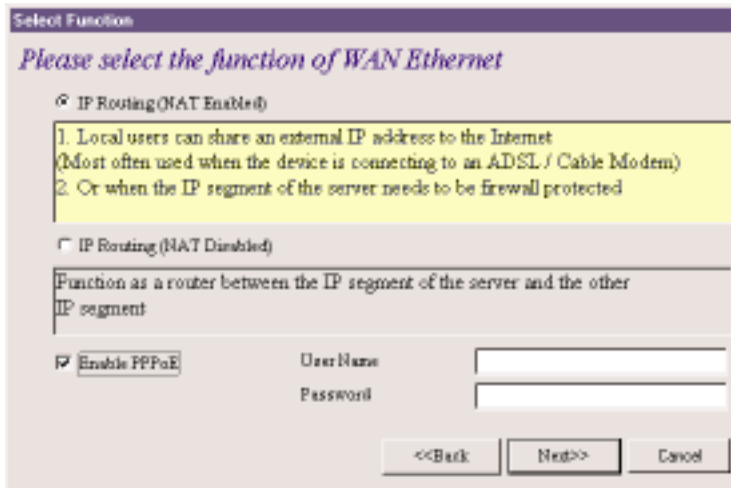

**Figure 4-4. Select Function dialog box.**

Select the function of the WAN Ethernet port by choosing IP Routing (NAT Enabled) or IP Routing (NAT Disabled). If you are using NAT Enabled, you may also select Enable PPPoE .

- Select IP Routing (NAT Enabled) to allow local LAN clients to share one external IP address for accessing the Internet. This option is most often used when the Router is connected to a DSL or cable modem, or when the IP segment of the server needs firewall protection.
- Select IP Routing (NAT Disabled) to allow the Router to function as a router between IP segments. This option is ideal for organizations that need to segment workgroups.
- Select Enable PPPoE to use the Router with a time-base, rather than fixed-cost DSL modem connection. Enter the User Name and Password provided by your ISP. This option is most often used when connecting via DSL to the Internet.

## NOTE

Enable PPPoE is valid only when IP Routing (NAT Enabled) is selected.

Click **Next>>**.

8. The External IP Assignment dialog box appears.

External IP Assignment

Please input external (WAN Ethernet) IP Information

External IP Address: 0 0 0 0

External IP Netmask: 255 255 255 0

External Gateway IP Address: 0 0 0 0

\*Note: WAN Ethernet IP Address: 0 0 0 0 indicates IP address assigned by remote server

<<Back Next>> Cancel

**Figure 4-5. External IP Assignment dialog box.**

Enter the WAN Ethernet IP address information provided by your ISP or other external network administrator.

- In the External IP Address box, enter the WAN Ethernet IP Address.
- In the External IP Netmask box, enter the Netmask of the WAN Ethernet IP Segment (for Class C networks, the Netmask is generally set to 255.255.255.0).
- In the External Gateway IP Address box, enter the IP address of the Gateway to the destination network.

## NOTE

If your ISP uses dynamic IP addressing (DHCP), leave the External IP address and the External Gateway IP address at the default values of 0.0.0.0. Set the External IP Netmask to the default value of 255.255.255.0.

Click **Next>>**.

9. The Asynchronous port function dialog box appears. Select 1) **Remote Access**, 2) **IP Routing (NAT Enabled)**, or 3) **IP Routing (NAT Disabled)**.

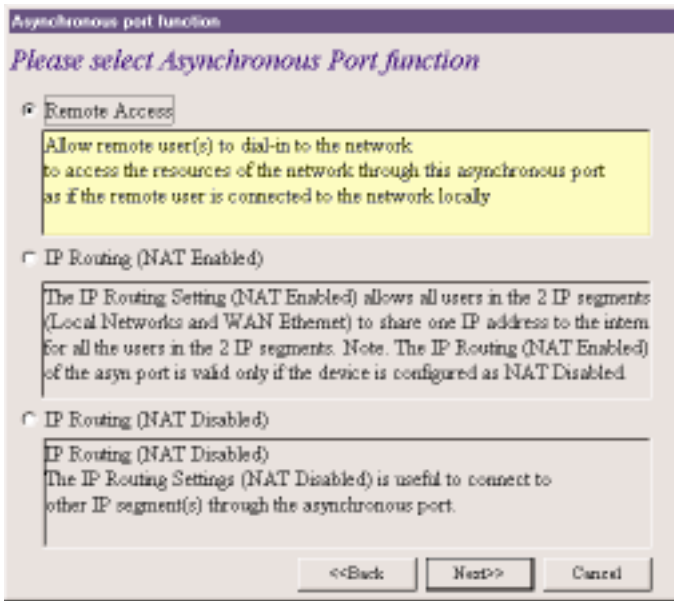

**Figure 4-6. Asynchronous port function.**

- Select **Remote Access** to allow remote users to dial-in to the network to access resources as if the remote user is connected to the network locally.
- Select **IP Routing (NAT Enabled)** to allow all users in the two IP segments (LAN and WAN Ethernet) to share one IP address to the Internet. You may also select this option to use the serial async port for dial backup in the event the DSL or cable modem becomes unavailable.
- Select **IP Routing (NAT Disabled)** to connect other IP segments through the serial async port.

### NOTE

The **IP Routing (NAT Enabled)** feature of the serial async port is valid only if the WAN port is configured as **NAT Disabled**.

Click **Next>>**.

**1.) REMOTE ACCESS**

You must define the location of your remote user account database by selecting  
a) **Use Local Client List** or b) **Use RADIUS Server**.

**NOTE**

**The Local Client List allows you to add a maximum of 64 users.**

**A.) USE LOCAL CLIENT LIST**

Use Local Client List allows you to create an authentication database consisting of user names, passwords, and dial-in options for each remote user. You must provide the following information for each client:

Setup Wizard: Remote Access  
*Please Input Your Remote Access Settings*

Use Local Client List       Use RADIUS Server

Client List

guest	User Name	Jane Doe
	Password	*****
	Password Verification	*****
	Callback Type	Fixed Callback
	Callback TelNumber	9,555-1212

Add      Delete

Other Default Remote Access Settings are  
Remote Access authentication method is "PAP"  
Remote User IP address is automatically assigned  
TCP/IP and IPX/SPX are enabled  
IPX/SPX Frame Type : Autodetect

<<Back      Next>>      Cancel

**Figure 4-7. Use Local Client List screen.**

User Name:

Enter the User Name to authenticate the remote dial-in user.

Password:

Enter the Password to authenticate the remote dial-in user. Passwords are limited to 16 characters.

Password Verification:

Re-enter the remote dial-in user's password.

Callback Type:

Select one of the following three callback options for each remote client:

- **No Callback:** Select this option to allow the remote user to immediately connect to the network after being authenticated. No Callback is the default setting.
- **Fixed Callback:** This option allows you to specify a fixed callback telephone number for the user. After the PPP negotiation, the device will disconnect, then callback the telephone number you enter in the callback telephone number field. This option is best used for clients requiring callback security while dialing-in from the same location each time.
- **Variable Callback:** Select this option for remote users that travel or dial-in from various locations and need callback security. This option allows clients to specify the callback telephone number each time they connect to the network.

Click **Add** after entering information for each Local Client.

Click **Next>>** and continue with Step 10 when all users have been added to the database.



**B.) USE RADIUS SERVER**

Select this option if you would like your remote clients to be authenticated on a RADIUS server. You must enter the following RADIUS Server Settings:

The screenshot shows a 'Setup Wizard: Remote Access' window with the title 'Please Input Your Remote Access Settings'. Below the title, it says 'The settings apply to :'. There are two radio buttons: 'Use Local Client List' (unselected) and 'Use RADIUS Server' (selected). Under the 'RADIUS Server Settings' section, there are four input fields: 'RADIUS Access Server IP Address' (192.168.2.22), 'RADIUS Access Accounting Server IP Address' (checked, 192.168.2.22), 'Secret' (masked with asterisks), and 'Secret Verification' (masked with asterisks). At the bottom, there is a yellow box with text: 'Other Default Remote Access Settings are: Remote Access authentication method is "PAP", Remote User IP address is automatically assigned, TCP/IP and IPX/SPX are enabled, IPX/SPX Frame Type: Autodetect'. Navigation buttons at the bottom are '<<Back', 'Next>>', and 'Cancel'.

**Figure 4-8. Use RADIUS Server screen.**

**RADIUS Access Server IP Address:** Enter the IP address of the RADIUS Access Server.

**RADIUS Access Accounting Server IP Address:** Enter the IP address of the RADIUS Accounting Server.

**Secret:** Enter your Secret RADIUS code or password.

**Secret Verification:** To confirm your Secret code, re-enter your code or password.

### NOTE

In most cases, the RADIUS Access Server and the RADIUS Accounting Server are the same server, so the IP addresses will also be the same.

Click **Next>>** and continue with Step 10.

## 2.) IP ROUTING (NAT ENABLED) AND

## 3.) IP ROUTING (NAT DISABLED)

If you select **IP Routing** for the asynchronous port, the Setup Wizard: IP Routing dialog box appears.

	Telephone	User Name	Password	Password Verification
Async Port	555-1212	Jane Doe	*****	*****

**Figure 4-9. Setup Wizard: IP Routing dialog box.**

Enter the information required to dial-up and log into your ISP's remote server:

**Telephone Number:** Enter the phone number used to dial your remote server (ISP).

### NOTE

If you must dial a number to get an outside line (for example, "9", or "0"), enter the required number plus a "w"(wait) or a comma in the Telephone box (for example, 9w555-2323 or 9,,5552323). Each comma provides a 3–4 second delay.

**User Name:** Enter the User Name for your remote server or ISP account.

**Password:** Enter the Password for your remote server or ISP account.

**Password Verification:** Re-enter the password for your remote account.

Click **Next>>**.

10. The Setup Wizard: DNS IP Address dialog box appears.

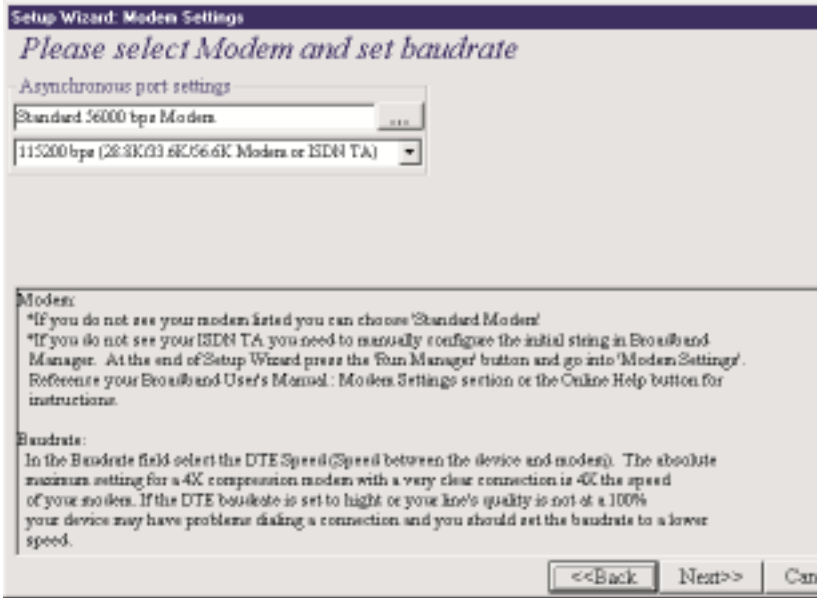

**Figure 4-10. Setup Wizard: DNS IP Address dialog box.**

Enter your ISP's DNS Server IP address. If you are not sure of the IP address, contact your ISP.

Click **Next>>**.

11. The Setup Wizard: Modem Settings dialog box appears.



**Figure 4-11. Setup Wizard: Modem Settings dialog box.**

The final step in configuring your Router for basic operations is to define your modem Manufacturer, Model, and the DTE baud rate or speed of communication between the Router's serial async port and your modem or ISDN TA.

Select your modem and baud rate as described on the following pages.

### NOTE

**If you do not have a device attached to the serial async port, use the default modem values and click Next>>.**

12. To select your modem, in the Asynchronous port settings box

click  .

The system loads modem information.

13. The Modem Initial Command dialog box appears.

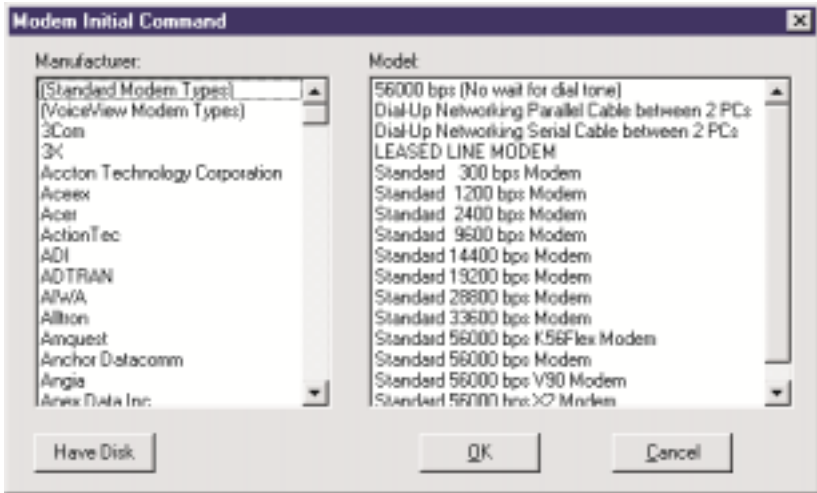

**Figure 4-12. Modem Initial Command dialog box.**

Select your modem manufacturer, then select the model from the list provided. Click **OK** (if your modem is not listed and you have a driver disk, click **Have Disk...** to install your modem).

### NOTE

This setting configures the initial string of the asynchronous port on the Router so that it will know how to communicate with your modem. If you are using an analog modem and your modem is not included in the selection list, Standard Modem will work (in most cases). If you are using an ISDN TA, refer to the ISDN TA's User Guide for information on the initialization and hang-up strings. Use Broadband Manager to enter modem strings.

14. The Setup Wizard: Modem Setting dialog box re-displays.

Use the Asynchronous port settings list to select the baud rate. Select the DTE speed (that is, the speed of communication between the asynchronous port of the Router and the modem). For DCE speed compression modems, this value can normally be set to about 4 times the speed of your modem. Keep in mind that if you set the baud rate too high, the dial-up connection may fail.

## NOTE

You may need to set a lower baud rate since the theoretical maximum connection speed may not be attainable due to variations in quality of phone line and ISP connections.

Click **Next>>** to complete the basic configuration.

- The Check List dialog box appears. It summarizes your configuration selections. Make sure that all values have been correctly entered. If you find an incorrect setting, click <<**Back** to return to the screen containing the error and correct it. When complete, use the **Next>>** button to return to the Check List dialog box.

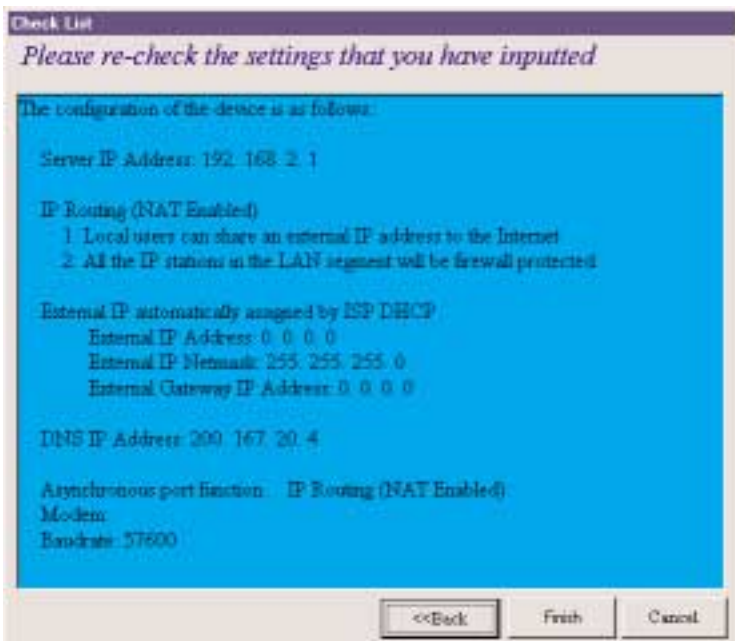
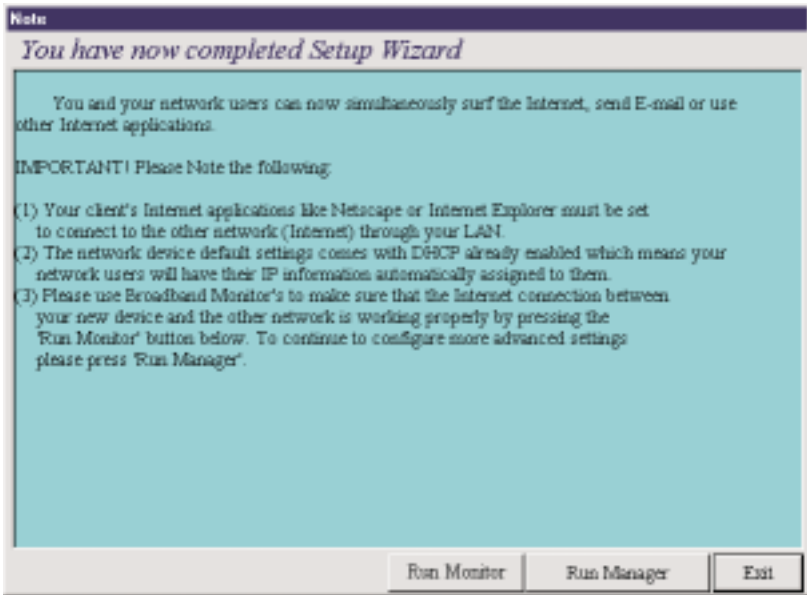

Figure 4-13. Check List dialog box.

Click **Finish** to complete the configuration.

16. The Note dialog box appears. It indicates that you have completed the Setup Wizard.



**Figure 4-14. Note dialog box.**

Read the “IMPORTANT!” information contained in the dialog box. Choose **Run Monitor** (recommended), **Run Manager**, or **Exit**.

### 4.3 Testing Your Connection

When you select Run Monitor, the Broadband Monitor program loads.

1. To test your current settings, select **Test Connection**. Select **Connect Port 1** to test the WAN port. Select **Connect Port 2** to test the serial async port. The monitor activity will appear in the display window. Refer **Chapter 7** for additional information about the monitoring capabilities of the Router.
2. After successfully using the Test Connection option in Run Monitor, refer to **Chapter 8** to continue with your installation by configuring your LAN workstations.

### NOTE

If a problem occurs while testing your connection, or you need to configure more advanced options for your Router, use Broadband Manager by selecting Programs, Broadband Manager, Broadband Manager.



## 5. Telnet

Telnet is a telecommunications software utility that allows you to access a remote device. The Router has a built-in Telnet Server that enables a Telnet client to remotely configure the device using a menu system.

### IMPORTANT

Non Windows operating system users must use the Telnet menu system to define the function of the WAN and async ports, to define how IP addresses are administered, to configure IP addresses on your local and remote systems, and to set up any necessary virtual server, routing table, and packet filtering options.

### NOTE

To successfully configure your router using Telnet, TCP/IP must be correctly configured on your computer. The router and computer must also be located on the same subnet.

### 5.1 Starting a Telnet Session

1. Start your telnet session and connect to the Router using the router's default IP address of 192.168.2.1 and vt100 terminal emulation.

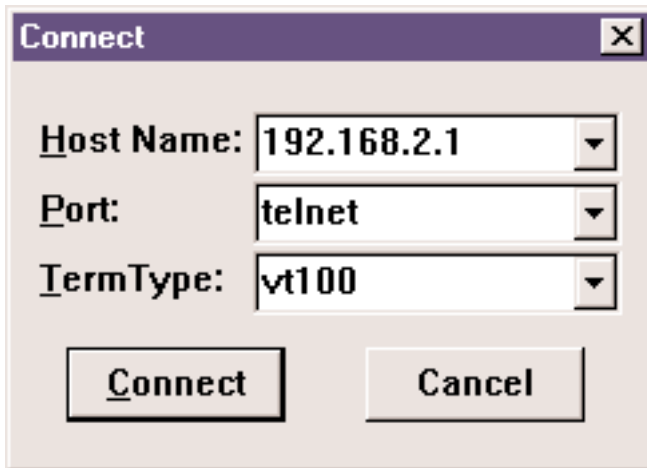

Figure 5-1. Connect screen.

If you are using a graphical interface such as the one shown above, click **Connect**.

2. When prompted to input the Router Password, press **Enter**.
3. The Router Telnet Server Menu appears.

```
Please input ROUTER password  
Password:
```

```
ROUTER SETTINGS  
a). ROUTER IP ADDRESS  
b). ROUTER SUBNET MASK  
c). ROUTER NAME  
d). ROUTER PASSWORD  
e). WAN ETHERNET MAC ADDR.  
f). WAN ETHERNET SETTINGS  
g). ASYNC PORT SETTINGS  
h). ROUTER DNS IP ADDRESS  
i). DHCP SERVER  
j). VIRTUAL SERVER  
k). ROUTING TABLE  
l). CLIENT FILTER SETTINGS  
m). LOAD DEFAULT SETTINGS  
n). SAVE AND RESTART SERVER  
o). DIAGNOSTIC  
q). QUIT  
Select ?
```

**Figure 5-2. Telnet Server menu.**

## 5.2 Using the Telnet Server Menu

To use the menu, type the letter corresponding to the parameter you'd like to change.

Depending on the parameter you are changing, you are presented with an open field into which you may type new information, or you are presented with a list of options from which you may select a value. Each menu item is described in the following pages.

## NOTE

After entering parameters for all settings that you want to change, continue to type "q" to return to the previous menu until you reach the main Telnet Server menu. Select **Save** and **Restart Server** to save your new configuration.

### a). **ROUTER IP ADDRESS**

Enter the IP address assigned to the Router on your local network. The new address will take effect after you have selected **Save** and **Restart Server**.

### b). **ROUTER SUBNET MASK**

Enter the subnet mask for your local network.

### c). **ROUTER NAME**

Enter a network name for the Router. If your ISP requires your device to have a name, you may use the value entered in this field.

### d). **ROUTER PASSWORD**

The default is no password. If you choose to use a password, ensure that you write the password down and keep it in a safe place. If you forget the password, contact Black Box Technical Support at 724-746-5500 for assistance.

### e). **WAN ETHERNET MAC ADDR.**

This field displays the current MAC address of your router. Edit this field only if required by your remote system or ISP.

**f). WAN ETHERNET SETTINGS**

Define the function of the WAN port by selecting **Internet Access (IP Routing - NAT Enabled)** or **LAN-to-LAN access (IP Routing - NAT Disabled)**. Refer to **Section 6.1.2** for more information.

```

f). WAN Ether SETTINGS
FUNCTION SETTING
a). INTERNET ACCESS
b). LAN-to-LAN ACCESS
Select ? █

```

**Figure 5-3. Selecting Internet access.**

*a). Internet Access*

If you use the WAN port for Internet Access, you must configure the following options:

```

INTERNET ACCESS PORT SETTING
a). WAN ETHERNET PORT IP ADDRESS      <0.0.0.0>
b). WAN ETHERNET PORT IP NETMASK      <255.255.255.0>
c). WAN ETHERNET GATEWAY IP ADDRESS   <0.0.0.0>
d). PPPoE                              <ENABLE>
e). PPPoE USER NAME                   <>
f). PPPoE PASSWORD                     <>
g). PREVIOUS MENU                      <>
Select ?

```

**Figure 5-4. WAN Port options.**

Enter the IP port information provided by your ISP or other external network administrator.

**NOTE**

If your ISP uses dynamic IP addressing, leave the External Port IP address and External Gateway IP address at the default values of 0.0.0.0. Set the External IP Netmask to the default value of 255.255.255.0.

*b). LAN-to-LAN Access*

To use the WAN port to connect to another LAN, you must configure the following:

```
LAN to LAN PORT SETTING
a). WAN ETHERNET PORT IP ADDRESS      <0.0.0.0>
b). WAN ETHERNET PORT IP NETMASK     <255.255.255.0>
q). PREVIOUS MENU
Select ?
```

**Figure 5-5. LAN-to-LAN access.**

Enter the IP and Netmask address of the network to which you are connecting.

*g). ASYNC PORT SETTINGS*

The async port may be used for IP Routing or Remote access. For more information, see **Chapter 6**.

***IP Routing***

If you will use the async port for IP Routing, enter the following information as described:

```

IP ROUTING PORT SETTING
a). TELEPHONE NUMBER          <>
b). USER NAME                 <>
c). PASSWORD                  <>
d). IDLE TIMEOUT              <5>
e). SERIAL BAUDRATE           <115200>
f). MODEM PRE-INITIAL STRING  <AT>
g). MODEM INITIAL STRING     <AT S0=1>
h). MODEM DIALUP STRING      <ATDT>
i). MODEM HANGUP STRING      <ATH0>
j). LOGIN SCRIPT              <DISABLE>
k). EDIT LOGIN SCRIPT
l). EXTERNAL IP ADDRESS       <0.0.0.0>
m). NAT FUNCTION              <ENABLE>
n). ASSIGN REMOTE IP         <DISABLE>
q). PREVIOUS MENU
Select ?

```

**Figure 5-6. IP Routing.**

***a). Telephone Number***

Enter the phone number the async device must dial to connect to the remote system.

***b). User Name***

Enter the User Name that will be used for authentication on the remote system.

***c). Password***

Enter the Password associated with the User Name for the remote system.

***d). Idle Timeout***

Enter the amount of idle time allowed to pass before the connection times out. The default value is 5 minutes.

***e). Serial Baud rate***

Use the list to select the appropriate baud rate of the modem attached to your

async port. You may need to select a lower speed to ensure a quality connection.

*f). Modem Pre-Initial String*

Consult your modem or ISDN TA User Guide for this information. The default value will work for most analog modems.

*g). Modem Initial String*

Consult your modem or ISDN TA User Guide for this information.

*h). Modem Dialup String*

Consult your modem or ISDN TA User Guide for this information.

*i). Modem Hangup String*

Consult your modem or ISDN TA User Guide for this information.

*j). Login Script*

Select **Enable** or **Disable**.

*k). Edit Login Script*

Refer to **Chapter 6** for information on editing scripts.

*l). External IP Address*

Enter the IP address of the remote device to which you are connecting.

*m). NAT Function*

Select **Enable** or **Disable**. Refer to **Appendix C** for additional information on NAT.

*n). Assign Remote IP*

Select **Enable** or **Disable**. If you select **Enable**, you will be prompted to enter an

address to be assigned to the remote system.

### *Remote Access*

Remote Access: To configure the async port for Remote Access, enter values for each of the following fields:

```

REMOTE ACCESS PORT SETTING
a). IP ASSIGNED METHOD           <AUTOMATICALLY>
b). PROTOCOLS                   <BOTH IP & IPX ENABLED>
c). IPX/SPX FRAME TYPE         <AUTODETECT>
d). AUTHENTICATION METHOD       <PAP>
e). EDIT USER DATABASE
f). IDLE TIMEOUT                <0>
g). SERIAL BAUDRATE            <115200>
h). MODEM PRE-INITIAL STRING   <AT>
i). MODEM INITIAL STRING      <AT S0-1>
j). MODEM DIALUP STRING        <ATDT>
k). MODEM HANGUP STRING        <ATH0>
l). EDIT LOGIN SCRIPT
q). PREVIOUS MENU
Select ? █

```

Figure 5-7. Remote Access Port settings.

#### *a). IP Assigned Method*

Select the method the client will use to have their IP address assigned.

#### *b). Protocols*

Default value is Both IP and IPX enabled. You may select to use only one protocol; however, if you are connecting to a NetWare server, you must have IPX™ enabled.

#### *c). IPX/SPX Frame Type*

The default value is Autodetect. If you have problems with your network connection, you may select Ethernet\_II, Ethernet\_802.3, Ethernet 802.2, or Ethernet\_snap.

#### *d). Authentication Method*

Select either **None**, **PAP**, or **CHAP**. Refer to **Chapter 6** for additional information.

#### *e). Edit User Database*

To add users to the database, select the next available letter. Enter the User Name, Password, and Callback type for each user that you add to the database. You may



enter up to 64 remote clients.

*f). Idle Timeout*

The default value is 5 minutes.

*g). Serial Baud rate*

Select one of the available options. You may need to use a slower speed to ensure a quality connection.

*h). Modem Pre-Initial String*

Refer to your modem or ISDN TA User Guide for information. The default value will work for most analog modems.

*i). Modem Initial String*

Refer to your modem or ISDN TA User Guide for information.

*j). Modem Dialup String*

Refer to your modem or ISDN TA User Guide for information.

*k). Modem Hangup String*

Refer to your modem or ISDN TA User Guide for information.

*l). Edit Login Script*

Select this option to edit the login script executed when the client connects to the network. Refer to **Chapter 6** for additional information about creating and editing scripts.

**RADIUS Server:** Select **Enable** to configure remote users to authenticate on a RADIUS Server.

**RADIUS Access Server IP:** Enter the IP address of the RADIUS Access server.

**RADIUS Accounting Server IP:** Enter the IP address of the RADIUS Accounting server. In most configurations, the Access and Accounting server are located on the same machine, so the IP address is the same for both fields.

**RADIUS Secret:** Enter the secret code or password for the RADIUS Server.

**h). ROUTER DNS IP ADDRESS**

Enter the IP address of your Internet Service Provider's DNS server.

**i). DHCP SERVER**

You may select **Disable** or **Enable**. If you would like the Router DHCP server function to provide IP information to workstations as they connect to the network, select **Enable**. When you enable DHCP, you will be prompted to provide the beginning and ending IP addresses in the range of addresses administered by your Router. Refer to **Section 6.3** for additional information.

**j). VIRTUAL SERVER**

Select **Disable** or **Enable**. If you select **Enable**, you may enter the external and internal IP Addresses necessary to allow remote clients to access specific devices on your network via the Internet. Refer to **Chapter 6** for more information about enabling IP Mapping.

**k). ROUTING TABLE**

The Routing Table option lets you create a routing table so your Router will route IP packets to the proper network. For more information, refer to **Section 6.4**.

**l). CLIENT FILTER SETTINGS**

The Filter Settings option allows you to define which packets are allowed to either pass through, or be blocked from passing through the Router ports. You may filter packets for network services including Mail, WWW, FTP, Telnet, and News. See **Section 6.5** for more information about filtering options.

**m). LOAD DEFAULT SETTINGS**

Use this option to return the router to the factory-default settings.

**n). SAVE AND RESTART SERVER**

This option saves your Router configuration into Flash memory and restarts the device to enable the settings to take effect. The system will pause while settings are being saved.

**NOTE**

After completing your configuration, you must select **Save and Restart Server** or your settings will be lost when the device is powered off.

**o). DIAGNOSTIC**

The Diagnostic option performs basic testing of the Router, displays information about your firmware, and offers options for assigning the LAN and WAN MAC addresses as may be required by your ISP.

```

o). DIAGNOSTIC
. Firmware Code Version U3.92
. DRAM TESTING.....OK
. Firmware Code Checksum.....PASS
. UM9008 WAN ETHER.....PASS
. UM9008 WAN ETHER MAC..... 00:00:00:00:00:FF
. MAC ADDR for LAN..... 00:00:00:00:01:FF
>>>>
Type 'p' to assign WAN MAC.
    'n' to assign LAN MAC.
    other to Exit.

```

**Figure 5-8. Diagnostic screen.**

Type any key to return to the main menu.

**p). QUIT**

## 6. Broadband Manager

Broadband Manager is the main program used to configure all the settings of your Router.

1. To run Broadband Manager, click on the Broadband Manager icon on your desktop, or click **Start, Programs, Broadband Manager, Broadband Manager**.
2. The Manager dialog box appears.

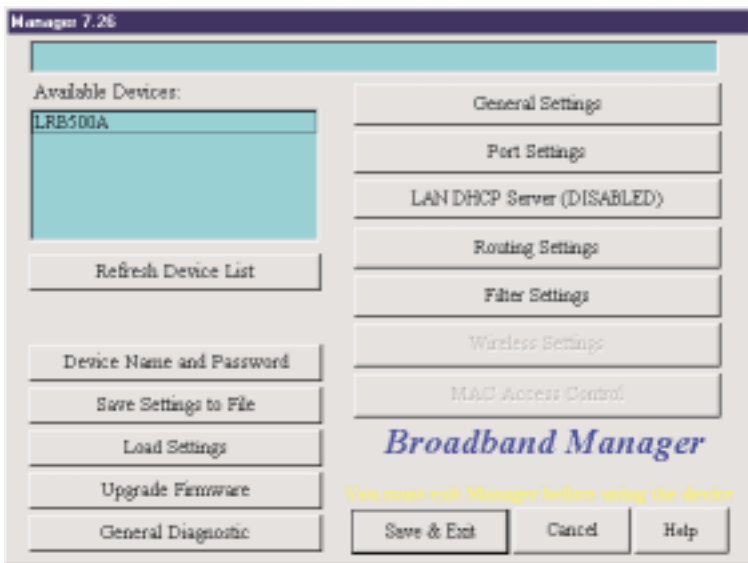

**Figure 6-1. Manager dialog box.**

3. The Router automatically searches your network for devices available for configuration and displays them in the Available Devices list box.

### NOTE

Before using any of the Manager options, you must select the device you are attempting to configure from the Available Devices list. If you need to update the list, click Refresh Device List. You must exit Broadband Manager before using the device.

After you have selected a device from the Available Devices list, the Status field provides information about the name, IP address, MAC address, and Firmware version of your Router.

The buttons in the left column of the screen offer the ability to change the device's name and password, save and load settings, upgrade the firmware, or run general diagnostics on the device. The buttons in the right column provide access to advanced configuration options for General Settings, Port Settings, LAN DHCP Server Options, Router Settings, and Filter Settings. Additional information about all of these options is included in this chapter.

### **NOTE**

**If the IP address of the device you are attempting to configure is not within the same subnet, the "Please Set the Device IP" dialog box displays, requesting you to input an IP address in the same subnet.**

If an error message appears, refer to **Chapter 10**.

## **6.1 General Settings**

After selecting your device from the Available Devices list, select **General Settings** to view or change all of the major network settings for the Router including LAN and WAN Ethernet segment settings, DNS information, IP Routing, and Remote Access settings. Most of the settings on these screens were entered in Setup Wizard; however, some important settings can be entered only in Broadband Manager.

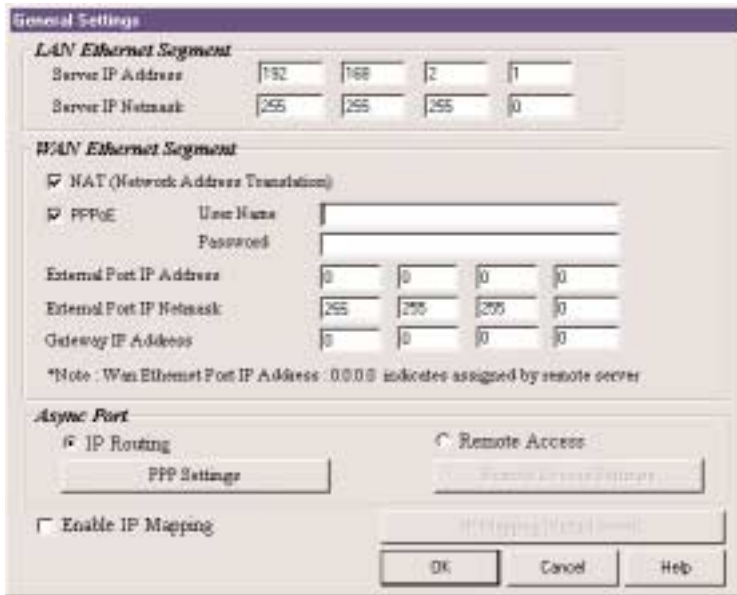

**Figure 6-2. General Settings screen.**

### 6.1.1 LAN ETHERNET SEGMENT

**Server IP Address:** This IP address is the internal LAN IP address of the Router. The address entered into the Setup Wizard is displayed here (for example, 192.168.2.1).

**Server IP Netmask:** The Router subnet mask generally can be left at the default value of 255.255.255.0.

### 6.1.2 WAN ETHERNET SEGMENT

Select **NAT (Network Address Translation)** to provide firewall protection and enable all local LAN users to share one IP address to access the Internet. If the NAT box is not checked, the WAN Ethernet is configured as a router to route network traffic between the LAN Ethernet segment and the WAN Ethernet segment. The External Port IP Addresses are provided by your ISP or remote system administrator.

**PPPoE:** If your ISP uses Point-to-Point Protocol over Ethernet for authentication purposes, select the PPPoE box and enter your ISP account User Name and Password in the fields provided.

External Port IP Address: Enter the IP address provided by your ISP or remote system administrator.

External Port IP Netmask: Enter the subnet mask of the port as provided by your ISP or remote system administrator.

Gateway IP Address: Enter your ISP or remote network's Gateway IP address.

## NOTE

**If your ISP uses a DHCP server to automatically assign a login IP address, subnet mask, gateway IP address or DNS IP address, enter 0.0.0.0 as your External Port IP Address and the Gateway IP Address.**

### 6.1.3 ASYNC PORT

The Async Port can be configured to provide either IP Routing or Remote Access. IP Routing is used to connect your network to another router through the Serial async port. Remote Access allows remote users to dial-in to the device to access and share network resources as if they were logged on to the network locally.

1. To configure the Router for IP Routing, select **IP Routing** in the Async Port section of the General Settings dialog box.
2. Click **PPP Settings**.
3. The IP Routing Settings dialog box appears.

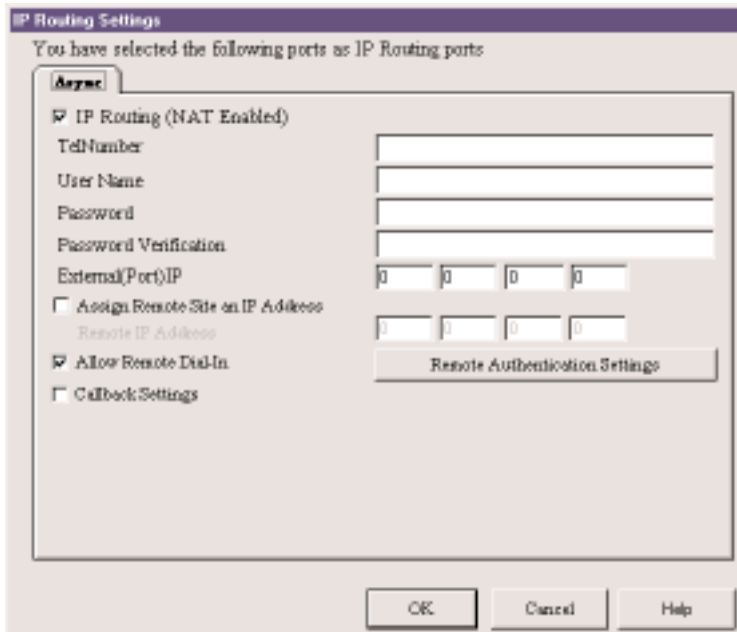

**Figure 6-3. IP Routing Settings dialog box.**

### *IP Routing (NAT Enabled)*

If NAT is enabled, all local users will be firewall protected and will share one IP address through the Async port. Enter values in the fields as described:

**Tel Number:** Enter the phone number required to access your ISP.

**User Name:** Enter the account user name to be authenticated by your ISP.

**Password:** Enter the user account password to be authenticated by your ISP.

**Password Verification:** Re-enter the user account password for verification.

**External (Port) IP:** Enter the fixed IP address provided by the remote site System Administrator. If this address is automatically assigned by the remote site DHCP server, enter 0.0.0.0

**Assign Remote Site an IP Address:** Check the box if you will specify the IP Address of the remote site.

**Remote IP Address:** Enter the IP address the remote site will use.



*Allow Remote Dial-In*

This option allows a remote site to dial-in to this network.

1. From the IP Routing Settings dialog box, select **Allow Remote Dial-In**.
2. Click **Remote Authentication Settings**.
3. The Remote Connection Authentication dialog box appears.

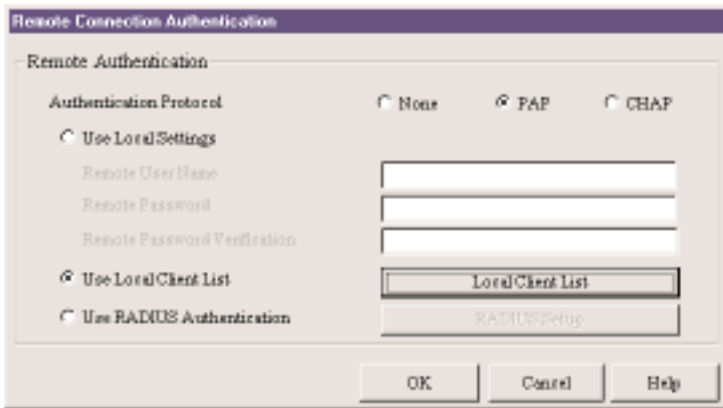

**Figure 6-4. Remote Connection Authentication dialog box.**

4. You must select one of three methods to define the authentication protocol to be used when a remote site is dialing in to your site. You may select:
  - **None**—No authentication needed.
  - **PAP**—User Name and unencrypted Password are transmitted over the network.
  - **CHAP**—DHCP sends a key which is used to encrypt the user name and password. Encryption provides added protection from potential interception of authentication information.

### NOTE

If you select **PAP** or **CHAP**, you must indicate where the authentication process should occur by selecting **Use Local Settings**, **Use Local Client List**, or **Use RADIUS Authentication**. Refer to **Remote Connection Authentication Settings** following this section.

5. Click **OK** when complete.

*Callback Settings*

From a remote site, you can trigger your Router to establish a connection with your ISP.

1. Click **Callback Settings** and select one of three callback options:

a. **No Callback**

b. **Trigger (ISP) Server Connection**—The Router will establish a connection with the ISP server after a remote user dials into the asynchronous port. The device can be triggered to automatically establish a connection with the ISP in one of two ways:

- The ISP server is dialed after the Router receives a PPP (modem) connection from a remote user.
- The Router makes the connection to the ISP server after receiving a regular telephone call. The remote user calls the Router async port to trigger the connection to the ISP server.

c. **Remote Callback**—After dialing, the Router hangs up and waits for the remote site to call back. You must enter the callback telephone number (the telephone number the device should call) in the Tel Number field.

2. Click **OK** to complete.

*Remote Connection Authentication Settings*

When you select **Allow Remote Dial-in**, you must determine the method that remote users must use to be authenticated on your system. If you choose the PAP or CHAP authentication protocol, you must select **Use Local Settings**, **Use Local Client List**, or **Use RADIUS Server** authentication.

**Use Local Setting:** You may create a Remote User Name and Remote Password to log into the system. All users must type the same user name and password that you specify.

**Use Local Client List:** The Local Client list is a list of all User Names and Passwords that can access your network from a remote site. When a remote user dials in to the Router, the user's access profile information (user name, password, callback status, etc.) is validated by checking the user information in this list. The Router can include up to 64 users in the Local Client list. Click **Local Client List** to add your remote users.

## IMPORTANT

The Router is set up with a default guest user, which requires no password. For security reasons, either delete the guest user id or provide it with a password.

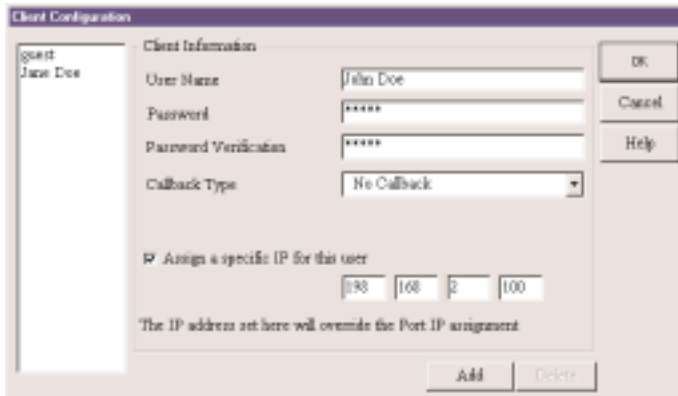

**Figure 6-5. Client Configuration screen.**

**Client Information:** For each new remote user added to the system, enter the following information:

**User Name:** Specify a user name with a maximum of 16 characters.

**Password:** Specify the password corresponding to the user name. Passwords are limited to 16 characters.

**Password Verification:** Verify the password by re-entering the user password in the box provided.

**Callback Type:** The callback feature provides an added level of security to your dial-in system. A remote client dials in to the network and then disconnects. The Router then calls the client back. The feature can be implemented using no callback, fixed callback, or variable callback.

**No Callback:** The Router does not perform a callback function. This is the default setting.

**Fixed Callback:** The Router will connect to the client by dialing the number specified in the Your Tel Number field.

**Variable Callback:** This option allows the remote client to specify the phone number the Router should call each time a dial-up connection is established.

**Assign a specific IP for this user:** Select this option if you would like to have a specific IP address assigned to this user. Enter the IP address in the field provided. This IP address will be used each time the client logs in and will override the Assign Remote Site an IP Address option as shown in the IP Router Setting dialog box, Async tab.

Click **Add** to complete adding this client to the Local Client List.

### *Use Radius Authentication*

Choosing RADIUS Authentication allows you to use the user information (user name, password, IP address, etc.) stored on a separate RADIUS server on the network.

## NOTE

**A RADIUS Server (Remote Authentication Dial-In Service) is an accounting and authentication system used by many large companies and Internet Service Providers (ISPs). After a client dials in to the network and enters their username and password, the information is passed to a RADIUS server. The RADIUS server checks that the information is correct, and then allows access to the system.**

1. From the Remote Access Settings dialog box, in the Remote Users Authentication section, click **Use RADIUS Authentication**, then click **RADIUS Setup**.
2. The RADIUS Configuration dialog box appears.

**Figure 6-6. RADIUS Configuration dialog box.**

3. Use the List box to select the Main or Backup RADIUS Server from which the device will be authenticated.
4. Complete the provided fields for the Access and Accounting Server fields:

**RADIUS Access Server IP Address:**

Enter the IP Address of the RADIUS Access Server.

**RADIUS Accounting Server IP Address:**

Enter the RADIUS Accounting Server IP Address

**NOTE**

In most cases, the RADIUS Accounting Server and the Access server are the same device. If this is true for your configuration, enter the same IP address in both fields.

**Secret:**

Enter your Secret RADIUS code or password.

**Secret Confirmed:**

Re-enter your Secret RADIUS code.

5. Click **OK** when complete.

*Remote Access Settings*

1. From the General Settings dialog box, Async Port section, select **Remote Access** and click **Remote Access Settings**.
2. The Remote Access Settings dialog box appears.

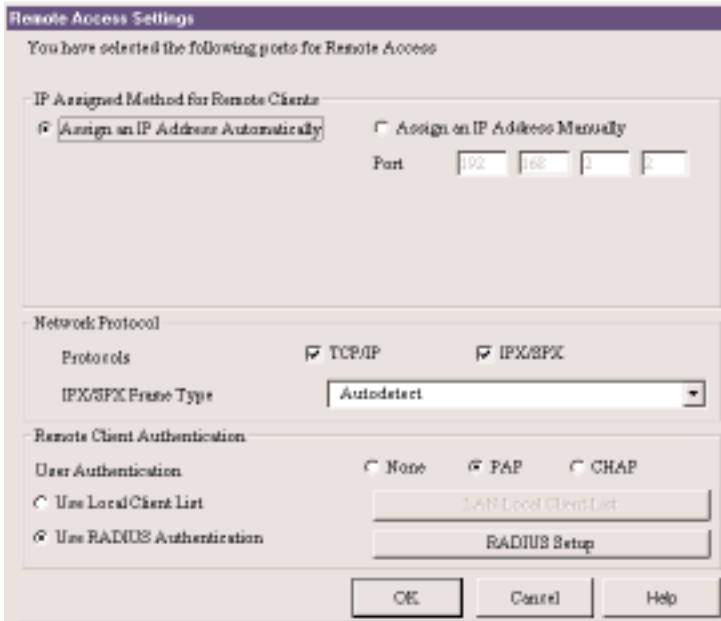

**Figure 6-7. Remote Access Settings dialog box.**

Complete the fields as follows:

#### **IP Assigned Method for Remote Clients:**

A remote client must have an IP address to connect to the network. IP addresses may be assigned automatically from a designated IP address pool using DHCP, or the IP address may be manually assigned.

**Assign an IP Address Automatically:** The Router DHCP feature will issue the remote site user an IP address automatically if the DHCP function is enabled. If DHCP is disabled, the device will automatically search for a DHCP server and request an IP address for the remote client.

**Assign an IP address manually:** Enter an IP address for the remote client.

#### **Network Protocols:**

You must select the network protocols you would like to enable for the dial-in service. The default enables both TCP/IP and IPX/SPX. If you do not need both protocols, you may disable one of them. If you are connecting to a NetWare Server, IPX/SPX must be enabled.

**IPX/SPX Frame Type:** The Router can automatically detect what kind of IPX/SPX frame type you are using. You may manually select a frame type by using the list box.

**Remote Client Authentication:**

Remote authentication settings allow you to specify how you would like to authenticate remote users. You may select **Use Local Client List** or **Use RADIUS Authentication** (refer to Remote Connection Authentication Settings in this chapter for more information). Choosing RADIUS configuration allows you to use the user information (user name, password, IP address, etc.) stored on a separate RADIUS server on the network.

3. Click **OK** when complete.

**Enable IP Mapping:**

IP Mapping is available only when NAT is enabled. If NAT is enabled for a particular port, that port is firewall protected. The Enable IP Mapping function allows you to open a "hole" in your firewall to allow access to your LAN via the Internet. For example, you can use the IP <mapping function to access an FTP server on your LAN via the Internet. IP Mapping is most suitable to fixed or static IP addressing.

1. To enable IP Mapping, from the General Settings dialog box, select **Enable IP Mapping**, then click **IP Mapping (Virtual Server)**.
2. The Virtual Server Mapping dialog box appears.

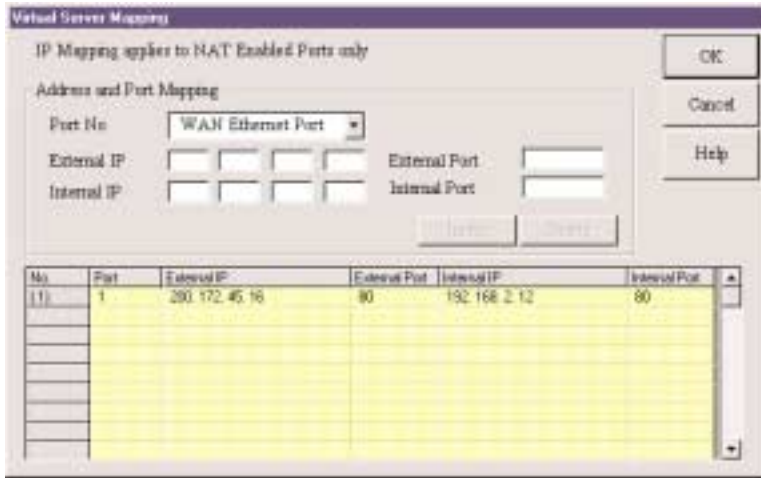

**Figure 6-8. Virtual Server Mapping.**

For each service you'd like to set up:

1. Use the Port No. field to select either the **WAN** or **Async (Serial) port**.
2. Enter the IP address supplied by your ISP in the External IP field. If your ISP uses dynamic IP addressing, set this field to **0.0.0.0**. Your device will use the dynamically assigned address when connecting to your ISP.
3. Enter the TCP/IP port number for the service that you will be using for IP mapping. Common TCP/IP port numbers are listed below:

WWW	Port 80
FTP	Port 20 or 21
SMTP	Port 25
POP3	Port 110

For more information on port numbers, visit <http://www.metadigm.co.uk/>.

If you would like to map all services for this external IP address to a computer on your LAN, you can enter port number 0. This means that whenever anyone accesses your external IP address, they will automatically be “mapped” to the internal computer that you specify, regardless of what port number they are using.

4. Enter the Internal IP address of the server to which you want to map the External IP address.



5. Enter the port number for the service that you will be using for this IP mapping. Click **Insert** to include the mapping.
6. Click **OK** when you have completed mapping addresses.

## NOTE

IP Mapping function allows you to have only one port service on your LAN. For example, if you map an external IP (16.895.1.3) to an internal IP address (192.168.2.22—a www server), only the internal IP address in your local network can serve as the www.server for the external IP address.

## 6.2 Port Settings

The Modem Settings options are used to configure the communication between your modem or ISDN TA and your Router serial port. You must specify the baud rate, modem, and modem string settings for your device.

1. To view or change the port settings, from the main Manager dialog box, click **Port Settings**. The Port Settings dialog box appears.

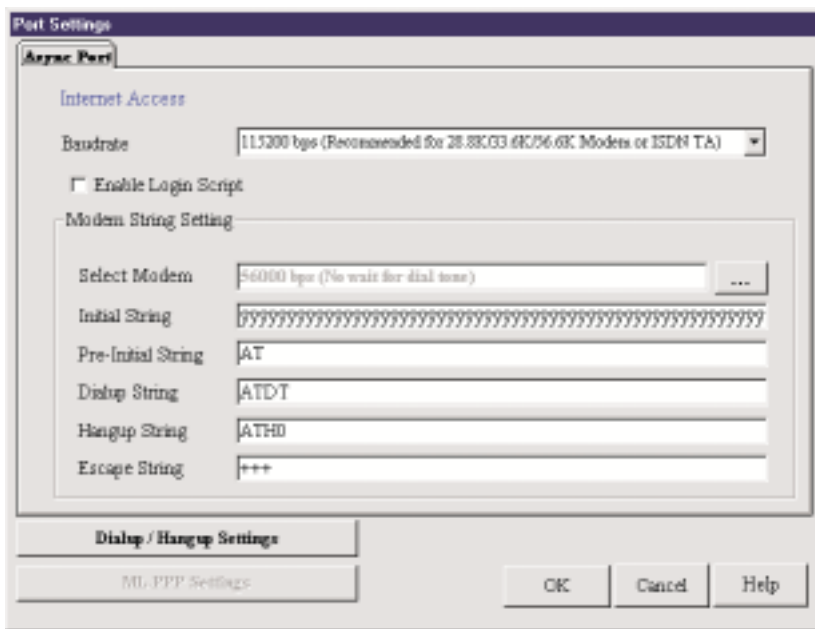

**Figure 6-9. Port Settings.**

2. Complete the fields as follows:

Baud rate: Use the list to select the Remote Access DTE speed for your device.

The absolute maximum setting for a given port on the network device is 4 x the speed of your modem. If the baud rate is set too high, your network device may fail to establish a dial-up connection. For example, if you have a 14.4-kbps modem, the highest speed selected is 57.6 kbps.

If your modem does not appear in the list provided, the Standard Modem selection will work in most cases.

### **IMPORTANT**

If you are using an ISDN Terminal Adapter, refer to the Async to Sync PPP string in the User Manual provided with the device to determine the correct initialization, dialup and hang-up strings.

### **NOTE**

Due to variations in ISP connections and phone line quality, this theoretical maximum speed is not attainable. You may need to set the baud rate at a lower speed.

#### **6.2.1 EDIT LOGIN SCRIPT FOR REMOTE ACCESS**

1. From the Port Settings, Async tab, click **Edit Login Script**.
2. The login Script dialog box appears.

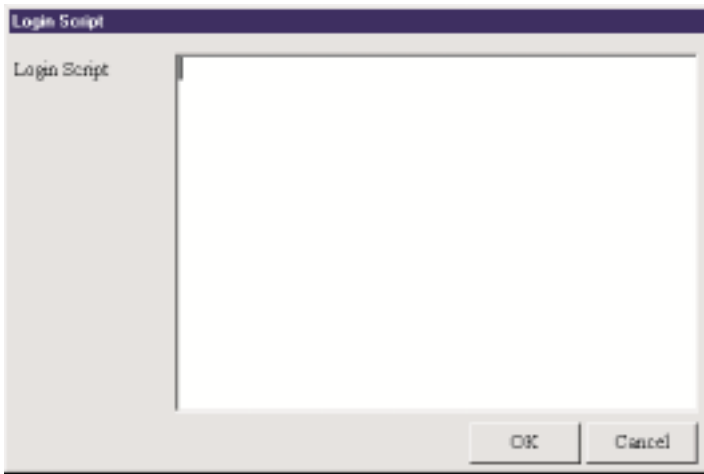

**Figure 6-10. Login Script dialog box.**

A sample remote access login script is shown below. If a remote access client is configured to “bring up a terminal window after dialing,” this remote access login script initiates.

For Remote Access, the device will act as the server side...

**Send ‘Welcome’** displays “**Welcome**” to remote site.

**Send** sends an Enter (Carriage return + line feed) to the remote site.

“**Send Username**” prompts the remote site for a user name.

“**Retrieve 1**” will wait for the remote site to enter the user name that will be used for PPP authentication.

“**Send Password**” prompts the user for a password.

“**Retrieve 2**” will wait for the remote site to enter a password.

“**Verify 3**” instructs the device move to login script line 3 if PPP authentication fails.

“**Go**” means start PPP protocol.

**Writing a Login Script for IP Routing**

To write an effective login script, you must obtain the correct login script information from your ISP and become familiar with using the login script commands.

Every ISP has a unique login interface screen. Check with your ISP to determine how your ISP requests information from you when using a PPP connection.

**NOTE**

You can create a simple dial-up connection to view your ISP interface log-in screen using Dial-Up Networking in Windows 95, 98, NT, or 2000.

Some common commands are:

**Send and SH**

Send "ATZ"

Send "ATDT 888-1234"

Send "JaneDoe"

SH '1234'

Send ""

**FUNCTION**

Resets the Modem

Dials the phone number "888-1234"

Types "JaneDoe" at the ISP interface

Types "1234" at the ISP interface but displays \*\*\*\* on the Broadband Monitor to hide the password.

Sends Enter (carriage return plus line feed) to the ISP

**Wait**

Wait 5

Wait "CONNECT"

Wait "CONNECT 6"

**FUNCTION**

The Modem will wait for 5 seconds before moving the next line in the login script.

The Modem will wait for CONNECT to display before moving to the next command.

Modem will wait for "CONNECT" to display before moving to the next command. If CONNECT does not display, the modem will go to line 6 of the login script.

**Other**

Go

Jump4

Hangup

**FUNCTION**

Begins PPP

Goes back to line 4 of the login script.

Hangs up the modem.

**Example 1: Script for Normal Reliable ISP**

#	Login Script	Meaning of Each Login Script Command
1	Send"ATZ"	Rests Modem
2	Send"ATS0 =1"	Sends initial string 'ATS0 =1' to modem
3	Send"ATDT888-1234"	Dial phone number 888-1234
4	Wait"CONNECT"	Waits for ISP to send reply 'CONNECT'
5	Wait"username:"	Waits for ISP to send reply 'username'
6	Send"JaneDoe"	Sends the user name 'JaneDoe' to the ISP
7	Wait"password"	Waits for ISP to send reply 'password'
8	SH"1234"	Sends password '1234' to the ISP
9	Wait"====>"	Waits for ISP to send reply '====>'
10	Send"1"	Selects option 1 (PPP) for this ISP
11	Go	Starts PPP mode

**Example 2 : Script for Unreliable ISP (Redial until connected)**

#	Login Script	Meaning of Each Login Script Command
1	Send"ATZ"	Resets modem
2	Send"ATS0 =1"	Sends initial string 'ATS0 =1' to modem
3	Send"ATDT8881234"	Dials phone number 888-1234
4	Wait"CONNECT"2	Wait for ISP to send reply 'CONNECT'. If no CONNECT, returns to line 2 to re-dial.
5	Wait"username:"12	Waits for ISP to send reply 'username'. If no response, goes to line 12.
6	Send"JaneDoe"	Sends the username 'JaneDoe' to the ISP
7	Wait"password"	Waits for ISP to send reply 'password'
8	SH"1234"	Sends password '1234' to ISP
9	Wait"====>"	Waits for ISP to send reply '====>'
10	Send"1"	Selects option 1 (PPP) for this ISP
11	Go	Starts PPP mode
12	Hangup	Hangs up Modem

**Example 3 : Script for Unreliable ISP (2nd ISP backup)**

#	Login Script	Meaning of Each Login Script Command
1	Send“ATZ”	Resets modem
2	Send“ATS0 =1”	Sends initial string ‘ATS0 =1’ to modem
3	Send“ATDT8881234”	Dials phone number 888-1234
4	Wait“CONNECT” 12	Waits for ISP to send reply ‘CONNECT’. If no reply, goes to line 12 for ISP #2.
5	Wait “username:” 12	Waits for ISP to send reply ‘username’. If no response, goes to line 12 for ISP #2.
6	Send“JaneDoe”	Sends the username ‘JaneDoe’ to ISP
7	Wait“password”	Waits for ISP to send reply ‘password’
8	SH“1234”	Sends password ‘1234’ to ISP
9	Wait“====>”	Waits for ISP to send reply ‘====>’
10	Send“1”	Selects option 1 (PPP) for this ISP
11	Go	Starts PPP mode (Rest of script ignored)
12	Hangup	Hangs up Modem
13	Send “AT S0=1”	Sends initial string ‘AT SO=1’ to modem
14	Send “ATDT 8885678”	Dials phone number 888-5678 (ISP #2)
15	Wait “Connect” 23	Waits for ISP to send reply ‘CONNECT’. If no CONNECT, goes to line 23.
16	Wait “username:” 23	Waits for ISP to send reply ‘username’. If no response, goes to line 23.
17	Send “Stephen”	Sends the username ‘Stephen’ to ISP
18	Wait “password:”	Waits for the ISP to send ‘password:’
19	SH “5678”	Sends password ‘5678’ to ISP
20	Wait“====>”	Waits for ISP to send reply ‘====>’
21	Send“1”	Selects option 1 (PPP) for this ISP
22	Go	Starts PPP mode
23	Hangup	Hangs up Modem
24	Jump 2	Goes back to line 2 to re-dial ISP#1

**6.2.2 MODEM STRING SETTINGS**

The most important modem string is the initialization string because your network device uses it to establish communications with your modem or ISDN TA. The modem initialization string displayed is the modem or ISDN TA initialization string entered in the Setup Wizard. For most analog modems, the Standard Modem selection will work. For additional information, refer to the Modem Settings information presented in **Chapter 4**.

## IMPORTANT

There is no standard ISDN TA initialization string. If your ISDN TA is not included in the modem list, check your ISDN TA User's Guide for information for the initialization string for an Asynchronous to Synchronous PPP connection. If you are using only one channel of your ISDN connection, you can enter the Async to Sync PPP initialization string. If you are bundling your connection channels, you'll need to use a Multilink-PPP initialization string. You must also enter the two phone numbers in the Telephone Number field of the General Settings dialog box. Also verify that your ISDN TA supports the dial-up string ATDT. Most ISDN TAs support ATDT, but some support ATD or ATDI.

### 6.2.3 DIAL-UP/HANG-UP SETTINGS

The Dial-up/Hang-up settings allow you to specify your connection time (idle timeout or auto reconnect) and the number of times to attempt to connect (if connection cannot be established).

1. From the main Manager dialog box, click **Port Settings**.
2. From the Async tab, click **Dial-up/Hang-up Settings**.

#### *Individual Port Options*

Individual Port Options lets you set the idle-timeout function for each serial port on the Router. You can set the number of minutes you wish to allow a connection to stay idle before disconnection.

## NOTE

**Default idle timeout for IP Routing is 5 minutes. Default idle timeout for Remote Access is 30 minutes.**

If you un-check the idle-timeout, once a client establishes a connection, the connection will be maintained until you turn off your modem, unplug your network device, or use the Terminate Connection function in the Broadband Monitor program.

The Automatic Reconnect (Always connect) essentially maintains your connection (for example, idle time out = infinite). If the connection is disconnected for any reason, it will automatically attempt to reconnect.

#### *Dial-up Retry Options*

The Dial-Up Retry option allows you to specify the number of times the Router should attempt to establish a connection.

If the retry count is 0, the device will not dial-out to connect to the remote site.

### NOTE

Automatic Reconnect will override the Retry count setting if retry count is set to 0.

## 6.3 LAN DHCP Server

### NOTE

Refer to the Glossary in Appendix B for more information about the DHCP function.

1. From the main Manager dialog box, click **LAN DHCP Server**.

### NOTE

The LAN DHCP Server option indicates if DHCP is Enabled or Disabled. By default the DHCP function is Enabled. To Disable the function, you must open the DHCP Configuration dialog box, select Disabled and click OK.

2. The DHCP Configuration dialog box appears.

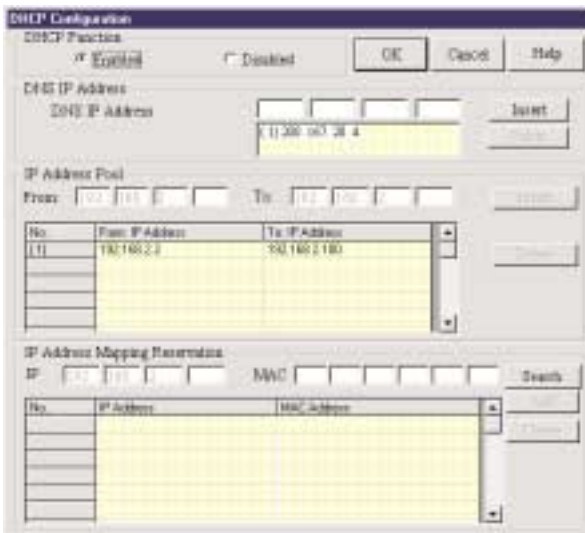

Figure 6-11. DHCP Configuration dialog box.



3. Complete the following information:

DNS IP Address:

Enter the ISP's DNS IP address. You may enter up to four ISP DNS IP addresses. Click **Insert**.

### **6.3.1 IP ADDRESS POOL**

The IP Address Pool contains the range of IP addresses that will be automatically assigned to the clients of your network as they connect to the network.

#### **NOTE**

**By default, the IP address pool range is from 100 to 200. Ranges are listed in the IP Address Pool table.**

To change the range:

1. Select the existing range of addresses.
2. Enter a new range.
3. Press **Insert**.

To delete an IP Address range:

1. Select the range of addresses.
2. Press **Delete**.

### **6.3.2 IP ADDRESS MAPPING RESERVATION**

You can use the IP Address Mapping Reservation option to give a static IP address to particular computers on your network. Each time a computer is powered on and connects to the network, it will receive the same IP address. Static IP addresses are frequently assigned to network resources such as printers, servers, hubs, and routers that are consistently shared by network clients.

To assign a static IP Address:

Enter the MAC address manually or use the MAC address search tool.

To use the MAC address search tool:

1. Enter the IP address of the computer.
2. Click **Search** to find the MAC address.
3. Once the address has been located, click Add to reserve the address.

To delete a static IP Address:

1. Select the static address you would like to delete.
2. Click **Delete**.

**NOTE**

Refer to the Appendix C for information about determining a computer's netmask address.

**6.4 Routing Settings**

Routing is the process of moving a packet of data from source to destination. The router enables messages to pass from one computer to another and eventually reach the target machine. Part of this process involves analyzing a routing table to determine the best path. Use the information below to create a routing table to connect your network to another network, or to connect subnets within your network.

**NOTE**

A routing table is required to use the LAN-to-LAN routing function of the Router.

1. From the main Manager dialog box, select **Routing Settings**.
2. The Routing Settings dialog box appears.

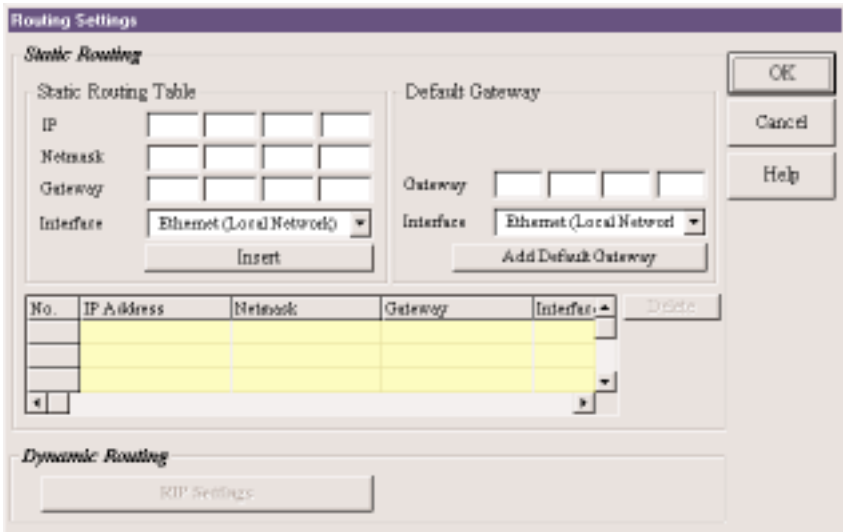

**Figure 6-12.** Routing Settings dialog box.

## ROUTING

For each different subnet on your LAN, enter:

**IP:** Enter the (network/subnet) IP address to which you want to route.

**Netmask:** Enter the subnet mask of your Network IP address.

**Gateway:** Enter the IP address of the gateway device linking your network to the other network/subnet. The IP address should be in the same subnet as your Router. If you are using this device with the LAN-to-LAN function, the gateway IP should be set as the IP address of the Router.

**Interface:** Select the port (LAN or WAN, etc.) that the routed packet should pass through. Select Local Network if you are using a separate router. If you are using the Router with the LAN-to-LAN function, the Interface should be set as the WAN port that connects you to the other subnet.

Click **Insert** to save the information to the routing table.

To delete this information, select it from the routing table and click **Delete**.

**Default Gateway:** Default gateway is an IP address that all packets are routed to, when the device is unable to find a route match (the destination IP address of the packet in the routing table).

Click **Add Default Gateway** to save the IP address of the default gateway.

**Interface:** Select the port (LAN or WAN, etc.) interface where the gateway is located.

### ***Routing Table***

The routing table stores the routing information so that the Router knows how to route the IP packets to the proper network.

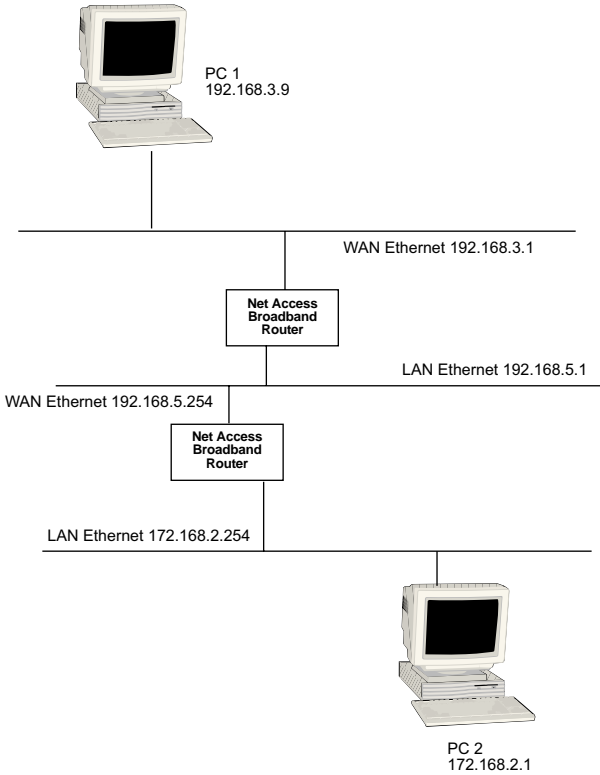

**Figure 6-13. Routing.**

### What is the purpose of the routing table?

In the diagram above, the Router has the routing information to route between 192.168.3.x and 192.168.5.x. The device does not have the information about how to route to the 172.168.2.x network. If you want the Router to route to 172.168.2.x, you must add the following information to the routing table:

IP:	172.168.2.0
Network:	255.255.255.0
Gateway IP:	192.168.5.254
Interface:	Ethernet (Local Network)

If you would like the Router to route to 192.168.3.x, enter the following routing table information into the Routing settings:

IP: 192.168.3.0  
 Network: 255.255.255.0  
 Gateway IP: 192.168.5.1  
 Interface: WAN Ethernet

## 6.5 Filter Settings

You can use Filter Settings to choose which packets are allowed to enter the network and which packets will be blocked. Filter Settings can be used to filter network services such as Mail, WWW, FTP, Telnet, and News.

1. From the main Manager dialog box, select your Router, then **Filter Settings**.
2. The Filter Settings dialog box appears.

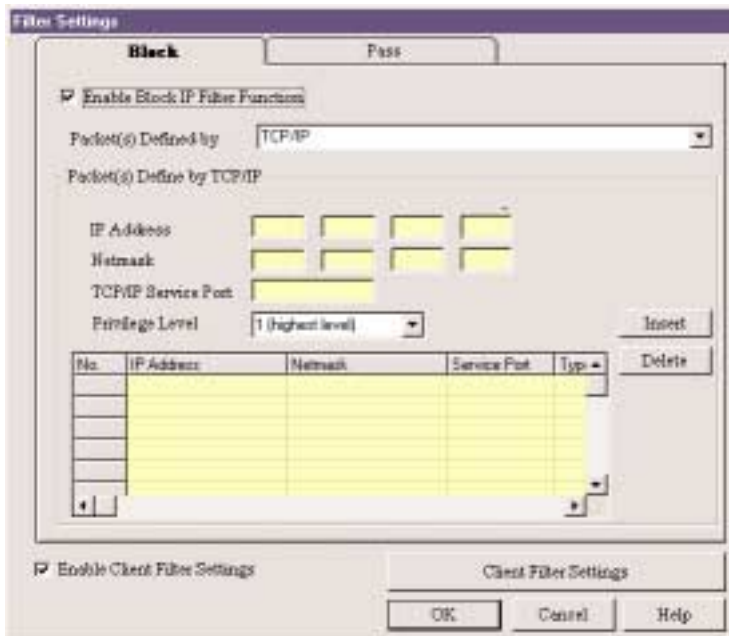

**Figure 6-14. Filter Settings dialog box.**

3. Select the Block tab or the Pass tab to define your filtering.
  - The Block function filters by blocking packets from going out the WAN port or coming in through the LAN port. To enable the Block IP filter function, select **Enable Block IP Filter Function**.
  - The Pass function filters by defining which packets can go into your WAN port or come on to your LAN. To enable the Pass IP filter function, click the Pass tab and select Enable Pass IP Filter Function.
4. To filter packets to be passed or blocked, use the Packets Defined By list to select TCP/IP or User.

Packets Defined by TCP/IP:

If you choose to define by TCP/IP, you must enter the packet IP information.

IP Address:

Enter the IP address of the packet to be Blocked or allowed to Pass.

Netmask:

Enter the subnet mask for the packet.

TCP/IP Service Port:

Enter the Socket Port you would like to block or allow to pass (for example, HTTP= 80)

### ***Privilege Level***

Use the Privilege list box to select an appropriate level for this filter.

It is common to set many filter rules for a particular client. At times, the rules you have set may conflict with one another. When a conflict occurs, the filter with the higher privilege level will override the other filter(s).

## **NOTE**

**Level one is the highest level, level sixteen is the lowest privilege level.**

For example, let's say you configure a filter rule for IP address 192.168.100.72 with a privilege level of 16 to Pass using socket number 80. At the same time, you set the same filter rule to block IP Address 192.168.100.72 with a privilege level of one. The Router will implement the filter to block the IP address 192.168.100.72 because the privilege level is higher.

## NOTE

If conflicting rules have the same privilege level, then the Router will block the packet.

Click **Insert** to add each IP address to the list.

To remove a defined packet, select the packet you'd like to delete from the table and click **Delete**.

### Packets defined by User:

If you choose to define by User, you must define the byte pattern of the packet(s). The Router uses the defined byte patterns to block or pass packets from the WAN or from the LAN.

1. In the Block dialog box, select **Enable Block User Defined Pattern Function**.
2. In the Packets defined by User field, select **From LAN** or **From WAN**.

Starting from which byte number: In this field, indicate the first byte in the packet the Router should read to determine if the byte pattern (in Hex) is one that should be filtered. Exclude the PPP header. Start from byte 0 of the network protocol.

Byte Pattern (in Hex): Enter the packet byte pattern that you would like the Router to recognize as a packet to be filtered. (Block/Pass from the WAN to the LAN). The maximum pattern size is 12 bytes.

Click **Insert** to add each byte pattern to the table.

To delete a defined packet, select the packet in the table and click Delete.

### ENABLE CLIENT FILTER SETTINGS

The Client Filter allows you to decide which services are allowed into your network and which clients are authorized to access them.

1. From the Filter Settings dialog box, select **Enable Client Filter Settings**.
2. Click **Client Filter Settings**.
3. The Filter Settings dialog box appears.

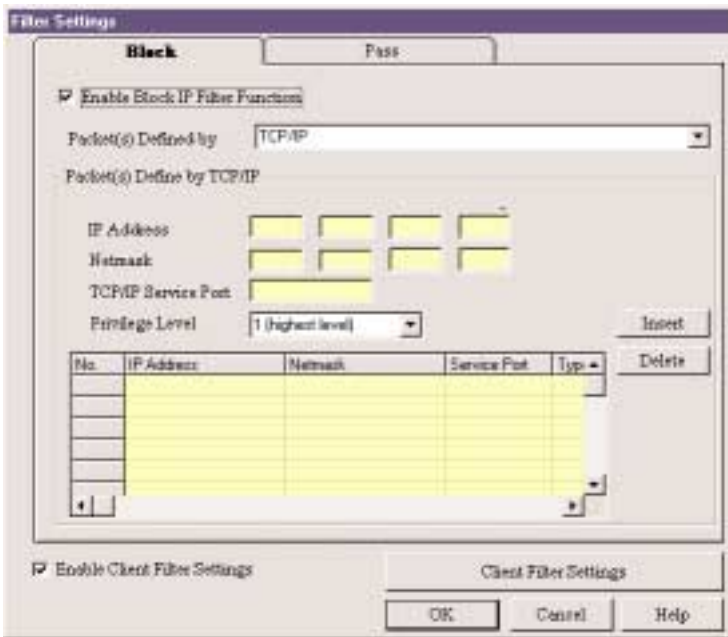

**Figure 6-15. Filter Settings dialog box.**

The filter works by filtering TCP/IP port numbers. The five most commonly used port numbers are listed for you. They include the port numbers for Mail, WWW, FTP, Telnet, and News. If you would like to filter other services, you must know the port number for the service.

4. Click **Edit** to enter new service port numbers.
5. Enter the TCP/UDP Port Number and click **Add**.

### NOTE

Refer to Appendix C for a definition of Port.

6. Click **Privileged Clients**.
7. The Privileged Client Table dialog box appears.



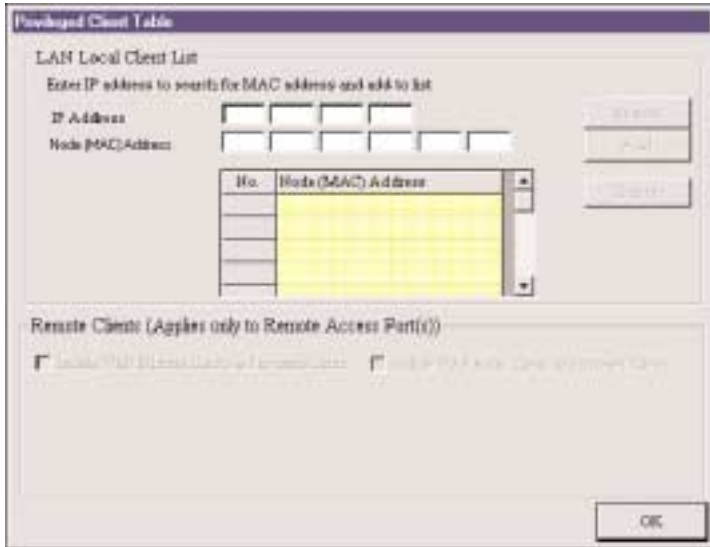

**Figure 6-16. Privileged Client Table dialog box.**

#### *LAN Local Client List*

In the Privileged Client Table, enter the clients you wish to have privileged access to the services that you have selected in the Filter Settings dialog box. The filter uses MAC addresses to identify the privileged clients. You can enter the MAC address directly or you can use the MAC address search tool by entering the IP address of the computer, then using the Search button to find the MAC address.

After completing the IP Address and MAC (Node) address, click Add to include the information in the Node (MAC) address list.

#### *Remote Clients*

(Applies to Remote Access Port[s])

Select **Include WAN Async Clients as Privileged Clients** or **Include WAN Ethernet Clients as privileged clients** to filter Remote Clients by the port they are coming in through.

8. Click **OK** when complete.

## 6.6 Refresh Device List

From the main Manager dialog box, click **Refresh Device List** to search the LAN for available network devices and display them in the Available Devices list.

### NOTE

If a device does not appear in the list, click Refresh Device List again to determine if the device will appear on the list. If the device still does not appear, ensure that all cables are correctly connected and that the Router is powered on. If the device still does not appear in the list, refer to Chapter 10.

## 6.7 Device Name and Password

1. From the main Manager dialog box, click **Device Name and Password**. You may use the default device name or use this dialog box to change the name or add a password for your device.

The screenshot shows a dialog box titled "Device Name and Password". It features four text input fields stacked vertically. The first field, labeled "Device Name:", contains the text "LRB500A". The second field is labeled "Domain Name". The third field is labeled "Device Password". The fourth field is labeled "Password Verification". To the right of the "Device Name" field is an "OK" button. To the right of the "Domain Name" field is a "Cancel" button.

**Figure 6-17. Device Name and Password screen.**

**Device Name:** This field displays the name of your network device. To change the name, simply enter a new name in the field. If you are connecting to an ISP via cable modem or DSL, and your ISP requires you to enter a computer name, you may use the device name that you've entered on this screen.

**Domain Name:** Enter your local network domain name in this field.

**Device Password:** The Broadband Manager does not come with a password enabled. If you choose to provide the device with a password, you will be prompted to enter the password each time you want to configure your network device. To enter a Password, type your password in the Device Password field, then re-enter your password in the Password Verification field.

## NOTE

If you choose to use a password, make sure you have selected something that will be easy to remember, or write it down and store it in a safe location. If you have completely forgotten your password, contact Black Box Technical Support for assistance. Refer to Chapter 10 for more information about calling Technical Support.

2. Click **OK**.

## 6.8 Save Settings to File

The Save Settings to File option allows you to save your settings to a file. This option provides a method for backing up your system configuration so that it can be used in the event your settings become accidentally deleted. This option can also be used if you would like to have more than one set of settings for your Router.

1. From the main Manager dialog box, click **Save Settings to File**.
2. The Save Settings to File dialog box appears.



**Figure 6-18. Save Settings to File dialog box.**

To save your settings to a file:

1. In the File Name field, enter a name for your file.

### NOTE

**Do not change the file type extension. If you try to use the Load Settings function, the manager program will look for the specific file extension compatible with your device. For example, \*.co1 is used only for 1 WAN port units, \*.co2 is used only for 2 WAN port units.**

2. The File Directory field displays the default path to the configuration files. You may save a copy of the file to a different location by changing the path in the File Directory field.
3. Press **OK** to save the settings to the file name specified in step 1.

## 6.9 Load Settings

The Load Settings option allows you to load either the default settings of your network device or to load settings previously saved to a file.

1. From the main Manager dialog box, click **Load Settings**.
2. The Load Settings dialog box appears.



**Figure 6-19. Load Settings dialog box.**

3. To return the Router to factory-default settings, select **Load Default Setting**.
4. To load a configuration from a file, select **Load Settings From File**.
  - In the File Name field, enter the name of the file containing the settings you would like to use.
  - Indicate the location of the file by entering the full path to the file in the File Directory field.
  - Select the file from the Available Files table.
5. Press **OK** to load and apply the settings to the Router.

## 6.10 Upgrade Firmware

### WARNING

Upgrade the firmware of your Router only under the advice and direction of Black Box Technical Support (call 724-746-5500). Improperly upgrading the Router may disable the device.

The Upgrade Firmware options allow you to upgrade your Router firmware. The Upgrade Firmware option upgrades the firmware of your Router, not the Broadband Manager or Monitor software.

1. From the main Manager dialog box, click **Upgrade Firmware**.
2. The Upgrade Firmware dialog box appears.

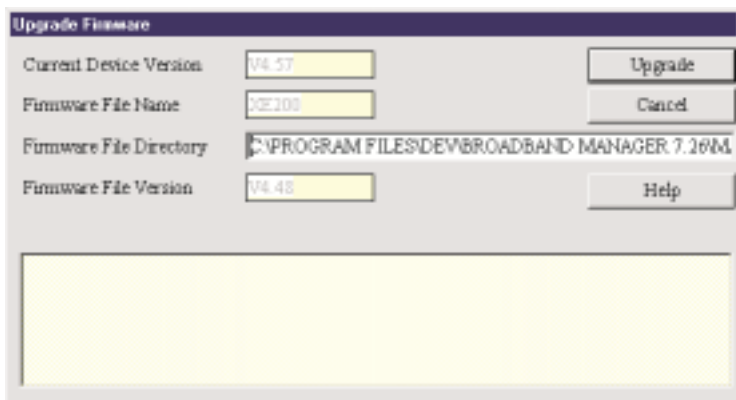

**Figure 6-20. Upgrade Firmware dialog box.**

**To Upgrade your firmware:**

1. Download the latest firmware from the Black Box Web site at [www.multitech.com](http://www.multitech.com) (*www.blackbox.com*).
2. Copy the firmware to the directory containing the Broadband Manager program files. Refer to the default Firmware File Directory field to determine the location of the files on your system.
3. Enter the location of the new firmware file in the Firmware File Directory field. Broadband Manager will automatically detect the new firmware file name and display it in the Firmware File Name field. The version number of your firmware will display in the Firmware File Version field.
4. Click **Upgrade** to upgrade your firmware.
5. A message appears stating the upgrade has started.
6. After several minutes, an informational dialog box displays indicating the upgrade was successful.
7. Click **OK**.
8. From the main Manager dialog box, click **Save and Exit**.
9. Click **Yes** to restart the Router using the new firmware version.

**6.11 General Diagnostic**

The General Diagnostic option on the main Broadband Manager dialog box displays network device information and allows you to determine if the Router is functioning properly.

1. From the main Manager dialog box, click **General Diagnostic**.
2. The General Diagnostic dialog box displays information about the Router.

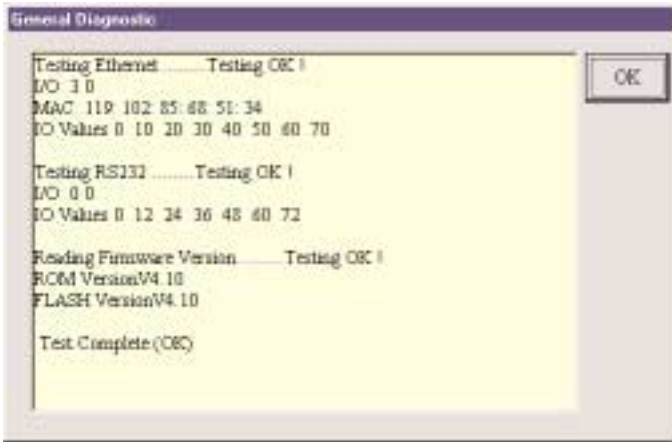

**Figure 6-21. General Diagnostic dialog box.**

3. Record the information if necessary and click **OK** to exit.

# 7. Broadband Monitor

Broadband Monitor is a utility that provides both monitoring and troubleshooting functions.

## 7.1 Running Broadband Monitor

1. Click on the Broadband Monitor icon, or select **Start, Programs, Broadband Manager, Broadband Monitor**.
2. The Broadband Monitor dialog box appears.

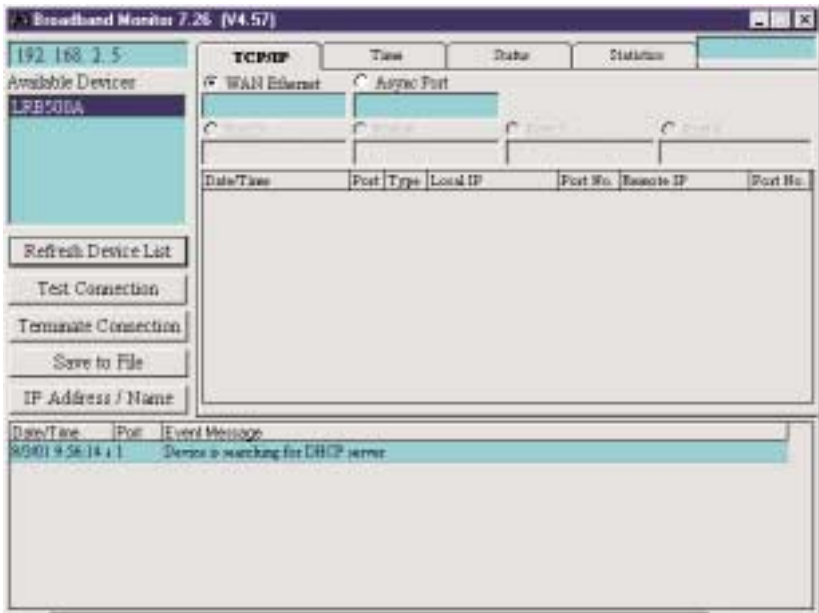

**Figure 7-1. Broadband Monitor dialog box.**

### NOTE

If you receive a message stating “Device is not found”, refer to Chapter 10.

## 7.2 Refresh Device List

Click **Refresh Device List** from the main Broadband Monitor dialog box to display a list of network devices in the Available Devices window.



### 7.3 Test Connection

The Test Connection option tests your connection settings and assists you in determining if problems are due to the modem, the Router, or an incorrect setting. Test Connection uses the attached modem(s) to dial-up the remote server (ISP) and establish a connection.

1. From the main Broadband Monitor dialog box, click **Test Connection** to begin testing.
2. The Test Connection dialog box appears.

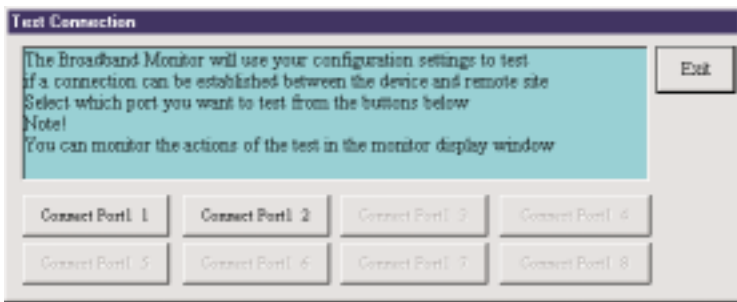

**Figure 7-2. Test Connection dialog box.**

3. Select **Connect Port 1** to test the WAN connection, or **Connect Port 2** to test the Async connection.
4. The monitor display window displays the actions of the test.
5. To terminate the connection, refer to the Terminate Connection instructions which follow.
6. Click **Exit** to close the Test Connection dialog box.

## 7.4 Terminate Connection

The Terminate Connection option is designed to allow the Network Administrator to terminate a Router connection instantly.

1. From the main Broadband Monitor dialog box, select **Terminate Connection**.
2. The Terminate Connection dialog box appears.



**Figure 7-3. Terminate Connection screen.**

3. Select **Disconnect Port 1** or **Disconnect Port 2**.
4. Click **Terminate Connection**.
5. Click **Exit** to return to the Broadband Monitor dialog box.

## 7.5 Save to File

Click **Save to a File** to save a monitoring session to a file. This feature can be used to create an event log to send to Black Box Technical Support for evaluation.

1. From the main Broadband Monitor dialog box, select **Save to File**.
2. The Save Log Files dialog box appears.

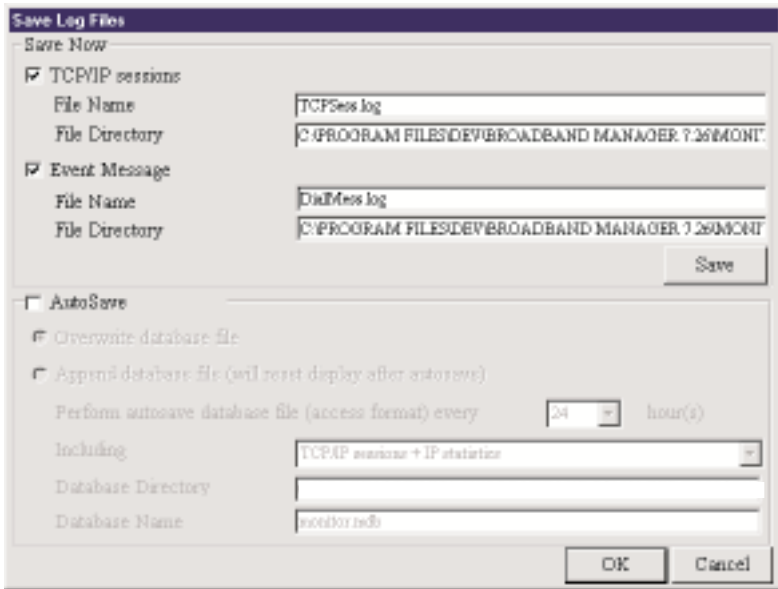

**Figure 7-4. Save Log Files dialog box.**

### SAVE NOW

If you want to save the monitor display at any point in time, select the monitor you'd like to save to a file (TCP/IP, Event Message, etc.). Select the File Name and File Directory to which you'd like to save the file and click **Save**.

### AUTO SAVE

If you wish to automatically save the information displayed on the monitor to a database file, enable the AutoSave function. Options for this function include:

#### **Overwrite database file**

This option saves the information collected by the monitor to a database file based on the time interval that you specify, overwriting the last saved database file.

#### **Append Database file**

This option saves the information collected by the monitor to a database file based on the time interval that you specify, updating and appending to the file.

**NOTE**

The Append Database file option will reset the monitor and clear the screens after the autosave has appended the information to the file.

**WARNING**

The database size limit is equal to the amount of available disk space. Use this option with caution.

3. Click **OK** when complete.

**7.6 IP Address/Name**

The IP Address/Name function allows you to associate a name with a particular IP address and name on your network. This information will appear in the relevant monitor displays. The IP Address/Name option is used to assist the Network Administrator in determining which users are transmitting and receiving data without having to remember their specific IP addresses.

Each computer listed must have a fixed IP address for your network. You may configure a fixed IP address on the individual computer or use the Router's DHCP server IP reservation system (refer to the LAN DHCP section of Broadband Manager chapter of this User Guide).

1. From the main Broadband Monitor dialog box, click **IP Address/Name**.
2. The IP User Mapping dialog box appears.

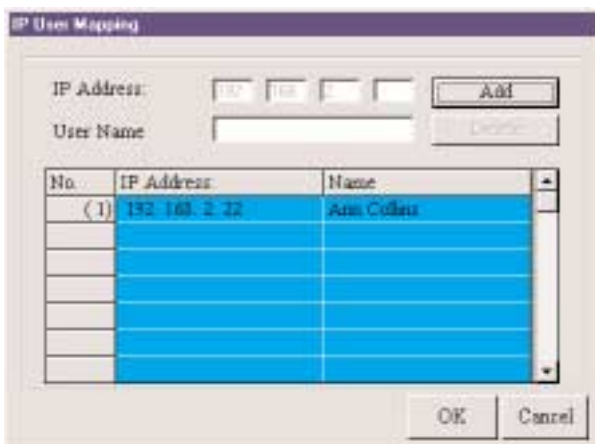

**Figure 7.5.** IP User Mapping dialog box.

3. Enter each computer's IP Address and associated User Name in the provided fields.
4. Click **Add** after each IP address and name have been added to the list.
5. When all addresses have been added, click **OK**.

## 7.7 Event Messages

Event Messages are displayed in the lower half of the Broadband Monitor display. Event Messages provide information about the communication occurring between your network device, ISDN TA/modem, and the remote server (ISP).

To assist you in troubleshooting, you may point and click on any event message to bring up a help screen.

## 7.8 TCP/IP Tab

The TCP/IP tab displays all TCP/IP requests made by your network device. You may select to view TCP/IP sessions for the WAN Ethernet or the Async Port.

1. The TCP/IP tab is the default tab displayed in the Broadband Monitor dialog box. If it is not displayed, click the TCP/IP tab.

### NOTE

**The TCP/IP session displays the history of the TCP/IP session through the selected port. The TCP/IP information presented does not represent the current status of the TCP/IP session.**

The TCP/IP tab displays the following information:

Date/Time:	Indicates the date the request was made.
Port:	Indicates the port you are viewing.
Type:	Displays the type of request being made.
Local IP:	Indicates which IP address you have requested information from.
Remote IP:	Indicates which IP address was requested.
Port Number:	Indicates which TCP/IP port was requested.

2. To Exit Broadband Monitor, close the window.

## 7.9 Time Tab

The Time Tab provides information about the amount of time the device has been powered on, the total connection time, the current connection time, and the amount of data transferred and received.

1. From the main Broadband Monitor dialog box, click the **Time** tab.
2. The Time tab displays information for each port.

The screenshot shows the 'Time' tab in the Broadband Monitor dialog box. It displays the device power on time as 'Wed Jul 05 16:08:29 2000'. Below this is a table with two columns: 'Port' and 'Power-On Time'. The table has two rows of data, both showing '17:54:20' for the power-on time. The table also includes columns for 'Total Connection', 'Current Connection', 'Tx Bytes', and 'Rx Bytes', all showing '00:00:00' and '0' respectively.

Port	Power-On Time	Total Connection	Current Connection	Tx Bytes	Rx Bytes
1	17:54:20	00:00:00	00:00:00	0	0
2	17:54:20	00:00:00	00:00:00	0	0

**Figure 7-6. Time tab.**

**Device Power Turned On:** This field displays the time/date that your Router was powered on.

**Power-On-Time:** This field displays the total time that has elapsed since your Broadband was powered on.

**Total Connection Time:** This field displays the total connection time for each port that has been logged on since the Router was powered on.

**Current Connection:** This field displays the time that has elapsed since the current connection was established for the port.

**TX Bytes:** This field displays the total number of bytes transmitted for each port since your Router was last powered on.

**RX Bytes:** This field displays the total number of bytes received for each port since your Router was last powered on.

3. To Exit Broadband Monitor, close the window.

## 7.10 Status Tab

The Status tab provides information about the status of the WAN Ethernet and Async ports.

1. From the Broadband Monitor dialog box, click the **Status** tab.
2. The Status tab information appears.



**Figure 7-7. Status tab.**

### WAN ETHERNET

This indicator light shows that either the IP Routing or the Remote Access function is in use.

### ASYNC PORT

**Modem Power:** The indicator light is lit when the modem power is turned on.

**Modem Ready:** The Network Device sends a pre-initialization and initialization command to the modem or ISDN TA. If this communication is successful, the indicator light will be lit, indicating your modem is ready to make a connection.

**Modem Connected:** If the Network Device has detected that your modem has successfully dialed up a connection to a remote site, the indicator light will be lit.

**PPP Connected:** After a connection is established, if the Router has detected that the PPP connection is successful, this indicator light will be lit.

3. To Exit Broadband Monitor, close the window.

## 7.11 Statistics Tab

The Statistics tab indicates, by port, how many bytes of data have come in and out through the Router.

1. From the Broadband Monitor dialog box, click the **Statistics** tab.
2. The Statistics tab dialog box appears.

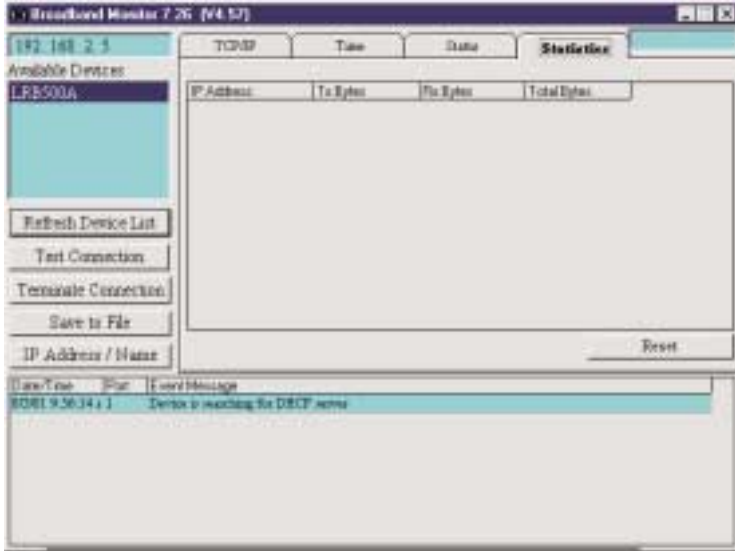

**Figure 7-8. Statistics tab.**

3. You may view the following information:

**IP Address:** The IP address of the network device.

**Name:** The Name as entered in the IP/Address name option of the Main Broadband Monitor dialog box.

**Tx Bytes:** Displays the number of bytes transmitted from the computer with this IP address.

**Rx Bytes:** Displays the number of bytes received from the computer with this IP address.

**Total Bytes:** Displays the total number of bytes received and transmitted from the computer with this IP address.



4. Use the Reset button to set the IP statistics to zero.
5. To Exit Broadband Monitor, close the window.

## 8. LAN Client Settings

In order for a computer to access the Internet, the TCP/IP protocol must be installed on the computer. Computers on your local LAN as well as computers dialing in to your network may use dynamic or static IP addresses. Dynamic IP addresses may be automatically assigned by the DHCP function of the Router or another DHCP server. Static IP addresses can either be reserved from the DHCP server or manually configured on the individual workstation.

To install or verify that TCP/IP is installed on your workstations, click **Start, Settings, Control Panel, Network**, then view the Protocol information. If the TCP/IP protocol is not installed on your workstations, you must add it. Refer to your Windows documentation for assistance in adding the protocol.

The default setting in Windows is to have IP information (IP Address, DNS Server IP address, and Gateway IP address) automatically assigned by a DHCP server such as the one built into your Router.

If you'd like to manually configure the IP addresses on your workstation, you will need to provide an IP address and subnet mask (the local LAN IP address and subnet you want to assign to the individual computer), a Gateway address (the local LAN IP address of your Router), and a DNS Server address (the DNS IP address provided by your ISP).

### WARNING

As a general rule, you should have only one DHCP server working on your network. If you decide to use a DHCP server other than that provided with your Router, you should use **Broadband Manager** to disable the DHCP LAN Server function. You should also set your Router's IP address as the gateway to the other DHCP server.

### 8.1 Setting Up Remote Access Clients

Dial-in connections to Windows NT, Novell®, and Unix® servers require slightly different configurations. This section discusses the settings necessary to connect a Windows 95/98/NT/2000 workstation to these various servers.

### NOTE

The Windows 2000 operating system has a **Network Connection Wizard** for making new connections.

The basic process consists of installing a dial-up adapter and a network protocol. Then, depending on the server to which you are connecting, you will likely need to install client software and specify the particular services you would like to use.

## 8.2 Accessing a Windows NT Server

Windows NT Server combines the best aspects of an application server, a file and printer server, a communications server, and a Web server. Its interoperability and management features make it an excellent network operating system (NOS) for organizations, whether they have mixed computing environments or operate entirely on Windows NT Server. Perform the following procedures when you need to connect your PC workstation to a remote Windows NT Server.

### 8.2.1 ADDING THE DIAL-UP ADAPTER (NT SERVER CONNECTION)

*Windows 95/98:*

1. Click **Start, Settings, Control Panel**.
2. Double-click the **Network** icon to open the Network dialog box.
3. Click **Add**; the Select Network Component Type dialog box opens.
4. Select **Adapter**, then click **Add**. The Select Network adapters dialog box opens.
5. In the Manufacturers box, select **Microsoft**. In the Network Adapters box, select **Dial-up adapter**.
6. Click **OK** (twice) to return to, and then close, the Network dialog box.

*Windows NT:*

Dial-up Networking adds PPP and SLIP protocol support, enabling your workstation to gain access to a remote computer or network, even if your computer is not on a network.

1. Double-click **My Computer**, then double-click **Dial-Up Networking**. The Dial-Up Networking screen opens.
2. Click **Install**, then follow the onscreen instructions to configure your connection.

### 8.2.2 ADDING TCP/IP (NT SERVER CONNECTION)

*Windows 95/98/NT:*

1. In the Network dialog box, Configuration tab, click **Add**.
2. Select **Protocol** and click **Add**.
3. The Select Network Protocol dialog box opens. In the Manufacturers box [Win95 only], select **Microsoft**. In the Network Protocols box, select **TCP/IP [Win95/98]** or **TCP/IP Protocol [WinNT only]**.

[Note: Windows NT workstation has no Manufacturers box.]

4. Click **OK** (twice) to return to, and then close, the Network dialog box.

### 8.2.3 ADDING CLIENT FOR MICROSOFT® NETWORKS (NT SERVER CONNECTION)

*Windows 95/98:*

1. In the Network dialog box, Configuration tab, click **Add**.
2. Select **Network Client** and click **Add**.
3. The Select Network Client dialog box displays. In the Manufacturer's box, select **Microsoft**. In the Network Clients box, select **Client for Microsoft Networks**.
4. Click **OK** to add this Client and return to the Network dialog box.

### 8.2.4 ADDING FILE AND PRINT SHARING FOR MICROSOFT NETWORKS (NT SERVER CONNECTION)

*Windows 95/98:*

1. In the Network dialog box, Configuration tab, click **Add**.
2. Select **Services** and click **Add**.
3. The Select Network Service dialog box displays. In the Manufacturers box, select **Microsoft**. Select **File and Printer sharing for Microsoft Networks**.

[Note: Windows 98 has no Manufacturers box.]

4. Click **OK** (twice) to return to, and then close, the Network dialog box.

### 8.2.5 SET YOUR PRIMARY NETWORK LOGON (NT SERVER CONNECTION)

*Windows 95/98:*

1. In the Primary Network Logon box on the Configuration tab of the Network dialog box, select (the previously installed) **Client for Microsoft Networks**.
2. Click **OK** to close the Network dialog box.

### 8.2.6 SET-UP PROPERTIES OF COMPONENTS (NT SERVER CONNECTION)

#### ***Dial-Up Adapter***

*Windows 95/98:*

1. In the Network dialog box, Configuration tab, select the **TCP/IP—Dial-Up Adapter**.
2. Click **Properties**. The TCP/IP Properties dialog box opens with the IP Address tab selected.
3. Make sure that **Obtain an IP Address Automatically** is selected. (It's the default.)
4. Click **OK** to close the TCP/IP Properties dialog box.

#### ***Network Client***

*Windows 95/98:*

1. In the Network dialog box, Configuration tab, select **Client for Microsoft Networks**.
2. Click **Properties**. The Client for Microsoft Networks Properties dialog box opens.
3. On the General tab, select **Log on to Windows NT domain**.
4. Click the Windows NT domain field, then enter the name of your Windows NT domain, as provided by your Network Administrator.
5. Click **OK** to return to the Network dialog box.

**Identification**

*Windows 95/98:*

1. In the Network dialog box, select the **Identification** tab.
2. In the Workgroup field, enter the name of your NT domain or the name of your workgroup as provided by your Network Administrator.
3. Enter a name and description for your computer in the fields provided.
4. Click **OK**.

**Access**

*Windows 95/98:*

1. In the Network dialog box, select the **Access Control** tab.
2. In the Control Access to Shared resources using group, select **Share-Level** access control.
3. Click **OK** (twice) to return to, and then close, the Network dialog box.

**NOTE**

**You must restart your system for the new settings to take effect.**

Once your machine has restarted, you may continue the configuration process.

**8.2.7 MAKE YOUR NEW CONNECTION (NT SERVER CONNECTION)**

*Windows 95/98:*

1. Double-click **My Computer**.
2. Double-click the **Dial-Up Networking** folder.
3. Double-click **Make New Connection** (or **Add New Connection**, Win98).
4. Follow the onscreen instructions to configure your connection.

*Windows NT:*

1. Double-click **My Computer**.
2. Double-click **Dial-Up Networking**.

3. When the **Dial-Up Networking** dialog box opens, click **Install**.
4. Follow the onscreen instructions to configure your connection.

### **8.2.8 SET DIAL-UP TYPE (NT SERVER CONNECTION)**

*Windows 95/98:*

1. Right-click the newly created connection icon, then click **Properties**; the My Connection dialog box opens.
2. On the General tab, click **Server Type**; the Server Types dialog box opens. Select **PPP: Windows 95, Windows NT 3.5, Internet**.
3. Click (to check or enable) only the following items: **Log on to network**, **Enable software compression**, and **TCP/IP**. [Note: do not disturb any other items that are already checked.]

### **8.2.9 DIAL INTO YOUR NETWORK (NT SERVER CONNECTION)**

*Windows 95/98:*

1. You are ready to dial into your network.
2. Double-click the new connection icon; the Connect To dialog box opens.
3. Enter the user name (if necessary) and password configured for you on the Router.

## **NOTE**

**If your particular situation permits, click (to check) Save password.**

4. Click **Connect**.
5. After connecting to the Router, you can access the same services and resources as if you were connected to the network locally.

## **8.3 Accessing a Novell Server**

Novell NetWare® products are used on up to 70 percent of PC-based local area networks (LANs). Perform the following procedures when you need to connect your PC workstation to a remote Novell Server.

### 8.3.1 ADDING THE DIAL-UP ADAPTER (NOVELL SERVER CONNECTION)

*Windows 95/98:*

1. Click **Start, Settings, Control Panel**.
2. Double-click the Network icon to open the Network dialog box.
3. Click **Add**. The Select Network Component Type dialog box opens.
4. Select **Adapter**, then click **Add**. The Select Network adapters dialog box opens.
5. In the Manufacturers box, select **Microsoft**. In the Network Adapters box select **Dial-Up Adapter**.
6. Click **OK** (twice) to return to, and then close, the Network dialog box.

*Windows NT:*

Dial-up Networking adds PPP and SLIP protocol support, enabling your workstation to gain access to a remote computer or network, even if your computer is not on a network.

1. Double-click **My Computer**, then double-click **Dial-Up Networking**. The following screen is displayed:
2. Click **Install**, then follow the onscreen instructions to configure your connection.

### 8.3.2 ADDING IPX/SPX (NOVELL SERVER CONNECTION)

*Windows 95/98:*

1. In the Network dialog box, Configuration tab, click **Add**. The Select Network Component Type dialog box opens.
2. Select **Protocol** and click **Add**. The Select Network Protocol dialog box opens.
3. In the Manufacturers box, select **Microsoft**. In the Network Protocols box, select **IPX/SPX-compatible Protocol**.
4. Click **OK** (twice) to return to, and then close, the Network dialog box.



*Windows NT:*

## **NOTE**

NWLink IPX/SPX Compatible Transport is probably already installed, along with NWLink NetBIOS and TCP/IP Protocol; however, if NWLink IPX/SPX Compatible Transport does not appear on the Protocols tab of the Network dialog box, perform the following steps:

1. In the Network dialog box, Protocol tab, click **Add**. The Select Network Protocol dialog box opens.
2. Select **NWLink IPX/SPX Compatible Transport**, then click **OK** to return to the Network dialog box.
3. Click **Close** to close the Network dialog box and return to the desktop.

### **8.3.3 ADDING CLIENT FOR NETWARE NETWORKS (NOVELL SERVER CONNECTION)**

*Windows 95/98:*

1. In the Network dialog box, Configuration tab, click **Add**.
2. Select **Network Client** and click **Add**.
3. The Select Network Client dialog box opens. In the Manufacturer's box, select **Microsoft**. In the Network Clients box, select **Client for NetWare Networks**.
4. Click **OK** to add this Client and return to the Network dialog box.

### **8.3.4 SET-UP PROPERTIES OF COMPONENTS (NOVELL SERVER CONNECTION)**

#### ***Network Client***

*Windows 95/98:*

1. In the Network dialog box, Configuration tab, select **Client for Microsoft Networks**.
2. Click **Properties**. The Client for Microsoft Networks Properties dialog box opens.
3. On the General tab, select **Log on to Windows NT domain**.
4. Click the **Windows NT domain** field, then enter the name of your Windows NT domain, as provided by your Network Administrator.

5. Click **OK** to return to the Network dialog box.
6. In the Network dialog box, Configuration tab, select **Client for NetWare Networks**.
7. Click **Properties**.
8. On the General tab, in the Preferred server field, enter the name of your Novell Server Domain. If necessary, select the **First Network Drive**, then ensure that Enable logon script processing is checked (enabled). It's the default.
9. Click **OK** to return to the Network dialog box.

### 8.3.5 SET YOUR PRIMARY NETWORK LOGON

Windows 95/98:

1. In the Network dialog box, Configuration tab, select **Client for NetWare Networks** as the Primary Network Logon.
2. Click **OK**. You are returned to the desktop.

### 8.3.6 SET YOUR ACCESS CONTROL (NOVELL SERVER CONNECTION)

Windows 95/98:

1. In the Network dialog box, select the **Access Control** tab.
2. In the **Control Access to shared resources using** box, select **Share-Level Access Control**.

## NOTE

**You must restart your system for the new settings to take effect.**

### 8.3.7 MAKE YOUR NEW CONNECTION (NOVELL SERVER CONNECTION)

Windows 95/98:

1. Double-click **My Computer**.
2. Double-click the **Dial-Up Networking** folder.
3. Double-click **Make New Connection** (or **Add New Connection, Win98**).
4. Follow the onscreen instructions to configure your connection.

*Windows NT:*

1. Double-click **My Computer**.
2. Double-click **Dial-Up Networking**.
3. When the Dial-Up Networking dialog box opens, click **Install**.
4. Follow the onscreen instructions to configure your connection.

### **8.3.8 SET DIAL-UP TYPE (NOVELL SERVER CONNECTION)**

*Windows 95/98:*

1. Right-click the newly created connection icon, then click **Properties**; the My Connection dialog box opens.
2. On the General tab, click **Server Type**; the Server Types dialog box opens. Select **PPP: Windows 95, Windows NT 3.5, Internet**.
3. Click (to check or enable) only the following items: **Log on to network**, **Enable software compression**, and **TCP/IP**. [Note: do not disturb any other items that are already checked.]

### **8.3.9 DIAL INTO YOUR NETWORK (NOVELL SERVER CONNECTION)**

*Windows 95/98:*

1. You are ready to dial into your network.
2. Double-click the new connection icon; the Connect To dialog box opens.
3. Enter the user name (if necessary) and password configured for you on the Router.

## **NOTE**

**If your particular situation permits, click (to check) Save password.**

4. Click **Connect**.
5. After connecting to the Router, you can access the same services and resources as if you were connected to the network locally.

## 8.4 Accessing a Windows NT Server and a Novell NetWare Server

### NOTE

Before configuring your remote site, make sure that **TCP/IP** has been installed on your NT Server.

Perform the following procedures if your PC workstation needs to access both a Windows NT Server and a Novel NetWare Server.

#### 8.4.1 ADDING THE DIAL-UP ADAPTER (NOVELL/NT SERVER CONNECTION)

*Windows 95/98/NT:*

1. Click **Start, Settings, Control Panel**.
2. Double-click the **Network** icon to open the Network dialog box.
3. Click **Add**; the Select Network Component Type dialog box opens.
4. Select **Adapter**, then click **Add**. The Select Network adapters dialog box opens.
5. Win95/98 only: In the Manufacturers box, select **Microsoft**. In the Network Adapters box, select **Dial-Up Adapter**.

[Note: In Windows NT workstations, there is no Manufacturers box.]

6. Click **OK** (twice) to return to, and then close, the Network dialog box.

#### 8.4.2 ADDING TCP/IP (NOVELL/NT SERVER CONNECTION)

*Windows 95/98/NT:*

1. In the Network dialog box, Configuration tab, click **Add**.
2. Select **Protocol** and click **Add**.
3. The Select Network Protocol dialog box is displayed. In the Manufacturers box [Win95 only], select **Microsoft**. In the Network Protocols box, select **TCP/IP [Win95/98]** or **TCP/IP Protocol [WinNT only]**.

[Note: Windows NT workstation has no Manufacturers box.]

4. Click **OK** (twice) to return to, and then close, the Network dialog box.

**8.4.3 ADDING CLIENT FOR MICROSOFT NETWORKS (NOVELL/NT SERVER CONNECTION)**

*Windows 95/98:*

1. In the Network dialog box, Configuration tab, click **Add**.
2. Select **Network Client** and click **Add**.
3. The Select Network Client dialog box displays. In the Manufacturers option box, select **Microsoft**. In the Network Clients box, select **Client for Microsoft Networks**.
4. Click **OK** to add this Client and return to the Network dialog box.

**8.4.4 ADDING FILE AND PRINT SHARING FOR MICROSOFT NETWORKS (NOVELL/NT SERVER CONNECTION)**

*Windows 95/98:*

1. In the Network dialog box, Configuration tab, click **Add**.
2. Select **Services** and click **Add**.
3. The Select Network Service dialog box displays. In the Manufacturers box, select **Microsoft**. Select **File and Printer sharing for Microsoft Networks**.  
  
[Note: Windows 98 has no Manufacturers box.]
4. Click **OK** (twice) to return to, and then close, the Network dialog box.

**8.4.5 ADDING IPX/SPX (NOVELL/NT SERVER CONNECTION)**

*Windows 95/98:*

1. In the Network dialog box, Configuration tab, click **Add**. The Select Network Component Type dialog box opens.
2. Select **Protocol** and click **Add**. The Select Network Protocol dialog box opens.
3. In the Manufacturers box, select **Microsoft**. In the Network Protocols box, select **IPX/SPX-compatible Protocol**.
4. Click **OK** (twice) to return to, and then close, the Network dialog box.

*Windows NT:*

### NOTE

NWLink IPX/SPX Compatible Transport is probably already installed, along with NWLink NetBIOS and TCP/IP Protocol; however, if NWLink IPX/SPX Compatible Transport does not appear on the Protocols tab of the Network dialog box, perform the following steps:

1. In the Network dialog box, Protocol tab, click **Add**. The Select Network Protocol dialog box opens.
2. Select **NWLink IPX/SPX Compatible Transport**, then click **OK** to return to the Network dialog box.
3. Click **Close** to close the Network dialog box and return to the desktop.

#### 8.4.6 ADDING CLIENT FOR NETWARE NETWORKS (NOVELL/NT SERVER CONNECTION)

*Windows 95/98:*

1. In the Network dialog box, Configuration tab, click **Add**.
2. Select **Network Client** and click **Add**.
3. The Select Network Client dialog box displays. In the Manufacturers box, select **Microsoft**. In the Network Clients box, select **Client for NetWare Networks**.
4. Click **OK** to add this Client and return to the Network dialog box.

#### 8.4.7 SET YOUR PRIMARY NETWORK LOGON (NOVELL/NT SERVER CONNECTION)

*Windows 95/98:*

1. In the Primary Network Logon box on Configuration tab of the Network dialog box, select (the previously installed) **Client for Microsoft Networks**.
2. Click **OK** to close the Network dialog box.

#### 8.4.8 SET-UP PROPERTIES OF COMPONENTS (NOVELL/NT SERVER CONNECTION)

##### *Dial-up Adapter*

*Windows 95/98:*

1. In the Network dialog box, Configuration tab, select the **TCP/IP - Dial-Up Adapter**.

2. Click **Properties**. The TCP/IP Properties dialog box opens with the IP Address tab selected.
3. Make sure that **Obtain an IP Address Automatically** is selected. (It's the default.)
4. Click **OK** to close the TCP/IP Properties dialog box.

## *Network Client*

### *Windows 95/98:*

1. In the Network dialog box, Configuration tab, select **Client for Microsoft Networks**.
2. Click **Properties**. The Client for Microsoft Networks Properties dialog box opens.
3. On the General tab, select **Log on to Windows NT domain**.
4. Click the **Windows NT domain** field, then enter the name of your Windows NT domain, as provided by your Network Administrator.
5. Click **OK** to return to the Network dialog box.
6. In the Network dialog box, Configuration tab, select **Client for NetWare Networks**.
7. Click **Properties**.
8. On the General tab, in the Preferred server field, enter the name of your Novell Server Domain. Select the **First Network Drive** and **Enable Logon Script processing**.
9. Click **OK**.

## *Network Protocol*

### *Windows 95/98:*

1. In the Network dialog box, Configuration tab, select **IPX/SPX Compatible Protocol**.
2. Click **Properties**.

3. Disable **Client for Microsoft Networks** and **File and Printer Sharing for Microsoft Networks**. This will ensure that when you log into your NT server, Windows will use the TCP/IP protocol. Next, you must enable **Client for Microsoft Networks**.

### *Set Your Identification*

*Windows 95/98:*

1. In the Network dialog box, select the **Identification** tab.
2. In the Workgroup field, enter the name of your NT domain or the name of your workgroup as provided by your Network Administrator.
3. Enter a name and description for your computer in the fields provided.
4. Click **OK**.

### *Set Your Access Control*

*Windows 95/98:*

1. In the Network dialog box, select the **Access Control** tab.
2. In the Control Access to Shared resources using group, select **Share-level access control**.
3. Click **OK** (twice) to return to, and then close, the Network dialog box.

## NOTE

**You must restart your system for the new settings to take effect.**

Once your machine has restarted, you may continue the configuration process.

### **8.4.9 MAKE YOUR NEW CONNECTION (NT/NOVELL SERVER CONNECTION)**

*Windows 95/98:*

1. Double-click **My Computer**.
2. Double-click the **Dial-Up Networking** folder.
3. Double-click **Make New Connection** (or **Add New Connection, Win98**).
4. Follow the onscreen instructions to configure your connection.



*Windows NT:*

1. Double-click **My Computer**.
2. Double-click **Dial-Up Networking**.
3. When the Dial-Up Networking dialog box opens, click **Install**.
4. Follow the onscreen instructions to configure your connection.

#### **8.4.10 SET DIAL-UP TYPE (NT/NOVELL SERVER CONNECTION)**

*Windows 95/98:*

1. Right-click the newly created connection icon, then click **Properties**; the My Connection dialog box opens.
2. On the General tab, click **Server Type**; the Server Types dialog box opens. Select **PPP: Windows 95, Windows NT 3.5, Internet**.
3. Click (to check or enable) only the following items: **Log on to network**, **Enable software compression**, and **TCP/IP**. [Note: do not disturb any other items that are already checked.]

#### **8.4.11 DIAL INTO YOUR NETWORK (NT/NOVELL SERVER CONNECTION)**

*Windows 95/98:*

1. You are ready to dial into your network.
2. Double-click the new connection icon; the Connect To dialog box opens.
3. Enter the user name (if necessary) and password configured for you on the Router.

### **NOTE**

**If your particular situation permits, click (to check) Save password.**

4. Click **Connect**.
5. After connecting to the Router, you can access the same services and resources as if you were connected to the network locally.

## 8.5 Accessing a Unix Server

Perform the following procedures to prepare your PC workstation to access a remote Unix Server.

### 8.5.1 ADDING THE DIAL-UP ADAPTER (UNIX SERVER CONNECTION)

*Windows 95/98/NT:*

1. Click **Start | Settings | Control Panel**.
2. Double-click the Network icon to open the Network dialog box.
3. Click **Add**; the Select Network Component Type dialog box opens.
4. Select **Adapter**, then click **Add**. The Select Network adapters dialog box opens.
5. In the Manufacturers box, select **Microsoft**. In the Network Adapters box select **Dial-Up Adapter**.
6. Click **OK** (twice) to return to, and then close, the Network dialog box.

*Windows NT:*

Dial-up Networking adds PPP and SLIP protocol support, enabling your workstation to gain access to a remote computer or network, even if your computer is not on a network.

1. Double-click **My Computer**, then double-click **Dial-Up Networking**. The following screen is displayed:
2. Click **Install**, then follow the onscreen instructions to configure your connection.

### 8.5.2 ADDING TCP/IP (UNIX SERVER CONNECTION)

*Windows 95/98/NT:*

1. In the Network dialog box, Configuration tab, click **Add**.
2. Select Protocol and click **Add**.
3. The Select Network Protocol dialog box is displayed. In the Manufacturers box [Win95 only], select **Microsoft**. In the Network Protocols box, select **TCP/IP [Win95/98]** or **TCP/IP Protocol [WinNT only]**.

[Note: Windows NT workstation has no Manufacturers box.]

4. Click **OK** (twice) to return to, and then close, the Network dialog box.

### 8.5.3 SET-UP PROPERTIES OF COMPONENTS (UNIX SERVER CONNECTION)

#### *Dial-Up Adapter*

*Windows 95/98:*

1. In the Network dialog box, Configuration tab, select the **TCP/IP - Dial-Up Adapter**.
2. Click **Properties**. The TCP/IP Properties dialog box opens with the IP Address tab selected.
3. Make sure that **Obtain an IP Address Automatically** is selected. (It's the default.)
4. Click **OK** to close the TCP/IP Properties dialog box.

### NOTE

**You must restart your machines to enable the new settings.**

### 8.5.4 MAKE YOUR NEW CONNECTION (UNIX SERVER CONNECTION)

*Windows 95/98:*

1. Double-click **My Computer**.
2. Double-click the **Dial-Up Networking** folder.
3. Double-click **Make New Connection** (or **Add New Connection, Win98**).
4. Follow the onscreen instructions to configure your connection.

*Windows NT:*

1. Double-click **My Computer**.
2. Double-click **Dial-Up Networking**.
3. When the Dial-Up Networking dialog box opens, click **Install**.
4. Follow the onscreen instructions to configure your connection.

**8.5.5 SET DIAL-UP TYPE (UNIX SERVER CONNECTION)***Windows 95/98:*

1. Right-click the newly created connection icon, then click **Properties**; the My Connection dialog box opens.
2. On the General tab, click **Server Type**; the Server Types dialog box opens. Select **PPP: Windows 95, Windows NT 3.5, Internet**.
3. Click (to check or enable) only the following items: **Log on to network**, **Enable software compression**, and **TCP/IP**. [Note: do not disturb any other items that are already checked.]

**8.5.6 DIAL INTO YOUR NETWORK (UNIX SERVER CONNECTION)***Windows 95/98:*

1. You are ready to dial into your network.
2. Double-click the new connection icon; the Connect To dialog box opens.
3. Enter the user name (if necessary) and password configured for you on the Router.

**NOTE**

If your particular situation permits, click the **Save password box**.

4. Click **Connect**.
5. After connecting to the Router, you can access the same services and resources as if you were connected to the network locally.

**8.6 Make New Connection (Windows 2000 Only)**

Perform the following procedures to prepare your Windows 2000 PC workstation to access any of the remote Servers and enable applications such as e-mail, Web browsing, file sharing, and printing.

1. Double-click **My Computer**.
2. Double-click the **Network and Dial-up Connections** folder.
3. Double-click **Make New Connection**.

4. Click **Next>>**, then follow the onscreen instructions to configure your connection.

## 9. LAN-to-LAN Settings

The majority of settings for LAN-to-LAN Routing are set up through Broadband Wizard or Broadband Manager when IP routing (NAT disabled) is configured. This section provides an overview of LAN-to-LAN Routing and shows you some of the benefits and limitations of LAN-to-LAN Routing.

### 9.1 Setting Up a Windows Machine to Share Files

If you would like to share files over your network but don't want to install a Windows NT server, you can enable the file sharing feature of Windows. To set up file sharing:

#### NOTE

Each computer that you wish to share files among must be within the same workgroup. Use the Identification tab of the Network Dialog box to define a workgroup name.

1. Select **Start, Settings, Control Panel**.
2. Click **Network**.
3. Click **File and Printer Sharing**.
4. To enable file sharing, select **I want to be able to give others access to my files**.
5. If you haven't already done so, ensure that this computer has a fixed IP address on your local network. Refer to **Chapter 8** for information on configuring a fixed IP address.
6. After configuring and activating the fixed IP address (using My Computer or Windows Explorer), right-click the file or drive on the computer that you would like to share.
7. Select **Sharing**.
8. Enable sharing by selecting **Shared As**. Enter the name by which you would like this file or drive to be known on your network.
9. You may now share the file(s) on this computer.

## 9.2 Using the Find Computer Command

If your clients are in different subnets or separated by a router, you will not be able to use the Find Computer function within Windows by selecting **Start | Find | Computer**.

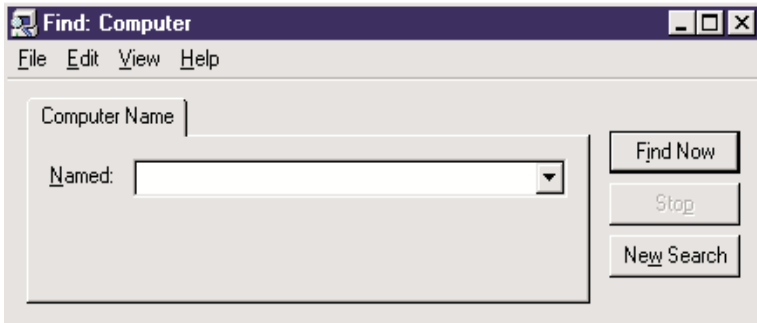

**Figure 9-1. Find Computer dialog box.**

In the Find Computer dialog box, type the IP address of the computer you would like to find in the Named field. If you choose a computer on a remote network, the network device will attempt to establish a dial-up connection to the remote LAN based on settings entered in Broadband Manager. If you have entered the computer's IP address and host name into your LMHosts file, you may enter the computer's host name, rather than the IP address in the Named field (refer to **Section 9.3**).

### NOTE

If the computer you are attempting to access is on a remote LAN, you may need to press Find Now more than once while you wait for your network device to establish a dial-up connection to your remote LAN.

## 9.3 Using LMHosts

### IMPORTANT

Each computer on the LAN must have a copy of this lookup table. Once you have mapped the necessary computer or host names and IP addresses in the LMHosts file, copy this file to the appropriate folder on each computer on the LAN. This file is located in your x:\Windows folder, where x: is the drive letter associated with the location of your windows operating system. Use Windows Explorer, Tools | Find | Files or Folders option to search for LMHosts.

The LMHosts file can be edited using a text editor such as Notepad. At the end of the file, enter the IP address, followed by a space, then the host or computer name. Add all necessary IP addresses and computer names to the LMHosts file and save the file.

Once the LMHost file has been copied to each computer, the user will be able to enter the name of the computer they want to access on the LAN without having to remember the IP address.

When using Find Computer, you may enter either an IP address or the computer's host name if you have entered the name and IP address in your LMHosts' lookup table.

### NOTE

**Since the computers you'll add to the LMHosts file are generally servers, only computers with fixed IP addresses should be added to this file.**



# 10. Troubleshooting

This chapter provides a list of common problems encountered while installing, configuring, or administering the Router. If you are unable to resolve your problem, call Black Box Technical Support at 724-746-5500.

## 10.1 Problems/Solutions

**Problem:** My computer can't detect my Router on the LAN when I start one of the Broadband Utilities (that is, Device Not Found).

**Solution #1:** Try pressing the **Refresh Device List** button.

**Solution #2:** Unplug your network device and plug it back in, then press **Refresh Device List**.

**Solution #3:** Make sure your computer has TCP/IP properly configured. You can check this by trying to "ping" the computer you are using. If you can successfully ping the computer from itself, the computer has TCP/IP correctly installed. Once you determine that you are able to ping the computer, try to ping another computer in the same segment of your network. If this ping is successful, your computer is properly connected to the network.

**Solution #4:** Remove the TCP/IP Dial-up Adapter from your computer. For instructions, see the Problem listed below.

**Solution #5:** Make sure your network device is properly connected to your Ethernet hub by pressing **Refresh Device List** in either Broadband Manager or Broadband Monitor. If your Router is correctly connected, the WAN indicator light on your Router will flash. If no flash occurs, it is not properly connected to the network. Reconnect your network device to the hub and try again. If there is still no flash, it is possible the Ethernet cable or hub has a problem.

**Problem:** Other computers can connect to the network device, but my computer can't.

Whenever I click on Internet Explorer or Netscape, I see the Windows Dial-up utility popping up on my screen asking for my phone number and password to dial-up my ISP.

**Solution #1:** Remove the TCP/IP dial-up adapter from all computers that will be using your Router to access the Internet. TCP/IP dial-up adapter is not needed to use the Router to connect to the Internet.

1. To remove the Dial-up Adapter, click **Start | Settings | Control Panel**.
2. Double-click the **Network** icon.
3. Click the **Dial-up Adapter** and press **Remove**. Restart the computer and try again.

**Solution #2:** Make sure you have a correct IP address. From a DOS window in Windows 95/98, type `wiipcfg`. From Windows NT, type `ipconfig`. If the address field is listed as 0.0.0.0, the computer does not have an IP address and you must ensure the automatic DHCP configuration has been correctly set up for this computer.

**Solution #3:** Make sure that the Web browser is properly configured to connect to the Internet via the LAN.

**Problem:** The Router is connected to the Cable/DSL, but has problems accessing the Internet.

**Solution #1:** Make sure the workstation has TCP/IP properly configured.

**Solution #2:** Attempt to ping the IP address of the Router.

**Solution #3:** Use Broadband Monitor to see if the WAN Ethernet port has successfully acquired a dynamic IP address from the ISP, or if the static IP address is valid.

**Solution #4:** Use `Winipcfg` (Windows 95/98) or `ipconfig` (Windows NT/ 2000) to check to see if the computer's IP settings are correct.

**Solution #5:** Make sure the DNS settings are correct.

**Solution #6:** Make sure the Gateway IP address is the device's LAN Ethernet IP address (Server IP address).

**Solution #7:** Make sure the IP address netmask is correct.

**Problem:** When I install the Broadband Utilities, I get the error message “missed export file oleaut32.dll”

**Solution:** If you are using Windows 95/98, your computer has an old version of oleaut32.dll.

- Download the newest version of oleaut32.dll from the Microsoft web site (<http://www.microsoft.com>).
- Create a backup of the file c:\windows\system\oleaut32.dll.
- Copy the new file to c:\windows\system\oleaut32.dll.
- After you have successfully copied the file, reinstall the Broadband Utilities.
- If you have problems with the new oleaut.dll file, use the backup file.

**Problem:** I configured my Router but I can't get it to communicate with my modem.

**Solution:**

- Check your initialization string. If you are using an ISDN TA and your ISDN TA was not listed as a choice in Setup Wizard, refer to the ISDN TA User Guide for the appropriate initialization string.
- After ensuring that the initialization string is correct, use the on-line help in Broadband Monitor.

**Problem:** My Router dials a connection, but it doesn't seem to communicate with the ISP.

**Solution:**

- Verify that your baud rate is not set too high for your modem or ISDN TA. The maximum baud rate that your modem or ISDN claims it can achieve may not be attainable due to poor line or connection quality. Use Broadband Manager's Modem settings menu to correct set the baud rate to a lower rate and retry the connection.

- If after lowering the baud rate, you can't establish a connection, use the Broadband Monitor's on-line help. If your connection still doesn't work, contact your ISP.

**Problem:** Sometimes when I try to use the Internet or get my mail, the application can't connect to the Internet immediately.

**Solution:**

- The most common reason for this is not due to a problem or error. If you are the first person to make a connection to the Internet through the Router, there will be a delay when the Dial-On-Demand function automatically makes the connection and logs on to your ISP. Subsequent users will be able to use the connection you've established without a delay.
- If the scenario described above does not fit your situation, use Broadband Monitor to view all events that are taking place between the modem and your ISP as you attempt to make a connection (for example, a busy signal).

**Problem:** After installing my Router, my modem connection seems to be slower.

**Solution:**

- The Router should have no effect on the modem speed. However, if more than one client is using the same modem through the Router, the speed will be reduced.
- Run Broadband Monitor to view the number of concurrent client connections to your ISP.

**Problem:** While the Serial async port is in use, my Router keeps dialing a connection to the Internet, but no one is using the Internet.

- The Router will only dial the connection if there is a request from one of the computers on the LAN for an IP address on the Internet. Keep in mind that certain applications can be configured to request information from the Internet. For example, Microsoft Outlook can be set up to "check for new mail every  $x$  minutes". If this feature is enabled, Outlook will send a request for your Internet POP3 server, which will cause your Router to dial-up your ISP. To

determine which computer on your network is processing a request for an Internet connection, use the Broadband Monitor. The event messages will provide information about which computer is causing the Router to dial and which service (port#) the computer is requesting.

**Problem:** The “Please set the Device IP” screen displays when configuring the Router.

**Solution:** This system detects that the Router’s LAN Ethernet IP address is not in the same subnet as the PCs. Use Broadband Manager to set the Router’s IP address to the same network as your PC’s.

**Problem:** A message indicates that the IP address you have inputted is either not valid on your network or is in conflict with another IP address.

**Solution:** The manager has detected that the IP address of the Router you are configuring is in conflict with another device. Power off the conflicting device and configure the Router using a different Ethernet LAN IP address.

## 10.2 Calling Black Box

If you determine that your Router is malfunctioning, do not attempt to alter or repair the unit. It contains no user-serviceable parts. Contact Black Box at 724-746-5500.

Before you do, make a record of the history of the problem. We will be able to provide more efficient and accurate assistance if you have a complete description, including:

- the nature and duration of the problem.
- when the problem occurs.
- the components involved in the problem.
- any particular application that, when used, appears to create the problem or make it worse.

### 10.3 Shipping and Packaging

If you need to transport or ship your Router:

- Package it carefully. We recommend that you use the original container.
- If you are shipping the Router for repair, make sure you include everything that came in the original package. Before you ship, contact Black Box to get a Return Authorization (RA) number.

# Appendix A. Tools for Your Router

## A.1 Broadband Monitor

If you are having problems, the Broadband Monitor can be a valuable tool to assist in troubleshooting. Additional troubleshooting information is available through the on-line help screens.

## A.2 PING

Ping is an acronym for Packet Internet Groper. The PING utility is used as a diagnostic tool to determine if a communication path exists between two devices on the network. The utility sends a packet to the specified address and then waits for a reply. PING is used primarily to troubleshoot Internet connections, but it can be used to test the connection between any devices using the TCP/IP protocol.

## A.3 WINIPCFG and IPCONFIG

There are two tools which are helpful in finding a computer's IP configuration: MAC address and default gateway.

### WINIPCFG (FOR WINDOWS 95/98)

1. Select **Start | Run** and type `winipcfg`.
2. The IP address, default gateway (the Router's IP address), and the MAC (adapter address) display.

### IPCONFIG (FOR WINDOW NT/2000)

1. From a DOS Prompt, type `IPCONFIG` and press **Enter**.
2. The IP address, default gateway (the Router IP address), and the MAC (adapter address) display.

## A.4 TRACERT

TRACERT is an extensive PING utility that allows you to trace the route of an IP address. The utility reports the number of router hops, the time for each hop, and any failed attempts to cross a hop. The information provided by this utility assists you to locate the specific site of a failed PING. You can run TRACERT at the DOS prompt (for example, `c:\tracert www.yahoo.com`). The utility will provide information about the route and number of hops required to reach the destination IP address associated with the network address or URL.



# Appendix B. Cabling Diagrams

## B.1 WAN/LAN Cables

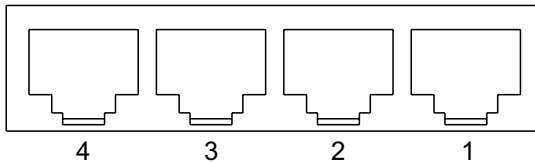
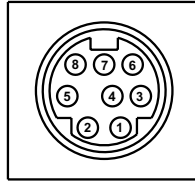

**Figure B-1. WAN/LAN connectors.**

**Table B-1. Pinning.**

Pin	Circuit Signal Name
1	TD+ Data Transmit Positive
2	TD- Data Transmit Negative
3	RD+ Data Receive Positive
6	RD- Data Receive Negative

B.2 Serial Cable



Serial

**Figure B-2. Serial connector.**

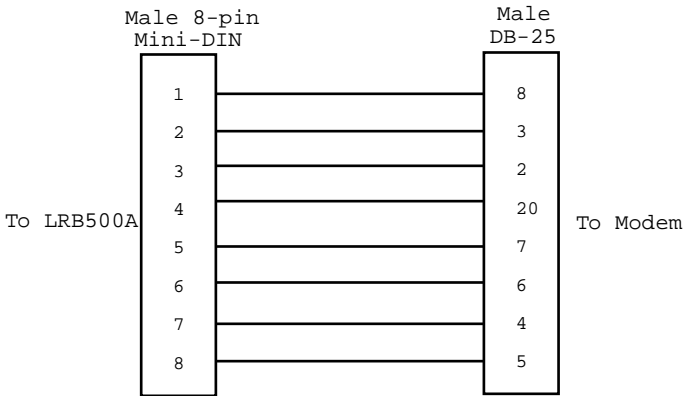

**Figure B-3. Pinning.**

## Appendix C. Glossary

### B

**Baud rate:** Baud rate refers to the number of bits per second (bps) that are transmitted between your network device and modem or ISDN TA.

### D

**DHCP (Dynamic Host Configuration Protocol):** A protocol that was made to lessen the administrative burden of having to manually configure TCP/IP Hosts on a network. DHCP makes it possible for every computer on a network to extract its IP information from a DHCP server instead of having to be manually configured on each network computer. The DHCP server built into your Router allows every computer on your network to automatically extract IP information from the Router.

#### *Why is it called Dynamic?*

Each time a network client turns on their computer, your Router DHCP server will automatically give them an IP address from the IP address pool configured in the DHCP Configuration dialog box in Broadband Manager. It's called Dynamic because the address that is issued could be different each time a computer connects to the network.

**DNS (Domain Name System):** A DNS Server can be thought of as the computer at your ISP whose job is to take all the URLs that you type into your web browser and translate them to their corresponding IP address. To use this the DNS translator, you need to know the IP address of your ISP's DNS Server.

### E

**Ethernet:** A LAN (Local Area Network) protocol developed by Xerox® and DEC™. It is a very commonly used type of LAN.

## F

**Firewall:** A system designed to prevent unauthorized access to or from a private network. Firewalls are typically installed to give users access to the Internet while protecting their internal information. Your Router uses a firewall technology known as NAT (see NAT). Each message entering or leaving the intranet passes through the firewall. The firewall examines each message and blocks those that do not meet the specified security criteria.

**Firmware:** Software that has been permanently or semi-permanently written to the Router's memory. Your Router supports flash ROM, which means you can upgrade the firmware in your network device very easily by downloading a copy of the new firmware from the Black Box Web site and using the Broadband Manager Upgrade Firmware function.

**FTP (File Transfer Protocol):** A protocol which allows a user on one host to access (and transfer files to and from) another host over a network.

## I

**Intranet:** An Intranet is the use of Internet technologies within a company. Intranets are private networks that exist only within organizations, while the Internet is a global network open to all.

**IP (Internet Protocol):** The Internet Protocol is the network layer for the TCP/IP Protocol Suite. It is a connectionless, best-effort packet switching protocol.

**IP Addresses:** A computer on the Internet is identified by an IP Address. A computer's IP address is like a telephone number. It identifies one address (or in this case one computing device). Every computer or device on the network must have a different IP address.

An IP address consists of four groups of numbers (called octets), which are separated by periods. For example, 213 .0.0.1 is an IP address. An IP address consists of a network portion and a host portion. The network portion identifies the subnet that the computer belongs to. The host portion identifies the particular computer or node on that network.

IP addresses can either be dynamic (temporary) or static (permanent or fixed). A dynamic IP address is a temporary IP address that is assigned to you by a server (usually a DHCP server) when the computer is powered on. A static IP address is a permanent IP address that is set up on each individual computer. When your Router dials your ISP, your ISP can give it a fixed or dynamic IP address. Likewise when you power on your computer, the Router can give your computer a dynamic or fixed IP address.

**ISDN TA:** (Integrated Services Digital Network Terminal Adapter) ISDN is a high-speed digital telephone connection involving the digitization of the telephone network using existing wiring. An ISDN Terminal Adapter can be thought of as an ISDN Modem.

**ISP (Internet Service Provider):** An organization that provides Internet services. An ISP is the company that provides the connection from your computer to the Internet. An ISP can offer a range of services, such as dial-up accounts, e-mail, web hosting, or News.

## L

**LAN (Local Area Network):** A data network intended to serve an area of only a few square kilometers or less. This often means a small, private network in companies.

## M

**MAC address:** The hardware address of a device connected to a shared media. To find out the MAC address of your computer, see **Chapter 10**.

**ML-PPP (Also called MP or MPPP):** Stands for Multilink Point to Point Protocol and is an advancement of the PPP protocol that allows for the bridging or bundling of two ISDN or analog channels for faster connections.

## N

**NAT Technology:** NAT is short for Network Address Translation. NAT is an Internet standard that enables a local-area network to use one set of IP addresses for internal traffic and a second set of IP addresses for external traffic. The Router provides the necessary IP address translations. NAT is sometimes referred to as “IP Address Masquerading”. This technology provides a type of firewall by hiding the internal IP addresses.

### *How does it work?*

Every IP address on the Internet is a registered or legal IP address. Therefore, no two IP addresses on the Internet are the same. For you to use your network device to access the Internet, you need a registered IP address from your ISP (Internet Service Provider). Using a registered IP address on your Intranet or LAN is not necessary. When clients on your network start surfing the Internet, your Broadband will receive all the requests for information. The Router will dial-up your ISP and your ISP will give your Router a registered legal IP address. Your Router uses this IP address to request information saying “send all information

back to me at this IP address.” In essence, it appears as though all your clients requests are coming from that one IP address (hence the name “IP masquerading”). When all the information comes back through the Broadband, it sorts the data using an Address Translation Table and returns the data to the computer on your network that requested it.

If someone on the Internet tries to access your network, the firewall function of the Router stops the request. The device will not reverse-translate network addresses unless you have specifically allowed this feature using the Virtual Server function (IP Mapping).

**Network Address:** The network portion of an IP address. For a class A network, the network address is the first byte of the IP address. For a class B network, the network address is the first two bytes of the IP address. For a class C network, the network address is the first three bytes of the IP address. In each case, the remainder is the host address. In the Internet, assigned network addresses are globally unique.

## P

**Packet:** A packet is a piece of a message transmitted over a packet-switching network. A packet contains the destination address of the message as well as the data. In IP networks, packets are often called datagrams.

**Port Number:** The term “port” can mean the connector on your computer or it can be thought of as a server number. Every service that travels over phone lines and modems has a standard port number. For example, the World Wide Web service uses the standard port number, 80; the standard telnet port is 23.

Port numbers are controlled and assigned by the IANA (Internet Assigned Numbers Authority). Most computers have a table in their systems containing a list of ports that have been assigned to specific services. You can also find lists of standard port numbers on the World Wide Web.

**PPP (Point-to-Point Protocol):** PPP enables dial-up connections to the Internet and is the method that your network device connects to the Internet. PPP is more stable than the older SLIP protocol and provides error-checking features.

**Protocol:** A formal description of message formats and the rules two computers must follow to exchange those messages. You can think of protocols like languages. If two computers or devices aren't speaking the same language to each other, they won't be able to communicate.

## R

**Router:** A device which forwards traffic between networks. If you request information from a location on your network or the Internet, the router will route the request to the appropriate destination. The router's job is to listen for requests for IP addresses that are not part of your LAN. It routes them to the appropriate network, which may either be the Internet or another subnetwork on your LAN.

## S

**Server:** A provider of resources (e.g., file servers and name servers). For example, your Broadband provides Internet Access and can be thought of as an Internet Access Server.

**Subnet:** A portion of a network that shares a common address component. On TCP/IP networks, subnets are defined as all devices whose IP Addresses have the same prefix. For example, all devices with IP addresses that start with 213.0.0. would be part of the same subnet.

**SubnetMask/IPAddressMask:** A subnet mask is what'

s used to determine what subnet an IP address belongs to. Subnetting enables the network administrator to further divide the host part of the address into two or more subnets.

## T

**TCP/IP (Transmission Control Protocol/Internet Protocol):** A suite of communication protocols used to connect hosts on the Internet. Every computer that wants to communicate with another computer on the Internet must use the TCP/IP protocol to transmit and route data packets. The format of an IP address is a 32-bit numeric address written as four octets separated by periods. Each number can be zero to 255. Within an isolated network, you can assign IP addresses at random as long as each one is unique. However, connecting a private network to the Internet requires using registered IP addresses to avoid duplication.

The four groups of numbers (octets) are used to identify a particular network and host on that network. The InterNIC assigns Internet addresses as Class A, Class B, or Class C. Class A supports 16 million hosts on each of 127 networks. Class B supports 65,000 hosts on each of 16,000 networks. Class C supports 254 hosts on each of 2 million networks. Due to the large increase in access to the Internet, new classless schemes are gradually replacing the system based on classes.

## U

**UDP (User Datagram Protocol):** An Internet Standard transport layer protocol. It is a connectionless protocol that adds a level of reliability and multiplexing to IP.