



© Copyright 2005. Black Box Corporation. All rights reserved.

1000 Park Drive • Lawrence, PA 15055-1018 • 724-746-5500 • Fax 724-746-0746



Managed 24-Port 10/100/1000 Ethernet Switch with 2 SFP Dual Media

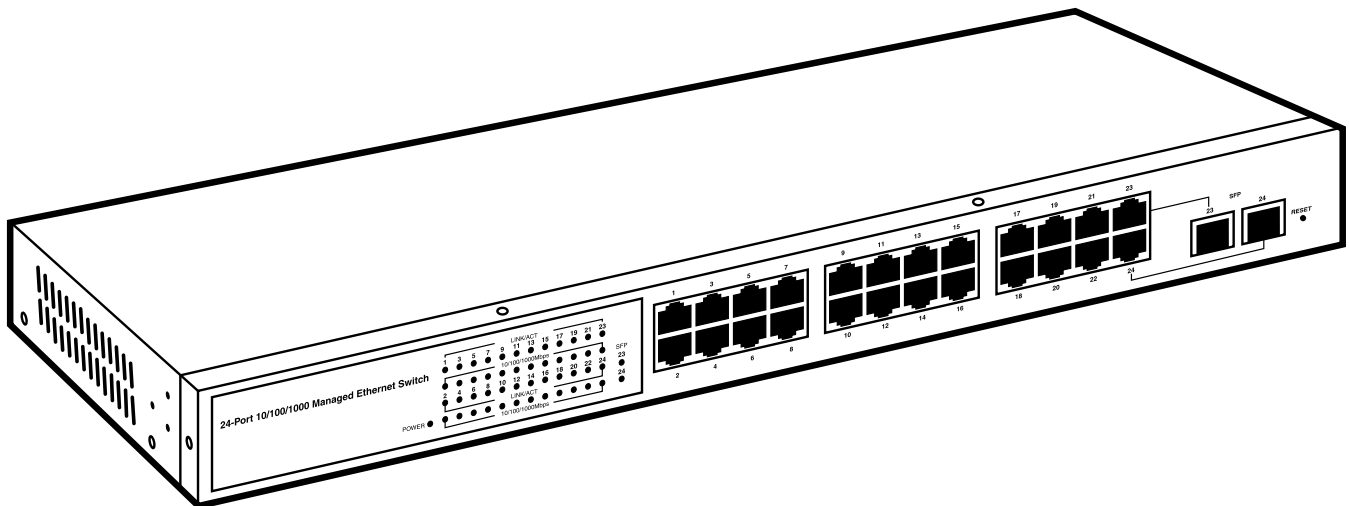

**CUSTOMER
SUPPORT
INFORMATION**

Order toll-free in the U.S.: Call **877-877-BBOX** (outside U.S. call **724-746-5500**)
FREE technical support 24 hours a day, 7 days a week: Call **724-746-5500** or fax **724-746-0746**
Mailing address: **Black Box Corporation**, 1000 Park Drive, Lawrence, PA 15055-1018
Web site: www.blackbox.com • E-mail: info@blackbox.com

**FEDERAL COMMUNICATIONS COMMISSION
AND
INDUSTRY CANADA
RADIO FREQUENCY INTERFERENCE STATEMENTS**

This equipment generates, uses, and can radiate radio-frequency energy, and if not installed and used properly, that is, in strict accordance with the manufacturer's instructions, may cause interference to radio communication. It has been tested and found to comply with the limits for a Class A computing device in accordance with the specifications in Subpart B of Part 15 of FCC rules, which are designed to provide reasonable protection against such interference when the equipment is operated in a commercial environment. Operation of this equipment in a residential area is likely to cause interference, in which case the user at his own expense will be required to take whatever measures may be necessary to correct the interference.

Changes or modifications not expressly approved by the party responsible for compliance could void the user's authority to operate the equipment.

This digital apparatus does not exceed the Class A limits for radio noise emission from digital apparatus set out in the Radio Interference Regulation of Industry Canada.

Le présent appareil numérique n'émet pas de bruits radioélectriques dépassant les limites applicables aux appareils numériques de la classe A prescrites dans le Règlement sur le brouillage radioélectrique publié par Industrie Canada.

INSTRUCCIONES DE SEGURIDAD (Normas Oficiales Mexicanas Electrical Safety Statement)

1. Todas las instrucciones de seguridad y operación deberán ser leídas antes de que el aparato eléctrico sea operado.
2. Las instrucciones de seguridad y operación deberán ser guardadas para referencia futura.
3. Todas las advertencias en el aparato eléctrico y en sus instrucciones de operación deben ser respetadas.
4. Todas las instrucciones de operación y uso deben ser seguidas.
5. El aparato eléctrico no deberá ser usado cerca del agua—por ejemplo, cerca de la tina de baño, lavabo, sótano mojado o cerca de una alberca, etc..
6. El aparato eléctrico debe ser usado únicamente con carritos o pedestales que sean recomendados por el fabricante.
7. El aparato eléctrico debe ser montado a la pared o al techo sólo como sea recomendado por el fabricante.
8. Servicio—El usuario no debe intentar dar servicio al equipo eléctrico más allá a lo descrito en las instrucciones de operación. Todo otro servicio deberá ser referido a personal de servicio calificado.
9. El aparato eléctrico debe ser situado de tal manera que su posición no interfiera su uso. La colocación del aparato eléctrico sobre una cama, sofá, alfombra o superficie similar puede bloquea la ventilación, no se debe colocar en libreros o gabinetes que impidan el flujo de aire por los orificios de ventilación.
10. El equipo eléctrico deber ser situado fuera del alcance de fuentes de calor como radiadores, registros de calor, estufas u otros aparatos (incluyendo amplificadores) que producen calor.
11. El aparato eléctrico deberá ser conectado a una fuente de poder sólo del tipo descrito en el instructivo de operación, o como se indique en el aparato.
12. Precaución debe ser tomada de tal manera que la tierra física y la polarización del equipo no sea eliminada.
13. Los cables de la fuente de poder deben ser guiados de tal manera que no sean pisados ni pellizcados por objetos colocados sobre o contra ellos, poniendo particular atención a los contactos y receptáculos donde salen del aparato.
14. El equipo eléctrico debe ser limpiado únicamente de acuerdo a las recomendaciones del fabricante.
15. En caso de existir, una antena externa deberá ser localizada lejos de las líneas de energía.
16. El cable de corriente deberá ser desconectado del cuando el equipo no sea usado por un largo periodo de tiempo.
17. Cuidado debe ser tomado de tal manera que objetos líquidos no sean derramados sobre la cubierta u orificios de ventilación.
18. Servicio por personal calificado deberá ser provisto cuando:
 - A: El cable de poder o el contacto ha sido dañado; u
 - B: Objetos han caído o líquido ha sido derramado dentro del aparato; o
 - C: El aparato ha sido expuesto a la lluvia; o
 - D: El aparato parece no operar normalmente o muestra un cambio en su desempeño; o
 - E: El aparato ha sido tirado o su cubierta ha sido dañada.

TRADEMARKS USED IN THIS MANUAL

DB2 and IBM are registered trademarks of International Business Machines Corporation.

Microsoft is either a registered trademark or a trademark of Microsoft Corporation in the United States and/or other countries.

Any other trademarks mentioned in this manual are acknowledged to be the property of the trademark owners.

NOTE

The Managed 24-Port 10/100/1000 Ethernet Switch with 2 SFP Dual Media is called the Giga Switch in the software screens and also in the screens shown in this manual. Both names refer to the LGB2003A switch.

Contents

Chapter	Page
1. Specifications	6
2. Overview	7
2.1 Introduction.....	7
2.2 Components	7
2.2.1 Front Panel	7
2.2.2 Rear Panel.....	8
2.3 What's Included.....	9
3. Installation	10
3.1 Hardware and Cable Installation	10
3.1.1 Installing the Optional Modules	10
3.1.2 Connecting the Cable	11
3.1.3 Powering On the Switch	11
3.1.4 Installing the Chassis on a Desktop	11
3.1.5 Installing the Chassis into a 19-Inch Wiring Closet Rail.....	11
3.2 Cabling Requirements	12
3.2.1 Twisted-Pair Ports	12
3.2.2 Fiber Ports.....	12
3.2.3 VLAN Examples	13
3.3 Management.....	14
3.4 Assigning an IP Address.....	14
3.5 Typical Applications	15
4. Web-Based Management.....	18
4.1 Home.....	20
4.2 Configuration	20
4.2.1 System.....	20
4.2.2 Ports.....	22
4.2.3 VLAN Mode.....	23
4.2.4 VLAN Group.....	25
4.2.5 PVID	28
4.2.6 Aggregation	29
4.2.7 Mirror.....	30
4.2.8 Quality of Service	31
4.2.9 Bandwidth Management	37
4.2.10 Trap Event.....	40
4.2.11 Maximum Packet Length	42
4.3 Monitoring.....	43
4.3.1 Statistics Overview	43
4.3.2 Detailed Statistics.....	44
4.4 Maintenance	46
4.4.1 Status	46
4.4.2 Warm Restart	55

Chapter	Page
4.4.3 Factory Default	56
4.4.4 Logout.....	57
5. Troubleshooting	58
5.1 Problems You May Experience.....	58
5.2 Calling Black Box	59
5.3 Shipping and Packaging	59

1. Specifications

Standards: IEEE 802.3/802.3ab/802.3u/802.3x/802.1q only

Speed: LGB2003A: 10/100/1000 Mbps; LGB200C-MLC, LGB200C-SLC10, LGB200C-SLC30: 1000 Mbps

Distance (Maximum): LGB2003A: 328 ft. (100 m) over Category 5 or 5e unshielded twisted-pair cable;
LGB200C-MLC: Up to 960 ft. (300 m) over 850-nm multimode fiber;
LGB200C-SLC10: Up to 6.3 mi. (10 km) over 1310-nm single-mode fiber;
LGB200C-SLC30: Up to 18.9 mi. (30 km) over 1550-nm single-mode fiber

Forwarding/Filtering Rate: 14,800 pps at 10 Mbps, 148,800 pps at 100 Mbps, 1,488,000 pps at 1000 Mbps

MAC Addresses: 8 K, 4K VLAN table entries

Flow Control: IEEE 802.3x compliant for full duplex, backpressure flow control for half-duplex

User Controls: Reset button

Connectors: LGB2003A: (24) 10/100/1000-Mbps twisted-pair RJ-45 female, (2) Gigabit twisted-pair/SFP fiber slots for fiber modules, (1) power connector;
LGB200C-MLC, LGB200C-SLC10, LGB200C-SLC30: (2) LC

Indicators: (51) LEDs: (1) Power, (24) 10/100/1000-Mbps twisted-pair ports 1–24, (24) Link/Act, (2) 1000-Mbps SFP fiber ports 23–24

Temperature Tolerance: 32 to 122°F (0 to 50°C)

Relative Humidity: Up to 90%

Power: 100–240 VAC, 50–60 Hz

Size: 1.7"H x 17.3"W x 8.2"D (4.3 x 43.9 x 20.8 cm)

2. Overview

2.1 Introduction

The Managed 24-Port 10/100/1000 Ethernet Switch with 2 SFP (Small Fiber Port) Dual Media meets all IEEE 802.3/802.3ab/802.3u/802.3x/802.1q Gigabit and Fast Ethernet specifications. It has 24 10/100/1000-Mbps twisted-pair ports and 2 Gigabit twisted-pair/SFP fiber slots for fiber modules. Connect 24 10/100/1000 twisted-pair devices, 23 10/100/1000 twisted-pair and one fiber device, or 22 10/100/1000 twisted-pair and two fiber devices to the switch. Manage the switch through an Ethernet port using Web-based management. The network administrator can logon to the switch to monitor, configure, and control each port's activity.

Ports 23 and 24 autodetect two media types: 10/100/1000-Mbps twisted pair and 1000-Mbps Small Fiber Port (SFP) fiber. An SFP fiber transceiver module is used for high-speed connection expansion. The 1000-Mbps SFP fiber transceivers are Gigabit Ethernet ports that fully comply with all IEEE 802.3z and 1000BASE-SX/LX standards. The switch is compatible with the following optional fiber modules.

- LC Multimode Fiber Module (LGB200C-MLC) works with 850-nm multimode fiberoptic cable that's up to 960 feet (300 m) long
- LC Single-Mode Fiber Module (LGB200C-SLC10) works with 1310-nm single-mode fiberoptic cable that's up to 6.3 miles (10 km) long
- LC Single-Mode Fiber Module (LGB200C-SLC30) works with 1550-nm single-mode fiberoptic cable that's up to 18.9 miles (30 km) long

The switch features QoS (Quality of Service), VLAN, and trunking. QoS enables the switch to support the ToS field of an IP header (equal DSCP low 3 bits) on Layer 3 of network framework and six kinds of special network transmission events on Layer 4. With VLAN, the switch supports port-based VLAN and IEEE802.1Q Tag VLAN. It also supports 24 active VLANs and VLAN ID 1–4094. Port trunking allows one or more links to be aggregated together to form a Link Aggregation Group by the static setting.

2.2 Components

2.2.1 FRONT PANEL

The 24 10/100/1000-Mbps twisted-pair ports and 2 Gigabit twisted-pair/SFP fiber slots for fiber modules are on the switch's front panel. The LED display area on the panel's left side contains a Power LED, 24 10/100/1000-Mbps twisted-pair ports LEDs, 24 Link/Act LEDs, and 2 1000-Mbps SFP fiber ports 23–24 LEDs. The numbered components in Figure 2-1 correspond to the descriptions in Table 2-1.

MANAGED 24-PORT 10/100/1000 ETHERNET SWITCH WITH 2 SFP DUAL MEDIA

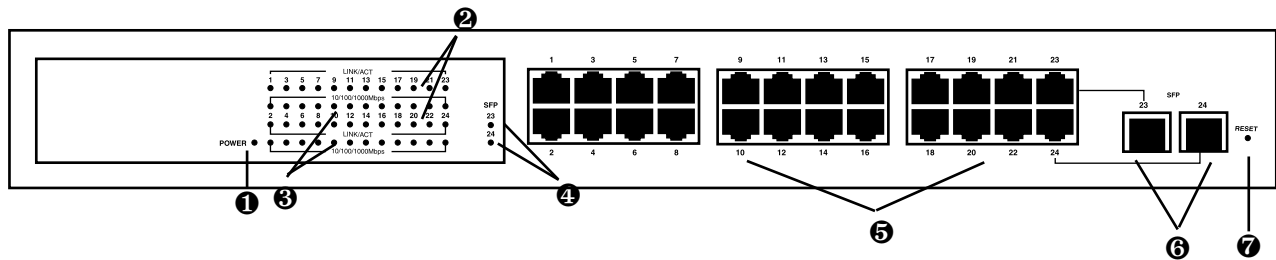

Figure 2-1. Front panel.

Table 2-1. Front-panel indicators, connectors, and button.

Component	Description
① Power LED	Lights when the power is on.
② Link/Act LEDs	Light when connection to remote device is good. Blink when any traffic is present. Off when the module connection is not good.
③ 10/100/1000-Mbps LEDs	Green when 1000 Mbps speed is active. Amber when 100 Mbps speed is active. Off when 10 Mbps speed is active.
④ 1000-Mbps SFP fiber ports 23–24 LEDs	Light when connection to the remote device is good. Blink when any traffic is present. Off when the module connection is not good.
⑤ Gigabit Ethernet Ports	24 RJ-45 female connectors attach to network devices.
⑥ SFP Fiber Ports	Consists of 2 slots for fiber modules.
⑦ Reset button	Pressing this button restores the system default setting.

2.2.2 REAR PANEL

The switch's back panel features a receptacle for a 100–240-VAC, 50-/60-Hz power cord.

2.3 What's Included

Your package should include the following items. If anything is missing or damaged, contact Black Box at 724-746-5500.

- (1) Managed 24-Port 10/100/1000 Ethernet Switch with 2 SFP Dual Media
- (1) AC power cord
- (2) Mounting brackets
- (8) Screws
- (4) Rubber feet with adhesive backing
- (1) CD-ROM containing this user's manual in PDF format

3. Installation

3.1 Hardware and Cable Installation

Before installing the switch, make sure you are wearing a grounding strap to avoid damage caused by electrostatic discharge. Also, confirm that the power switch is off before you insert the power cord into the power receptacle.

3.1.1 INSTALLING THE OPTIONAL MODULES

NOTE

If you are not installing modules in Ports 23–24, skip this section.

1. Verify that the SFP module is the right model and conforms to the chassis.
2. Slide the module into the slot as shown in Figure 3-1. Make sure that the module is properly seated against the slot socket/connector.

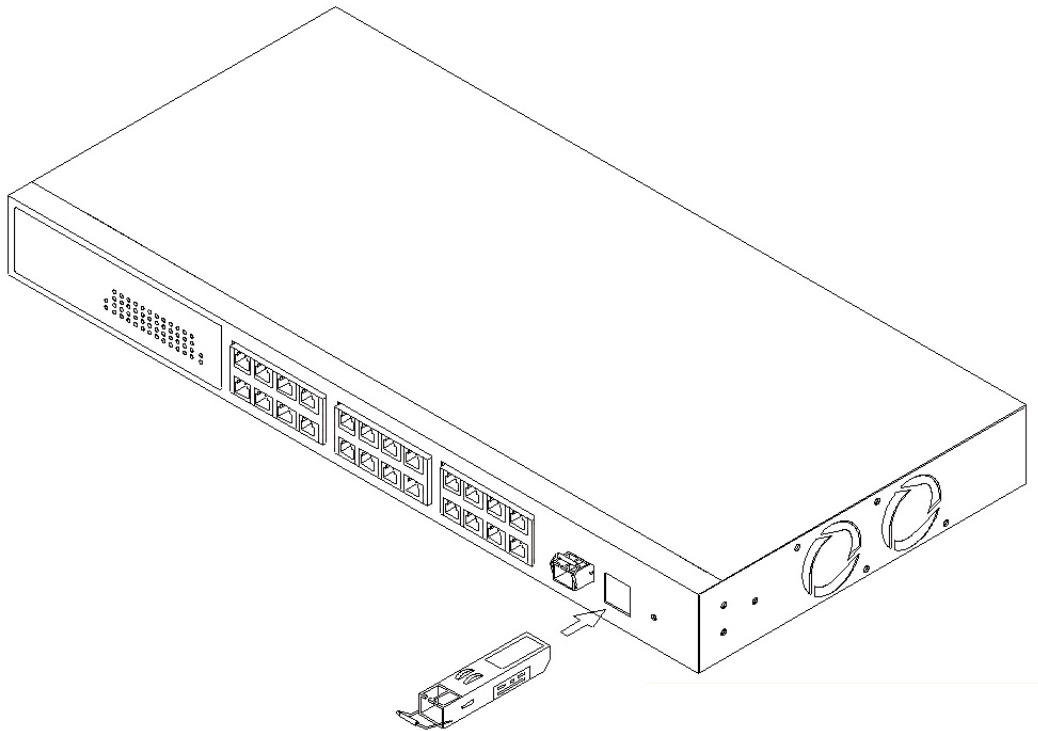

Figure 3-1. Installing an optional SFP fiber transceiver in the switch.

3. Install the fiber optic cable (see **Section 3.1.2**) for network connection.
4. Repeat the above steps for the second module and slot, if needed.
5. Power on the switch.

3.1.2 CONNECTING THE CABLE

The switch's twisted-pair ports support MDI/MDI-X auto-crossover, so you can use either straight-through or cross-pinned UTP cable.

Use Category 5 or 5e grade RJ-45 twisted-pair cable to connect up to 24 network devices (such as workstations or servers) to the switch's UTP ports.

Use 850- μ m multimode, 1310- μ m single-mode, or 1550- μ m single-mode fiberoptic cable to connect the fiber module to the network.

3.1.3 POWERING ON THE SWITCH

The switch supports a 100–240-VAC, 50–60-Hz power supply. The power supply will automatically convert the local AC power source to DC power. It doesn't matter whether any devices are plugged into the switch or not when you power on the switch (including modules). Once the power is on, all LEDs (except for the Power LED) will light immediately and then turn off. The Power LED will remain on.

After resetting, the bootloader will load the firmware into memory. This takes approximately 30 seconds. After that, all LEDs will flash once and the switch will automatically run a self-test.

3.1.4 INSTALLING THE CHASSIS ON A DESKTOP

Attach the four included rubber feet to the switch's bottom. Then place the switch on a desktop.

3.1.5 INSTALLING THE CHASSIS INTO A 19-INCH WIRING CLOSET RAIL

CAUTION

Allow extra space for proper air ventilation for the cooling fan on both sides of the chassis.

1. Wear a grounding strap to guard against electrostatic discharge.
2. Position the mounting brackets (included) on the switch's front panel.
3. Attach four of the supplied mounting screws (two on the left, two on the right) to the switch's sides to hold the bracket in place (see Figure 3-2).

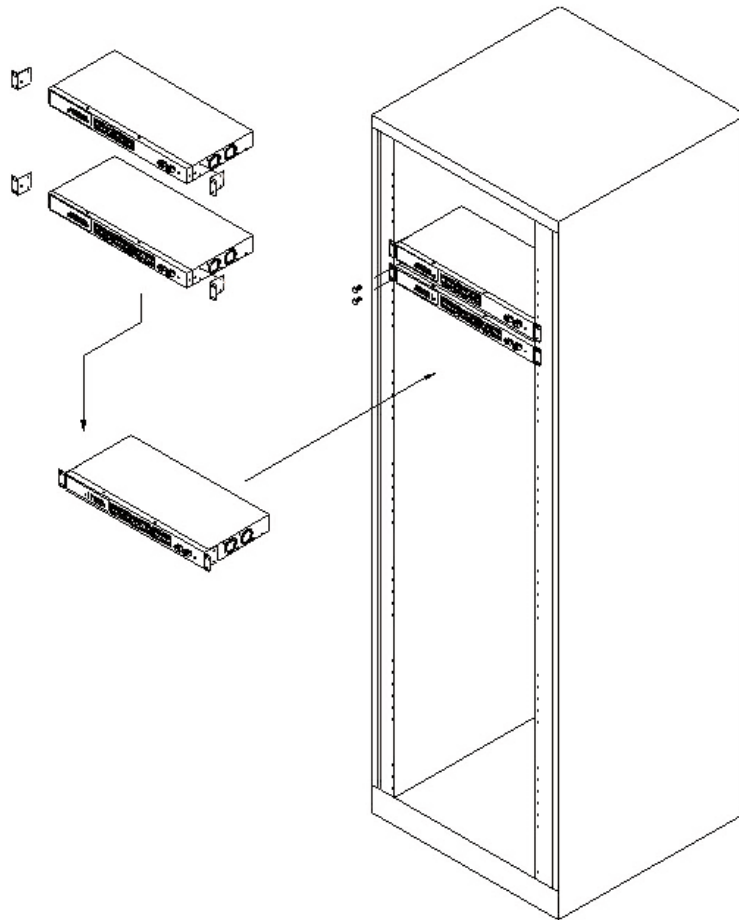

Figure 3-2. Chassis installation.

4. Position the chassis with mounting brackets attached in the 19-inch wiring closet rail.
5. Use the four remaining screws to connect the bracket-mounted chassis to the rail, then tighten the screws.

3.2 Cabling Requirements

3.2.1 TWISTED-PAIR PORTS

For either a Fast Ethernet or Gigabit Ethernet twisted-pair network connection, use Category 5 or 5e cable that's 328 feet (100 m) long or shorter. We recommend Category 5e cable for Gigabit Ethernet networks.

3.2.2 FIBER PORTS

Connect multimode fiber to the LGB200C-MLC module. Use single-mode fiber for the LGB200C-SLC10 or LGB200C-SLC30.

3.2.3 VLAN EXAMPLES

If VLAN is enabled and configured, each network node that can communicate with each other directly is bound in the same VLAN area.

Example 1: Port-based VLAN

In Figure 3-3, VLAN is defined by what VLAN you are using. The switch supports both port-based VLAN and tag-based VLAN. They are different in practical use, especially in physical location.

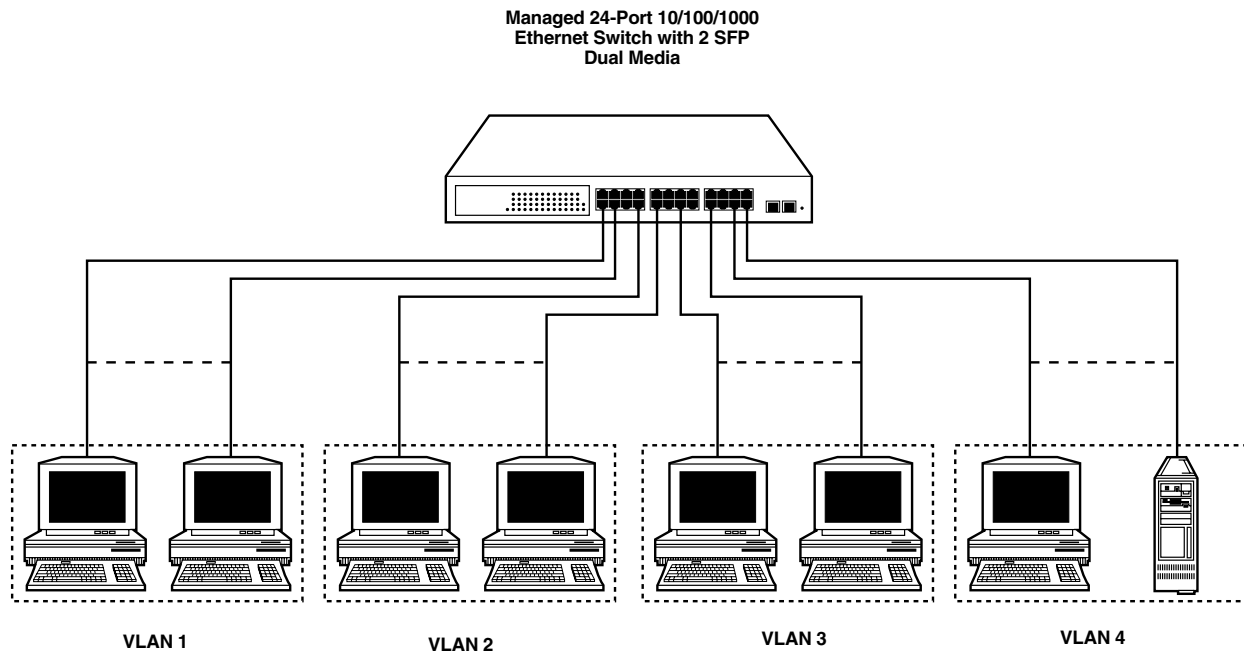

Figure 3-3. Port-based VLAN.

In this example:

- The same VLAN members can't be located on different switches.
- Every VLAN member can't access all other VLAN members.
- The switch manager has to assign different names for each VLAN group at one switch.

MANAGED 24-PORT 10/100/1000 ETHERNET SWITCH WITH 2 SFP DUAL MEDIA

Example 2. The same VLAN members can be at different switches with the same VID (see Figure 3-4)

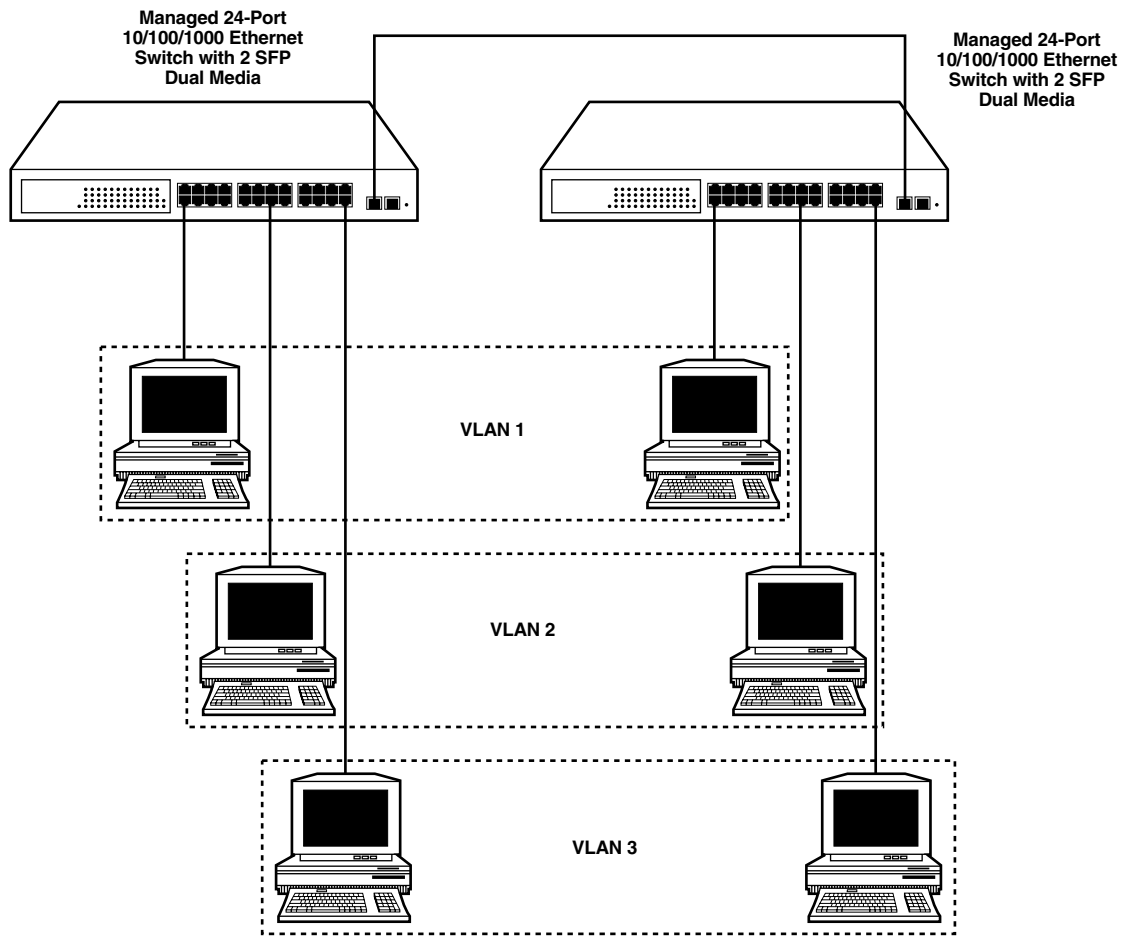

Figure 3-4. Attribute-based VLAN diagram.

3.3 Management

Configure and monitor the switch in two ways: via the switch's SNMP management port or via a Web browser. **Chapter 4** explains how to access and use the Web-based management interface. SNMP management is not described in this manual since it depends on your network management system.

3.4 Assigning an IP Address

For IP address configuration, you need to type in three parameters: IP address, subnet mask, and default gateway. Your system administrator can tell you what these values are for your network. See Figure 4-2 in **Chapter 4**.

3.5 Typical Applications

Three sample setups are shown in Figures 3-5 through 3-7.

In Figure 3-5, the switch is connected to Gigabit Ethernet devices or segments via auto MDI-X. It also uses the two fiber module slots for LC fiber connections.

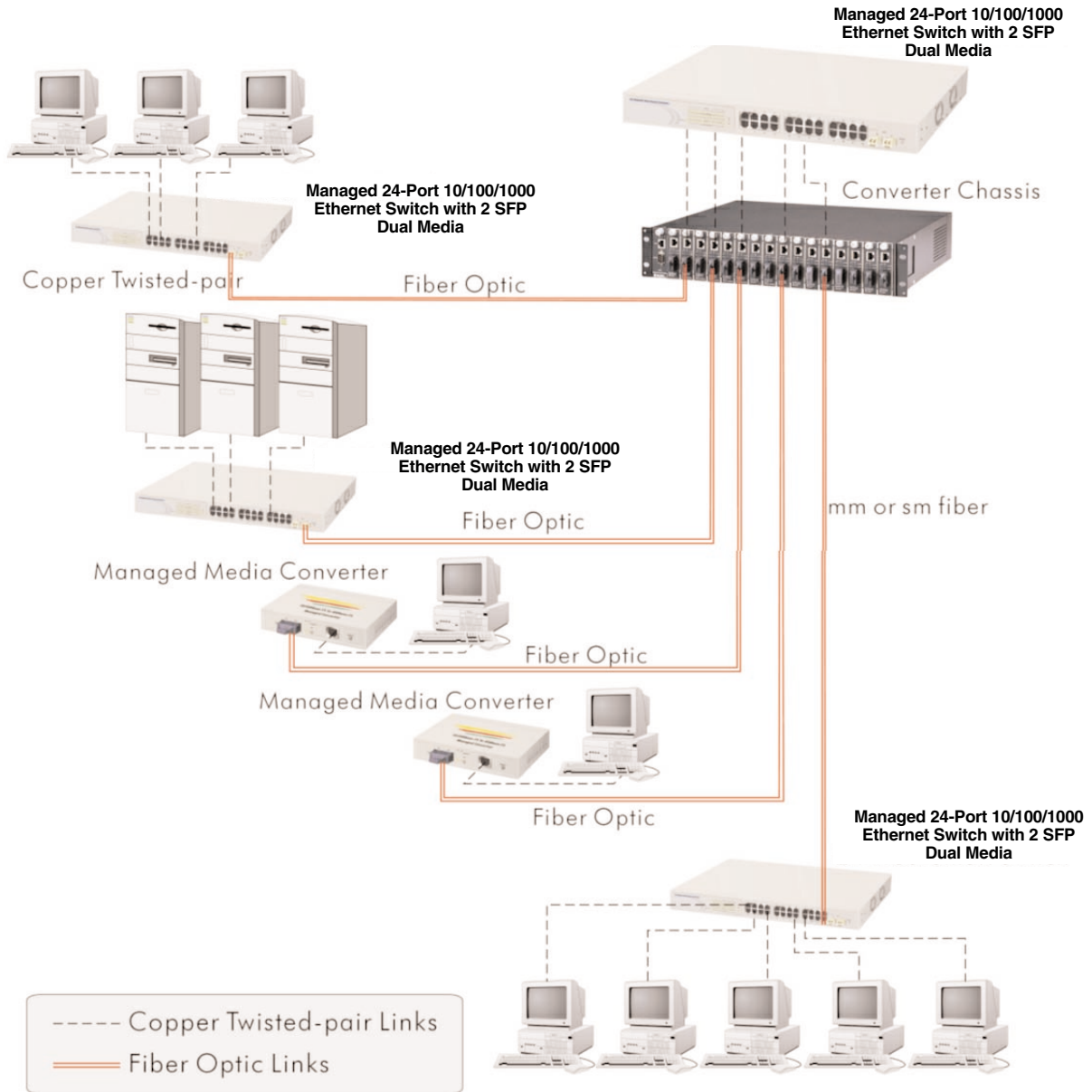

Figure 3-5. Network connection between the remote site and the central site.

MANAGED 24-PORT 10/100/1000 ETHERNET SWITCH WITH 2 SFP DUAL MEDIA

Figure 3-6 shows a peer-to-peer connection.

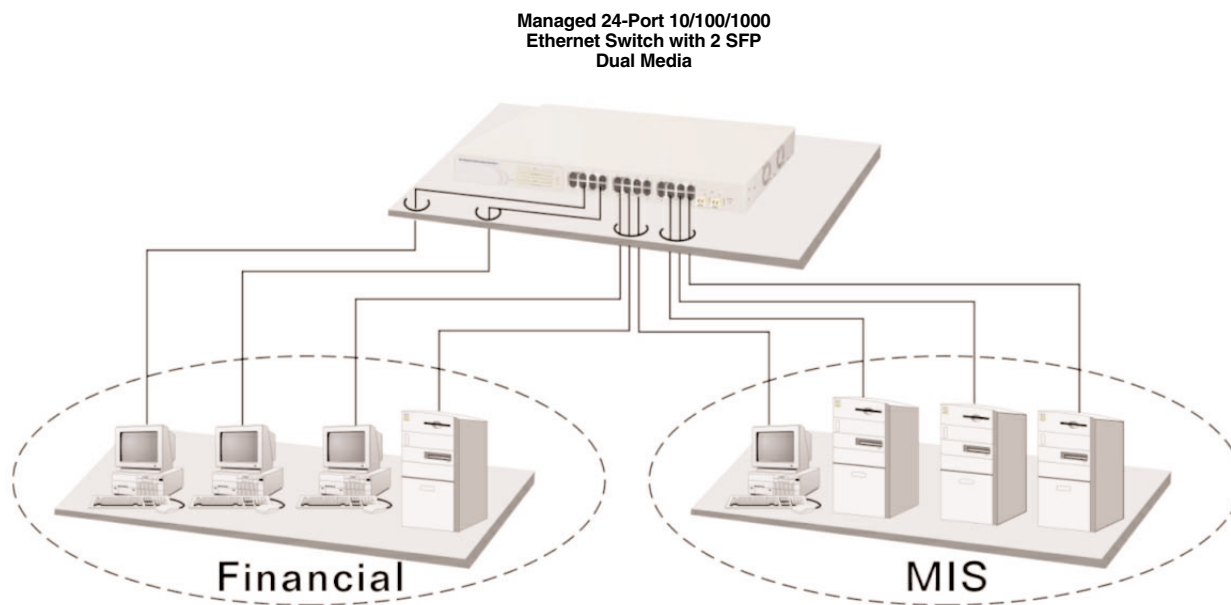

Figure 3-6. Peer-to-peer network connection.

Figure 3-7 illustrates how the switch connects with other network devices and hosts.

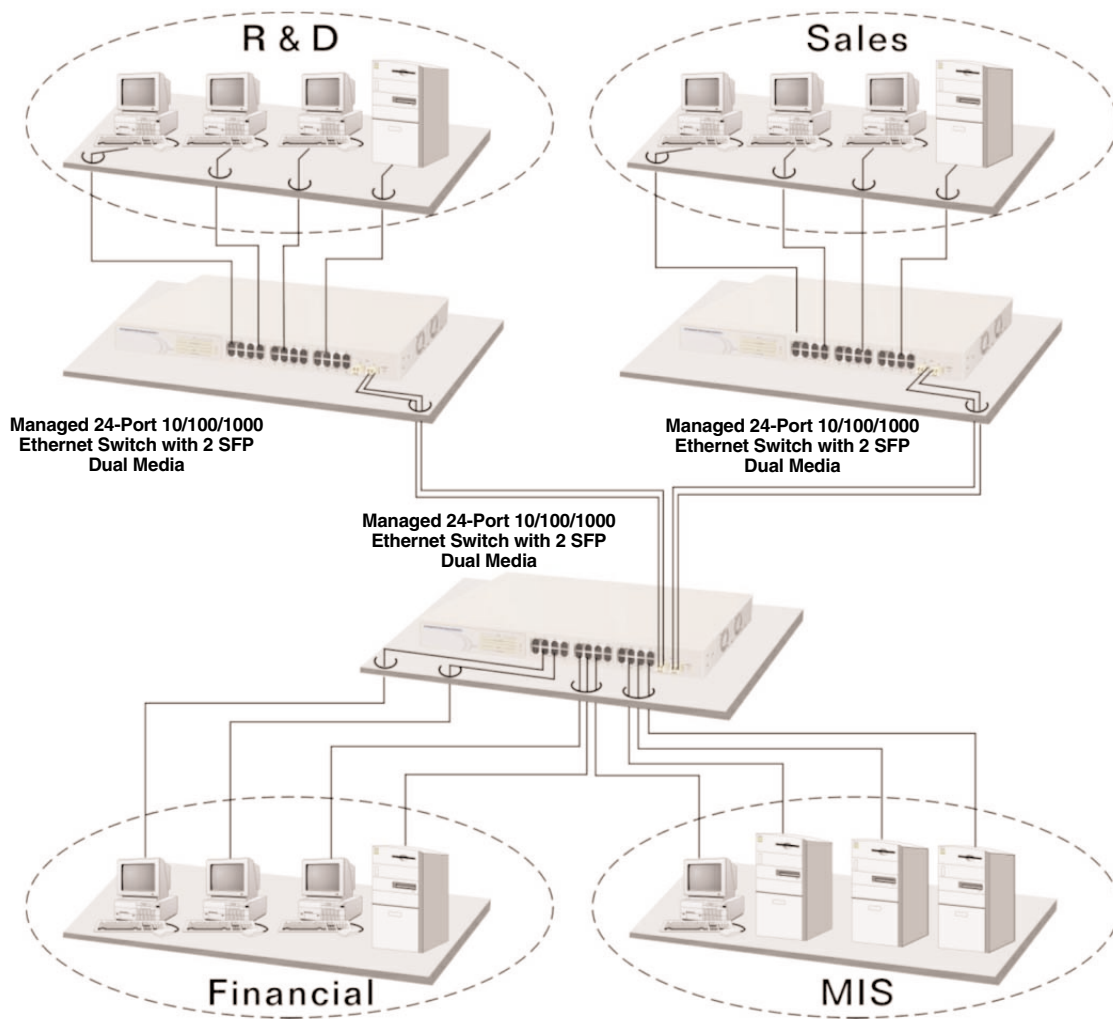

Figure 3-7. Office network connection.

4. Web-Based Management

The first thing you need to do before configuring and monitoring your switch is set the switch's IP address. To do this, connect the switch to the management PC via a Category 5 UTP cable with an RJ-45 connector. Then run the Web browser and follow the menus.

The default values for the Managed 24-Port 10/100/1000 Ethernet Switch with 2 SFP Dual Media are listed below.

IP Address: 192.168.1.1

Subnet Mask: 255.255.255.0

Default Gateway: 192.168.1.254

Password: admin

1. Use the Web-browser interface by first typing in the default IP address:

(http://192.168.1.1)

in the address row in the browser.

A screen like the one shown in Figure 4-1 appears.

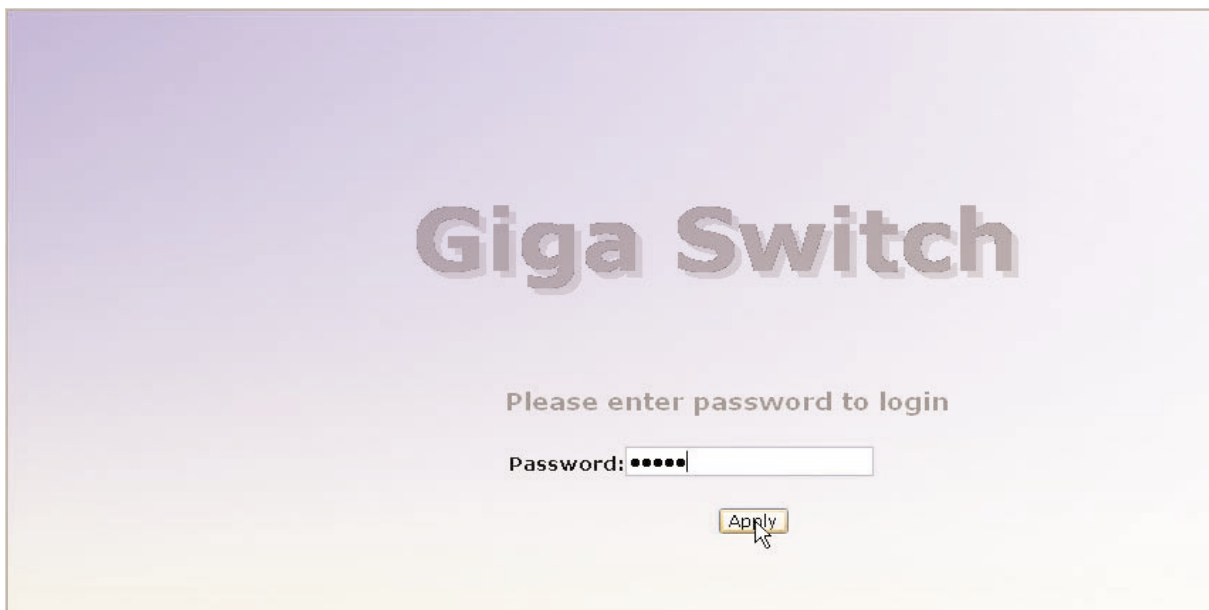

Figure 4-1. Login screen.

2. Type in the default password, admin, then click on the **Apply** button. The System Configuration screen appears (see Figure 4-2).

- To assign an IP address that's different from the default you typed in step 1, check to see what the IP address is for the network connected to the switch (ask your system administrator). Use this network address. The default IP address is shown in Figure 4-2.

System Configuration	
MAC Address	00-40-c7-e6-00-12
Firmware Version	v1.07
Hardware Version	v1.01
Serial Number	030A01000019
IP Address	192.168.1.1
Subnet Mask	255.255.255.0
Default Gateway	192.168.1.254
System Name	Giga Switch
Password	•••••
Auto Logout Timer (mins)	0

Figure 4-2. System Configuration screen.

- Type in the subnet mask, such as 255.255.255.0, and the default gateway (192.168.1.254).
- Type in the system name (the default is Giga Switch), then your password (the default password is admin). Click on the **Apply** button.
- This completes the login procedure. The Home page (Figure 4-3) appears.

For a description of the other options shown in the System Configuration screen (MAC address, firmware version, hardware version, serial number, and auto logout timer), go to **Section 4.2.1**.

4.1 Home

After you log in, the switch displays the system status information shown in Figure 4-3. This page is the default and tells you the system's basic information, such as system status, TP port status, and fiber port status.

The screenshot shows the 'Giga Switch' home page. At the top left is the title 'Giga Switch'. Below it is a navigation menu with three main categories: Configuration, Monitoring, and Maintenance. The Configuration menu includes links for System, Ports, VLAN Mode, VLAN Group, PVID, Aggregation, Mirror, Quality of Service, Bandwidth Management, Trap Event, and Max. Packet Length. The Monitoring menu includes Statistics Overview and Detailed Statistics. The Maintenance menu includes Status, Warm Restart, Factory Default, and Logout. The main content area is divided into three sections: System Status, TP Port Status, and a top-right status bar. The System Status section contains a table with system information. The TP Port Status section contains a table with 20 columns representing ports and their status.

System Status	
Product Name	24-Port 10/100/1000M Gigabit SW.
Firmware Version	v1.07
Hardware Version	v1.01
Serial Number	030A01000019
IP Address	192.168.1.1
Subnet Mask	255.255.255.0
Default Gateway	192.168.1.254
MAC Address	00-40-c7-e6-00-12
System Name	Giga Switch
Auto Logout Timer (mins)	0

TP Port Status							
Port	Link Status	Speed	Flow Control	Port	Link Status	Speed	Flow Control
1	100Full	Auto	Enabled	2	Down	Auto	Disabled
3	Down	Auto	Disabled	4	Down	Auto	Disabled
5	Down	Auto	Disabled	6	Down	Auto	Disabled
7	Down	Auto	Disabled	8	Down	Auto	Disabled
9	Down	Auto	Disabled	10	Down	Auto	Disabled
11	Down	Auto	Disabled	12	Down	Auto	Disabled
13	Down	Auto	Disabled	14	Down	Auto	Disabled
15	Down	Auto	Disabled	16	Down	Auto	Disabled
17	Down	Auto	Disabled	18	Down	Auto	Disabled
19	Down	Auto	Disabled	20	Down	Auto	Disabled

Figure 4-3. Home page.

The Home page has a vertical menu on the left side of the screen. Options include Configuration, Monitoring, and Maintenance. These three groups are discussed in Sections 4.2 through 4.4.

4.2 Configuration

Eleven functions are available in the Configuration menu. These are described in Sections 4.2.1 through 4.2.11.

4.2.1 SYSTEM

To get to the System Configuration menu shown in Figures 4-2 and 4-4, click on **System** in the Configuration menu on the Home page.

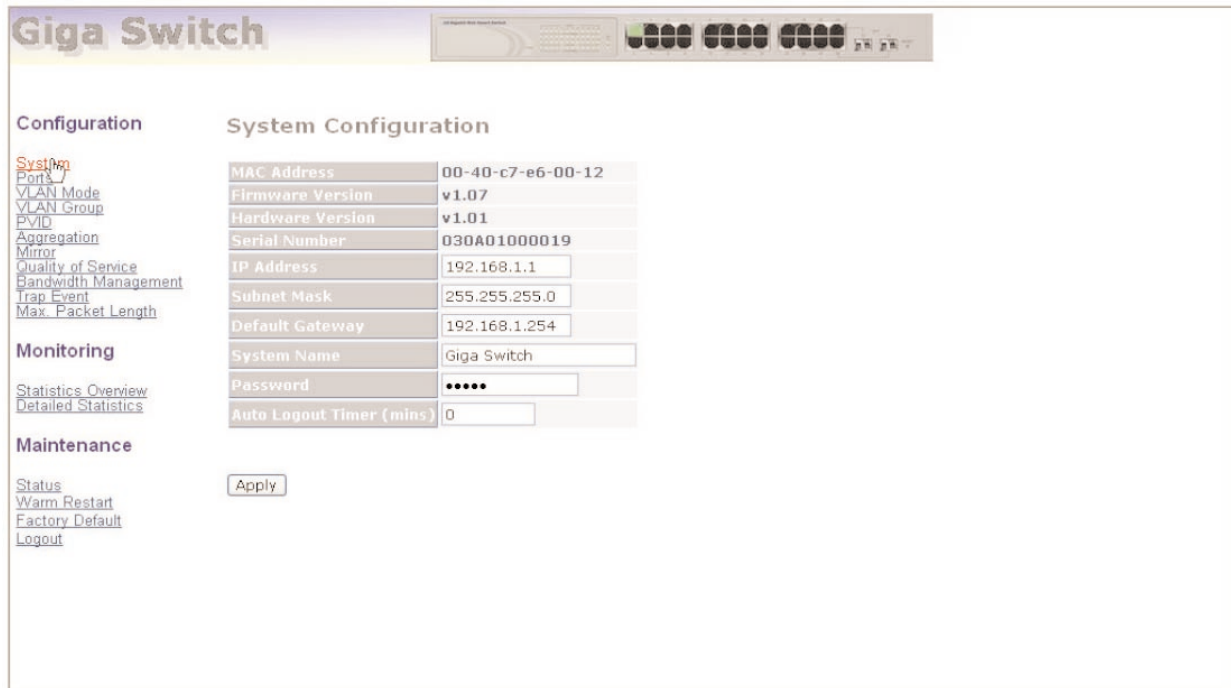

Figure 4-4. System Configuration screen.

Table 4-1 describes the options shown in Figure 4-4. You already set the IP address, subnet mask, default gateway, and password options in the screen, but you can change them here.

Table 4-1. System Configuration screen options.

Parameter	Description
MAC Address	This is the MAC address of the switch's management agent.
Firmware Version	The switch's firmware version.
Hardware Version	The switch's hardware version.
Serial Number	The serial number assigned by the manufacturer.
IP Address	You can configure the IP address and fill in new values. Click on the Apply button to update. The default IP address is 192.168.1.1.
Subnet Mask	You can configure the subnet mask by typing in new values. Click on the Apply button to update. The default subnet mask is 255.255.255.0.
Default Gateway	If a packet does not meet the routing requirements, it must be forwarded to a default router on a default path. This means that any packet with an undefined IP address in the routing table will be sent to this device unconditionally. The default value is 192.168.1.254.

Table 4-1 (continued). System Configuration screen options.

Parameter	Description
System Name	Giga Switch is the name of the switch; it will automatically fill in the System Name field when the System Configuration screen appears.
Password	Type in a password up to 16 characters long. Any alphanumeric characters are acceptable. The default is admin.
Auto Logout Timer (mins)	To set the auto-logout timer, type in a value between 0 and 60 minutes. Do not use a decimal point. When this value is set to zero, the auto-logout timer is disabled.
Apply button	Click on this button to save your changes.

4.2.2 PORTS

Port configuration changes each port's setting. In this mode, you can set/reset mode and flow control. To get to the Port Configuration menu (not shown in this manual), click on **Port** in the Configuration menu on the Home page.

Table 4-2 describes the menu options in the Port Configuration menu.

Table 4-2. Port Configuration menu options.

Parameter	Description
Mode	Set the speed and duplex for each port. If using 1-Gbps fiber, select auto speed, 1000 full duplex, or disable from the drop-down menu. If using twisted pair, options include 10/100/1000 Mbps and full or half-duplex.
Flow Control	Choose Enable or Disable from the drop-down menu. When set to Enable, two users can send a pause frame to the transmitting device if the receiving port is too busy to handle the data. When set to Disable, there's no flow control for the port. The packet is dropped if it's too large.
Apply button	Click on this button to save your changes.
Refresh button	Click on this button to refresh the screen.

4.2.3 VLAN MODE

The switch supports port-based VLAN and tag-based VLAN (802.1q). 24 VLANs can be active with VLAN IDs from 1–4094. VLAN configuration is used to partition your LAN into smaller LANs. This improves security and increases performance. To get to the VLAN Mode screen shown in Figure 4-5, click on **VLAN Mode** in the Configuration menu on the Home screen.

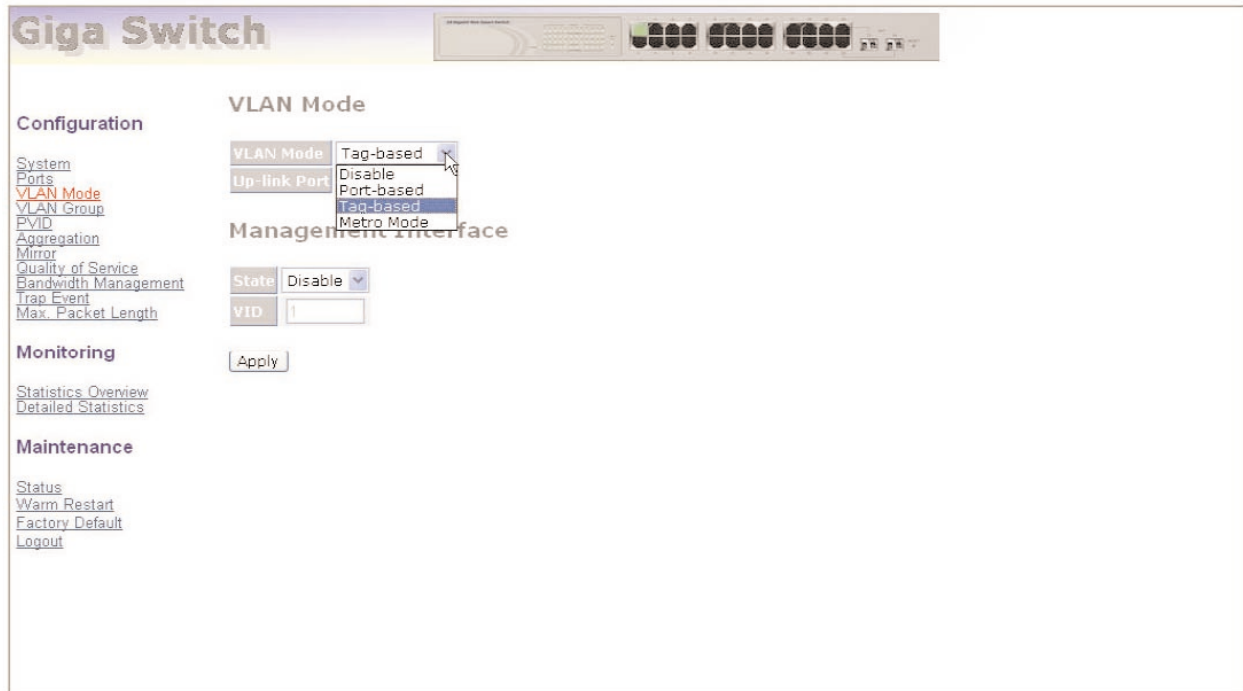

Figure 4-5. VLAN Mode screen.

Table 4-3 describes the options shown in Figure 4-5.

Table 4-3. VLAN Mode screen options.

Parameter	Description
VLAN Mode	<p>Choose Disable, Port-based, Tag-based, or Metro mode from the drop-down menu.</p> <p>Disable will stop the switch’s VLAN function. This is the default setting.</p> <p>Port-based VLAN is defined by port. Any incoming or outgoing packet from any one port of a port-based VLAN will be accepted. For example, suppose you have a port-based VLAN named PVLAN-1 that contains ports 1–4. From port 1 you can communicate with ports 2–4. Each port-based VLAN you build must be assigned a group name. The switch can support up to 24 port-based VLAN groups.</p>

Table 4-3 (continued). VLAN Mode screen options.

Parameter	Description
VLAN Mode (continued)	<p>Tag-based VLANs identify their members by VID. This option considers any Ingress or Egress list filtering rules required for the switch before forwarding a packet.</p> <p>Each tag-based VLAN must be assigned a VLAN name and VLAN ID. Valid VLAN IDs are from 1 to 4094. You can create up to 24 tag-based VLANs.</p> <p>Metro mode is a quick configuration VLAN environment method used for port-based VLANs. It will create 22 or 23 port-based VLAN groups.</p>
Uplink Port	<p>This option is only enabled when you select Metro mode from the drop-down menu in Figure 4-5.</p> <p><i>When you select 23 from the drop-down menu:</i> Except for port 23, each switch port can't transmit packets to each other. Each port groups a VLAN with Port 23, so a total of 23 groups consisting of two members are formed.</p> <p><i>When you select 23 and 24 from the drop-down menu:</i> Except for ports 23 and 24, each switch port can't transmit packets to each other. Each port groups a VLAN with port 23 and port 24. A total of 22 groups consisting of three members are formed.</p>
State	<p>Available only if you choose Tag-based VLAN from the drop-down menu in Figure 4-5. When you select Enable from the drop-down State menu, only tagged packets with this VID can manage the switch.</p>
VID	<p>Type in a value between 1 and 4094.</p>
Apply button	<p>Click on this button to save your changes.</p>

4.2.4 VLAN GROUP

This option shows the existing information for VLAN groups. Choose this option to modify, delete, or add a new VLAN group. To get to the VLAN Group Configuration screen shown in Figure 4-6, click on **VLAN Group** in the Home page.

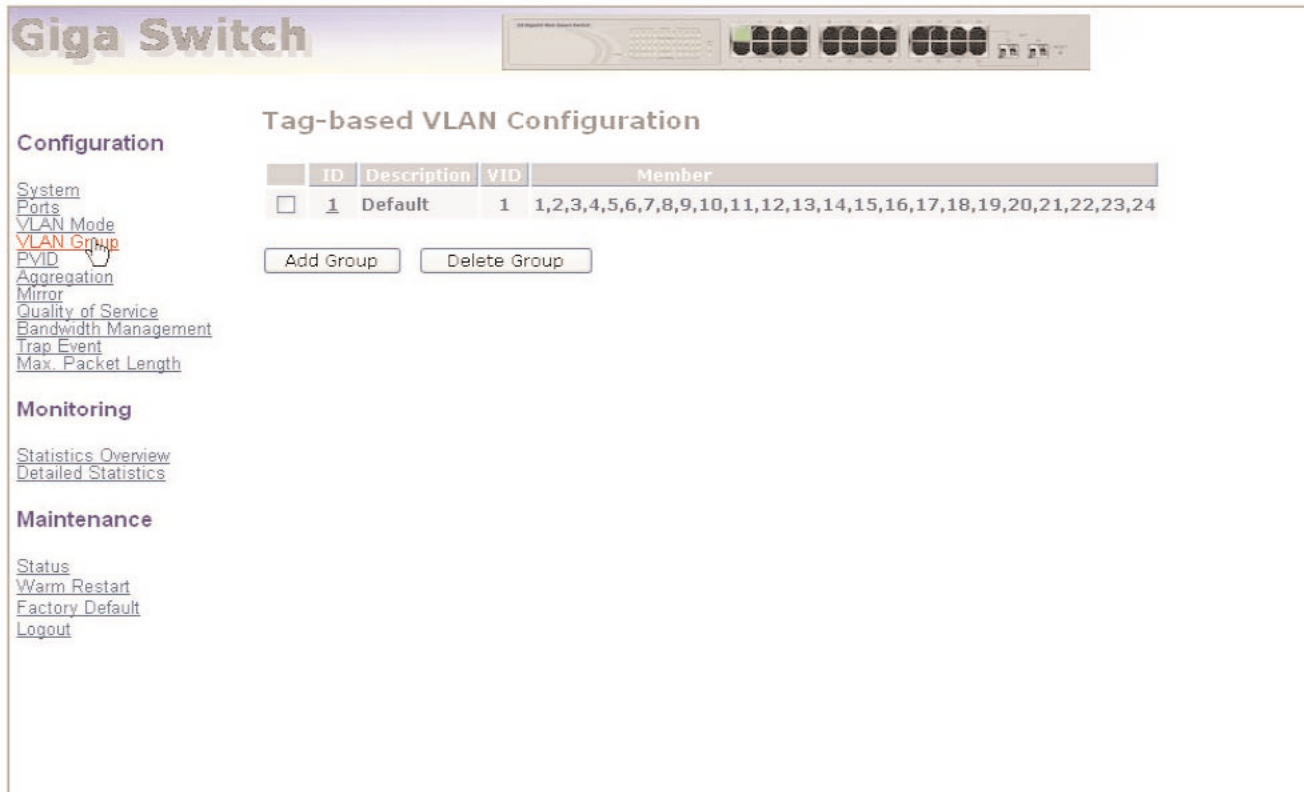

Figure 4-6. Tag-Based VLAN Configuration screen.

MANAGED 24-PORT 10/100/1000 ETHERNET SWITCH WITH 2 SFP DUAL MEDIA

Table 4-4 describes the options shown in Figure 4-6.

Table 4-4. Tag-Based VLAN Configuration screen options.

Parameter	Description
ID (Group ID)	To edit a VLAN, check the box to the left of the ID field.
Description	This field contains the description defined by the system administrator.
VID	Each tag-based VLAN has a unique VID.
Member	Lists the group members. To enable this option, click on the box in Figure 4-6.
Add Group button	Click on this button to add a group. Additional information is provided below.
Delete Group button	Click on this button to delete a group. Additional information is provided on the next page.

Add Group

When you click on **Add Group** in Figure 4-6, the screen shown in Figure 4-7 appears. Type in a new VLAN description and VID. Check the boxes next to the port numbers for the ports that you want to include in the new VLAN. Then click on the **Apply** button.

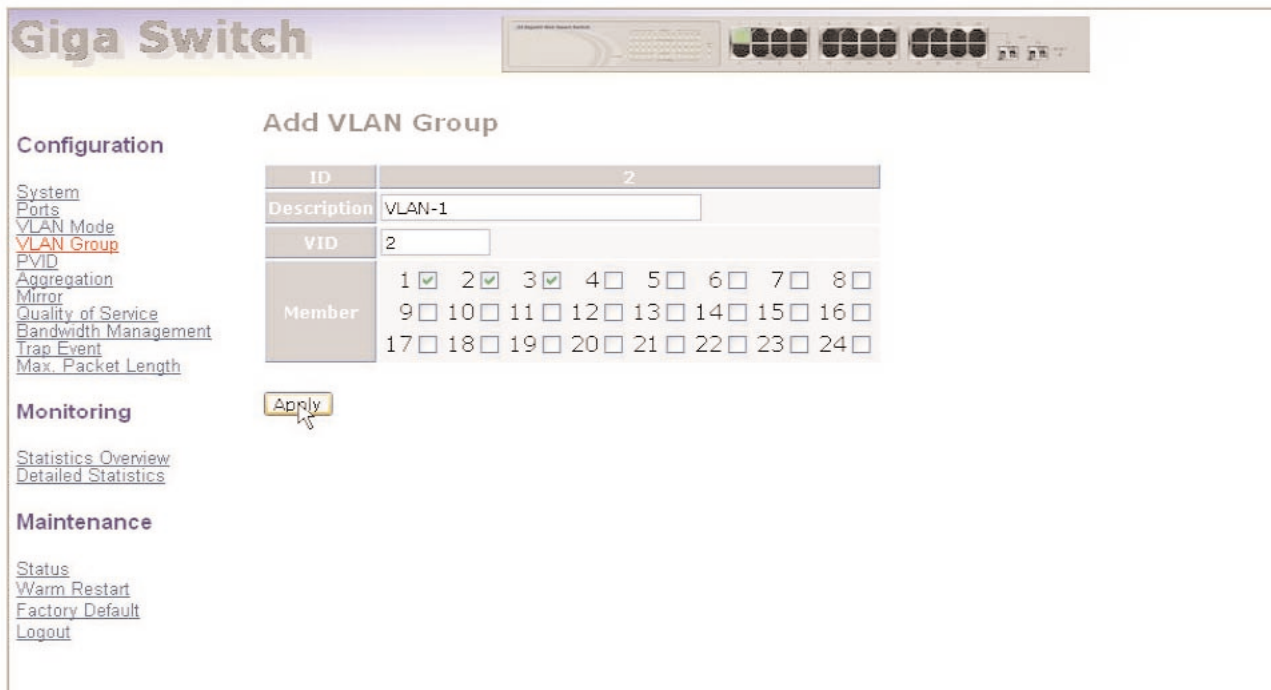

Figure 4-7. Add VLAN Group screen.

Delete Group

When you click on **Delete Group** in Figure 4-6, the screen shown in Figure 4-8 appears. Click on the box to the left of the ID for the group that you want to delete, then click on the **Delete Group** button to delete that group. Or, click on the **Add Group** button to go back to Figure 4-7.

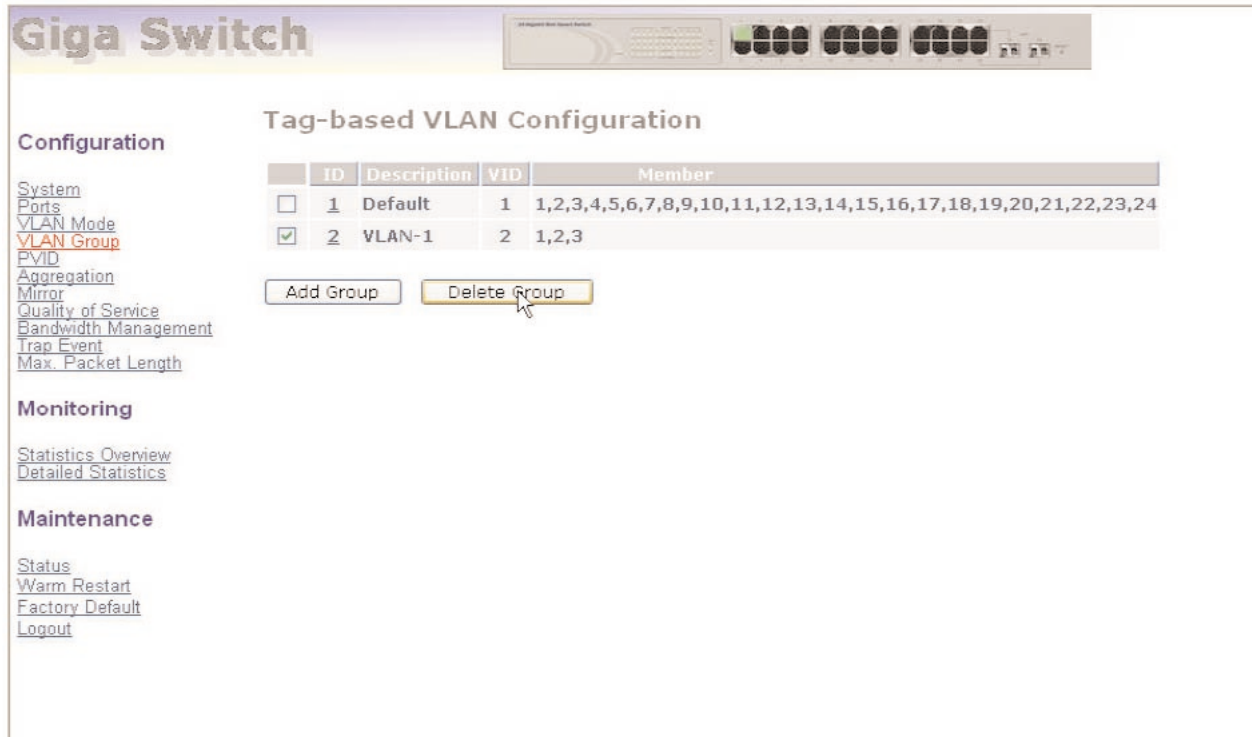

Figure 4-8. Delete VLAN Group screen.

MANAGED 24-PORT 10/100/1000 ETHERNET SWITCH WITH 2 SFP DUAL MEDIA

4.2.5 PVID

Set a VID number from 1 to 4094 for each port. Choose Ingress filtering rules for each port. Two Ingress filtering rules apply to the switch. Ingress filtering rule 1 is “forward only packets with VID matching this port’s configured VID.” Ingress filtering rule 2 is “drop untagged frame.” To get to the PVID Configuration screen shown in Figure 4-9, click on **PVID** in the Configuration menu shown in the Home screen.

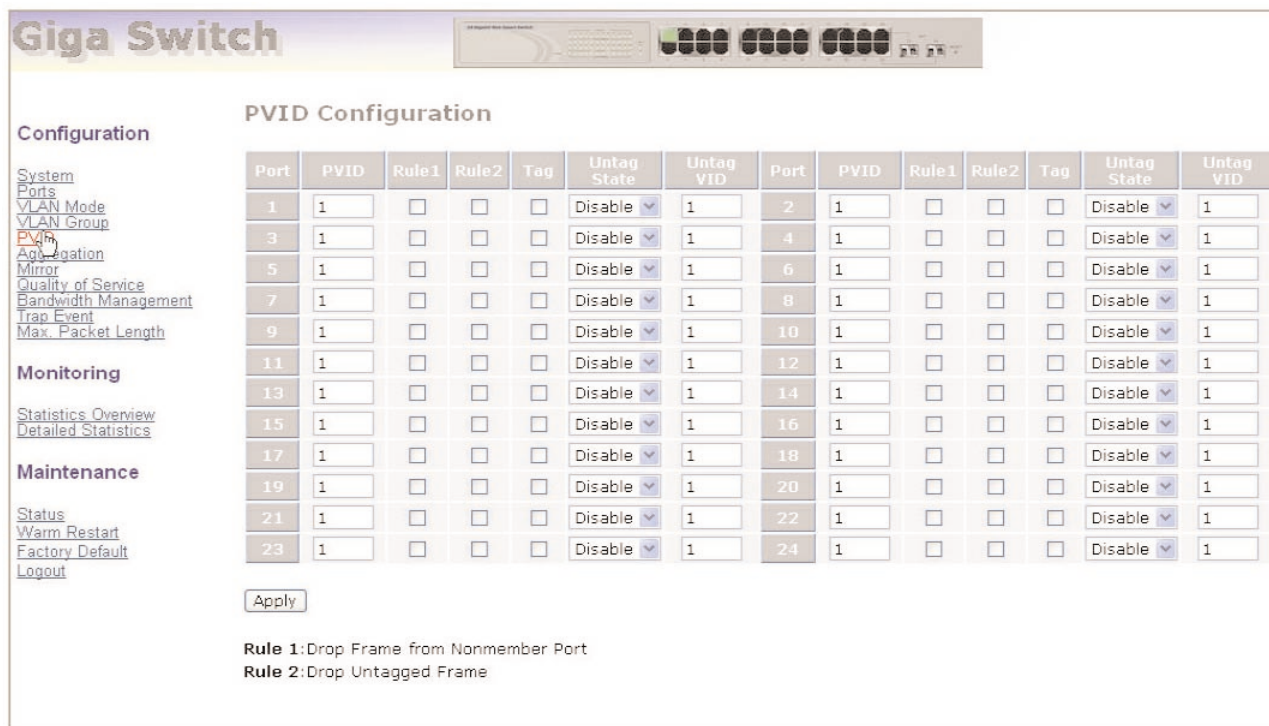

Figure 4-9. PVID Configuration screen.

Table 4-5 describes the options shown in Figure 4-9.

Table 4-5. PVID Configuration options.

Parameter	Description
Port 1–24	Lists port numbers from 1 to 24.
PVID	Select a PVID value between 1 and 4094. First, create a tag-based VLAN with VID x. For example, if port x receives an untagged packet, the switch will apply the PVID (for example, VID y) of port x to tag this packet. The packet will then be forwarded as the tagged packet with VID y.
Rule 1	Check this box to forward only packets with VIDs matching this port’s configured VID.
Rule 2	Check this box to drop the untagged frame.

Table 4-5 (continued). PVID Configuration options.

Parameter	Description
Tag	Check this box to require that outgoing packets contain the VLAN tag header.
Untag State	Choose Enable or Disable from the drop-down menu.
Untag VID	Type in a number between 0 and 4094.
Apply button	Click on this button to save your changes.

4.2.6 AGGREGATION

The Aggregation (Port Trunking) Configuration screen is used to configure the switch’s link aggregation settings. Bundle more than one port with the same speed, full duplex, and the same MAC into a single logical port. For example, if there are three Fast Ethernet ports aggregated in a logical port, the resulting logical port has bandwidth three times as high as a single Fast Ethernet port’s bandwidth.

To get to the Aggregation/Trunking Configuration screen shown in Figure 4-10, click on **Aggregation** in the Configuration menu shown in the Home page.

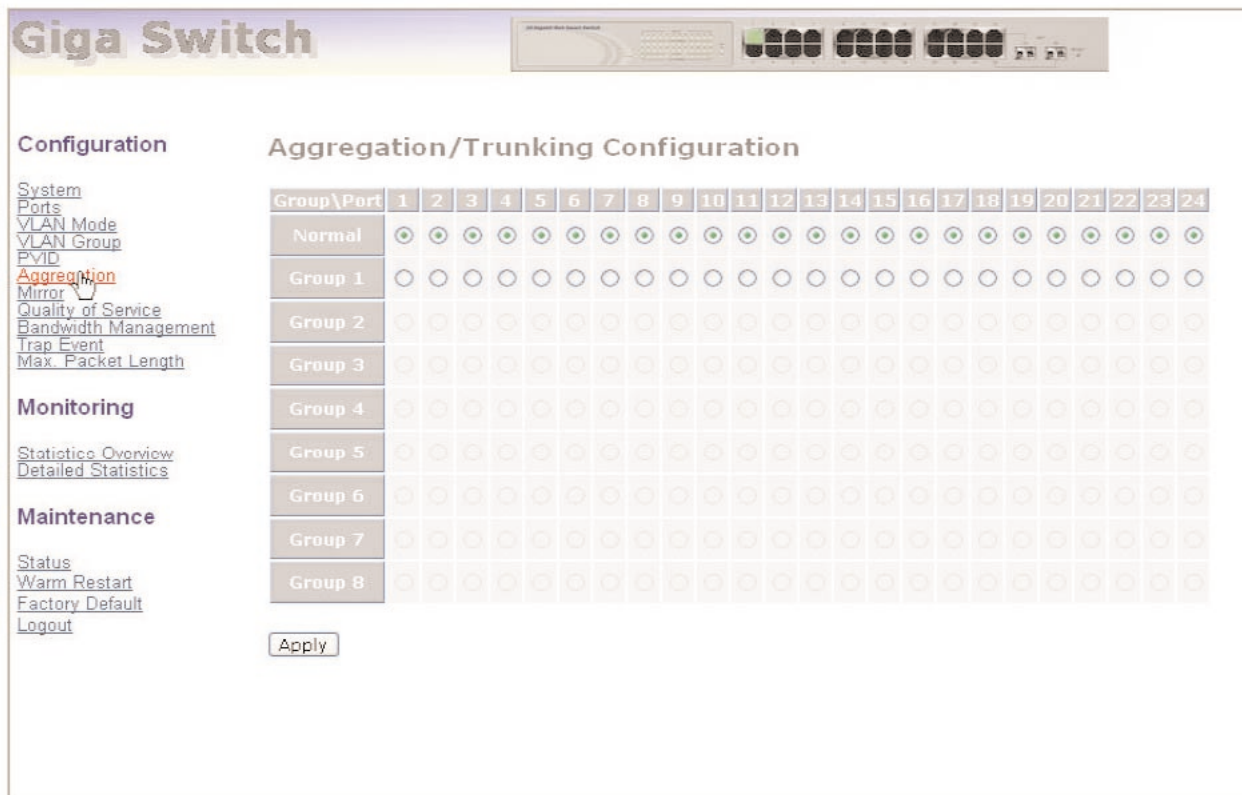

Figure 4-10. Aggregation/Trunking Configuration screen.

Table 4-6 explains the options shown in Figure 4-10.

Table 4-6. Aggregation/Trunking Configuration options.

Parameter	Description
Normal	Click on this button to set up the ports that do not join any aggregation trunking group.
Group 1–8	Click on these buttons to group chosen ports together. Up to 8 ports can be selected for each group.
Apply button	Click on this button to save your changes.

4.2.7 MIRROR

Mirror configuration monitors the network traffic. For example, if port A and port B are the sniffer port and source port respectively, the traffic passed by port B will be copied to port A for monitoring.

NOTE

When configuring the mirror function, avoid setting a port as a sniffer port and an aggregated port at the same time.

To get to the Mirror Setting screen shown in Figure 4-11, click on **Mirror** in the Configuration menu from the Home page.

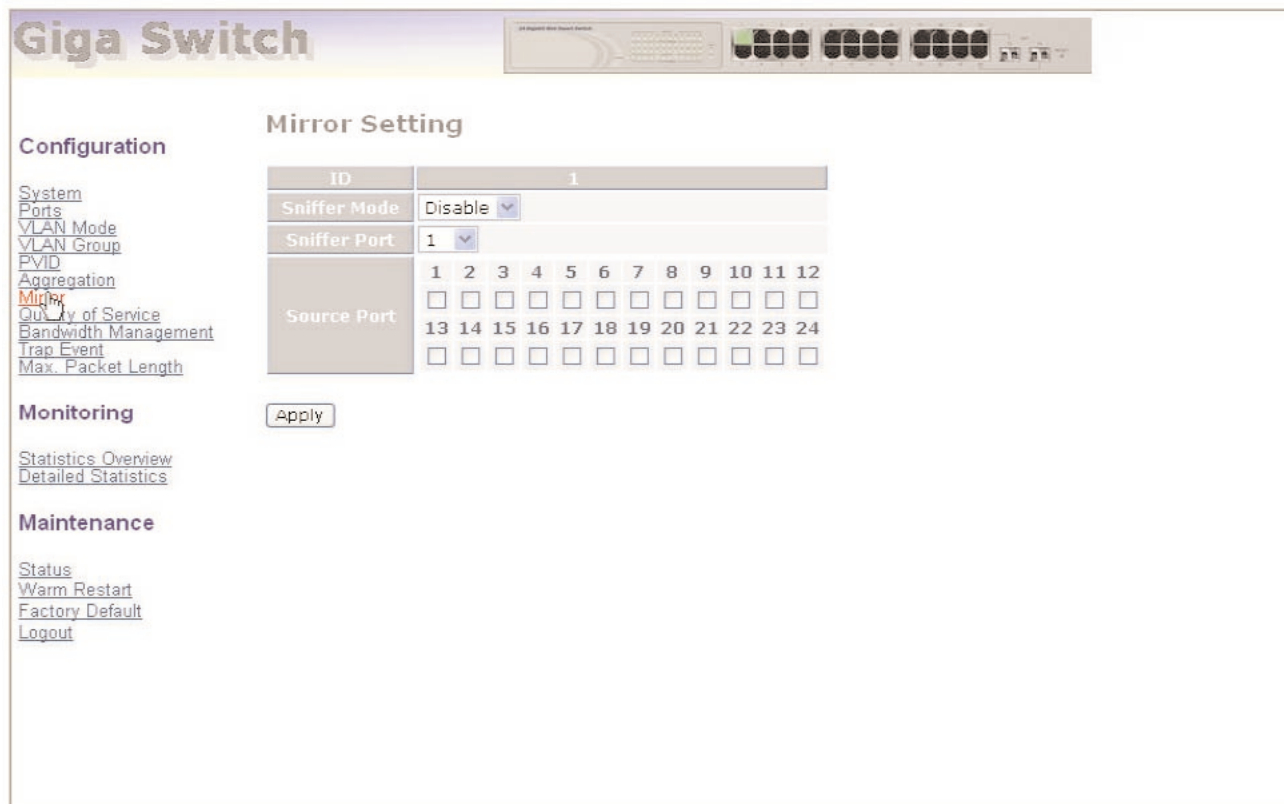

Figure 4-11. Mirror Setting screen.

Table 4-7 describes the options shown in Figure 4-11.

Table 4-7. Mirror Setting screen options.

Parameter	Description
Sniffer Mode	From the drop-down menu, enable or disable the port mirror function.
Sniffer Port	Choose a port (1–24) from the drop-down menu for monitoring. The default is port 1.
Source Port	Check the box underneath the port you want to choose.
Apply button	Click on this button to save your selections.

4.2.8 QUALITY OF SERVICE

The switch’s QoS function supports VLAN-tagged priority for up to 8 priorities. To get to the screen shown in Figure 4-12, click on **Quality of Service** in the Configuration menu on the Home page.

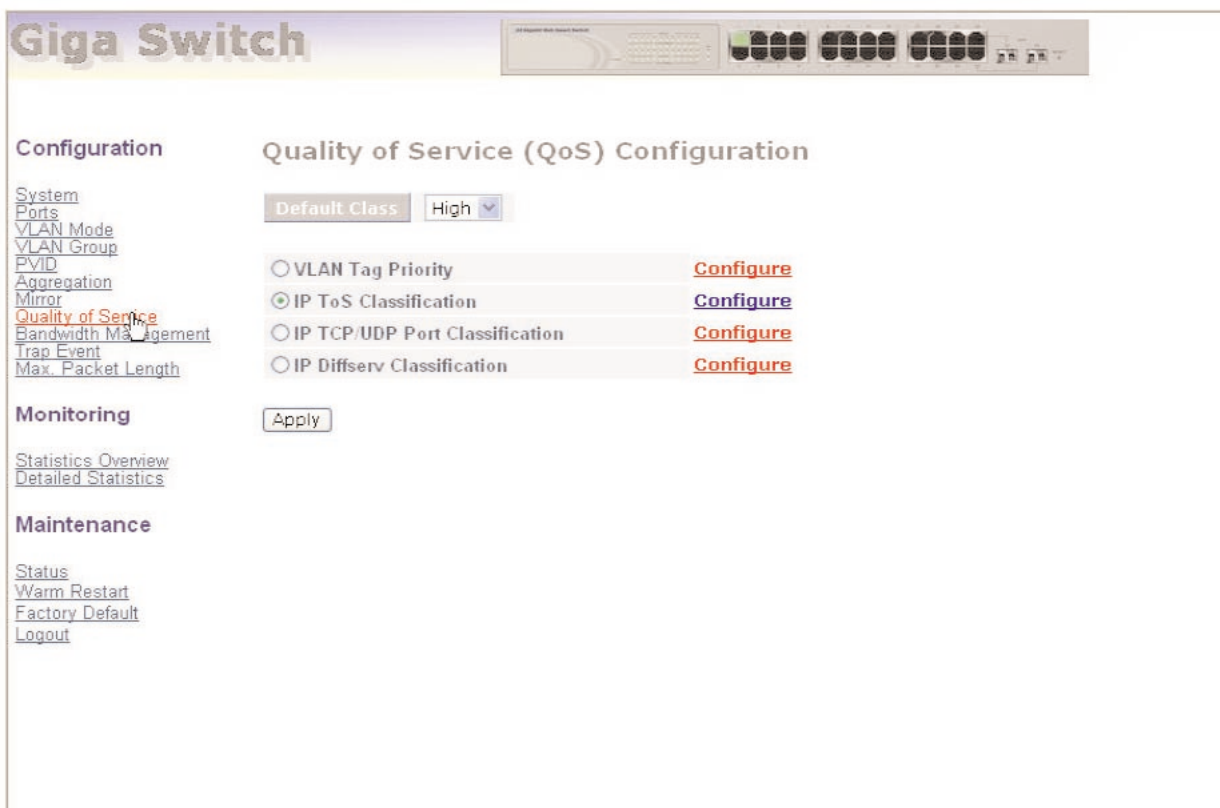

Figure 4-12. Quality of Service Configuration screen.

Table 4-8 describes the options shown in Figure 4-12.

Table 4-8. Quality of Service Configuration screen.

Parameter	Description
Default Class	Select High or Low priority from the drop-down menu. For example, if you set the QoS function as VLAN Tag Priority mode, and choose Default Class as High, then packets with no tag will be considered high priority. The initial Default Class value is High.
VLAN Tag Priority	Select this to enable VLAN tagging. Click on Configure to configure this option.
IP ToS Classification	Select this to apply Layer 3 on a network framework. Click on Configure to configure this option.
IP TCP/UDP Port Classification	Select this, then click on Configure to set L4 QoS configuration.
IP Diffserv Classification	This option is not currently used.
Apply button	Click on this button to save your changes.

VLAN Tag Priority (see Figure 4-12)

When you click on **VLAN Tag Priority**, then **Configure** in Figure 4-12, Figure 4-13 appears.

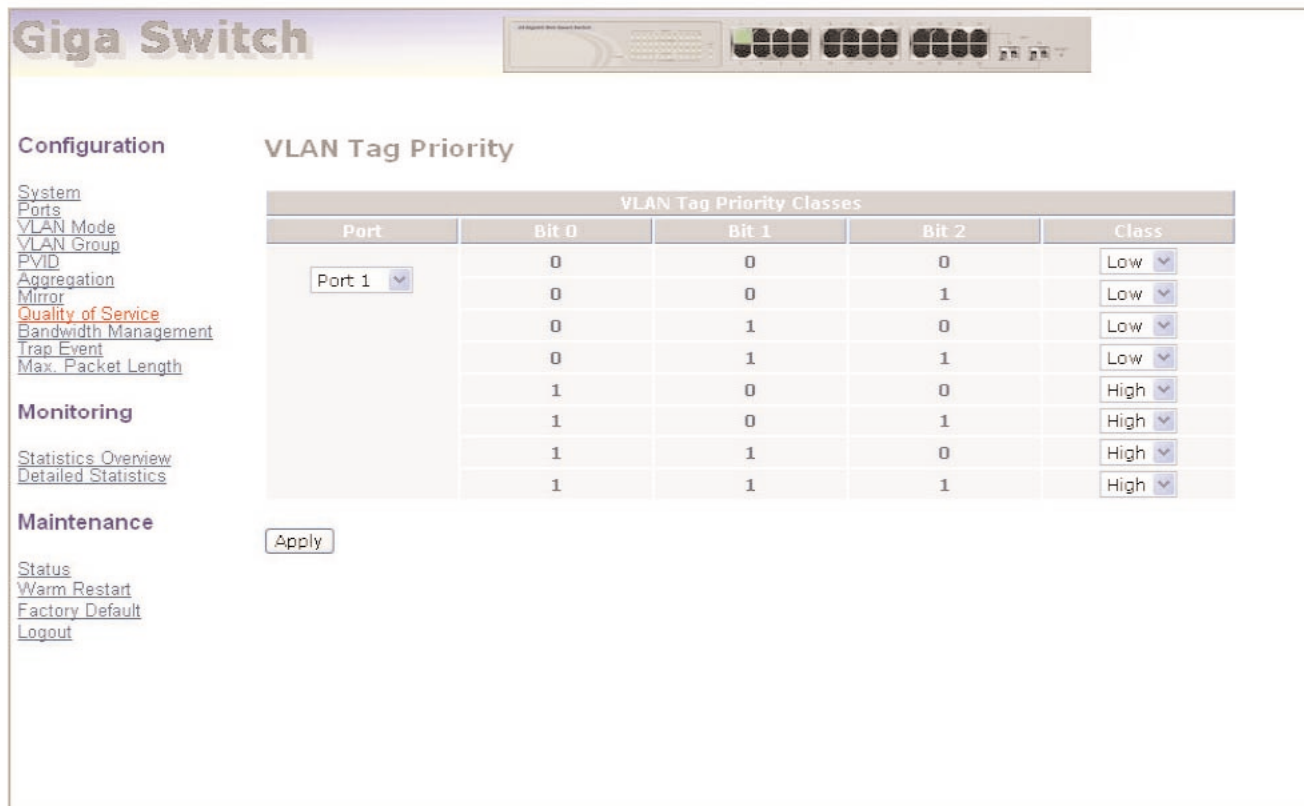

Figure 4-13. VLAN Tag Priority screen.

Table 4-9 describes the options shown in Figure 4-13.

Table 4-9. VLAN Tag Priority screen options.

Parameter	Description
Port	Choose VLAN Tag QoS for ports 1–24 from the drop-down menu. Click on All to set up all ports at once.
Bits	Values can be Bit 0, 1, or 2.
Class	Select High or Low priority from the drop-down menu.
Apply button	Click on this button to save your changes.

MANAGED 24-PORT 10/100/1000 ETHERNET SWITCH WITH 2 SFP DUAL MEDIA

IP ToS Classification (see Figure 4-12)

Another QoS function is applying Layer 3 on a network framework. See Figure 4-14. To get to the screen shown in Figure 4-14, click on **IP ToS Classification** in Figure 4-12. Then click on **Configure**.

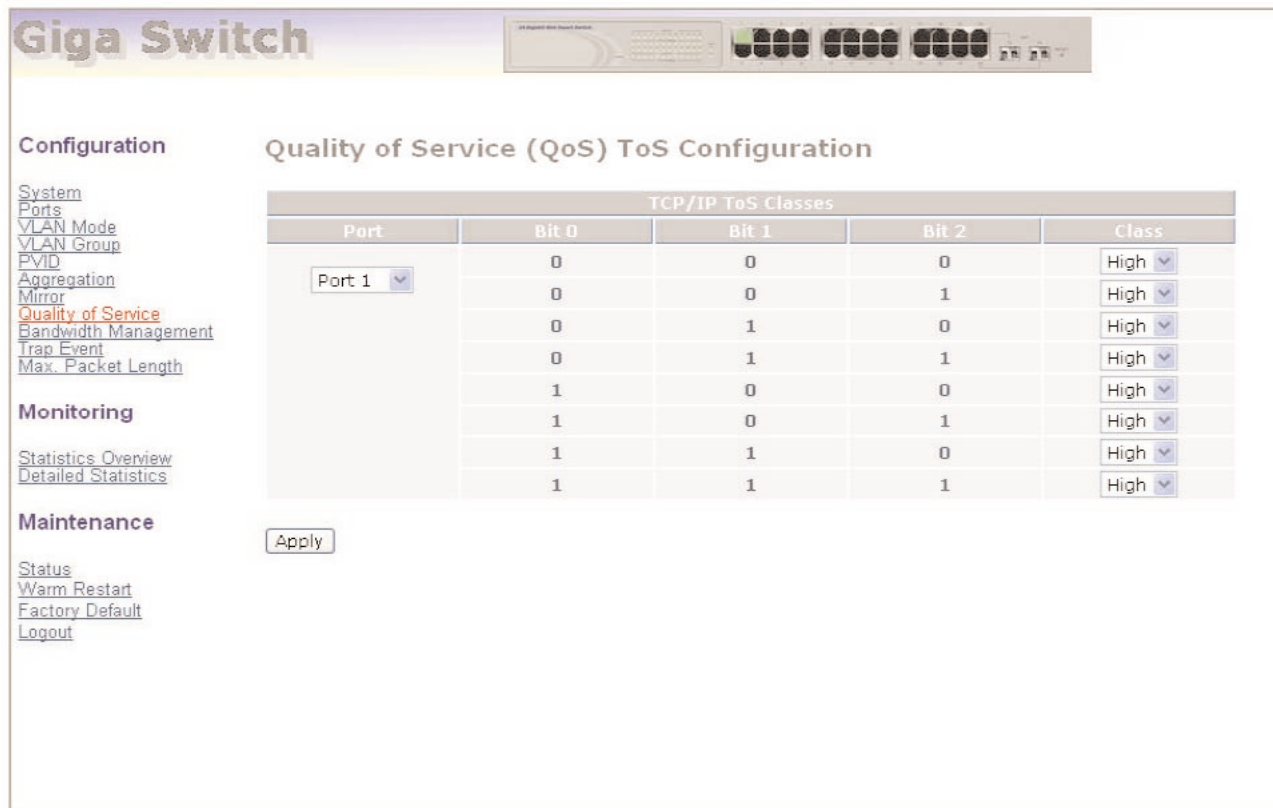

Figure 4-14. QoS ToS Configuration screen.

Table 4-10 describes the options shown in Figure 4-14.

Table 4-10. QoS ToS Configuration screen options.

Parameter	Description
Port	Select ports 1–24 from the drop-down menu. Or choose All to select all ports.
Bits	Displays Bit 0, 1, or 2.
Class	Choose High or Low from the drop-down menu.
Apply button	Click on this button to save your changes.

*IP TCP/UDP Port Classification (see Figure 4-12)**Simple Mode*

This option in Figure 4-12 lets you configure L4 QoS. See Figures 4-15 and 4-16. To get to Figure 4-15, click on **IP TCP/UDP Port Classification** in the Quality of Service (QoS) screen (Figure 4-12). Then click on **Configure**.

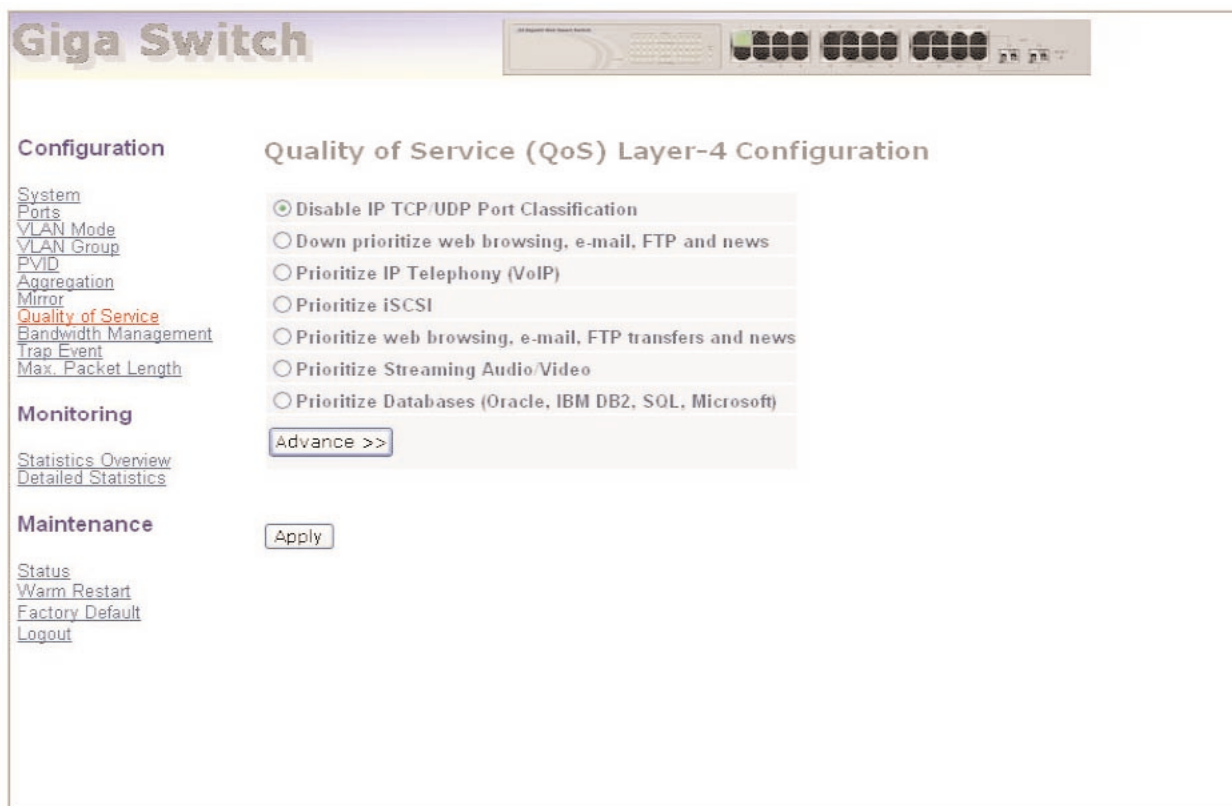

Figure 4-15. Simple Mode screen.

For a description of the parameters shown in Figure 4-15, see Table 4-11.

Advanced Mode

To get to the Advanced mode screen (Figure 4-16), click on **Advance** in Figure 4-15. To go back to the Simple Mode screen (Figure 4-15), click on **Simple** in Figure 4-16.

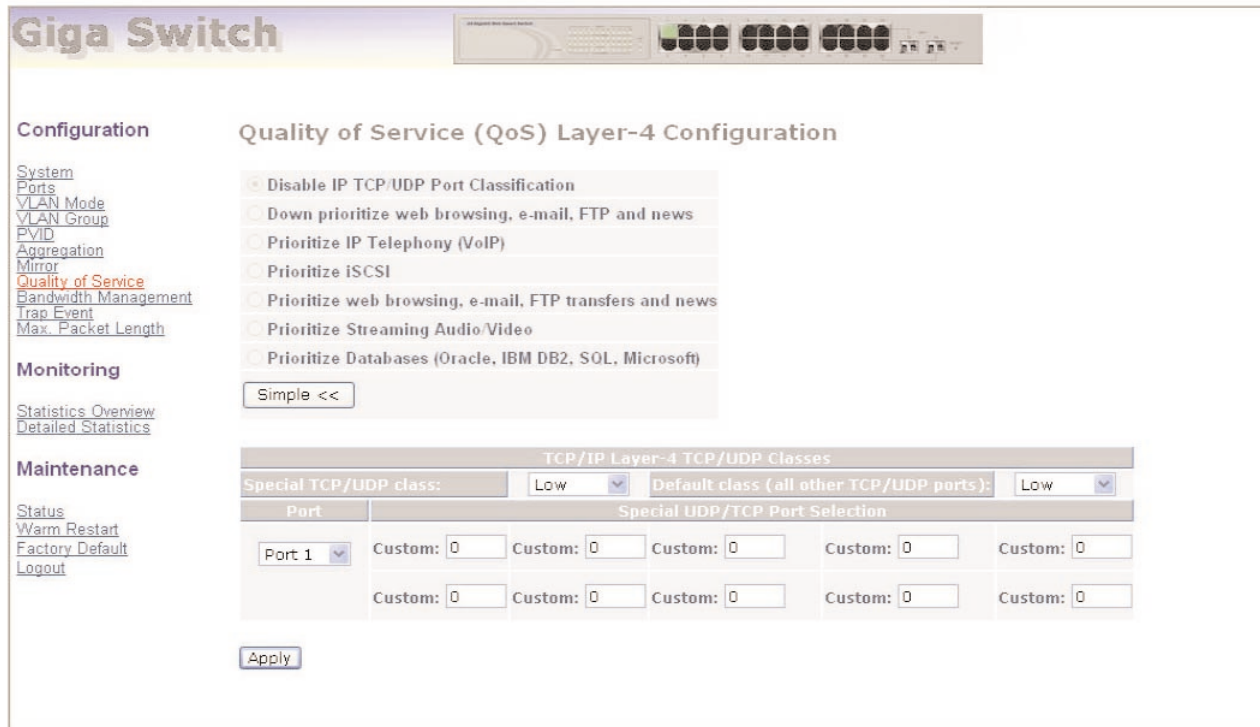

Figure 4-16. Advanced Mode screen.

Table 4-11 describes the options shown in Figures 4-15 and 4-16.

Table 4-11. Advanced or Simple Mode parameters.

Parameter	Description
Disable IP TCP/UDP Port Classification	Click on this button to enable.
Down prioritize Web browsing, e-mail, FTP, and news	Click on this button to enable.
Prioritize IP telephony (VoIP)	Click on this button to enable.
Prioritize iSCSI	Click on this button to enable.
Prioritize Web browsing, e-mail, FTP transfers, and news	Click on this button to enable.
Prioritize Streaming Audio/Video	Click on this button to enable.
Prioritize Databases (Oracle, IBM®, DB2®, SQL, Microsoft®)	Click on this button to enable.

Table 4-11 (continued). Advanced or Simple Mode parameters.

Parameter	Description
Advance or Simple buttons	Click on this button to go to the Advanced or Simple Mode screen.
Apply button	Click on this button to Apply the selections.

In Advanced mode, some additional options are available. Refer to the bottom portion of the screen shown in Figure 4-16 and see Table 4-12.

Table 4-12. Advanced Mode Only parameters.

Parameter	Description
Special TCP/UDP class	Select Low or High priority from the drop-down menu.
Default class (all other TCP/UDP ports)	Select Low or High priority from the drop-down menu.
Port	From the drop-down menu, select port 1–24 to enable the special function to work on the selected ports. Select the All option to set up all ports at the same time.
Custom	Type in the number of the Special TCP/UDP port you want to select.
Apply button	Click on this button to apply the selections.

If you click on the **Simple** button in Figure 4-16, you'll return to the screen shown in Figure 4-15 and all L4 port numbers will disappear.

IP Diffserv Classification (see Figure 4-12)

This option is not currently used.

4.2.9 BANDWIDTH MANAGEMENT

The Bandwidth Management function is used to set up the limit of Ingress and Egress bandwidth for each port.

NOTE

Each switch port owns 16 KB packet buffer. The packet buffer size will be reduced when the bandwidth rate limitation is enabled, which may cause a frame to not be forwarded.

Figure 4-17 shows the Bandwidth Management Configuration. To get to this screen, click on **Bandwidth Management** in the Configuration menu on the Home screen.

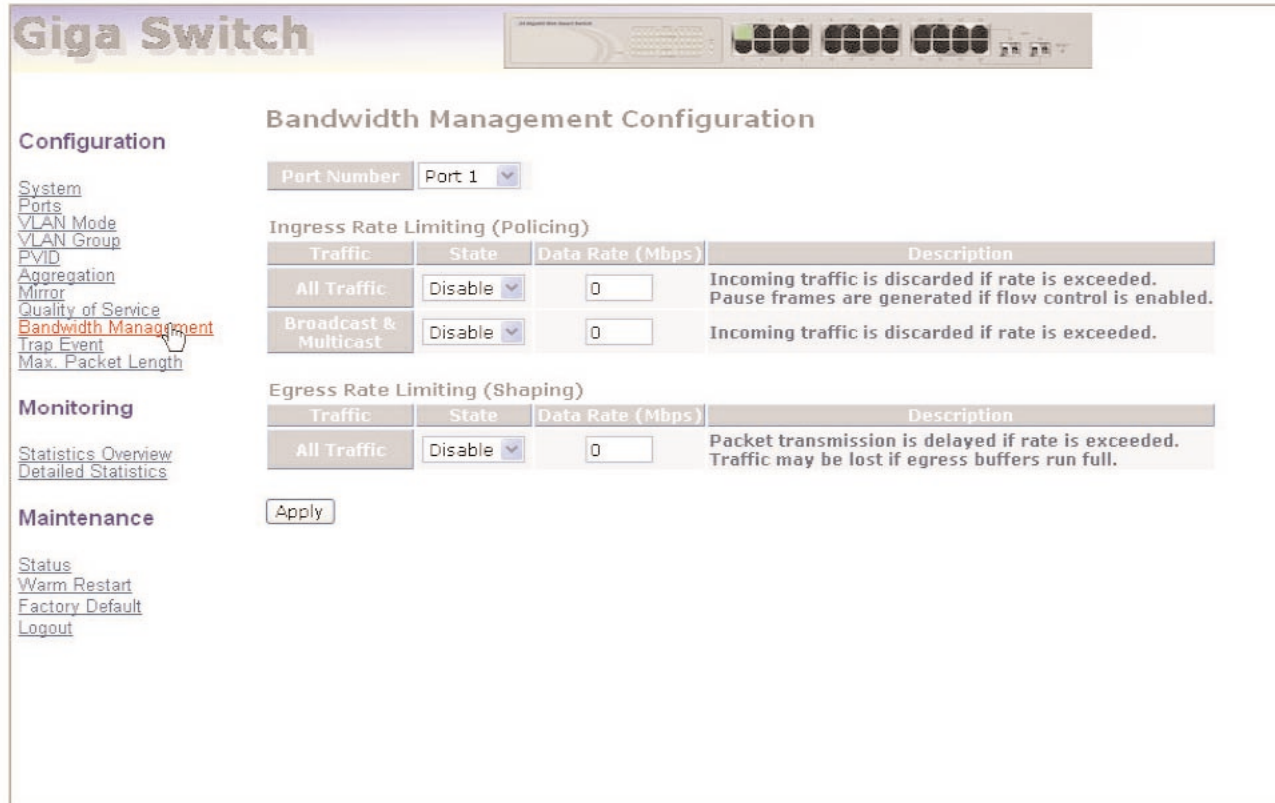

Figure 4-17. Bandwidth Management Configuration screen.

Table 4-13 describes the options shown in Figure 4-17.

Table 4-13. Bandwidth Management Configuration screen options.

Parameter	Description
Port Number	From the drop-down menu, choose the port that you would like this function to work on. Valid options are 1–24. To set up all ports at one time, select All from the drop-down menu.
All Traffic for Ingress Rate Limiting	Set up the limit of Ingress bandwidth for the port you choose. Incoming traffic will be discarded if the rate exceeds the value you set in the Data Rate field. If flow control is enabled, pause frames are also generated.
All Traffic, State	Select Disable or Enable from the drop-down menu.
All Traffic, Data Rate (Mbps)	Type in a number from 0 to 1000 to represent the data rate in Mbps.

Table 4-13 (continued). Bandwidth management options.

Parameter	Description
Broadcast & Multicast for Ingress Rate Limiting	<p>Set up the limit of Ingress bandwidth for the port you choose. Incoming traffic will be discarded if the rate exceeds the value you set up in the Data Rate field.</p> <p>Choose Enable or Disable from the drop-down menu for the State. Type in a number from 0 to 1000 in the Data Rate box to represent the data rate in Mbps.</p>
All Traffic for Egress Rate Limiting	<p>Set up the limit of Egress bandwidth for the port you chose in the Port Number field at the top of the screen. Packet transmission will be delayed if the rate exceeds the value you type (a number from 0 to 1000) in the Data Rate field. Traffic may be lost if the Egress buffers are full.</p> <p>Select Enable or Disable from the drop-down menu for the State.</p> <p>Type in a number from 0 to 1000 in the Data Rate box to represent the data rate in Mbps.</p>
Apply button	Click on this button to save the selections.

4.2.10 TRAP EVENT

The Trap Events Configuration screen is used to enable the switch to send out the trap information while pre-defined trap events occur. To get to this screen, click on **Trap Event** in the Configuration menu shown in the Home screen. See Figure 4-18.

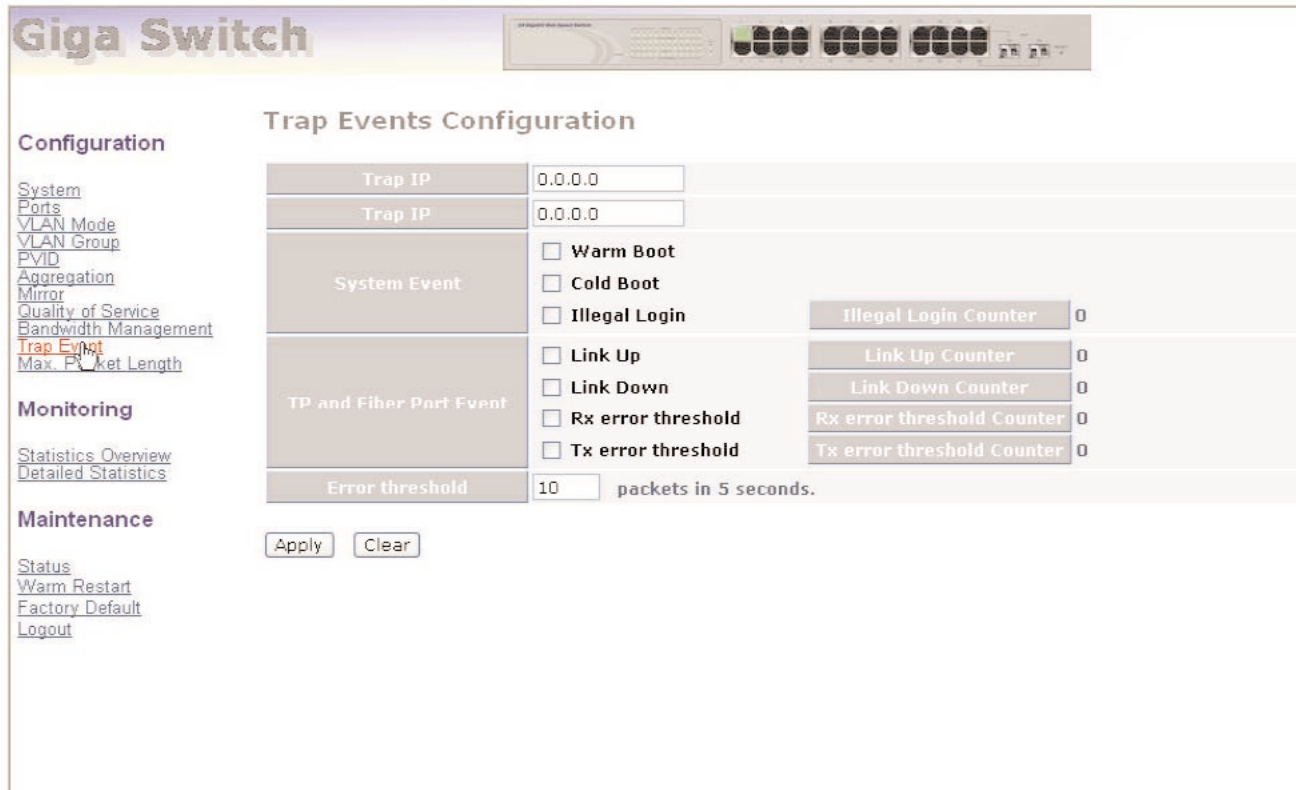

Figure 4-18. Trap Events Configuration screen.

Table 4-14 describes the parameters shown in Figure 4-18.

Table 4-14. Trap Events Configuration screen parameters.

Parameter	Description
Trap IP	This is the IP address of the device that you want to collect data from. Two different device addresses can be selected. “Trap” means to collect data from the specified IP address.
System Event	<p>Warm Boot, Cold Boot, or Illegal Login.</p> <p>Check the Warm Boot box to start a warm boot.</p> <p>Check the Cold Boot box to start a cold boot.</p> <p>Check Illegal Login box to indicate an illegal login.</p> <p>The Illegal Login Counter lists the number of illegal logins.</p>

Table 4-14 (continued). Trap Events Configuration screen parameters.

Parameter	Description
TP and Fiber Port Event	<p>Link Up, Link Down, Rx error threshold, Tx error threshold</p> <p>Check the Link Up box to indicate a link up.</p> <p>Link Up Counter lists the number of link ups.</p> <p>Check the Link Down box to indicate a link down.</p> <p>Link Down Counter lists the number of link downs.</p> <p>Check the Rx error threshold box to indicate an Rx error threshold.</p> <p>Rx error threshold counter lists the number of Rx error thresholds.</p> <p>Check the Tx error threshold box to indicate a Tx error threshold.</p> <p>Tx error threshold counter lists the number of Tx error thresholds.</p>
Error threshold	Lists the number of packets in 5 seconds.
Apply button	Click on this button to save the changes.
Clear button	Click on this button to clear the changes.

MANAGED 24-PORT 10/100/1000 ETHERNET SWITCH WITH 2 SFP DUAL MEDIA

4.2.11 MAXIMUM PACKET LENGTH

Set up the maximum packet length that each switch port can accept. Maximum length can be up to 1532 bytes or 9216 bytes. The default is 1532 bytes. To get to the screen shown in Figure 4-19, click on **Max. Packet Length** in the Configuration menu in the Home screen.

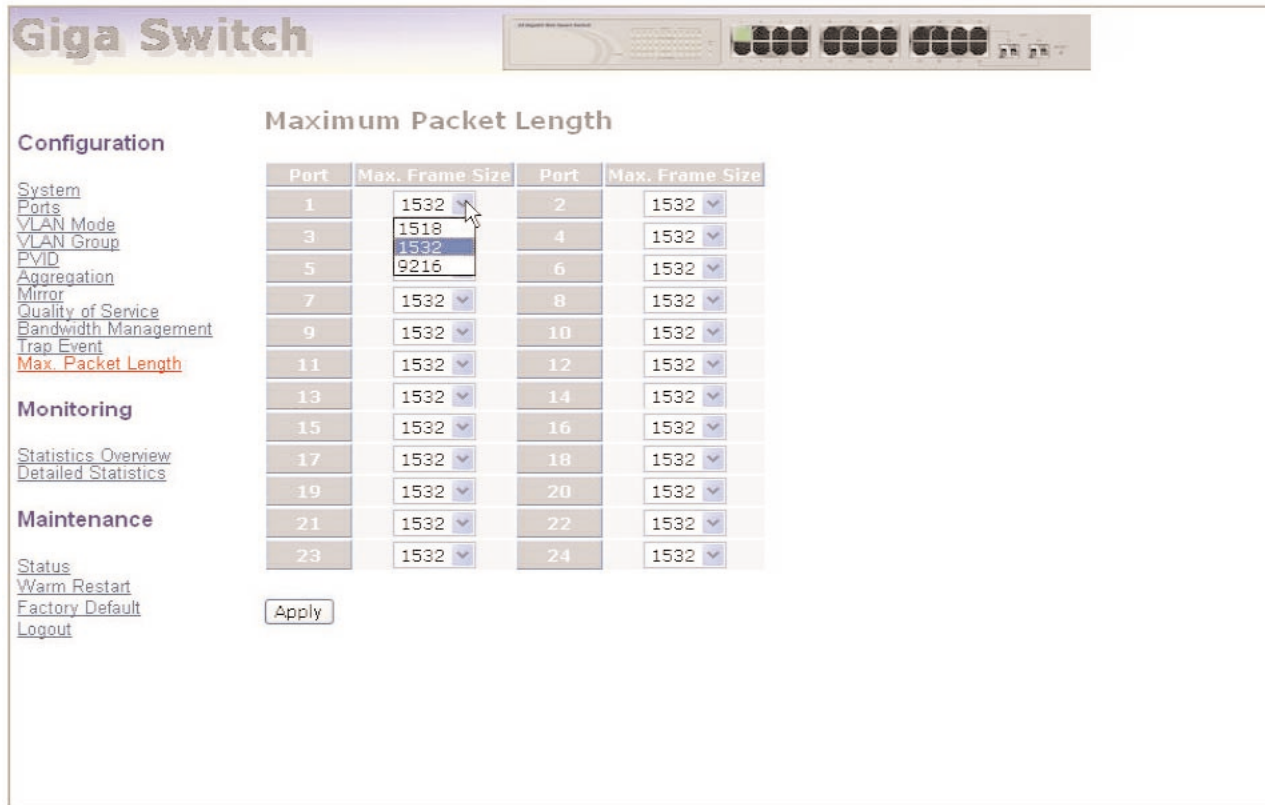

Figure 4-19. Maximum Packet Length screen.

Table 4-15 lists the options shown in Figure 4-19.

Table 4-15. Maximum Packet Length screen options.

Parameter	Description
Port	Lists ports from 1 to 24.
Max. Frame Size	From the drop-down menu, choose 1532 or 9216 bytes.
Apply button	Click on this button to save your changes.

4.3 Monitoring

Two functions are available in the Monitoring menu shown in the Home page. They include Statistics Overview and Detailed Statistics.

4.3.1 STATISTICS OVERVIEW

This option collects any information and provides the counting summary about the port traffic, good or bad. To get to the screen shown in Figure 4-20, click on **Statistics Overview** in the Monitoring menu in the Home page.

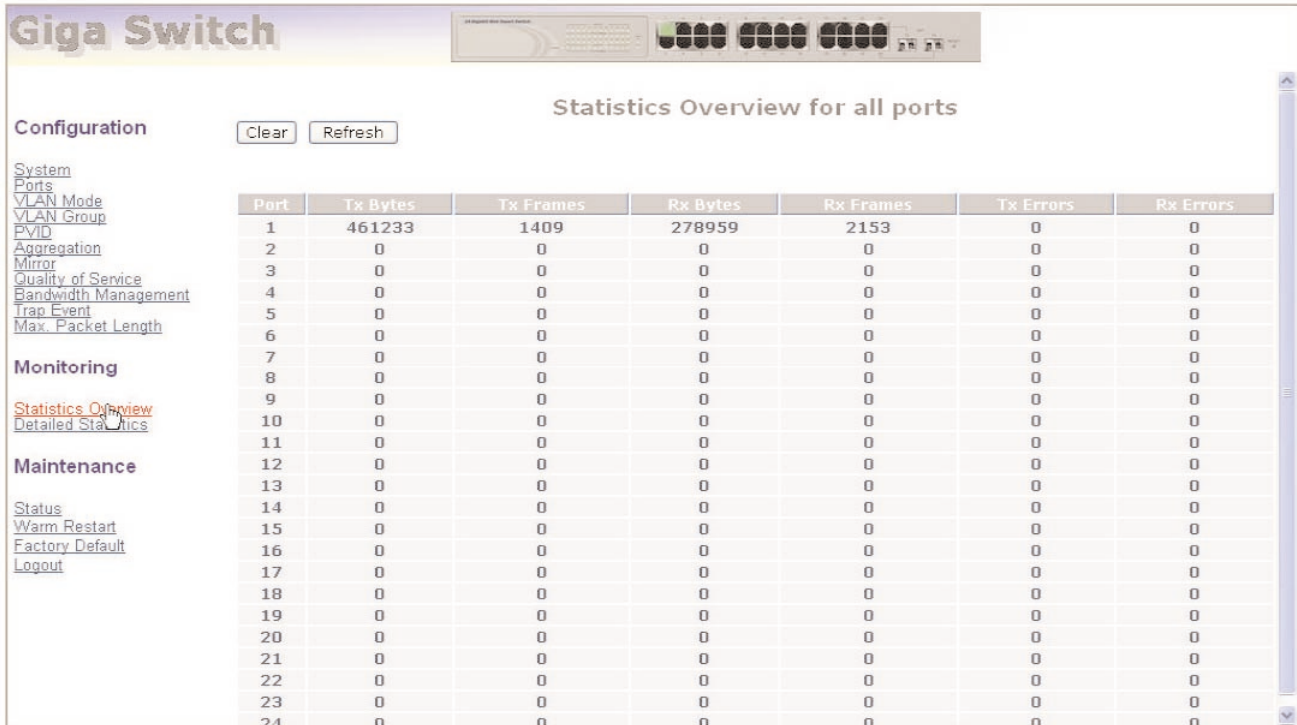

Figure 4-20. Statistics Overview for All Ports screen.

Table 4-16 describes the fields shown in Figure 4-20.

Table 4-16. Statistics Overview options.

Parameter	Description
Port	Lists the port numbers from 1 to 24.
Tx Bytes	Lists the total transmitted bytes.
Tx Frames	Lists how many packets are transmitted.
Rx Bytes	Lists the total received bytes.

MANAGED 24-PORT 10/100/1000 ETHERNET SWITCH WITH 2 SFP DUAL MEDIA

Table 4-16 (continued). Statistics Overview options.

Parameter	Description
Rx Frames	Lists the how many packet are received.
Tx Errors	Lists the number of bad packets transmitted.
Rx Errors	Lists the number of bad packets received.

4.3.2 DETAILED STATISTICS

This screen displays the detailed number for each port's traffic. In Figure 4-21, the window can show all counter information at the same time. To get to this screen, click on **Detailed Statistics** in the Monitoring menu shown in the Home page. Table 4-17 describes the parameters shown in Figure 4-21.



Figure 4-21. Statistics Overview for Specific Ports.

Table 4-17. Statistics Overview for Specific Ports screen parameters.

Parameter	Description
Port	Lists the port numbers from 1 to 24.
Rx Packets	Lists the number of the packets received.
Rx Octets	The total received bytes.

Table 4-17 (continued). Statistics Overview for Specific Ports screen parameters.

Parameter	Description
Rx High Priority Packets	The number of Rx packets classified as high priority.
Rx Low Priority Packets	The number of Rx packets classified as low priority.
Rx Broadcast	Shows the number of the received broadcast packets.
Rx Multicast	Shows the counting number of the received multicast packet.
Tx Packets	Shows the counting number of the packet transmitted.
Tx Octets	The total transmitted bytes.
Tx High Priority Packets	The number of Tx packets classified as high priority.
Tx Low Priority Packets	The number of Tx packets classified as low priority.
Tx Broadcast	Shows the number of the transmitted broadcast packets.
Tx Multicast	Shows the number of the transmitted multicast packets.
Rx 64 Bytes	The number of 64-byte frames in good and bad packets received.
Rx 65–127 Bytes	The number of 65–127-byte frames in good and bad packets received.
Rx 128–255 Bytes	The number of 128–255-byte frames in good and bad packets received.
Rx 256–511 Bytes	The number of 256–511-byte frames in good and bad packets received.
Rx 512–1023 Bytes	The number of 512–1023-byte frames in good and bad packets received.
Rx 1024 Bytes	The number of 1024 maximum-length byte frames in good and bad packets received.
Tx 64 Bytes	The number of 64-byte frames in good and bad packets transmitted.
Tx 65–127 Bytes	The number of 65–127-byte frames in good and bad packets transmitted.
Tx 128–255 Bytes	The number of 128–255-byte frames in good and bad packets transmitted.
Tx 256–511 Bytes	The number of 256–511-byte frames in good and bad packets transmitted.

Table 4-17 (continued). Statistics Overview for Specific Ports screen parameters.

Parameter	Description
Tx 512–1023 Bytes	The number of 512–1023-byte frames in good and bad packets transmitted.
Tx 1024 Bytes	The number of 1024 maximum-length byte frames in good and bad packets transmitted.
Rx CRC/Alignment	The number of alignment errors and CRC error packets received.
Rx Undersize	The number of short frames (<64 bytes) with valid CRC.
Rx Oversize	The number of long frames (according to the maximum length register) with valid CRC.
Rx Fragments	The number of short frames (<64 bytes) with invalid CRC.
Rx Jabber	The number of long frames (according to the maximum length register) with invalid CRC.
Rx Drops	The number of frames dropped due to the lack of a receiving buffer.
Tx Collisions	The number of collisions while transmitting frames.
Tx Drops	The number of frames dropped due to excessive collision, late collision, or frame aging.
Tx FIFO Drops	The number of frames dropped due to the lack of a transmitting buffer.

4.4 Maintenance

Four functions are available in the Maintenance menu: Status, Warm Reset, Factory Default, and Logout.

4.4.1 STATUS

Eight port monitoring and management functions are available in the Status menu; these are listed in italics below and on the next several pages.

System Status

To get to the System Status screen shown in Figure 4-22, click on **Status** in the Maintenance menu shown on the Home page.

System Status

Product Name	24-Port 10/100/1000M Gigabit SW.
Firmware Version	v1.07
Hardware Version	v1.01
Serial Number	030A01000019
IP Address	192.168.1.1
Subnet Mask	255.255.255.0
Default Gateway	192.168.1.254
MAC Address	00-40-c7-e6-00-12
System Name	Giga Switch
Auto Logout Timer (mins)	0

Figure 4-22. System Status screen.

Table 4-18 describes the parameters shown in Figure 4-22.

Table 4-18. System Status parameters.

Parameter	Description
Product Name	Shows the product name of the device.
Firmware Version	Shows the switch's firmware version.
Hardware Version	Shows the switch's hardware version.
Serial Number	The serial number is assigned by the manufacturer.
IP Address	Shows the switch's IP address.
Subnet Mask	Shows the switch's subnet mask.
Default Gateway	Shows the switch's default gateway.
MAC Address	Shows the switch's Ethernet MAC address.
System Name	Shows the switch's name.
Auto Logout Timer (mins)	Shows the amount of time that the switch will wait before logging out of the Web interface.

MANAGED 24-PORT 10/100/1000 ETHERNET SWITCH WITH 2 SFP DUAL MEDIA

TP/Fiber Ports Status

The TP/Fiber Ports Status function displays the latest updated status of all ports in the switch. It allows you to view the setting, link status, speed, and flow control. To get to the screen shown in Figure 4-23, click on **Status** in the Home screen, then **TP/Fiber Ports Status** in the Status menu.

TP Port Status							
Port	Link Status	Speed	Flow Control	Port	Link Status	Speed	Flow Control
1	100FDX	Auto	Enabled	2	Down	Auto	Enabled
3	Down	Auto	Enabled	4	Down	Auto	Enabled
5	Down	Auto	Enabled	6	Down	Auto	Enabled
7	Down	Auto	Enabled	8	Down	Auto	Enabled
9	Down	Auto	Enabled	10	Down	Auto	Enabled
11	Down	Auto	Enabled	12	Down	Auto	Enabled
13	Down	Auto	Enabled	14	Down	Auto	Enabled
15	Down	Auto	Enabled	16	Down	Auto	Enabled
17	Down	Auto	Enabled	18	Down	Auto	Enabled
19	Down	Auto	Enabled	20	Down	Auto	Enabled
21	Down	Auto	Enabled	22	Down	Auto	Enabled
23	Down	Auto	Enabled	24	Down	Auto	Enabled

Fiber Port Status							
Port	Link Status	Speed	Flow Control	Port	Link Status	Speed	Flow Control
23	Down	Auto	Enabled	24	Down	Auto	Enabled

Figure 4-23. TP/Fiber Ports Status screen.

Table 4-19 describes the parameters shown in Figure 4-23.

Table 4-19. TP/Fiber Ports Status screen parameters.

Parameter	Description
Port	Displays the port number from 1 to 24.
Link Status	Shows if the link on the port is active or not. If the link is connected to a working device, the Link Status will show the current link speed and duplex. If the connection is broken, it will show Down. The hardware on both connected devices determines this. There is no default value.
Speed	Displays the speed and duplex of all ports. Three speeds are supported for twisted-pair media: 10 Mbps, 100 Mbps, and 1000 Mbps. If the media is 1 Gbps fiber, only 1000 Mbps speed is supported. The status of speed/duplex mode is determined by the negotiation of both local port and link partner in auto speed mode or user setting in force mode. The local port has to be preset.
Flow Control	Shows each port's flow control status. There are two types of flow control in Ethernet: backpressure for half-duplex operation and pause flow control (IEEE 802.3x) for full duplex. The switch supports both. The default value is Enabled.

Aggregation

To get to the Aggregation screen shown in Figure 4-24, click on **Status** in the Maintenance menu on the Home screen. Then click on **Aggregation** from the Status menu.

Normal	1,2,3,4,5,6,7,8,9,10,11,12,13,14,15,16,17,18,19,20,21,22,23,24
Group 1	
Group 2	
Group 3	
Group 4	
Group 5	
Group 6	
Group 7	
Group 8	

Figure 4-24. Aggregation screen.

Table 4-20 describes the parameters shown in Figure 4-24.

Table 4-20. Aggregation screen parameters.

Parameter	Description
Normal	Displays the ports that do not join any aggregation trunking group.
Group 1–8	Displays the group members.

VLAN

The VLAN Status screens (Figures 4-25, 4-26, and 4-27) display the status of VLAN mode and VLAN group setting. To get to these screens, click on **Status** in the Maintenance menu in the Home screen, then click on **VLAN Status**.

VLAN			
VLAN Mode Tag Based VLAN			
ID	Description	VID	Member
1	Default	1	1,2,3,4,5,6,7,8,9,10,11,12,13,14,15,16,17,18,19,20,21,22,23,24

Figure 4-25. Tag-Based VLAN.

VLAN

VLAN Mode		
Port Based VLAN		
ID	Description	Member
1	Default	1,2,3,4,5,6,7,8,9,10,11,12,13,14,15,16,17,18,19,20,21,22,23,24

Figure 4-26. Port-Based VLAN.

VLAN

VLAN Mode		
Metro Mode		
ID	Description	Member
1	Default1	1,23,24
2	Default2	2,23,24
3	Default3	3,23,24
4	Default4	4,23,24
5	Default5	5,23,24
6	Default6	6,23,24
7	Default7	7,23,24
8	Default8	8,23,24
9	Default9	9,23,24
10	Default10	10,23,24
11	Default11	11,23,24
12	Default12	12,23,24
13	Default13	13,23,24
14	Default14	14,23,24
15	Default15	15,23,24
16	Default16	16,23,24
17	Default17	17,23,24
18	Default18	18,23,24
19	Default19	19,23,24
20	Default20	20,23,24
21	Default21	21,23,24
22	Default22	22,23,24

Figure 4-27. VLAN Metro Mode screen.

Table 4-21 describes the parameters shown in Figures 4-25, 4-26, and 4-27.

Table 4-21. VLAN screen parameters.

Parameter	Description
VLAN Mode	Tag-based, Port-based, or Metro mode.
VID	1–24
Member	Port numbers from 1 to 24.

Mirror

The Mirror status screen (Figure 4-28) displays the mirror configuration setting result. To get to this screen, click on **Status** in the Maintenance menu in Figure 4-3. Then click on **Mirror** in the Status menu.

Mirror

Sniffer Mode	Disable
Sniffer Port	1
Source Port	

Figure 4-28. Mirror status screen.

Table 4-22 describes the parameters in Figure 4-28.

Table 4-22. Mirror status screen options.

Parameter	Description
Sniffer Mode	Choose to display Disable or Enable.
Sniffer Port	Displays the port number of the selected port (1–24).
Source Port	Displays the port number of the selected port (1–24).

Trap Event

The Trap Event status screen (see Figure 4-29) displays the switch’s trap information sent out while predefined trap events occurred. To get to this screen, click on **Status** in the Maintenance menu in the Home screen, then click on **Trap Event** from the Status menu.

Trap Event

Trap IP	0.0.0.0		
Trap IP	0.0.0.0		
System Event			
Warm Boot	<input type="checkbox"/>		
Cold Boot	<input type="checkbox"/>		
Illegal Login	<input type="checkbox"/>	Illegal Login Counter	0
TP and Fiber Port Event			
Link Up	<input type="checkbox"/>	Link Up Counter	0
Link Down	<input type="checkbox"/>	Link Down Counter	0
Rx error threshold	<input type="checkbox"/>	Rx error threshold Counter	0
Tx error threshold	<input type="checkbox"/>	Tx error threshold Counter	0
Error threshold	10		

Figure 4-29. Trap Event screen.

Table 4-23 describes the parameters shown in Figure 4-29.

Table 4-23. Trap Event screen options.

Parameter	Description
Trap IP	This displays the IP address(es) of the device(s) that you selected to collect data from. “Trap” means to collect data from the specified IP address. One or two Trap IP addresses can be displayed.
Warm Boot	Check this box to select warm boot.
Cold Boot	Check this box to select cold boot.
Illegal Login	Check this box to count the number of illegal logins.
Illegal Login Counter	Displays the number of illegal login attempts.

Table 4-23 (continued). Trap Event screen options.

Parameter	Description
Link Up	Check this box to enable link up.
Link Up Counter	Displays the number of link ups counted.
Link Down	Check this box to enable link down.
Link Down Counter	Displays the number of link downs counted.
Rx error Threshold	Check this box to enable Rx error threshold.
Rx error Threshold Counter	Displays the number of Rx errors counted.
Tx error Threshold	Check this box to enable Tx error threshold.
Tx error Threshold Counter	Displays the number of Tx errors counted.
Error threshold	Displays the number of errors.

Maximum Packet Length

The Maximum Packet Length status screen (see Figure 4-30) displays the settings of the maximum packet length that each switch port can accept. To get to this screen, click on **Status** in the Maintenance menu (Figure 4-3), then click on **Max. Packet Length** in the Status menu.

Port	Max. Frame Size	Port	Max. Frame Size
1	1532	2	1532
3	1532	4	1532
5	1532	6	1532
7	1532	8	1532
9	1532	10	1532
11	1532	12	1532
13	1532	14	1532
15	1532	16	1532
17	1532	18	1532
19	1532	20	1532
21	1532	22	1532
23	1532	24	1532

Figure 4-30. Maximum Packet Length screen.

Table 4-24 explains the options shown in Figure 4-30.

Table 4-24. Maximum Packet Length screen parameters.

Parameter	Description
Port	Lists ports 1–24.
Max. Frame Size	Displays the settings for the maximum size packet length that each switch port can accept. The maximum length can be up to 1532 bytes or 9216 bytes. The default value is 1532 bytes.

4.4.2 WARM RESTART

You can reboot the switch in many ways, including power on, hardware reset, and software reset. Press the **Reset** button on the front panel to reset the switch and to retrieve the default setting. After upgrading the software, you must reboot to have the new configuration take effect.

To get to the Warm Restart screen shown in Figure 4-31, click on **Warm Restart** in the Maintenance menu in the Home screen (Figure 4-3).



Figure 4-31. Warm Restart screen.

To perform a warm reset, press the **Yes** button.

4.4.3 FACTORY DEFAULT

The factory default configuration function can retrieve the default setting to replace the working configuration. Except for the IP address setting, all configurations will be restored to the factory default value when you select Restore Default Configuration from the Factory Default screen. To get to the Restore Default Configuration screen shown in Figure 4-32, click on **Factory Default** in the Maintenance menu on the Home screen. If you want to restore all configurations including the IP address setting to the factory default, press the **Reset** button on the front panel.

NOTE

For the Reset button: You must press and hold the Reset button for at least 3 seconds to restore the factory default setting.

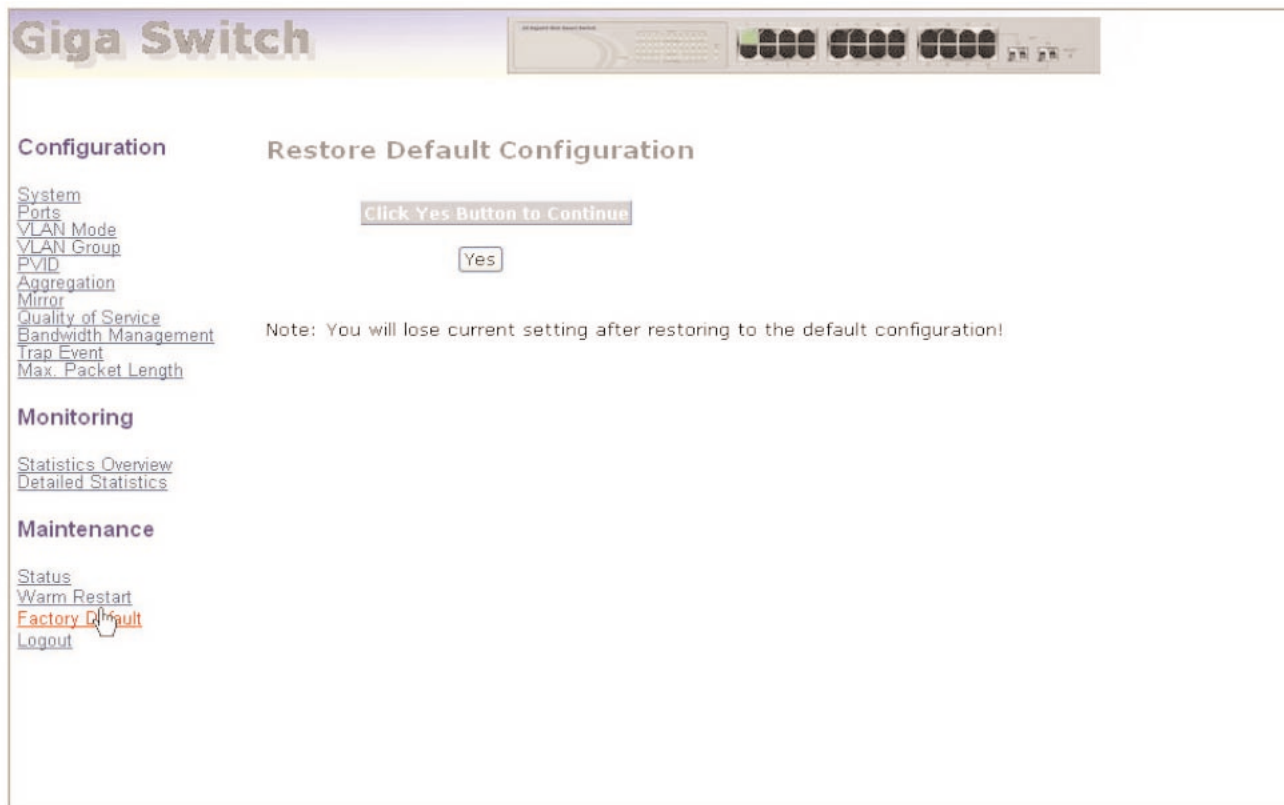

Figure 4-32. Restore Default Configuration screen.

To restore default configuration, press the **Yes** button.

4.4.4 LOGOUT

The switch allows you to log out of the system to prevent unauthorized users from accessing the system. If you do not log out and exit the browser, the switch will automatically log out. Besides the manual logout and implicit logout, you can also set the Auto Logout Timer in the system configuration function to On or Off. To get to the Logout screen shown in Figure 4-33, click on **Logout** in the Maintenance menu in the Home screen.

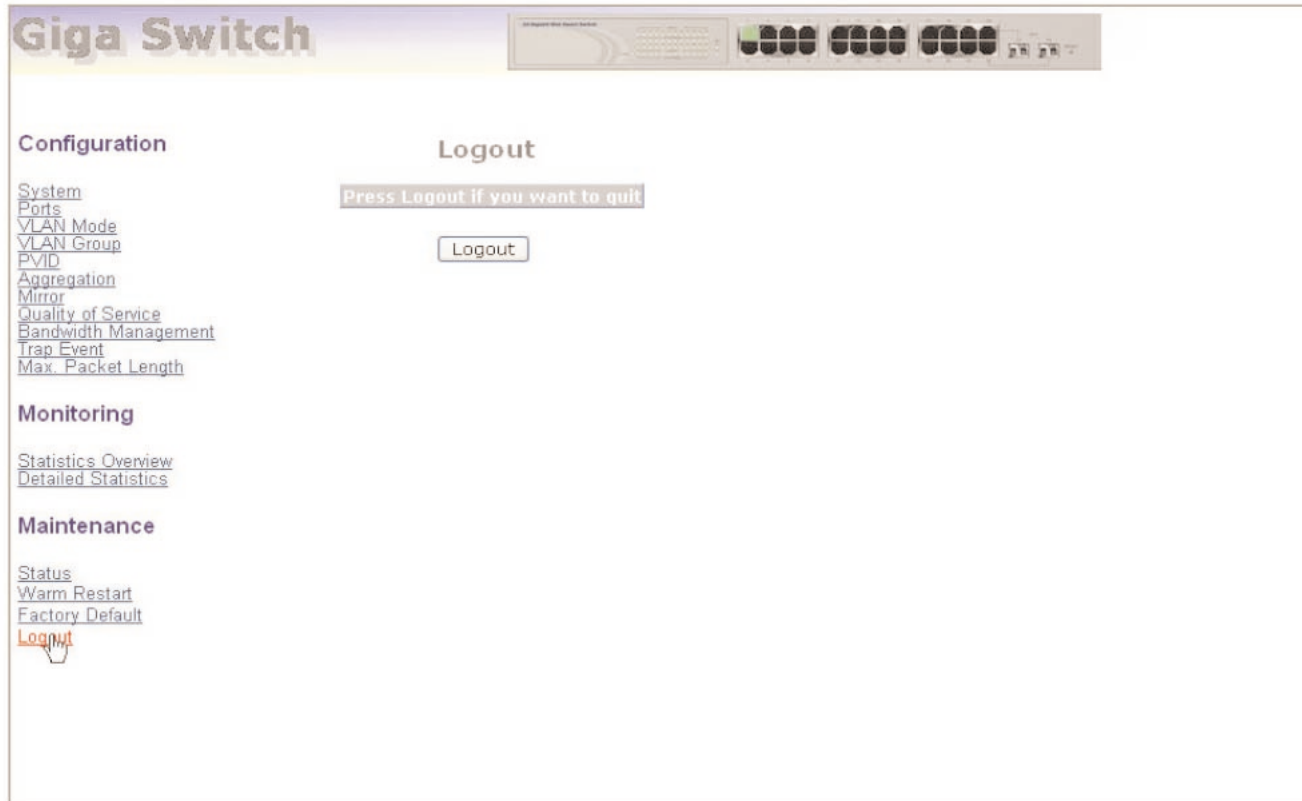

Figure 4-33. Logout screen.

Press the **Logout** button to log out.

5. Troubleshooting

5.1 Problems You May Experience

Problem: The Link/Act LED is off.

Possible Cause #1: The attached device is not powered on.

Possible Solution #1: Power on the attached device.

Possible Cause #2: The cable may not be the correct type or is faulty.

Possible Solution #2: Determine whether the cable is the correct type or if it is faulty. Replace the cable if necessary.

Possible Cause #3: The installed building premise cable is faulty.

Possible Solution #3: Replace the faulty cable.

Possible Cause #4: The port may be faulty.

Possible Solution #4: Attach a device with a known working port.

Problem: Computer A can connect to computer B, but it can't connect to computer C through the Managed 24-Port 10/100/1000 Ethernet Switch with 2 SFP Dual Media.

Possible Cause #1: Check computer C's Link/Act LED.

Possible Solution #1: If the Link/Act LED is off, try another network device on this connection.

Possible Cause #2: Computer C's network link might be incorrectly configured.

Possible Solution #2: Verify the network configuration on computer C.

Problem: The uplink connection function fails to work.

Possible Cause: The ports on another switch must be compatible with the Managed 24-Port 10/100/1000 Ethernet Switch with 2 SFP Dual Media.

Possible Solution: Check the switch's uplink setup to verify that the uplink function is enabled.

Problem: How do I configure the switch?

Possible Solution: Use the Internet Explorer browser program to control the Web functions in the switch. First, choose any port in the Managed 24-Port 10/100/1000 Ethernet Switch with 2 SFP Dual Media. Then, type the default IP address, 192 . 168 . 1 . 1, in the address row in the browser to connect to the switch via an RJ-45 network line. The login screen will appear.

5.2 Calling Black Box

If you determine that your Managed 24-Port 10/100/1000 Ethernet Switch with 2 SFP Dual Media is malfunctioning, do not attempt to alter or repair the unit. It contains no user-serviceable parts. Contact Black Box at 724-746-5500.

Before you do, make a record of the history of the problem. We will be able to provide more efficient and accurate assistance if you have a complete description, including:

- the nature and duration of the problem.
- when the problem occurs.
- the components involved in the problem.
- any particular application that, when used, appears to create the problem or make it worse.

5.3 Shipping and Packaging

If you need to transport or ship your Managed 24-Port 10/100/1000 Ethernet Switch with 2 SFP Dual Media:

- Package it carefully. We recommend that you use the original container.
- If you are shipping the Managed 24-Port 10/100/1000 Ethernet Switch with 2 SFP Dual Media for repair, make sure you include everything that came in the original package. Before you ship, contact Black Box to get a Return Authorization (RA) number.