



© Copyright 2005. Black Box Corporation. All rights reserved.

---

1000 Park Drive • Lawrence, PA 15055-1018 • 724-746-5500 • Fax 724-746-0746



## 2- and 4-Port ServSwitch— DT Pro with Audio

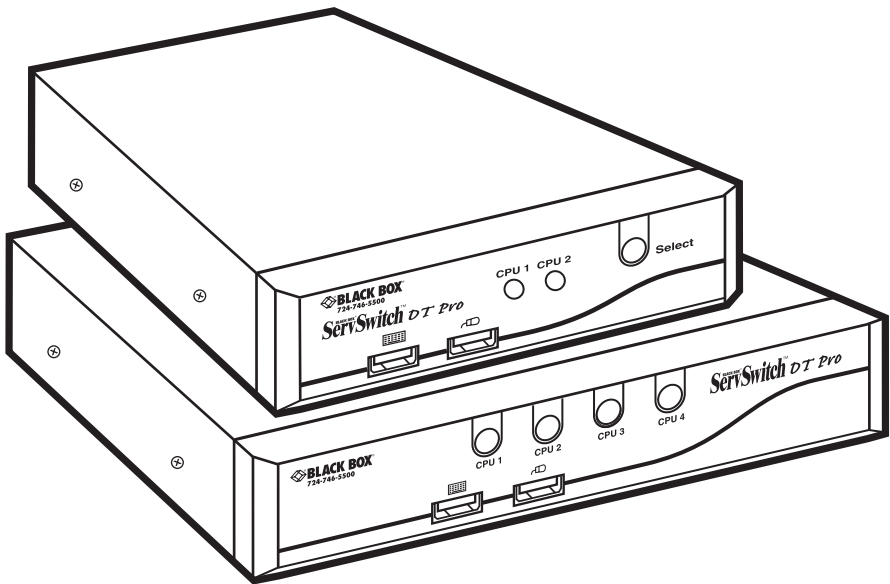

**CUSTOMER  
SUPPORT  
INFORMATION**

Order toll-free in the U.S.: Call **877-877-BBOX** (outside U.S. call **724-746-5500**)  
FREE technical support 24 hours a day, 7 days a week: Call **724-746-5500** or fax **724-746-0746**  
Mailing address: **Black Box Corporation**, 1000 Park Drive, Lawrence, PA 15055-1018  
Web site: [www.blackbox.com](http://www.blackbox.com) • E-mail: [info@blackbox.com](mailto:info@blackbox.com)



**FEDERAL COMMUNICATIONS COMMISSION  
and INDUSTRY CANADA  
RADIO FREQUENCY INTERFERENCE STATEMENTS**

**Class B Digital Device.** This equipment has been tested and found to comply with the limits for a Class B computing device pursuant to Part 15 of the FCC Rules. These limits are designed to provide reasonable protection against harmful interference in a residential installation. However, there is no guarantee that interference will not occur in a particular installation. This equipment generates, uses, and can radiate radio frequency energy, and, if not installed and used in accordance with the instructions, may cause harmful interference to radio communications. If this equipment does cause harmful interference to radio or telephone reception, which can be determined by turning the equipment off and on, the user is encouraged to try to correct the interference by one of the following measures:

- Reorient or relocate the receiving antenna.
- Increase the separation between the equipment and receiver.
- Connect the equipment into an outlet on a circuit different from that to which the receiver is connected.
- Consult an experienced radio/TV technician for help.

### **CAUTION**

**Changes or modifications not expressly approved by the party responsible for compliance could void the user's authority to operate the equipment.**

To meet FCC requirements, shielded cables and power cords are required to connect this device to a personal computer or other Class B certified device.

*This digital apparatus does not exceed the Class B limits for radio noise emission from digital apparatus set out in the Radio Interference Regulation of Industry Canada.*

*Le présent appareil numérique n'émet pas de bruits radioélectriques dépassant les limites applicables aux appareils numériques de classe B prescrites dans le Règlement sur le brouillage radioélectrique publié par Industrie Canada.*

### NORMAS OFICIALES MEXICANAS (NOM) ELECTRICAL SAFETY STATEMENT

#### INSTRUCCIONES DE SEGURIDAD

1. Todas las instrucciones de seguridad y operación deberán ser leídas antes de que el aparato eléctrico sea operado.
2. Las instrucciones de seguridad y operación deberán ser guardadas para referencia futura.
3. Todas las advertencias en el aparato eléctrico y en sus instrucciones de operación deben ser respetadas.
4. Todas las instrucciones de operación y uso deben ser seguidas.
5. El aparato eléctrico no deberá ser usado cerca del agua—por ejemplo, cerca de la tina de baño, lavabo, sótano mojado o cerca de una alberca, etc..
6. El aparato eléctrico debe ser usado únicamente con carritos o pedestales que sean recomendados por el fabricante.
7. El aparato eléctrico debe ser montado a la pared o al techo sólo como sea recomendado por el fabricante.
8. Servicio—El usuario no debe intentar dar servicio al equipo eléctrico más allá a lo descrito en las instrucciones de operación. Todo otro servicio deberá ser referido a personal de servicio calificado.
9. El aparato eléctrico debe ser situado de tal manera que su posición no interfiera su uso. La colocación del aparato eléctrico sobre una cama, sofá, alfombra o superficie similar puede bloquea la ventilación, no se debe colocar en libreros o gabinetes que impidan el flujo de aire por los orificios de ventilación.
10. El equipo eléctrico deber ser situado fuera del alcance de fuentes de calor como radiadores, registros de calor, estufas u otros aparatos (incluyendo amplificadores) que producen calor.
11. El aparato eléctrico deberá ser conectado a una fuente de poder sólo del tipo descrito en el instructivo de operación, o como se indique en el aparato.

12. Precaución debe ser tomada de tal manera que la tierra física y la polarización del equipo no sea eliminada.
13. Los cables de la fuente de poder deben ser guiados de tal manera que no sean pisados ni pellizcados por objetos colocados sobre o contra ellos, poniendo particular atención a los contactos y receptáculos donde salen del aparato.
14. El equipo eléctrico debe ser limpiado únicamente de acuerdo a las recomendaciones del fabricante.
15. En caso de existir, una antena externa deberá ser localizada lejos de las líneas de energía.
16. El cable de corriente deberá ser desconectado del cuando el equipo no sea usado por un largo periodo de tiempo.
17. Cuidado debe ser tomado de tal manera que objetos líquidos no sean derramados sobre la cubierta u orificios de ventilación.
18. Servicio por personal calificado deberá ser provisto cuando:
  - A: El cable de poder o el contacto ha sido dañado; u
  - B: Objetos han caído o líquido ha sido derramado dentro del aparato; o
  - C: El aparato ha sido expuesto a la lluvia; o
  - D: El aparato parece no operar normalmente o muestra un cambio en su desempeño; o
  - E: El aparato ha sido tirado o su cubierta ha sido dañada.

## 2- AND 4-PORT SERVSCHWITCH—DT PRO WITH AUDIO

### TRADEMARKS USED IN THIS MANUAL

BLACK BOX and the Double Diamond logo are registered trademarks, and ServSwitch is a trademark, of BB Technologies, Inc.

IntelliMouse, Microsoft, and Windows are either registered trademarks or trademarks of Microsoft Corporation in the United States and/or other countries.

*Any other trademarks mentioned in this manual are acknowledged to be the property of the trademark owners.*

# Contents

Chapter	Page
1. Specifications . . . . .	6
2. Overview . . . . .	7
2.1 Introduction . . . . .	7
2.2 Components . . . . .	8
2.2.1 Front Panel . . . . .	8
2.2.2 Rear Panel . . . . .	9
2.3 What's Included . . . . .	10
2.4 What You'll Need to Supply . . . . .	10
3. Installation . . . . .	11
3.1 ServSwitch Placement . . . . .	11
3.2 Hardware Installation . . . . .	11
3.2.1 Connecting the Console . . . . .	11
3.2.2 Powering On the ServSwitch . . . . .	14
3.2.3 Connecting the Computers . . . . .	14
4. Operation . . . . .	16
4.1 Powering Up the System . . . . .	16
4.2 Selecting Computers Using Front-Panel Buttons . . . . .	16
4.3 Selecting Computers Using Keyboard Hotkey Commands . . . . .	16
4.3.1 Selecting USB Devices Connected to the 2- and 4-Port USB 2.0 Hub . . . . .	17
4.3.2 Switching USB Devices Only . . . . .	18
4.3.3 Switching to Another Computer But Allowing USB Devices to Remain on the Current Port . . . . .	18
4.3.4 Switching Computers and USB Devices . . . . .	18
4.3.5 AutoScan . . . . .	19
4.3.6 Flash Upgrade . . . . .	19
Appendix. Troubleshooting . . . . .	20
A.1 Calling Black Box . . . . .	20
A.2 Shipping and Packaging . . . . .	20



# 1. Specifications

**Resolution:** 2048 x 1536 @ 85 Hz

**Supported Operating Systems:** Windows® 98 SE/Me/2000/XP

**Hotkeys:** Yes

**User Controls:** KV7010A: (1) port selection button;

KV7011A: (4) port selection buttons

**Connectors:** KV7010A: Computer end: (2) USB 2.0 peripherals,

Monitor: (2) HD15 female,

Audio (speakers)/microphone: (4) 3.5-mm jacks;

Flash: (1) 8-pin mini-DIN;

Console end: Keyboard and mouse: (2) USB 2.0,

Monitor: (1) HD15 female,

Audio (speakers)/microphone: (2) 3.5-mm jacks;

KV7011A: Computer end: (2) USB 2.0 peripherals,

Monitor: (4) HD15 female,

Audio (speakers)/microphone: (8) 3.5-mm jacks;

Flash: (1) 8-pin mini-DIN;

Console end: Keyboard and mouse: (2) USB 2.0

Monitor: (1) HD15 female,

Audio (speakers)/microphone: (2) 3.5-mm jacks

**Indicators:** KV7010A: (2) Port LEDs;

KV7011A: (4) Port LEDs

**Temperature Tolerance:** Operating: 32 to 104°F (0 to 40°C);

Storage: -4 to +140°F (-20 to +60°C)

**Relative Humidity:** Up to 80%, noncondensing

**Power:** 5-VDC, 2.5-A power supply, specific to your country, ordered separately

**Size:** KV7010A: 1.8"H x 5.4"W x 5.1"D (4.6 x 13.7 x 13 cm);

KV7011A: 1.8"H x 8.3"W x 5.3"D (4.6 x 21.1 x 13.5 cm)

**Weight:** KV7010A: 1.8 lb. (0.8 kg);

KV7011A: 2.2 lb. (1 kg)

## 2. Overview

### 2.1 Introduction

The 2- or 4-Port ServSwitch™—DT Pro with Audio allows you to control up to two or four USB computers from a single USB console (USB keyboard, USB mouse, and monitor). Supported mice include Microsoft® IntelliMouse® and other mice.

Designed for the latest multimedia environments, the ServSwitch supports audio and includes built-in microphone and speaker jacks. Use one microphone for audio input and listen to each computer's audio output on one set of speakers (on a one-computer-at-a-time basis).

This compact and portable ServSwitch is compatible with USB Type 1.1 or 2.0 devices. The switch also has a built-in USB Version 2.0 hub. This hub allows you to connect additional shared peripherals on a one-computer-at-a-time basis. Using a hotkey command sequence (see **Section 4.3.3**), you can asynchronously switch the KVM control and the USB devices. And the ServSwitch works with common operating systems, including Windows 98 SE/Me/2000/XP. Flash-upgradable firmware allows you to obtain the latest firmware upgrades.

Setup is fast and simple, and there's no software to configure. Its small desktop footprint is ideal for on or under your desktop. Use either front-panel buttons on the ServSwitch or hotkeys on your keyboard to select ports or start AutoScan. The front-panel buttons include integral LEDs. The LED will light with the corresponding active port when manually switching between the computers. The ServSwitch beeps to confirm that it's in hotkey mode. The AutoScan function allows you to automatically scan and monitor all computers, one by one, that are connected to the ServSwitch.

The ServSwitch supports video resolutions of up to 2048 x 1536 @ 85 Hz.

## 2.2 Components

### 2.2.1 FRONT PANEL

Figure 2-1 shows the 2- and 4-Port ServSwitch front views. Table 2-1 describes the components numbered in the illustration.

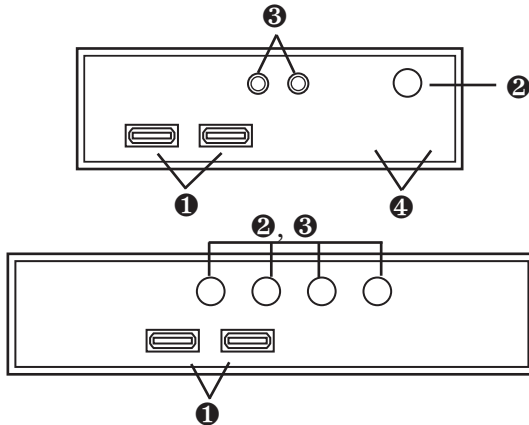

Figure 2-1. The ServSwitch front-panel views.

Table 2-1. Front-panel components.

Component	Description
① Console USB ports	USB keyboard and mouse ports.
② Direct-access port buttons	Press to select a computer.
③ Port LEDs	<p>Integral LEDs on the port buttons are red when the connected computer is powered and running.</p> <p>The LEDs are green when the connected computer is selected.</p> <p>The LEDs flash when the connected computer is running AutoScan.</p>

**2.2.2 REAR PANEL**

Figure 2-2 shows the 4-Port ServSwitch rear view. Table 2-2 describes the components numbered in the illustration.

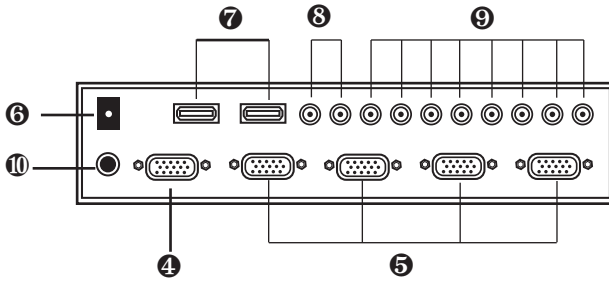

**Figure 2-2. The 4-Port ServSwitch back-panel view.**

**Table 2-2. Rear-panel components.**

<b>Component</b>	<b>Description</b>
<b>4</b> Console VGA port	Attaches to the user monitor.
<b>5</b> Computer VGA ports	Connect to a computer's video cards.
<b>6</b> Power connector	Connects to a 5-VDC, 2.5-A power supply (ordered separately).
<b>7</b> USB 2.0 input ports	Connect to up to two peripherals (USB flash drive, printers, etc.).
<b>8</b> Console audio/microphone jacks	Connect to the consoles' audio (speakers) (green) and microphone (pink).
<b>9</b> Computer audio/microphone jacks	Connect to the computer's audio (speakers). (green) and microphone (pink).
<b>10</b> Flash upgrade port 8-pin mini-DIN	Attach a flash upgrade cable to this port.

### 2.3 What's Included

The package should contain the following items. If anything is missing or damaged, please contact Black Box.

- (1) 2- or 4-Port ServSwitch—DT Pro with Audio
- (1) Flash cable
- This user's manual

### 2.4 What You'll Need to Supply

- ServSwitch—DT Pro with Audio Cables (EHN7001011, 6-, 9-, or 15-foot [1.8-, 2.7-, or 4.5-m] long): These cables connect to computers that have one HD15 connector, one USB connector, and two audio connectors.
- Power supply that's specific to your country: United States (PS71013-US), Japan (PS71013-JP), Europe (PS71013-EU), United Kingdom (PS71013-UK), or Australia (PS71013-AU).

# 3. Installation

## 3.1 ServSwitch Placement

The 2- or 4-Port ServSwitch—DT Pro with Audio is small, portable, and designed to fit on a desktop. Consider the following when deciding where to place the KVM switch:

- How long are the cables attached to your keyboard, mouse, and monitor?
- How far away are the computers from the console?
- How long are the cables you use to connect your computers to the ServSwitch?

### NOTE

**USB signals are strongest when transmitted up to 15 feet (4.6 m) between the KVM and CPU. Beyond this distance, signal degradation may cause the device to fail.**

### CAUTION

**Do not place cables near machines that create electrical noise such as fluorescent lighting, air conditioning equipment, etc.**

## 3.2 Hardware Installation

This section provides instructions for the basic hardware setup of a single ServSwitch.

### CAUTION

**Before you begin, make sure that power to all the devices that you will be connecting is turned off.**

**To prevent damage caused by ground potential differences, make sure that all devices are properly grounded. If you don't follow these instructions, your computers and/or the ServSwitch could be damaged.**

### 3.2.1 CONNECTING THE CONSOLE

1. Power off all computers.
2. Connect your USB keyboard and USB mouse directly to the USB keyboard and mouse ports (labeled with keyboard and mouse symbols) on the front of the ServSwitch. See Figure 3-1.

## 2- AND 4-PORT SERVSWITCH—DT PRO WITH AUDIO

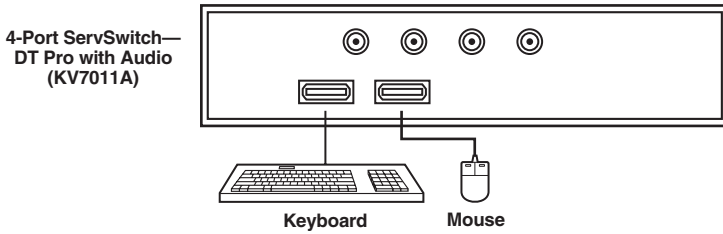

**Figure 3-1. Keyboard and mouse connections.**

3. Connect the HD15 VGA male connector from your monitor to the console VGA port on the back of the ServSwitch. See Figure 3-2.

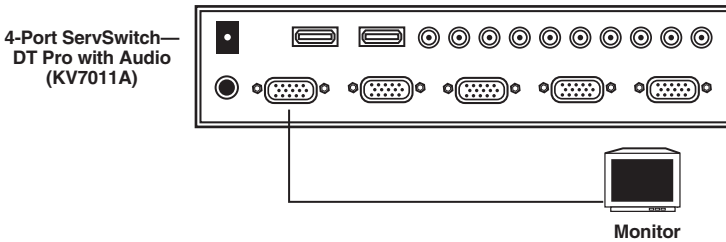

**Figure 3-2. Console connections.**

4. Connect any USB peripheral devices to one of the USB hub ports (labeled Port 1, Port 2, etc.) on the ServSwitch unit's back panel. See Figure 3-3.

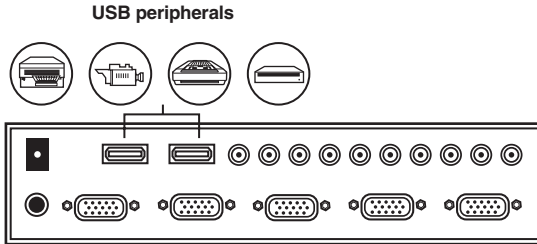

**Figure 3-3. USB peripherals connections.**

5. Connect the peripherals' speaker and microphone ports to the ServSwitch. Using your speakers' attached audio cable, connect the 3.5-mm male plug to the console Audio port (noted by the Audio symbol) on the ServSwitch unit's back panel. Then connect your microphone's attached audio cable to the console's Microphone port (noted by the Microphone symbol) on the ServSwitch unit's back panel. See Figure 3-4.

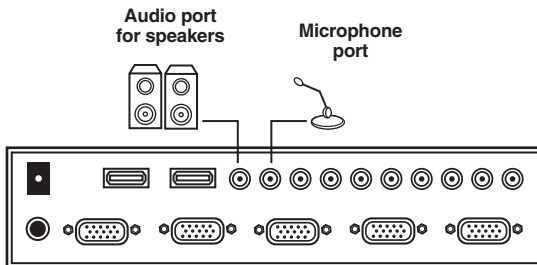

**Figure 3-4. Audio connections.**



## 2- AND 4-PORT SERVSWITCH—DT PRO WITH AUDIO

### 3.2.2 POWERING ON THE SERVSWITCH

Connect the 5-V, 2.5-A power adapter's barrel connector to the power jack on the rear of the switch. Then plug the power adapter cable into an available power outlet. See Figure 3-5.

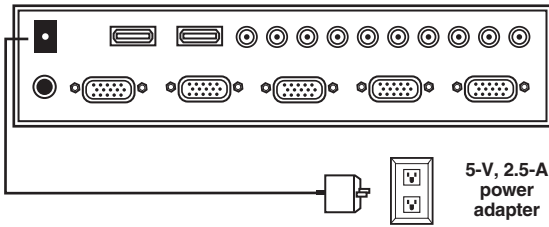

**Figure 3-5. Power connections.**

### 3.2.3 CONNECTING THE COMPUTERS

1. Using the ServSwitch—DT Pro with Audio Cable, connect the USB KVM cable to your computer's USB port, then connect the two audio connectors to the computer's audio (speakers and microphone) connectors. See Figure 3-6.

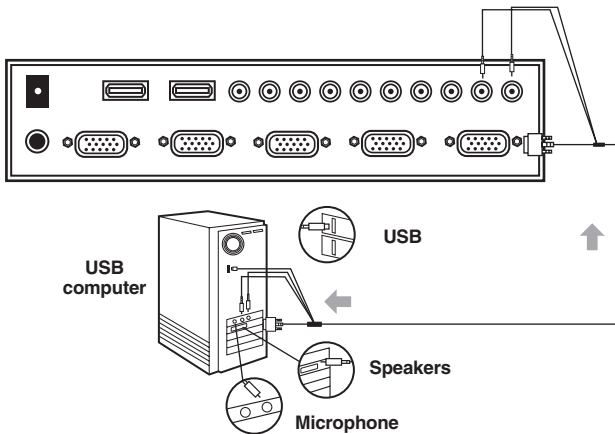

**Figure 3-6. Connecting the computer, speakers, and microphone.**

2. Connect the cable to the speaker and microphone ports (they're color-coded to the PC99 standard) to the ServSwitch unit's back panel. (Refer to Figure 3-6.)
3. Repeat steps 1 through 3 for all computers.
4. Power on your computers. Your computers' operating systems should recognize the ServSwitch and will automatically install the USB driver if it was not already installed on your computers.

### **NOTE**

**On some computers, you must enable USB support on your system BIOS. Please refer to your computer manufacturer's manual or the motherboard manual to verify that USB support is enabled.**

## 4. Operation

### 4.1 Powering Up the System

Once all cables have been connected and all computers have been powered on, the ServSwitch emulates mouse and keyboard signals on each port, allowing your computer to boot normally. The ServSwitch is now ready for use.

### 4.2 Selecting Computers Using Front-Panel Buttons

You can instantly select any computer by pressing the port selector buttons on the front panel. The corresponding LED will light when the port is selected.

### 4.3 Selecting Computers Using Keyboard Hotkey Commands

To directly switch the KVM control to any computer via the simple keyboard command sequence, press the <Left-Ctrl> key twice and the <up-arrow> and <down-arrow> keys.

1. To invoke the hotkey mode, press the <Left-Ctrl> key twice within two seconds. The switch will beep to indicate that it's in hotkey mode.
2. Press the <up-arrow> or <down-arrow> keys to switch to the previous or next port, respectively.

Table 4-1 lists the hotkey commands.

Table 4-1. Hotkey commands.

Command	Description
<Left-Ctrl><Left-Ctrl> H X	Switch to USB hub device only.
<Left-Ctrl><Left-Ctrl> <up arrow>	Switch to previous active PC.
<Left-Ctrl><Left-Ctrl> <down arrow>	Switch to next active PC.
<Left-Ctrl><Left-Ctrl> A X	Switch both the PC and USB hub device.
<Left-Ctrl><Left-Ctrl> C X	Switch the KVM control only.
<Left-Ctrl><Left-Ctrl> 0	Begin AutoScan.
Any key	Stop AutoScan.
<Left-Ctrl><Left-Ctrl> S	Enable/disable “beep” sound.

X = 1, 2, 3, 4

H = USB hub device

A = Combined PC and hub

## NOTE

After switching ports, there is a delay of up to 2 seconds before the video displays. This is normal and is due to the video signal’s refresh rate.

### 4.3.1 SELECTING USB DEVICES CONNECTED TO THE 2- AND 4-PORT USB 2.0 HUB

The ServSwitch unit’s built-in 2- and 4-port USB 2.0 hub allows you to connect additional shared peripherals on a one-computer-at-a-time basis. When you connect a USB device to the ServSwitch, the device can be accessed through any computer that is connected to the installation via a simple hotkey command sequence (<Left-Ctrl><Left-Ctrl> H X).

### 4.3.2 SWITCHING USB DEVICES ONLY

Using the hotkey command sequence below, you can share any device attached to the ServSwitch unit's built-in USB 2.0 hub from your currently selected computer.

1. To invoke the hotkey mode, press the <Left-Ctrl> key twice within two seconds.
2. Press the H key followed by the corresponding port number (1–4).

For example, pressing <Left-Ctrl><Left-Ctrl> H 1 switches USB hub access to the computer on port 1.

### 4.3.3 SWITCHING TO ANOTHER COMPUTER BUT ALLOWING USB DEVICES TO REMAIN ON THE CURRENT PORT

Using the hotkey command sequence below, you can asynchronously switch the KVM control and the USB devices. For example, you can print from one computer and switch the KVM control to another computer simultaneously.

1. To invoke the hotkey mode, press the <Left-Ctrl> key twice within two seconds.
2. Press the C key followed by the corresponding port number (1–4).

For example, pressing <Left-Ctrl><Left-Ctrl> C 1 switches the KVM control to the computer on port 1, but the USB device access remains on the port it was.

## NOTE

**Some USB storage devices are not suitable for dynamic port switching applications.**

### 4.3.4 SWITCHING COMPUTERS AND USB DEVICES

Using the hotkey command sequence below, you can asynchronously switch the KVM control and the USB device access to any computer.

1. To invoke the hotkey mode, press the <Left-Ctrl> key twice within two seconds.
2. Press the A key followed by the corresponding port number (1–4).

For example, pressing <Left-Ctrl><Left-Ctrl> A 4 switches the KVM control and the USB hub access to the computer on port 4.

### 4.3.5 AUTO SCAN

The AutoScan feature allows you to monitor the activity of the connected computers at regular ten-second intervals so that you can monitor the computer activity without having to press the front-panel pushbuttons. This time interval cannot be changed.

To invoke AutoScan, press <Left-Ctrl><Left-Ctrl> 0.

## NOTES

**The interval between these two keys should be no more than a half second. Once the scanning begins, it continues until you press any key to exit AutoScan.**

**A flashing port LED indicates that the connected computer is running AutoScan.**

### 4.3.6 FLASH UPGRADE

With Internet flash-upgrade capability, you can update your ServSwitch with the latest firmware upgrades. Call Tech Support for details.

# Appendix. Troubleshooting

## A.1 Calling Black Box

If you determine that your 2- or 4-Port ServSwitch—DT Pro with Audio is malfunctioning, do not attempt to alter or repair the unit. It contains no user-serviceable parts. Contact Black Box at 724-746-5500.

Before you do, make a record of the history of the problem. We will be able to provide more efficient and accurate assistance if you have a complete description, including:

- the nature and duration of the problem.
- when the problem occurs.
- the components involved in the problem.
- any particular application that, when used, appears to create the problem or make it worse.

## A.2 Shipping and Packaging

If you need to transport or ship your 2- or 4-Port ServSwitch—DT Pro with Audio:

- Package it carefully. We recommend that you use the original container.
- If you are shipping the 2- or 4-Port ServSwitch—DT Pro with Audio for repair, make sure you include everything that came in the original package. Before you ship, contact Black Box to get a Return Authorization (RA) number.