

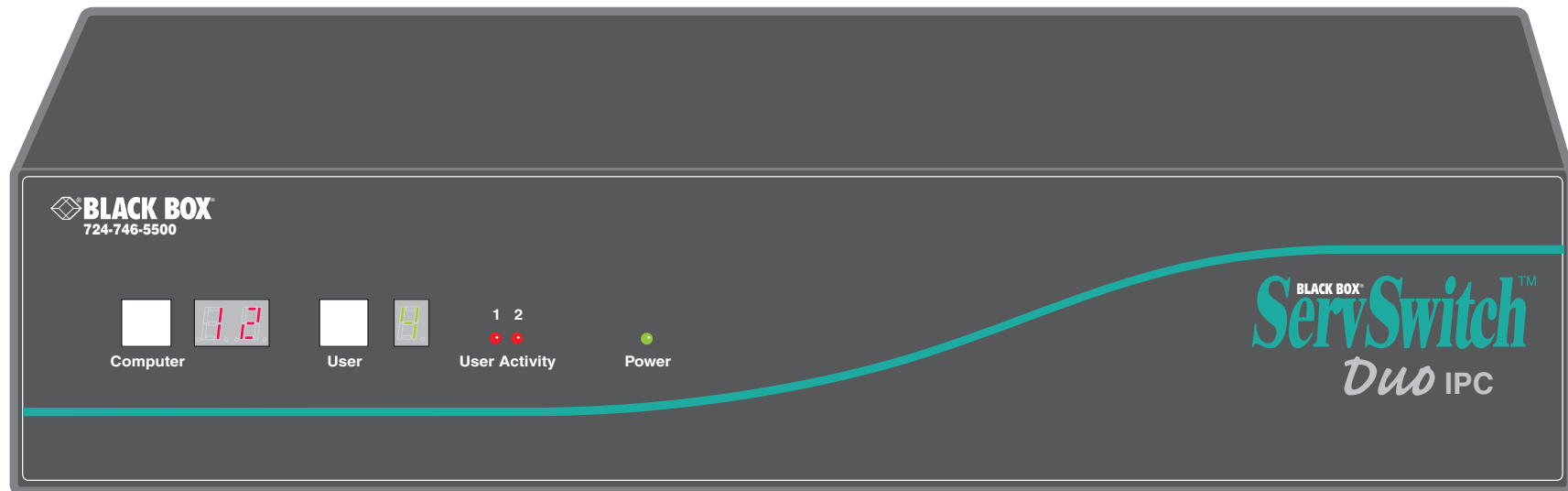

ServSwitch™ Duo IPC

USER GUIDE



**CUSTOMER
SUPPORT
INFORMATION**

Order **toll-free** in the U.S.: Call **877-877-BBOX** (outside U.S. call **724-746-5500**)
FREE technical support 24 hours a day, 7 days a week: Call **724-746-5500** or fax **724-746-0746**
Mailing address: **Black Box Corporation**, 1000 Park Drive, Lawrence, PA 15055-1018
Web site: www.blackbox.com • E-mail: info@blackbox.com

CONTENTS

Contents



Welcome

| | |
|--------------------------------------|---|
| Introduction | 3 |
| What's in the box | 4 |
| What you may additionally need | 4 |

Installation

| | |
|---|----|
| Mounting | 5 |
| Connections | 5 |
| User port connections..... | 6 |
| Computer port connections to standard computers | 6 |
| Computer port connections to alternative computers..... | 7 |
| Connections to a Sun® computer | 7 |
| Connections to a USB port..... | 8 |
| Power supply connection | 9 |
| Wizard IP connections | 10 |
| Power switching connections..... | 11 |
| Cascade connections..... | 12 |
| How cascade connections operate | 13 |
| Addressing computers in a cascade | 14 |
| Using cascaded computers..... | 15 |
| Testing specific links to cascaded computers..... | 15 |
| Multiple video head connections | 16 |

Configuration

| | |
|--|----|
| Overall initial configuration | 17 |
| Configuration menus | 18 |
| Configuration menus layout | 19 |
| Registering users..... | 20 |
| Registering computers..... | 20 |
| Autoscanning | 21 |
| Saving and restoring configuration settings..... | 22 |
| Preparations for configuration save/load | 22 |
| What to do if the ADMIN password has been forgotten... | 23 |
| Ensuring that the serial port is available..... | 23 |
| Hot plugging and mouse restoration | 24 |
| Which restore setting do I use?..... | 24 |
| Resetting user port keyboards and mice..... | 25 |
| Disabling mouse acceleration | 25 |
| Power switching configuration..... | 26 |
| Editing power strings..... | 27 |
| Creating power port groups..... | 27 |
| Logging access activity | 28 |
| Display Data Channel (DDC)..... | 28 |
| Port Direct | 29 |

INSTALLATION

CONFIGURATION

OPERATION

FURTHER INFORMATION

INDEX

Operation

| | |
|--------------------------------------|----|
| Powering on | 30 |
| The front panel controls | 30 |
| Using the ServSwitch Duo IPC..... | 31 |
| Selecting a computer | 31 |
| Logging in and out | 33 |
| Selecting cascaded computers | 34 |
| The confirmation box | 34 |
| The reminder banner..... | 34 |
| Routing status | 35 |
| User preferences and functions | 35 |
| Using power switching | 35 |

Further information

| | |
|---|----|
| Troubleshooting | 36 |
| Getting assistance..... | 36 |
| Appendices | 37 |
| Appendix 1 – Configuration menu items | 37 |
| Setup Options..... | 37 |
| Global Preferences | 38 |
| User Preferences..... | 40 |
| Advanced Options..... | 42 |
| Appendix 2 – Firmware upgrade | 43 |
| Appendix 3 – Cable and connector specifications | 45 |
| RS232 serial mouse to PS/2 converter cable | 45 |
| RS232 serial flash upgrade cable..... | 45 |
| RS232 serial synchronisation cable..... | 45 |
| ServSwitch Duo IPC to power switch cable | 46 |
| Power switch to power switch daisy chain cable | 46 |
| ServSwitch Duo IPC setup cable | 46 |
| Safety information | 47 |
| Radio Frequency Energy | 48 |
| Normas Oficiales Mexicanas (NOM) electrical safety statement..... | 49 |
| Instrucciones de seguridad | 49 |

Index

| | |
|--|----|
| BlackBox subsidiary contact details..... | 52 |
|--|----|



| |
|---------------------|
| INSTALLATION |
| CONFIGURATION |
| OPERATION |
| FURTHER INFORMATION |
| INDEX |

Welcome

Introduction

Thank you for choosing the ServSwitch Duo IPC from Black Box. This advanced switch allows you to control multiple host computers directly, or far more computers in combination with other similar switches. Two users can simultaneously access any connected host computers. With the addition of the optional Wizard IP unit, the user(s) can be situated anywhere via the internet.

In common with other advanced switching devices, the ServSwitch Duo IPC and Wizard IP both support the [Port Direct](#) format. This messaging system allows the interconnected switches to declare between themselves the locations and requirements of their respective host computers. This greatly eases configuration and simplifies host computer selection.

Optional network/Internet remote control

The optional Wizard IP allows direct connection to an Ethernet-based local network and from there onto the wider Internet, as required. The robust Wizard IP security system will also allow direct connection to the Internet. A second Wizard IP can be added to the other user port to provide even greater remote connectivity. The Wizard IP also provides a local user connection port.

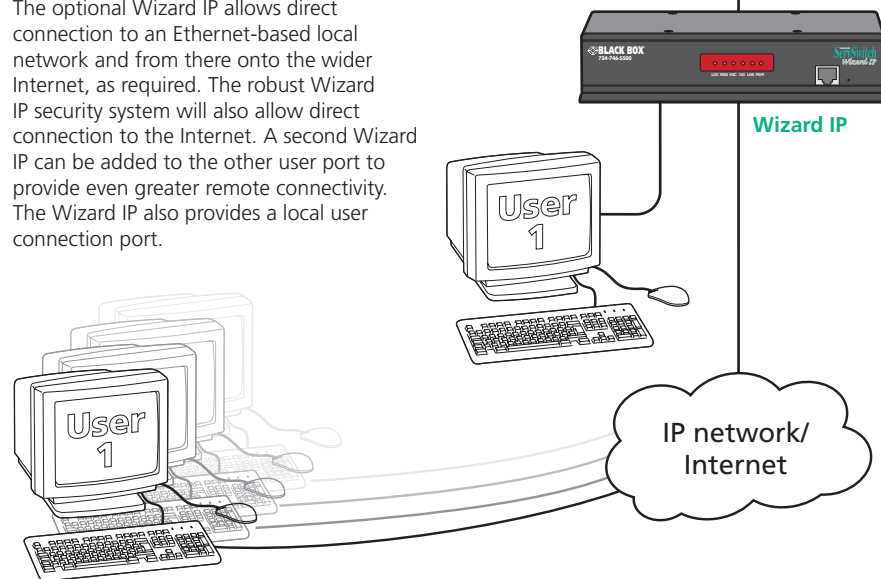

Dual users

ServSwitch Duo IPC allows control of the host systems by two directly connected keyboard/video/mouse sets. Alternatively, a Wizard IP can be connected instead to provide remote control options.

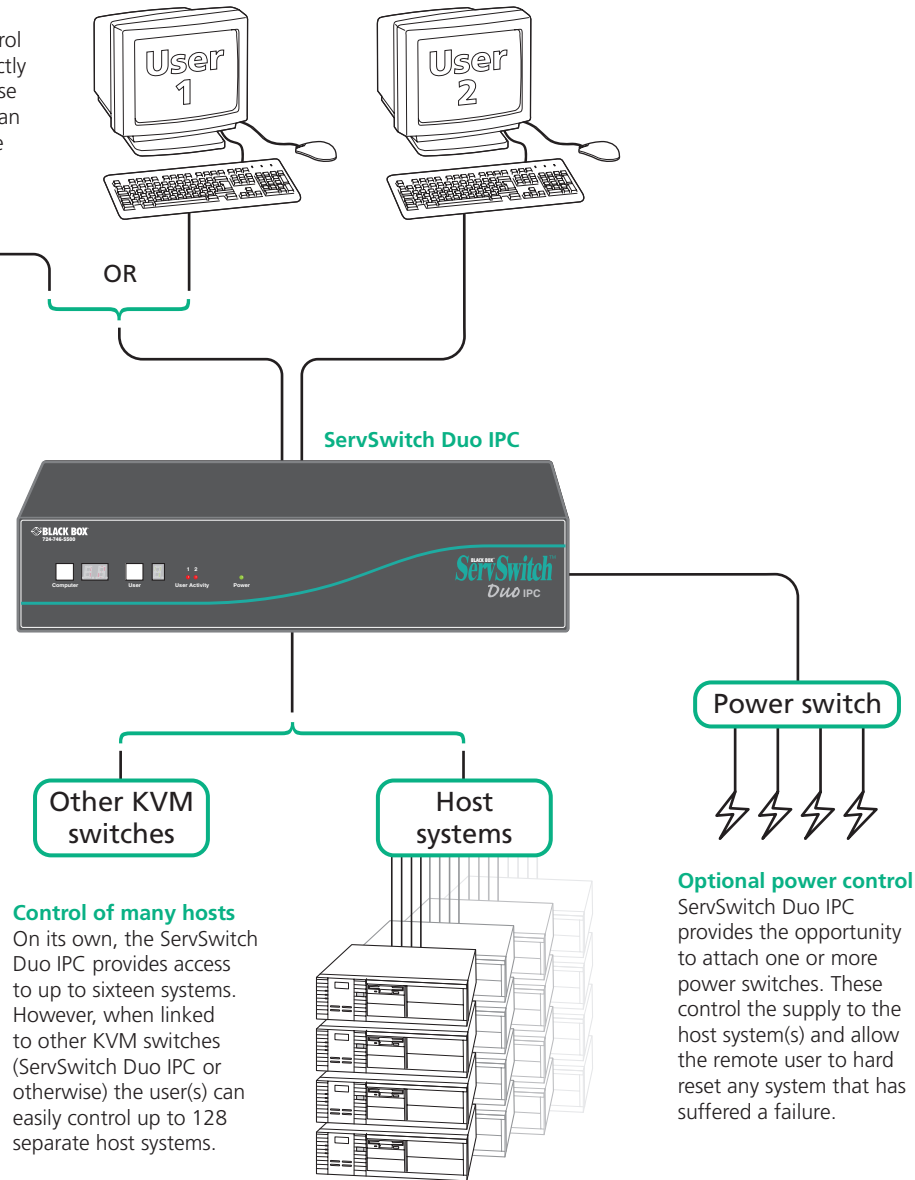

Control of many hosts

On its own, the ServSwitch Duo IPC provides access to up to sixteen systems. However, when linked to other KVM switches (ServSwitch Duo IPC or otherwise) the user(s) can easily control up to 128 separate host systems.

Optional power control

ServSwitch Duo IPC provides the opportunity to attach one or more power switches. These control the supply to the host system(s) and allow the remote user to hard reset any system that has suffered a failure.



INSTALLATION

CONFIGURATION

OPERATION

FURTHER INFORMATION

INDEX

What's in the box

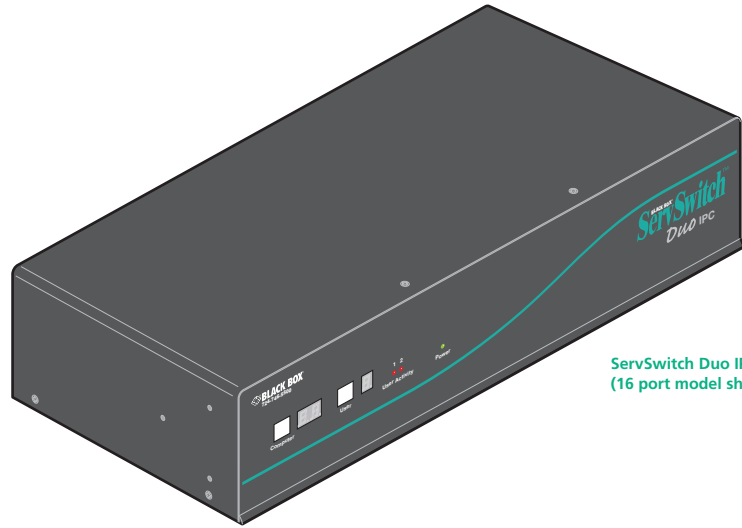

ServSwitch Duo IPC
(16 port model shown)

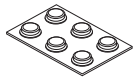

Six self-adhesive
rubber feet

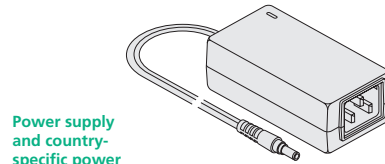

Power supply
and country-
specific power
lead

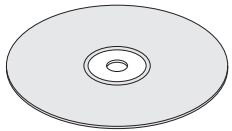

CD-ROM

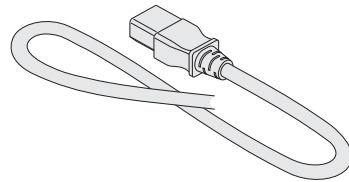

Slave power switches for connection to Wizard IP or master power switch
(part number: Contact Black Box technical support)

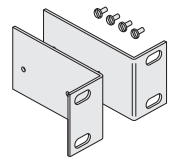

Rack brackets for 8 port
model plus four screws

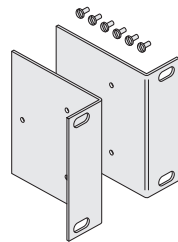

Rack brackets for 16 port
model plus six screws

What you may additionally need

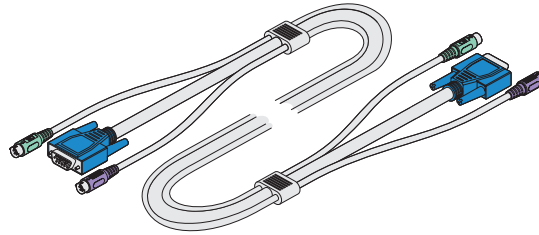

PS/2 cables
One set per connected computer.
Part numbers:
EHN408-0005 5 feet in length
EHN408-0010 10 feet in length
EHN408-0020 20 feet in length

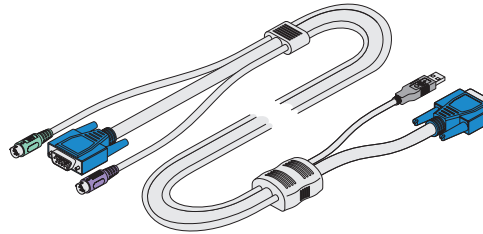

PS/2 to USB flash cables
Required to connect with computers that use a USB port to connect their keyboard and mouse.
Part numbers:
EHN428-0006 6 feet in length
EHN428-0016 16 feet in length
EHN428-0035 35 feet in length

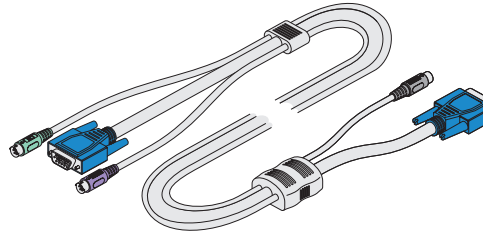

PS/2 to Sun flash cables
Required to connect Sun computers that use a mini-DIN port to connect their keyboard and mouse.
Part numbers:
EHN429-0006 6 feet in length
EHN429-0016 16 feet in length
EHN429-0035 35 feet in length

Master power switch for connection to Wizard IP or standalone Ethernet operation (part number: Contact Black Box technical support)

PS/2 to AT-style keyboard converter (part number: FA212)

PS/2 to 9-pin serial mouse converter (part number: FA314)



INSTALLATION

CONFIGURATION

OPERATION

FURTHER INFORMATION

INDEX

Installation

This chapter covers the physical mounting and connection of the ServSwitch Duo IPC.

Mounting

The initial step is to mount the ServSwitch Duo IPC in an optimum position, where:

- It is in close proximity to the various computers that will be connected to it.
- There is a power supply socket.
- Optionally, there is an Category 5e or 6 network connection, if the Wizard IP is also being used.

The ServSwitch Duo IPC can be used on a desktop or mounted within a 19" rack. For desktop applications, attach the supplied self-adhesive feet to the underside to avoid damage to the desktop surface. For rack-mount applications, use the optional brackets and mount the unit within the frame before connecting any cables.

To attach the rack-mount brackets

- 1 On either side of the ServSwitch Duo IPC casing, position a rack mount bracket with the slotted holes facing out from the front of the unit.
- 2 Secure the bracket with three of the supplied screws.

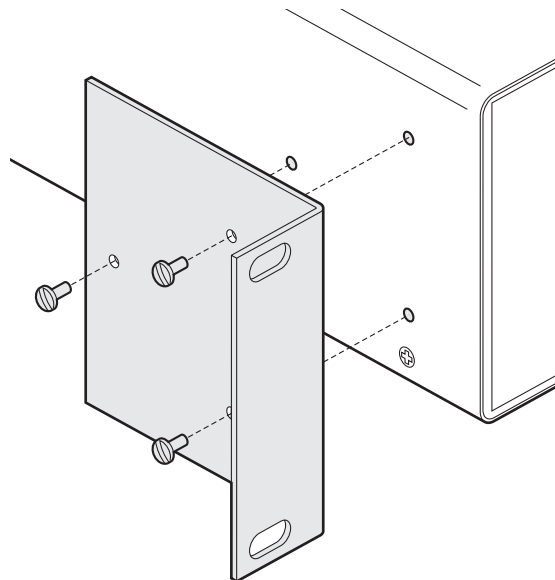

ServSwitch Duo IPC (16 port model)

Connections

Installation of the ServSwitch Duo IPC involves numerous connections, which can be classified into the following basic groups:

- [User port connections](#)
- [Computer port connections to standard computers](#)
- [Computer port connections to alternative computers](#)
- [Power supply connection](#)

There are also connections that can be made to achieve more advanced configurations:

- [Wizard IP connections](#)
- [Power switching connections](#)
- [Cascade connections](#)
- [Multiple head video connections](#)

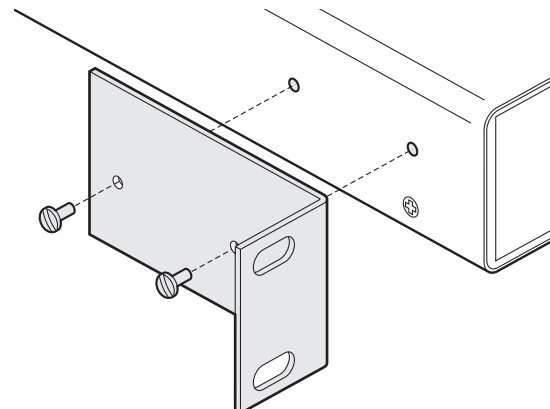

ServSwitch Duo IPC (8 port model)



User port connections

There are two user ports available at the rear of the ServSwitch Duo IPC. Each port consists of three sockets to accommodate: a keyboard, a video monitor and a mouse.

Keyboard and mouse mode logging

The ServSwitch Duo IPC maintains a log of all keyboard and mouse mode and resolution settings that are requested by each of the connected computers. These settings are automatically restored to the shared keyboards and mice of the user ports when the ServSwitch Duo IPC channels are switched, thus ensuring maximum software compatibility. The keyboard num, caps and scroll lock states are a visible example of this process.

Data Display Channel (DDC) considerations

DDC allows the ServSwitch Duo IPC to discover the capabilities of a user port video monitor and transmit that information to the connected computers so that they can moderate their video output to suit the monitor. DDC can only sample one monitor, so if you are connecting monitors of different resolution/frequency capabilities, it is important to ensure that the DCC feature samples the lesser of the two monitors. Please see [Display Data Channel](#) for details.

To connect a user port

- 1 Ensure that power is disconnected from the ServSwitch Duo IPC and all devices to be attached.
- 2 Connect the cables from your keyboard, video monitor and mouse to the three sockets of the required USER PORT (1 or 2), at the rear of the ServSwitch Duo IPC (for keyboard and mouse plug conversion information – see [Appendix 3](#)).

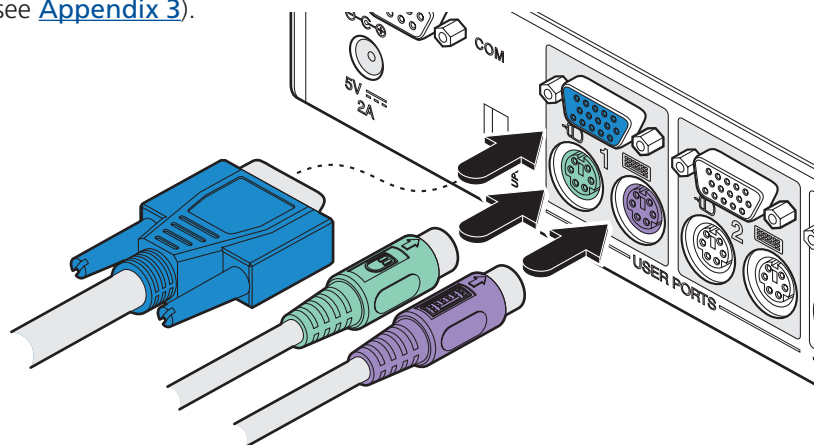

Note: Between the two user ports, no commonality of keyboards, video monitors or mice is required as all devices attached to each port are handled individually. However, please note the DDC considerations above.

Computer port connections to standard computers

Depending on the model, ServSwitch Duo IPC can be *directly* connected to a maximum of either eight or sixteen computer systems. Using KVM cable sets (part number: EHN408-00xx - where x is the length: 05, 10 or 20 feet), each computer is connected to one of the numbered ports at the rear of the ServSwitch Duo IPC. [Connecting to Sun computers and USB ports](#).





Further computers may be connected, by linking other switching products using a cascade arrangement (explained in the [Cascade connections](#) section).

To connect a computer

- 1 Ensure that power is disconnected from the ServSwitch Duo IPC and all computers to be connected.

(Note: If it is not possible to switch off a computer prior to connection, then a 'Hot plug' procedure is available – see the [Hot plugging and mouse restoration](#) section for more details).

- 2 Connect the plugs at one end of a KVM cable set to the keyboard, video and mouse sockets of the computer (for keyboard and mouse plug conversion information – see [Appendix 3](#)).

| | | |
|-----------------|--|-----------|
| Monitor (video) |  | Blue |
| Keyboard |  | Purple |
| Mouse |  or  | Mid green |

- 3 Connect the plugs at the other end of the KVM cable set to the corresponding sockets, of the required COMPUTER PORT at the rear of the ServSwitch Duo IPC.

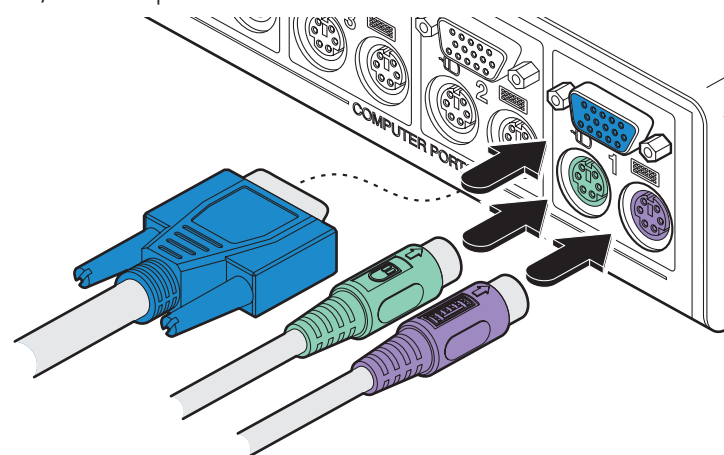

Note: Not all of the computer ports need be used and not all connected computers need to be switched on, ServSwitch Duo IPC can sense the presence or absence of computers.



Computer port connections to alternative computers

ServSwitch Duo IPC is intended to connect directly to computers that have separate circular mini-DIN connectors for keyboard and mouse. Not all computers use such an arrangement, so Black Box can supply converter cables for use with either Sun® computers or [computers that use a USB port for keyboard and mouse](#).

Connections to a Sun® computer

Some Sun computers use a single mini-DIN connector for both keyboard and mouse. The Sun converter cable (part number: EHN429-00xx - *where x is the length: 06, 16 or 35 feet*) allows Sun computers to be connected to the ServSwitch Duo IPC.

To connect a Sun computer

- 1 Ensure that power is disconnected from the ServSwitch Duo IPC and the Sun computer to be connected.
- 2 At the end of the converter cable that has three plugs, connect the keyboard, mouse and video plugs to the three sockets of the chosen COMPUTER PORT at the rear of the ServSwitch Duo IPC.

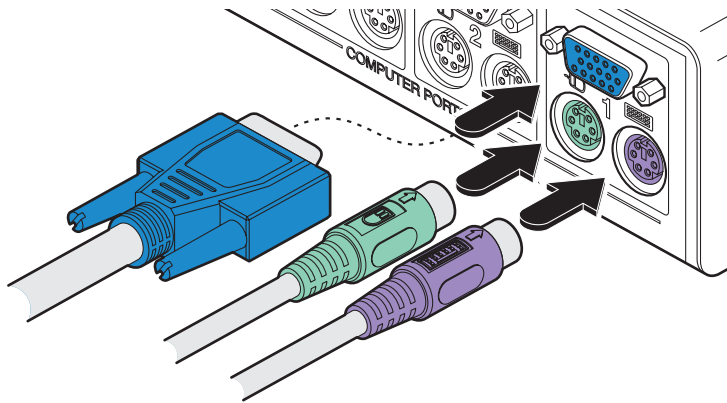

- 3 At the other end of the converter cable (with two plugs), connect the video plug and Sun keyboard/video plug to the relevant sockets on the computer.

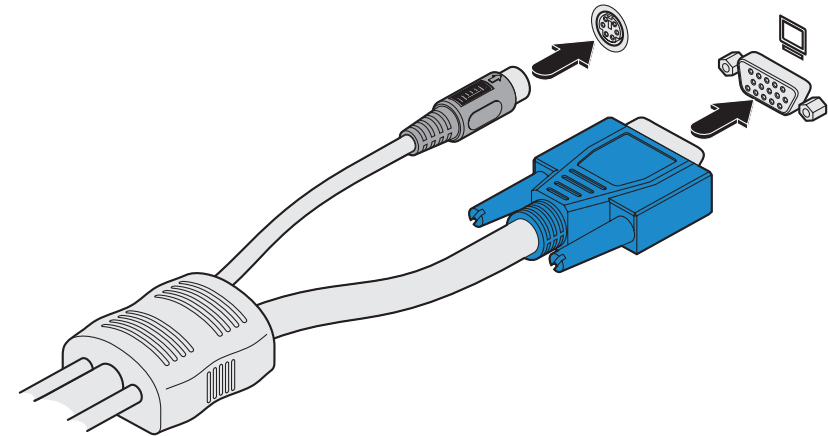

When the ServSwitch Duo IPC and Sun computer are switched on, the ServSwitch Duo IPC will interact with the converter cable and together they will pass an appropriate keyboard code to the computer.

Keypress equivalents

The table given here provides equivalent keypresses on a standard PC (PS/2-style) keyboard that emulate special keys found on Sun keyboards.

| PS/2 keyboard | Sun keyboard |
|--------------------|--------------|
| Right-[Ctrl] [F1] | Stop |
| Right-[Ctrl] [F2] | Again |
| Right-[Ctrl] [F3] | Props |
| Right-[Ctrl] [F4] | Undo |
| Right-[Ctrl] [F5] | Front |
| Right-[Ctrl] [F6] | Copy |
| Right-[Ctrl] [F7] | Open |
| Right-[Ctrl] [F8] | Paste |
| Right-[Ctrl] [F9] | Find |
| Right-[Ctrl] [F10] | Cut |
| Right-[Ctrl] [1] | Mute |
| Right-[Ctrl] [2] | Volume - |
| Right-[Ctrl] [3] | Volume + |
| Right-[Ctrl] [4] | Power* |
| Right-[Ctrl] [H] | Help |

* Certain PS/2 keyboards have a power key which will be mapped to perform the same function for a Sun computer.



Connections to a USB port

Some computers are not fitted with dedicated keyboard and mouse ports and instead rely on USB keyboards and mice. The USB converter cable (part number: EHN428-00xx - where x is the length: 06, 16 or 35 feet) allows such computers to be connected to the ServSwitch Duo IPC.

To connect a USB port computer

- 1 Ensure that power is disconnected from the ServSwitch Duo IPC and the computer to be connected.
- 2 At the end of the converter cable that has three plugs, connect the keyboard, mouse and video plugs to the three sockets of the chosen COMPUTER PORT at the rear of the ServSwitch Duo IPC.

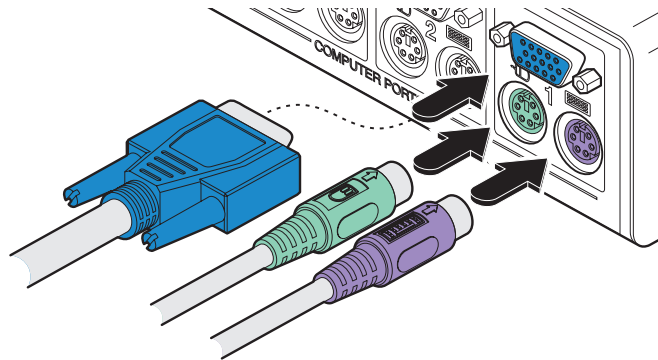

- 3 At the other end of the converter cable (with two plugs), connect the video plug and USB plug to the relevant sockets on the computer.

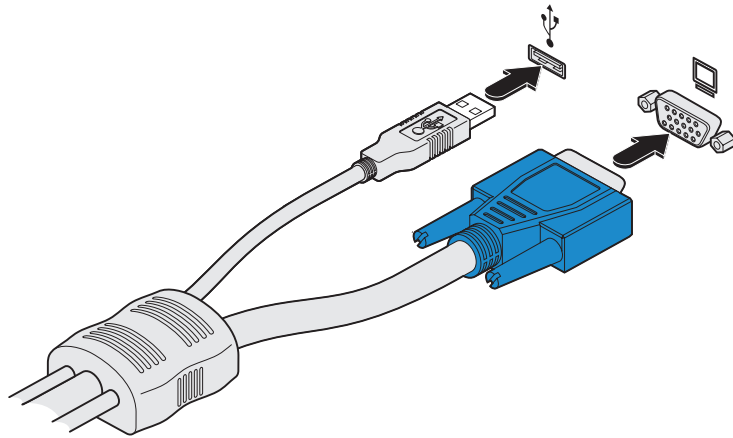

When the ServSwitch Duo IPC and computer are switched on, the ServSwitch Duo IPC will interact with the converter cable and together they will pass an appropriate keyboard code to the computer.

Keypress equivalents

The tables given here provide equivalent keypresses on a standard PC (PS/2-style) keyboard that emulate special keys found on Apple®, Microsoft® or Sun® keyboards.

Note: To use the Sun® equivalent keypresses, you must first download the relevant files from [Black Box support](#).

| PS/2 keyboard | Apple keyboard | PS/2 keyboard | Sun keyboard |
|------------------------|--------------------|--------------------|--------------|
| Left Ctrl | Left Control | Right-[Ctrl] [F1] | Stop |
| Left Win Start (⊞) | Left Command (⌘) | Right-[Ctrl] [F2] | Again |
| Left Alt | Left Option (alt) | Right-[Ctrl] [F3] | Props |
| Right Alt or Alt Graph | Right Option (alt) | Right-[Ctrl] [F4] | Undo |
| Right Win Start (⊞) | Right Command (⌘) | Right-[Ctrl] [F5] | Front |
| Right Ctrl | Right Control | Right-[Ctrl] [F6] | Copy |
| Windows App. key | No equivalent | Right-[Ctrl] [F7] | Open |
| No equivalent | On / off key | Right-[Ctrl] [F8] | Paste |
| | | Right-[Ctrl] [F9] | Find |
| | | Right-[Ctrl] [F10] | Cut |
| | | Right-[Ctrl] [1] | Mute |
| | | Right-[Ctrl] [2] | Volume - |
| | | Right-[Ctrl] [3] | Volume + |
| | | Right-[Ctrl] [4] | Power* |
| | | Right-[Ctrl] [H] | Help |

* Certain PS/2 keyboards have a power key which will be mapped to perform the same function for a Sun computer.

When used with Sun® workstations, your USB converter needs to report a keyboard country code to the host computer. Further details about this feature are available from [Black Box support](#).



Power supply connection

The ServSwitch Duo IPC is supplied with a single power supply and an appropriate country-specific IEC power lead. The ServSwitch Duo IPC does not have an on/off switch so operation begins as soon as the power supply is connected.

Note: When computers are first powered on they communicate with any attached keyboards and mice in order to setup parameters required by their operating system. It is necessary for the ServSwitch Duo IPC to be attached and powered on during this sequence so that it can give the required responses and keep track of all modes and settings requested by each of the connected computers.

To connect the power supply

- 1 Connect the low voltage output connector from the power supply unit to the ServSwitch Duo IPC power socket in the lower left corner of the rear panel.

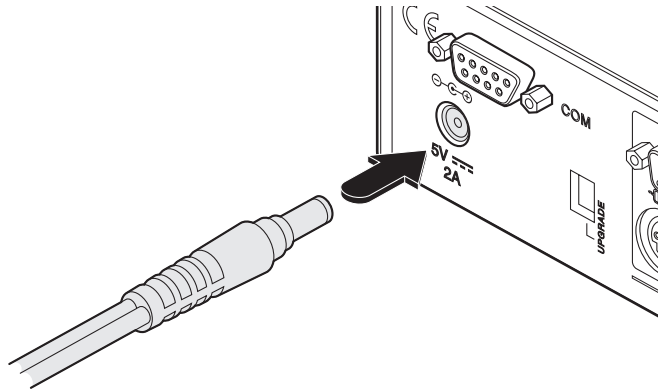

- 2 Connect the IEC connector of the supplied country-specific power lead to the socket of the power supply.

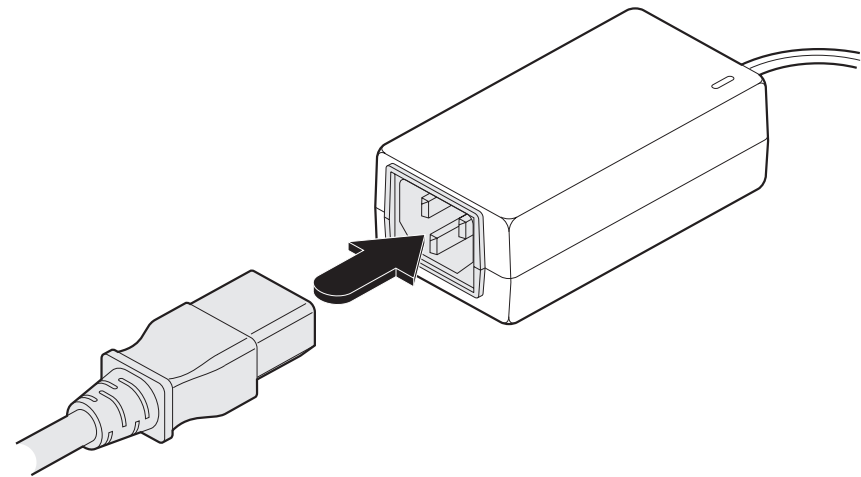

- 3 Connect the power lead to a nearby mains supply socket.



Wizard IP connections

When linking the ServSwitch Duo IPC with one (or two) Wizard IP unit(s), the latter take the place of one (or both) of the two user port consoles. The Wizard IP then enables control of the ServSwitch Duo IPC from remote positions. Where multiple ServSwitch Duo IPC units are [cascaded](#), the Wizard IP should be connected to the top level ServSwitch Duo IPC.

To connect a Wizard IP

- 1 Ensure that power is disconnected from the ServSwitch Duo IPC and all computers to be connected.
- 2 Using a standard KVM cable set (part number: EHN408-00xx - where x is the length: 05, 10 or 20 feet), connect the plugs at one end of the KVM cable set to the keyboard, video and mouse sockets at the rear of the Wizard IP, collectively labelled 'COMPUTER/KVM SWITCH'.
- 3 Connect the plugs at the other end of the KVM cable set to the corresponding sockets, of either of the two USER PORTS, at the rear of the ServSwitch Duo IPC.
- 4 If required, connect a local keyboard, video monitor and mouse to the three sockets collectively labelled 'KVM CONSOLE' at the rear of the Wizard IP.
- 5 Connect the plug of a category 5e or 6 cable into the IP port on the front panel of the Wizard IP.
- 6 Connect the low voltage output connector from the supplied power supply unit to the Wizard IP power socket in the lower left corner of its rear panel.
- 7 Connect the IEC connector of the supplied country-specific power lead to the socket of the power supply. Connect the power lead to a nearby main supply socket.
- 8 Reconnect the power lead to the ServSwitch Duo IPC.

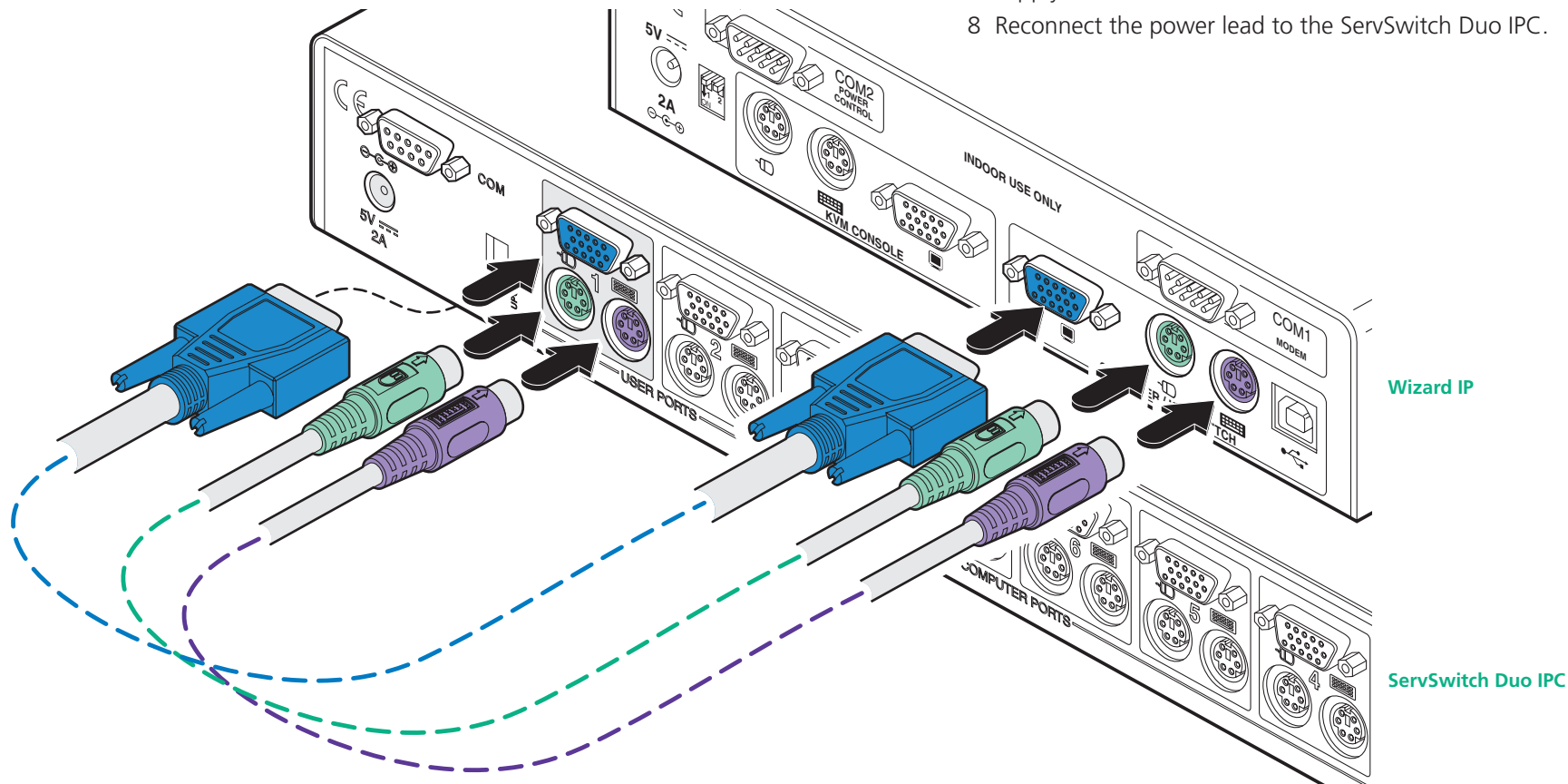

Power switching connections

A key feature of the ServSwitch Duo IPC is its ability to remotely control the power of the computers attached to it. The actual power switching process requires the use of optional switch boxes, however, the ServSwitch Duo IPC offers the control port for these switches and the necessary operational integration within its menu system.

The control connector of the first power switch is connected, via serial cable, to the rear panel of the ServSwitch Duo IPC. Any additional power switches are then connected via a 'daisy-chain' arrangement to the first power switch. Each power switch box is then given a unique address and access to each power port (8 ports on each power switch box) is gained using a combination of the switch box address and the port number.

Each power port can then be connected to the power inputs of each computer and each power switch box then connected to a mains power supply.

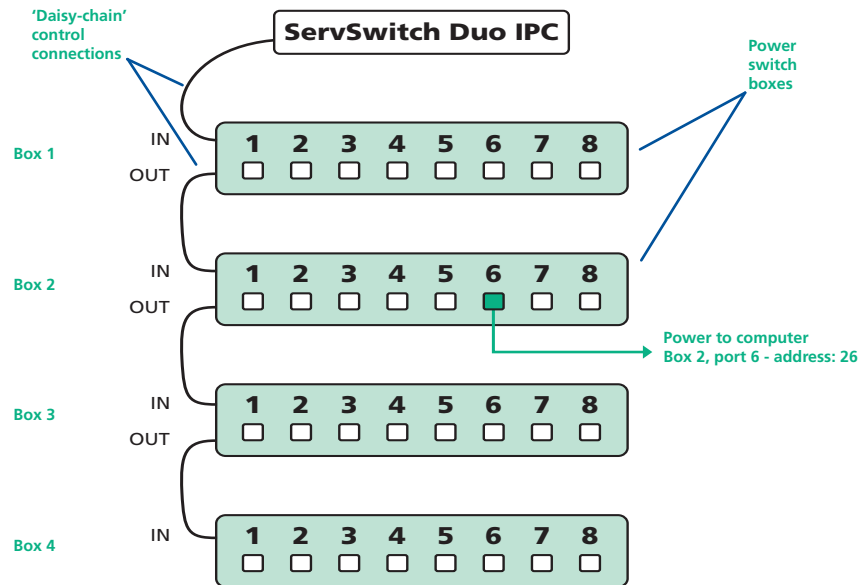

IMPORTANT: Power switching devices have a maximum current rating. It is essential to ensure that the total current drawn by the equipment connected to the power switching device does not exceed the current rating of the power switching device. You must also ensure that the current drawn from any mains socket does not exceed the current rating of the mains socket.

Setting up, configuring and using power switching requires three main steps:

- Connect and address the switch boxes ⇨
- [Configure the power strings](#)
- [Operate remote power switching](#)

To connect and address the switch boxes

Note: The ServSwitch Duo IPC can be powered on during this procedure, however, the switch boxes should be switched off.

- 1 Mount up to four switch boxes in positions where they are close to the computers that they will control and not too distant from the ServSwitch Duo IPC (preferably within 8 feet).
- 2 Use a serial cable with an RJ9 and a 9-pin D-type connector (see [Appendix 3](#) for specification). Connect the RJ9 plug to the socket marked 'IN' on the first switch box. Connect the other end to the socket marked 'COM' on the ServSwitch Duo IPC.

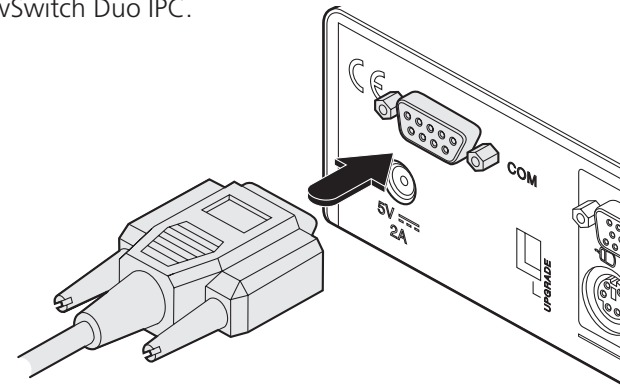

- 3 For each of the remaining switch boxes (if used), use a serial cable with RJ9 connectors at both ends (see [Appendix 3](#) for specification). Connect one end to the socket marked 'OUT' of the previous box and the other end to the socket marked 'IN' of the next box.

- 4 Set the addressing switches on each switch box using the two small switches marked 'Slct' on the front panel. The box connected directly to the ServSwitch Duo IPC is Box 1 and so on down the daisy-chain line to Box 4 at the end.

| Box | Switch 1 | Switch 2 |
|-----|----------|----------|
| 1 | Off | Off |
| 2 | On | Off |
| 3 | Off | On |
| 4 | On | On |

Off = switch upwards
On = switch downwards
Switch 1 is on the left side

- 5 Connect IEC to IEC power leads between each port and the power input socket of each computer that requires power switching. Carefully note to which power ports, on which boxes, each computer is connected. If server systems have multiple power inputs, then each input must be connected via separate ports, which can be on the same, or different boxes.
- 6 Connect each box to a suitable mains power input.

Now proceed to the configuration stage covered in the [Power switching configuration](#) section within the Configuration chapter.



Cascade connections

Depending on the model, the ServSwitch Duo IPC supports up to eight or up to sixteen *directly* connected computer systems, however, this is by no means the limit. Thanks to an intelligent communication system, called [Port Direct](#), many more computers can be controlled by connecting other KVM switches to the ServSwitch Duo IPC. The combination of switches can be arranged up to four levels deep forming a tree, or *cascade* arrangement, with computers situated at any level.

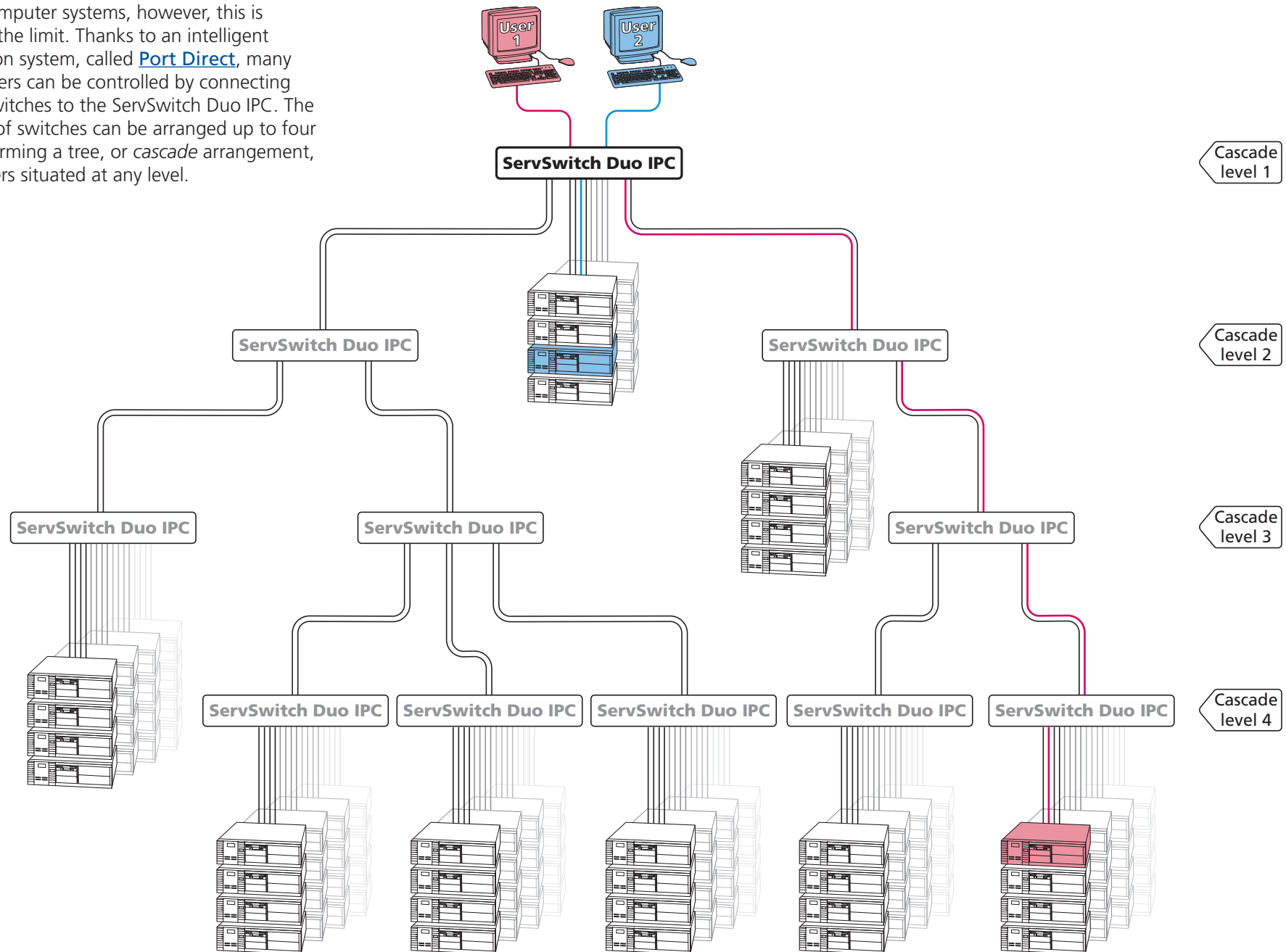

INSTALLATION

CONFIGURATION

OPERATION

FURTHER INFORMATION

INDEX



How cascade connections operate

The method for cascading switching units is straightforward and requires no hardware settings or lengthy configuration process. This is due to the [Port Direct](#) communication system employed by certain advanced switching products that allows them to locate each other and share information.

The method of linking switches is the same regardless of the cascade level, or number of devices attached. Put simply:

- A single cascade link is made by connecting a computer port of one switch to a user port of the switch below it.

Such a single link would allow just one user from the higher switch to access any of the computers (or other switches) attached to the lower one. However, a single link can cause a bottleneck for multi-user systems, so it is commonplace to make dual cascade links between switches. These allow two users to simultaneously access computers situated anywhere within the cascade tree.

When dual cascade links are made between switches, each switch will automatically recognise the dual links and treat them accordingly. The links within a dual group will then be allocated to users according to their general availability in that group, not as specific individual lines. To do this, each link group has an access number, which is determined by the ports to which they are connected on the switch.

For instance, a dual group connected to computer ports 1 and 2 of a switch would always be known as 21, the next dual group connected to ports 3 and 4 would always carry the number 22, and so on. The diagram here summarises the ports to which dual groups must be connected and the resulting group numbers attained in the positions here ⇔

The central purpose of the link group system is that each user can use a unique address to locate a particular computer, however, as with the Internet, the route to get there could be slightly different each time. This avoids any route blocking that could easily be caused by other users occupying any specific link lines.

Port boundaries and numbering for dual link groups (model ACR6208A uses groups 21 to 24 only)

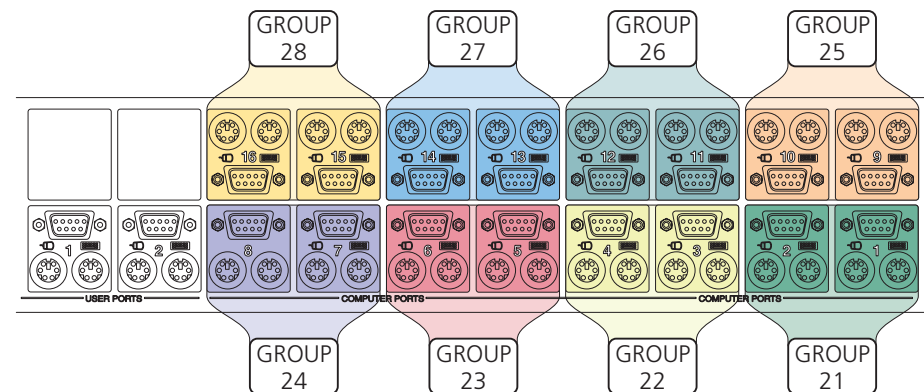

Note: Single links and dual link groups may be mixed on one switch providing the dual link groups lie within the appropriate port boundaries shown above - see [Tips for successful cascading](#) for more details.

Addressing computers in a cascade

The addressing format used by the switches incorporates the various group numbers along with a final specific port number to which a required computer is attached. In the diagram given here, a portion of the previous cascade diagram indicates how the routes to particular computers are formed and addressed.

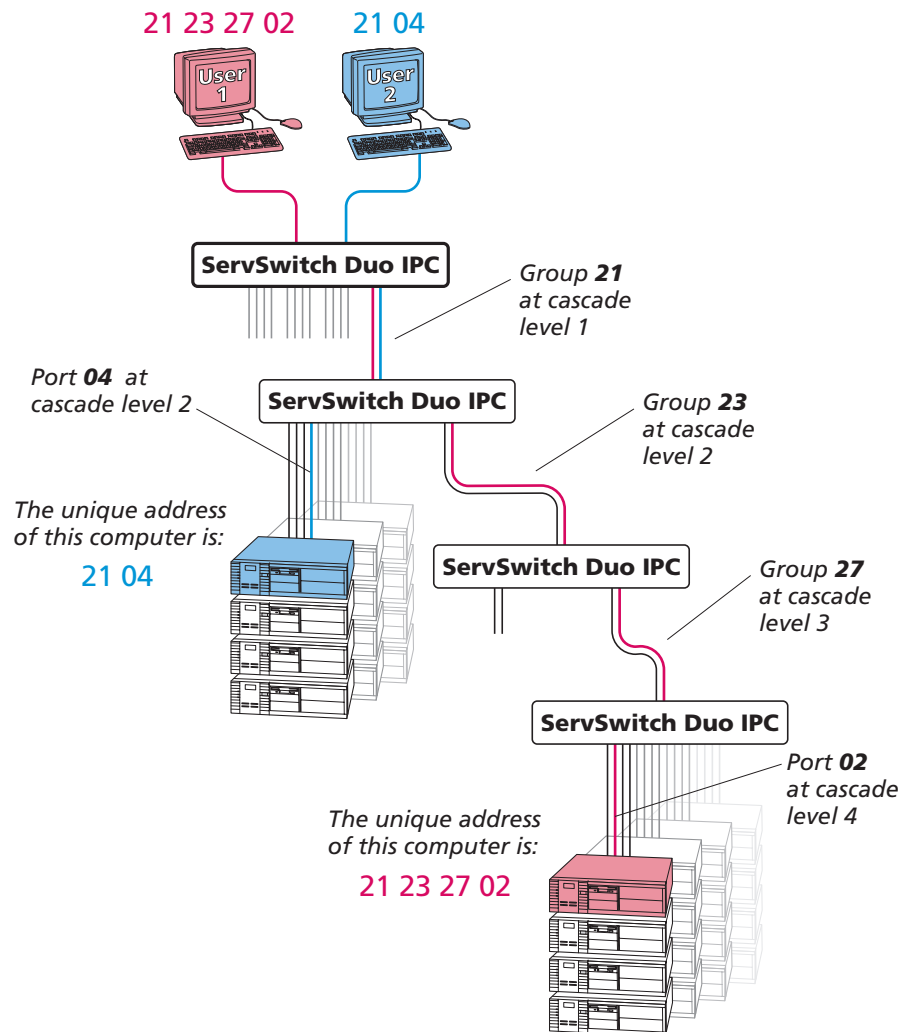

Each cascade level requires two digits, hence the computer marked in red requires a unique address with eight digits because it is at cascade level 4, compared to the blue computer at level 2 with its four digit unique address. A computer connected directly to the ServSwitch Duo IPC at the top level would simply have a two digit port number.

The group at level 2 is numbered 23 because it is a group of two, connected to ports 5 and 6 on the ServSwitch Duo IPC. If it was connected to ports 7 and 8, then the group number would be 24.

If the group at level 3 was connected to ports 15 and 16 of the switch, then the group number would be 28. This would make the address of the red computer: 21 23 28 02.

To connect switches in a cascade arrangement

Note: This procedure may be carried out in any order but for clarity this instruction will begin at the higher level switch (here called the upper switch), i.e. the one that is being fed into by a switch at the cascade level below (here called the lower switch). The procedure given here remains the same regardless of exactly which cascade levels are being connected. The basic rule is that each link is made by connecting a computer port of the upper switch to a user port of the lower switch.

- 1 Ensure that power is disconnected from the ServSwitch Duo IPC and all other switches to be connected.
- 2 For each link, use a standard KVM cable set (part number: EHN408-00xx - where x is the length: 05, 10 or 20 feet) - use the shortest possible lengths.
- 3 Connect the plugs at one end of the KVM cable set to the keyboard, video and mouse sockets of an appropriate Computer port on the rear panel of the upper switch. Refer to the [Group numbering diagram](#) for the correct link group boundaries.

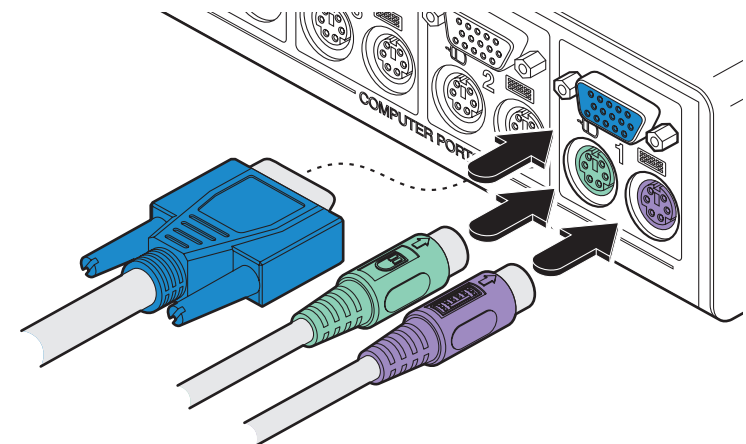

continued



INSTALLATION

CONFIGURATION

OPERATION

FURTHER INFORMATION

INDEX

- 4 Connect the plugs at the other end of the KVM cable set to the keyboard, video and mouse sockets of a *User port* on the rear panel of the lower switch. Due to the way in which ports within a dual group are dynamically allocated, it is not usually important exactly which user port is connected to each computer port of the upper switch.

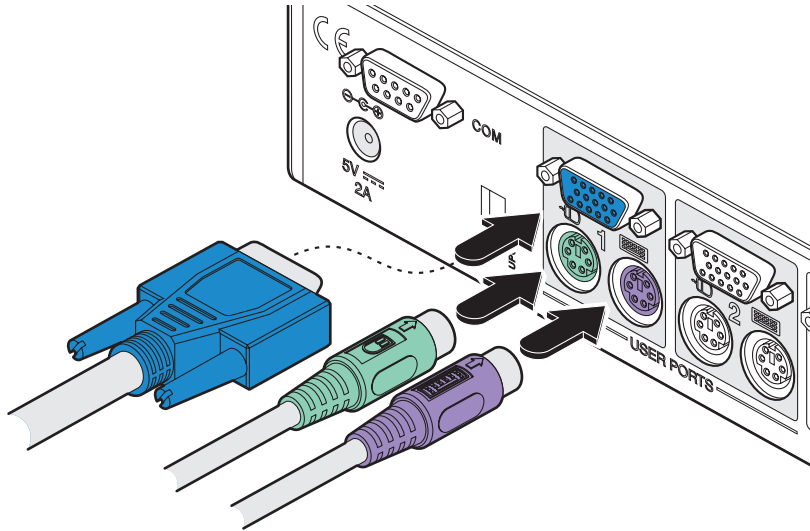

- 5 Repeat steps 3 and 4 for each of the links within the group, adhering to the [Group numbering diagram](#) for the correct link group boundaries on the computer ports on the upper switch.

Once the switches and computers have been connected, you can edit their names to make it much easier to locate them. See the [To create/edit computer names](#) section in the Configuration chapter for more details.

Tips for successful cascading

- The maximum number of levels for a cascade is four.
- The number of links between switches determines the number of users that can simultaneously access the computers situated further down the tree.
- Keep all cascade cables as short as possible to maximise video quality.
- Ensure that dual cascade links (within a group) between switches are approximately the same length.
- Single links and dual link groups may be mixed on one switch providing the dual links lie within the appropriate port boundaries designated in the [Group numbering diagram](#).

Using cascaded computers

In use, cascaded computers can be accessed using exactly the same methods as for those connected directly to the ServSwitch Duo IPC. However, by far the easiest way is to use the on screen menu. This is because it displays the computer names and does not require any knowledge of port addresses, some of which (as discussed above) can be up to eight digits long. See the [Selecting cascaded computers](#) section in the Operation chapter for more details.

Testing specific links to cascaded computers

As mentioned previously, the best and most efficient way to access cascaded computers is by using the on screen menu and via non-specific routes through the link groups. However, during configuration or troubleshooting, it may be useful to test specific routes to computers in order to verify the various strands of each link group. By using specific port addresses for each switch, rather than link group numbers, you can precisely navigate a route through any part of the system.

To test a specific link

- 1 Simultaneously press and hold **Ctrl** and **Alt**.

Note: **Ctrl** and **Alt** are the standard hotkeys and can be **altered** to avoid clashes with other devices or software. If you change the hotkeys, remember to use the new ones in place of **Ctrl** and **Alt** when following these instructions. For ServSwitch Duo IPC and Wizard IP combinations, please see the extra note below.

- 2 While still holding **Ctrl** and **Alt**, in sequence, press and release the full address of the required computer – remember to use specific port numbers, not link group addresses, e.g. port 01140203.
- 3 When the last digit has been entered, release all keys.

Hotkey clashes between ServSwitch Duo IPC and Wizard IP

When using the Wizard IP in conjunction with the ServSwitch Duo IPC it may be necessary to change the standard hotkeys for one of the devices as they both use **Ctrl** and **Alt** as their standard hotkeys. It is not important which device is **altered**, however, ensure that the new setting does not clash with any software being used on connected computers.



Multiple video head connections

Two or more ServSwitch Duo IPC units can be connected together so that they operate in a synchronised manner. Synchronised operation is useful for applications that require multiple video signals to be switched together. This type of operation is usually required where each computer is fitted with multiple video cards or video cards with multiple video heads. Such configurations are typically required in banking and engineering applications where greater video 'real estate' is required. Whenever the ServSwitch Duo IPC channel is switched it sends an RS232 command out on its serial interface (marked COM on the rear panel). The ServSwitch Duo IPC switches its channel if it receives the same command on its serial interface. Consequently, by linking the serial interfaces, a master unit may be made to automatically switch one or more slave units as shown in the diagram.

It should be noted that the synchronisation cable deliberately does not have the transmit pin of the Slave End connector linked to the receive pin of the Master End connector. To do so would cause the Slave unit to be able to switch the Master unit. This would setup an endless cyclical switching sequence that would prevent the ServSwitch Duo IPC devices from operating correctly. For more details about the serial synchronisation cables, see [Appendix 3](#).

Ensuring that the serial port is available

The ServSwitch Duo IPC has a single RS232 COM port which is used to send/receive configuration data, control power switches and synchronise multiple video head switching. The port can only be used for one of these tasks at any one time. To use the COM port for multiple video head switching, ensure that the [power control option](#) is disabled.

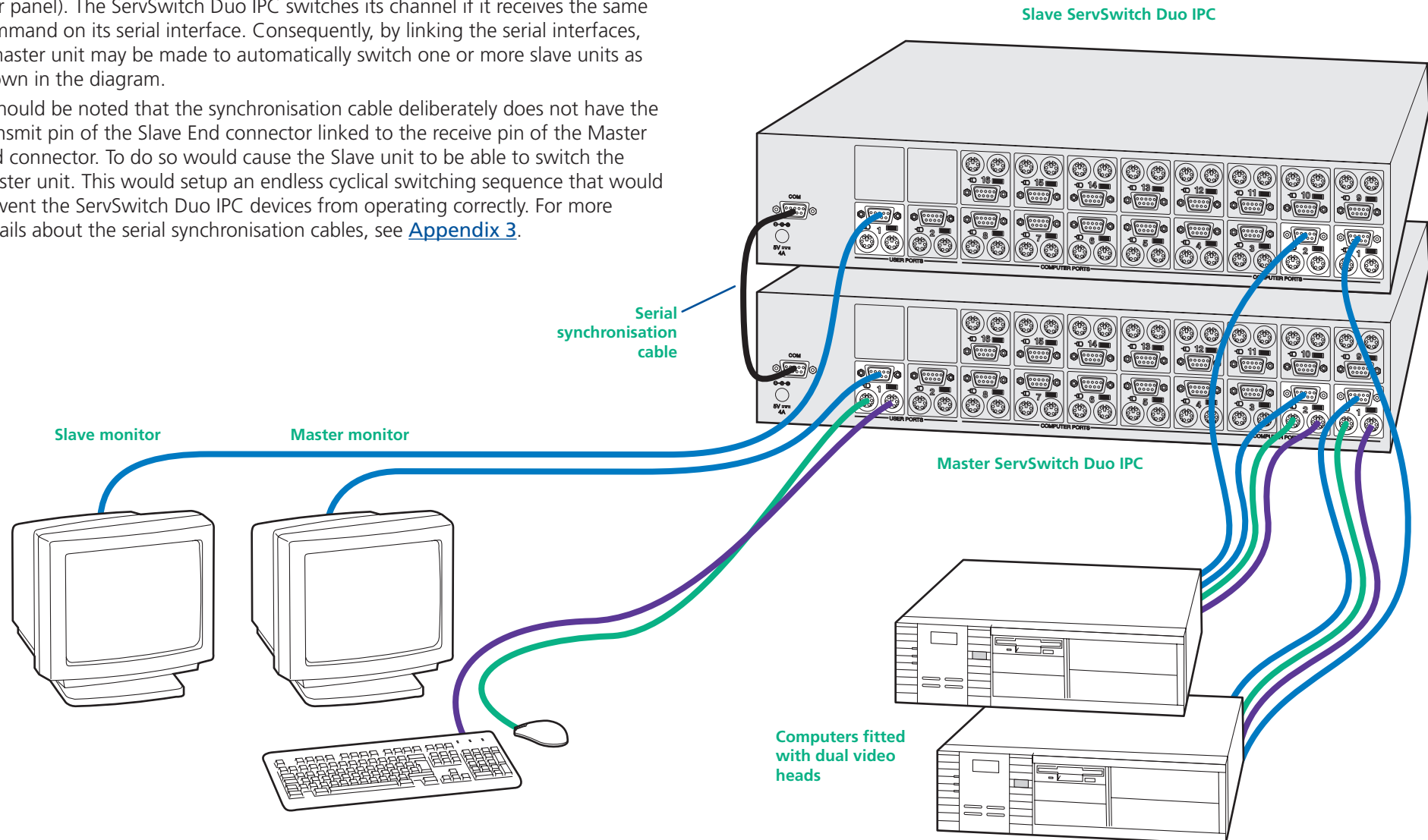

Configuration

Almost all configuration and operational aspects of the ServSwitch Duo IPC are controlled via [on-screen menu](#) displays.

Overall initial configuration

When setting up a new ServSwitch Duo IPC installation, the following stages are recommended:

1 [Enable the 'Security' option within the Configuration menus.](#)

With security disabled (default setting), all users attached to the ServSwitch Duo IPC have full and unrestricted access to all computers and all ServSwitch Duo IPC settings. In larger installations, you are strongly recommended to enable security and set up individual user accounts with access privileges. When also using the Wizard IP, its integral security features provide protection from unauthorised remote users - ensure that its security features are also enabled (please see the Wizard IP user guide for more details).

2 [Create an ADMIN \(administration\) account password.](#)

The ServSwitch Duo IPC has a fixed user account that cannot be deleted, named ADMIN. This user account is the only one that is able to make important system changes. If you intend to use security, then it is important to allocate a password to the ADMIN account.

3 [Create user accounts and allocate access rights.](#)

Use the ADMIN account to add user profiles, passwords and access rights for each of the system users.

4 [Provide names for computers.](#)

When numerous computers are attached, you are strongly advised to provide names for each, to assist with recognition.

5 Configure the required ['Setup Options'](#) and ['Global Preferences'](#)

Use the ADMIN account to determine key ServSwitch Duo IPC settings and timing characteristics.

After all of the above steps are completed, the ServSwitch Duo IPC should be fully configured.

In a hurry?

- If you don't need security (not recommended), *skip steps 1, 2 and 3.*
- If you don't need computer names, *skip step 4*

These steps can be completed at a later date.

When used with an Wizard IP

- **Ensure that security is enabled, follow steps 1 and 2.**
- Unless a locally connected user is required to access the computers, you do not need to create user accounts or provide names for computers - all of this should be carried out on the Wizard IP, *skip steps 3 and 4.*
- Unless a locally connected user is required to access the computers, you do not need to configure Setup Options or Global Preferences, *skip step 5.*



Configuration menus

The configuration menus allow you to determine many aspects of the ServSwitch Duo IPC capabilities. From here you can:

- Create individual user accounts and determine access rights,
- Provide names for all connected computers to allow quick recognition,
- Set individual and global settings for users,
- Run various functions, such as mouse restore operation,
- Save and load ServSwitch Duo IPC configuration settings, and more.

To access the Configuration menu

- 1 If the main menu is not already displayed, press and hold **Ctrl** **Alt** and then press **M** using a keyboard attached to a ServSwitch Duo IPC user port. The main menu will be displayed:

| Computer | Port |
|------------|------|
| Computer 1 | 01 |
| Computer 2 | 02 |
| Computer 3 | 03 |
| Computer 4 | 04 |
| Computer 5 | 05 |
| Computer 6 | 06 |
| Computer 7 | 07 |
| Computer 8 | 08 |

User port 1 Status
ADMIN **SHARED USE**

F1-More menus F3-Find
 Esc-Quit F4-Logout

Annotations:
 - Default names for each computer port (points to Computer 1-8)
 - Identification of this user port (points to ADMIN)
 - Your Login name (points to ADMIN)
 - Port numbers (points to 01-08)
 - Connection status of this user port (points to SHARED USE)
 - Assistance for keypress options (points to F1-F4)

- 2 Press **F1** To display the Configuration Menu:

SERVSWITCH DUO IPC
 Configuration Menu

Functions

- Routing status
- User Preferences
- Global Preferences
- Setup Options
- Edit Computer List
- Edit User List
- Edit Autoscan List
- F1-More menus
- Enter-Select
- Esc-Quit
- Firmware Version 2.08

- 3 Use the **↓** and **↑** keys to highlight an option, then press **↵** to select.

Hotkeys

Note: **Ctrl** and **Alt** are the standard hotkeys and can be **altered** to avoid clashes with other devices or software - in particular, the Wizard IP device when it is used alongside (see below). If you change the hotkeys, remember to use the new ones in place of **Ctrl** and **Alt** when following the instructions in this guide.

Security

Note: If the security option has been enabled, you will be asked for a valid user name and password before the main menu can be displayed (user names and passwords are not case sensitive).

SERVSWITCH DUO IPC

User Name:

Password:

Port 1 login Esc-Scr Save

IMPORTANT: When supplied, ServSwitch Duo IPC has its security features disabled, which means that any attached users have access to all connected computers and all ServSwitch Duo IPC settings. You are strongly recommended to **enable the 'Security' feature** and set an access password for the ADMIN account.

Hotkey clashes between ServSwitch Duo IPC and Wizard IP

When using the Wizard IP in conjunction with the ServSwitch Duo IPC it may be necessary to change the standard hotkeys for one of the devices as they both use **Ctrl** and **Alt** as their standard hotkeys. It is not important which device is **altered**, however, ensure that the new setting does not clash with any software being used on connected systems.

Whereas ServSwitch Duo IPC uses the hotkeys plus **M** to access its menu, the Wizard IP uses the hotkeys plus **C** to summon its menu:

Wizard IP: What you will see if you press the hotkeys plus C if security is enabled ↵ and if it is not ⇔

ServSwitch Wizard IP Logon

Username:

Password:

Return To Host

ServSwitch Wizard IP Control

- Logoff
- Restore Mouse Functions
- Configuration

Access Mode: Shared

Host: Email server

Return To Host



- INSTALLATION
- CONFIGURATION
- OPERATION
- FURTHER INFORMATION
- INDEX

Configuration menus layout

The menu options are arranged as shown here:

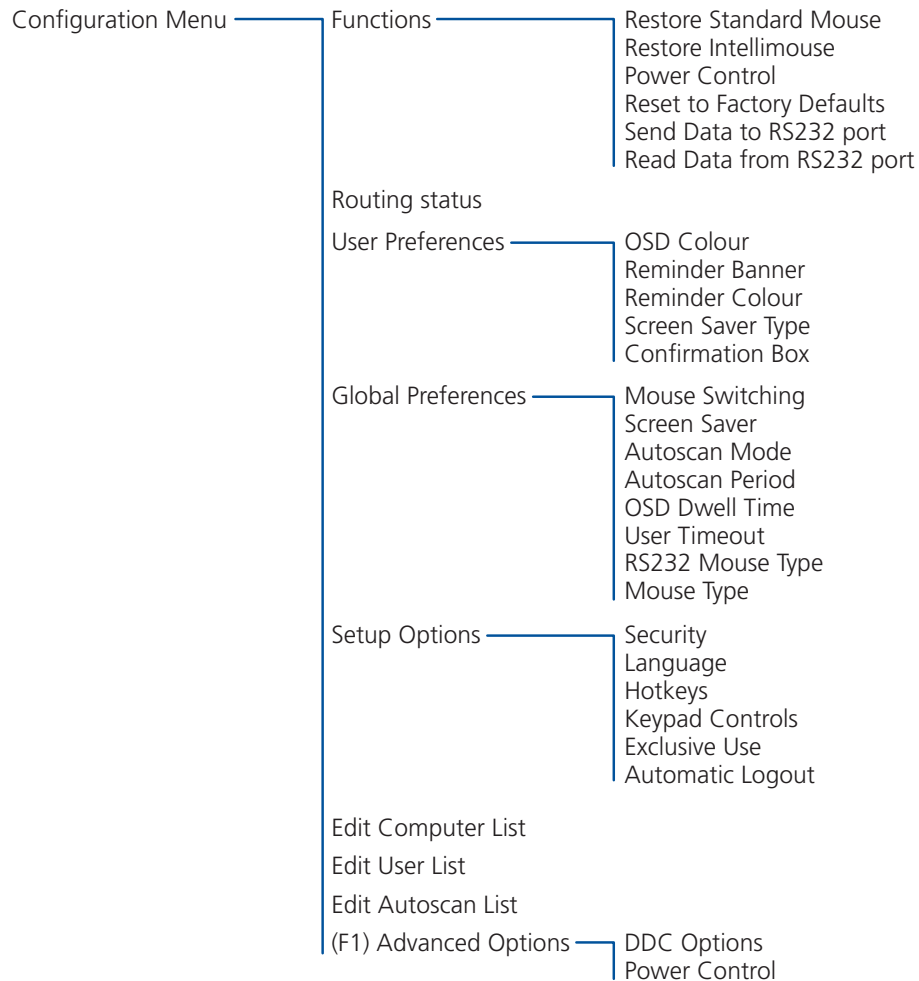

For a description of each option within the Configuration menus, see [Appendix 1](#) for more details.

To enable security

- 1 Display the [Configuration menu](#).
- 2 Highlight 'Setup Options' and press
- 3 Highlight 'Security' and press to select 'ENABLED'.
- 4 Now create a new password for the ADMIN user account.

To set an ADMIN password

- 1 Display the [Configuration menu](#).
- 2 Highlight 'Edit User List' and press .
- 3 Highlight 'ADMIN' and press . Press again to accept the name 'ADMIN' without change.
- 4 Enter an appropriate password for the ADMIN user account with regard to the following:
 - The password can be up to 12 characters long.
 - The password can use letters, numerals and/or certain punctuation marks.
 - The password is not case sensitive.
- 5 Press . The 'Edit Access Rights' menu will be displayed. However, as the ADMIN account always has access to all computers, press again to save the new password.

[What to do if the ADMIN password has been forgotten.](#)

To change the hotkeys







When using the Wizard IP in conjunction with the ServSwitch Duo IPC it will be necessary to change the standard hotkeys for one of the devices. They both use and as their standard hotkeys, so only the first one in the chain (usually the Wizard IP) will respond to your requests. It is not important which device is altered, however, ensure that the new setting does not clash with any software being used on connected computers. The procedure shown here will change the ServSwitch Duo IPC hotkeys, to alter the Wizard IP hotkeys, please see the Wizard IP user guide.

- 1 Display the [Configuration menu](#).
- 2 Highlight 'Setup Options' and press .
- 3 Highlight 'Hotkeys' and press to select the required hotkey combination. The options are: *CRTL+ALT, CTRL+SHIFT, ALT+SHIFT, ALT GR, LEFT ALT+RIGHT ALT, LEFT CTRL+LEFT ALT, RIGHT CTRL+RIGHT ALT or DISABLED.*
- 4 Press to return to the 'Configuration Menu'.







Registering users

To create/edit user accounts







- 1 Display the [Configuration menu](#). *Note: You must be logged-in as the ADMIN user.*
- 2 Highlight 'Edit User List' and press .
- 3 Either:
 - *Create a new account* - Press , enter a new user name and press , or
 - *Edit an existing account* - Highlight the required user name and press . Edit the name, if appropriate, and/or press .
- 4 Enter or edit the password with regard to the following:
 - The password can be up to 12 characters long.
 - The password can use letters, numerals and/or certain punctuation marks.
 - The password is not case sensitive.
 - The password field can remain blank to allow open access to this account.
- 5 Press  to display the 'Edit Access Rights' menu. Here you can determine which of the connected computers can be accessed by the selected user account. Only computers that show the '+' marker to the right of the menu box will be accessible to the user account.

Note: The [Port Direct](#) feature (which allows interconnected KVM switches to talk to one another) ensures that users without access rights to particular computers cannot move sideways to those computers via other computers.





Note: Access rights for user accounts to particular computers can also be controlled from the 'Edit Computer List' menu.
- 6 Select and deselect computers as follows:
 - *Individual computer* - Highlight a computer name, then press  to apply, or remove, a '+' marker.
 - *Access to all computers* – Press 
 - *Access to no computers* – Press 
- 7 When all settings have been made, press  to save and exit. Press  to return to the 'Configuration Menu'.

Registering computers

To create/edit computer entries

- 1 Display the [Configuration menu](#). *Note: You must be logged-in as the ADMIN user.*
- 2 Highlight 'Edit Computer List' and press .
- 3 Either:
 - *Create a new computer entry* – Press  and enter a new name, or
 - *Edit an existing computer entry* – Highlight a computer name and press . Press  (Backspace) to delete existing characters and enter the required new name (up to 16 characters).
- 4 Press  and the cursor will move to the computer port column on the right side. Change or enter the port address of the computer as required. See the [Addressing computers in a cascade](#) section for more details. When the port address is complete, press . The 'Edit access rights' menu will be displayed. Here you can determine which users should have access to the created/edited computer. Only users that show a '+' marker to the right of the menu box will be granted access to the computer.

Note: The [Port Direct](#) feature (which allows interconnected KVM switches to talk to one another) ensures that users without access rights to particular computers cannot move sideways to those computers via other computers.

Note: Access rights for particular user accounts to computers can also be controlled from the 'Edit User List' menu
- 5 Select and deselect users as follows:
 - *Individual user* - Highlight a user name, then press  to apply, or remove, the '+' marker.
 - *Allow access for all users* – Press 
 - *Allow no user access (except ADMIN)* – Press 
- 6 When all settings have been made, press  to save and exit. Press  to return to the 'Configuration Menu'.

Tips when creating/editing computer entries

- Avoid creating two names for the same computer port.
- When cascading to other KVM switch devices, do not apply individual names to any ports that are forming a link group to another switch (i.e. ports 1 and 2 when they form link group 21).



Autoscanning

The ServSwitch Duo IPC provides an autoscan mode that switches between the connected computers in sequence. This mode is useful to allow users and administrators to sample activity among the connected machines. Three scanning modes are provided:

- *Scan list* – Only computers declared within an autoscan list will be viewed. Computers connected to cascaded switches can be included in the autoscan list.
- *Active PCs* – Only computer ports where an active computer is detected will be viewed. This mode avoids blank screens from being displayed and helps to prevent the viewing monitor from entering a power-down state on every scan cycle. Computers connected to cascaded switches will not be viewed in this mode.
- *All PCs* – This mode visits, in turn, each computer that is connected directly to the ServSwitch Duo IPC. This mode should be used with care due to the reasons given in the warning below. Computers connected to cascaded switches will not be viewed in this mode.

The scanning mode is a global setting and hence will be the one viewed by any user who selects **Ctrl** **Alt** **A** on their keyboard. Note, however, that users will only see the scanned computers to which they have access rights. Hence, if two users (with various access rights) simultaneously view an autoscan, they will see differing results depending upon their respective permissions.

WARNING: Many modern monitors are fitted with automatic power saving relays that switch off after a few seconds when connected to an inactive computer. If you are using such a monitor, do not set the ServSwitch Duo IPC to the scan 'ALL PCs' mode. Continual switching on and off of the monitor's relay will eventually damage the monitor. If using such a monitor in conjunction with the 'Scan List' option, ensure that all selected computers are active.

There are up to three steps that need to be configured to use autoscanning ⇔

- *Select the autoscan mode:* Scan List, Active PCs or All PCs.
- *Select the autoscan period.* This is the time that is spent viewing each computer. This step also enables and disables the autoscan feature.
- *Define the autoscan list.* This step is only required when the Scan List option is selected and allows you to select which computers will be scanned.

To select an autoscan mode

- 1 Display the [Configuration menu](#). *Note: You must be logged-in as the ADMIN user.*
- 2 Highlight 'Global Preferences' and press **↓**.
- 3 Highlight 'Autoscan Mode' and press **Space** until the required option is displayed: SCAN LIST, ACTIVE PCs or ALL PCs.

To select an autoscan period

- 1 Display the [Configuration menu](#). *Note: You must be logged-in as the ADMIN user.*
- 2 Highlight 'Global Preferences' and press **↓**.
- 3 Highlight 'Autoscan Period' and press **Space** until the required time to view each computer is displayed, ranging from 2 seconds to 5 minutes.

To define an autoscan list

Note: This stage is required only when the 'Scan List' autoscan mode is selected.

- 1 Display the [Configuration menu](#). *Note: You must be logged-in as the ADMIN user.*
- 2 Highlight 'Edit Autoscan List' and press **↓**. A list of all connected computers will be displayed. Only computers that show a '+' marker to the right of the menu box will be autoscanned.
- 3 Select and deselect computers to scan as follows:
 - Individual computer - Highlight a computer name, then press **Space** to apply, or remove, the '+' marker.
 - Mark all computers for scanning – Press **F1**.
 - Unmark all computers – Press **F2**.
- 4 When all settings have been made, press **↓** to save and exit. Press **Esc** to return to the 'Configuration Menu'.

To view autoscan

- At one of the user ports, press **Ctrl** **Alt** **A**.

*Note: **Ctrl** and **Alt** are the standard hotkeys and can be **altered** to avoid clashes with other devices or software - in particular, the Wizard IP device when it is used alongside. If you change the hotkeys, remember to use the new ones in place of **Ctrl** and **Alt** when following these instructions.*



Saving and restoring configuration settings



The ServSwitch Duo IPC can store up to 512 computer names and 16 sets of user access rights. Particularly in cascaded configurations, manually re-entering all computer names, port numbers and access rights can be a lengthy process. Therefore, the ServSwitch Duo IPC provides a method to save and, if required, restore configuration settings using one of its serial ports. Further to this, the saved file can be opened and edited within a spreadsheet and then restored back to the ServSwitch Duo IPC – a useful way to make multiple setup changes.

Note: You must be logged-in as the ADMIN user for this procedure.

Preparations for configuration save/load

- Contact [Black Box](#) support to obtain the files XPREAD.EXE and XPWRITE.EXE.
- Connect the serial port on the rear panel of the ServSwitch Duo IPC, labelled 'COM', to a serial port on your computer using the optional serial flash upgrade cable available from Black Box. See [Appendix 3](#) for pin-out specifications.
- Ensure that the serial port is available. The ServSwitch Duo IPC has a single RS232 COM port which is used for various functions. The port can only be used for one task at any one time. To use the COM port for configuration saving/loading, ensure that the [power control option](#) is disabled.

To save configuration settings

- 1 Run the program XPREAD.EXE on the computer that is connected to the ServSwitch Duo IPC's serial port. Follow the instructions given by the program.
- 2 Using one of the ServSwitch Duo IPC user ports, display the [Configuration menu](#). *Note: You must be logged-in as the ADMIN user.*
- 3 Highlight 'Functions' and press .
- 4 Highlight 'Send Data to RS232 port' and press .
- 5 The ServSwitch Duo IPC will send the configuration data to your computer. The XPREAD program will store the data in a file named 'XPRODATA.CSV' that will be created in the same directory where the XPREAD program was started - Ensure that you have sufficient rights to write to this directory.

To edit the configuration settings

The saved XPRODATA.CSV file can be opened using a spreadsheet program such as Microsoft Excel. The format of a typical file is shown below. You will see that the computer names (rows) are tabulated against the user profiles (columns):



| USERS | | ADMIN | Alan | Jim | Sue | Test |
|---------------|------|----------|---------|-------|---------|------|
| PASSWORDS | | password | letmein | hello | logmein | Test |
| COMPUTERS | PORT | | | | | |
| Admin PC | 2103 | 1 | 1 | 1 | 1 | |
| Alan's System | 2102 | 1 | 1 | 1 | | |
| Comms Server | 3 | 1 | | 1 | | |
| Comms PC | 4 | 1 | 1 | 1 | 1 | |
| Gateway 1 | 8 | 1 | | | | |
| Gateway 2 | 5 | 1 | | | | |
| Test System | 15 | 1 | 1 | | | |
| Web Browser | 9 | 1 | | 1 | | 1 |

Hints for editing

- To grant a user access to a computer, enter the value '1' in the box that is common to the computer's row and the user's column.
- To deny access, leave the box blank.
- To add extra users, add additional columns (up to 16 users).
- To add extra computers, add additional rows (up to 512 computers).
- The ADMIN user will always be granted access to all computers regardless of the values entered.

To restore configuration settings

Note: Ensure that the computer is connected to the ServSwitch Duo IPC as discussed earlier in the 'Preparations' sub section.

- 1 Copy the program XPWRITE and XPRODATA.CSV into the same directory on the computer connected to the ServSwitch Duo IPC's serial port.
- 2 Run the program XPWRITE.EXE and follow the instructions given by the program.
- 3 Using one of the ServSwitch Duo IPC user ports, display the [Configuration menu](#). *Note: You must be logged-in as the ADMIN user.*
- 4 Highlight 'Functions' and press .
- 5 Highlight 'Read Data from RS232 port' and press .
- 6 The ServSwitch Duo IPC should then receive the configuration data from the computer and load the new menu names and access rights into the menu.



What to do if the ADMIN password has been forgotten

If the ADMIN password becomes mislaid or forgotten, you will not be able to access the ServSwitch Duo IPC to add or edit users and computer names. This situation may be resolved by performing a complete reset to return the ServSwitch Duo IPC to its factory default state.

IMPORTANT: A complete reset erases all the user names and computer names that you have setup. You can only perform a complete reset if you have access to both the front and the rear of the ServSwitch Duo IPC.

To perform a complete reset and return the ServSwitch Duo IPC to its factory default state:

- 1 Power on the ServSwitch Duo IPC normally.
- 2 Whilst the ServSwitch Duo IPC is powered on move switch 2 on the rear panel of the ServSwitch Duo IPC (labelled UPGRADE) to the ON (down) position.
- 3 Press the USER and the COMPUTER keys together.
- 4 The green USER display will show 'R' for a few seconds to confirm that a reset is taking place.
- 5 Return switch 2 to the normal OFF position (up).





Ensuring that the serial port is available for other functions

The ServSwitch Duo IPC has a single RS232 serial port which can be used to:

- Control power switches,
- Send/receive configuration data, and
- Synchronise multiple video head switching.

The port can only be used for one of these tasks at any one time. For the latter two functions to be possible, the Power Control option must be disabled.

To set the serial port for non-power control functions

- 1 Display the [Configuration menu](#). Note: You must be logged-in as the ADMIN user.
- 2 The 'Functions' option should be highlighted, press .
- 3 Press  to display the 'Advanced Options' menu.
- 4 Highlight the 'Power Control' option and press . Check that the 'Power Control' option is 'DISABLED'. If not, highlight it and press  to change it.
- 5 Press  to quit the screen and save the settings.



Hot plugging and mouse restoration

It is strongly recommended that you switch off a computer before attempting to connect it to the ServSwitch Duo IPC. However, if this is not possible then you need to 'hot plug' the computer while it is still running. There is not normally a danger of damage to the computer, however, when mouse communications are interrupted, often they fail to re-initialise when reconnected. The ServSwitch Duo IPC provides a feature to reinstate mouse communications once the necessary connections have been made.

There are two main types of data formats used by current PC mice, these are the older 'PS/2' or 'standard mouse' format and the more recent 'IntelliMouse®' format introduced by Microsoft. These use slightly different data arrangements and it is important to know which type was being used before you hot-plugged the computer to the ServSwitch Duo IPC. The previous setting depends both on the type of mouse and the type of driver, as various combinations of PS/2 and IntelliMouse are possible. Using the incorrect restore function may produce unpredictable results and require the computer to be re-booted.

Which restore setting do I use?

The general rule is that unless both the mouse *and* the driver are *both* IntelliMouse compatible then you need to restore the mouse as 'PS/2'. An IntelliMouse can operate in either mode, whereas a PS/2 mouse cannot.



Recognising an IntelliMouse-style mouse

The IntelliMouse format was introduced to support, among other features, the scroll wheel function. If the mouse has a scroll wheel, then it is likely to support the IntelliMouse format. If it is a Microsoft-branded mouse, then it will usually state that it is an IntelliMouse on its underside label.

Recognising an IntelliMouse driver

Before hot plugging to the ServSwitch Duo IPC (or afterwards using only keyboard control), access the Windows Control Panel of the computer and select either the *Mouse* option (on Windows NT, 2000 and XP) or the *System* option (on Windows 95, 98, ME). Look for the name of the driver, which will usually include the words *PS/2* or *IntelliMouse*.

To restore mouse operation when hot plugging:

- 1 Using a KVM cable set, carefully make the connections between the keyboard, monitor and mouse sockets of the computer and the required ServSwitch Duo IPC port.
- 2 [Select the port](#) of the newly connected computer and then display the [Configuration menu](#).
- 3 Highlight 'Functions' and press .
- 4 As appropriate, highlight one of the following options:
 - *Restore Standard Mouse* – if PS/2 mode is required, or
 - *Restore IntelliMouse* – if IntelliMouse mode is required.Then press .
- 5 Move the mouse a short distance and check for appropriate on-screen cursor movement. If the mouse cursor darts erratically around the screen, then cease moving the mouse. This is an indication that the chosen restore function is incorrect. Try again using the other restore function.

Note: The restore functions predict the likely mouse resolution settings but may not restore the exact speed or sensitivity settings that were originally set.



Resetting user port keyboards and mice

The ServSwitch Duo IPC provides the option to perform a complete power off reset of the keyboard and mouse that are connected to a selected user port. This can be useful if you wish to disconnect the keyboard or mouse and replace them with alternatives. Keyboards will enable themselves automatically if they are disconnected and then re-connected to the ServSwitch Duo IPC. Mice, however, will not normally re-enable themselves after they have been disconnected and re-connected although they will do so automatically if the ServSwitch Duo IPC channel has been changed whilst the mouse is disconnected.

Consequently you will normally need to perform a power-off reset of the user port if you have disconnected and re-connected a mouse. The power off reset function only affects the selected user port and does not affect any of the computer connections or any of the other user ports.

To perform a power-off reset for a selected user port

- 1 Press the USER key on the front panel of the ServSwitch Duo IPC to select the user port whose keyboard and mouse you wish to reset.
- 2 The selected user port number should now be shown on the green USER display.
- 3 Press and hold down the USER key for 5 seconds until the green USER display goes off. The keyboard and mouse will then be powered off.
- 4 As soon as the green display goes off, release the USER key. The green display will then resume and a few seconds later the keyboard and mouse will be powered on, ready for use.

Disabling mouse acceleration

Certain operating systems, such as Windows XP provide an option to use 'mouse acceleration' or 'Enhance pointer precision'. If this option is enabled on a computer connected to the ServSwitch Duo IPC it can cause problems when accessed via a remote IP link (when using the Wizard IP). Generally, the remote mouse pointer becomes erratic and difficult to control. For this reason, you are strongly recommended to disable such features on computers that will be accessed remotely.

To disable mouse acceleration

- 1 On the computer connected to the ServSwitch Duo IPC, access the Mouse driver within the Control Panel.
- 2 Locate and disable the setting variously labelled as 'Mouse acceleration' or 'Enhance pointer precision'.

Note: If a remote computer has mouse acceleration enabled and you need to disable it remotely, then it can be difficult to accurately position the remote cursor. In this case, display the ServSwitch Duo IPC menu (Ctrl Alt M). While it is displayed, you can move the your local cursor to the required screen position and then deactivate the on screen menu.









Power switching configuration

Power switch configuration comprises three main steps:





- Configure the serial port to the same settings used by the power switch boxes.
- Configure a power ON string for each power port.
- Configure a power OFF string for each port.

The procedures used to achieve the latter two steps are almost identical. For each power port there needs to be a valid 'Power ON string' and similarly an appropriate 'Power OFF string'. In each case, the strings are a short sequence of characters that combine a port address and a power on or off value. Where a particular computer has more than one power input (and thus requires an equivalent number of power ports to control them), collections of strings can be associated to switch all of the required ports together as a group.

To configure the power-control serial port

- 1 Display the [Configuration menu](#). *Note: You must be logged-in as the ADMIN user. The settings given below are sample settings - other power switches may require different settings.*
- 2 The 'Functions' option should be highlighted, press .
- 3 Press  to display the 'Advanced Options' menu.
- 4 Highlight the 'Power Control' option and press . Check that the 'Power Control' option is 'ENABLED'. If not, highlight it and press  to change it.
- 5 Check that the 'Baud Rate' entry shows '9600'. If not, highlight it and press  to change it.
- 6 Check that the 'Format' entry shows 'NONE.8.1'. If not, highlight it and press  to change it.
- 7 Press  to quit the screen and save the settings.

To configure the power strings for each computer

- 1 Switch to the computer port whose power port(s) need to be set.
- 2 Display the [Configuration menu](#). *Note: You must be logged-in as ADMIN user.*
- 3 The 'Functions' option should be highlighted, press .
- 4 Highlight 'Power Control' and press .
- 5 Highlight 'Edit Power ON String' and press .
- 6 Edit the power switch string according to the guidelines given overleaf in the [Editing power strings](#) section. If the current computer port requires more than one power port, press  to begin editing the next string for the next associated port. Up to four ports may be grouped in this way.
- 7 Press  to save and exit.
- 8 Repeat steps 5 to 7 for the corresponding 'Edit Power OFF String'.
For details about operating this feature, see [Using remote power switching](#) section within the Operation chapter.





Editing power strings

The string editing screen has two editing areas where you can enter and view the power switch code as either: *ASCII characters* or *HEX values*.

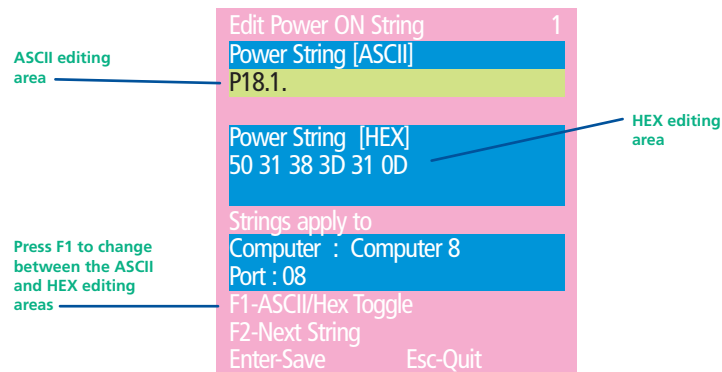

The two areas are linked so that as you change one, the other changes in response. The ASCII edit area has two limitations:

- The ASCII edit area cannot display the '=' character, and represents it with a fullstop when you type '='. However, even though it is not displayed, the character is correctly stored and used.
- You cannot add the 'Enter' character (which is needed at the end of the line) within the ASCII edit box. This must be added within the HEX area, using the code '0D' (zero, not the letter 'O'). The 'Enter' character is also represented in the ASCII area by a fullstop, so the HEX area provides the truest representation of the string contents.

To change between the ASCII and HEX edit areas

- Press **F1**

The structure of power strings

Note: The settings given below are sample settings - other power switches may require different settings. Please refer to [Black Box support](#) for advice on how to configure the ServSwitch Duo IPC to control other power switches.

The ASCII structure of each string (OFF and ON) is as follows:

Pxy=z ↵

Where:

- x** is the switch box number,
- y** is the power port number,
- z** is '0' for OFF or '1' for ON, and
- ↵ is the Enter (or Carriage return) character (0D in Hex).

Example 1

To switch ON port 5 of switch box 2, the ASCII and HEX codes would be as follows:

- ASCII string: P25=1 ↵
- HEX characters: 50 32 35 3D 31 0D

Example 2

To switch OFF port 8 of switch box 3, the ASCII and HEX codes would be as follows:

- ASCII string: P38=0 ↵
- HEX characters: 50 33 38 3D 30 0D

ASCII characters and equivalent HEX codes

The table given here shows the various ASCII characters that you will need along with their HEX equivalents:

| ASCII | Hex |
|-------|-----|
| P | 50 |
| 1 | 31 |
| 2 | 32 |
| 3 | 33 |
| 4 | 34 |
| 5 | 35 |
| 6 | 36 |
| 7 | 37 |
| 8 | 38 |
| = | 3D |
| Enter | 0D |

*Note: Remember, you cannot add the 'Enter' command within the ASCII area, you must change to the HEX area (using **F1**) and type the equivalent code '0D'.*

Creating power port groups

Where multiple power inputs to a server require simultaneous switching, up to four ports can be formed into a power port group.

To add/edit further power strings in order to switch extra ports

- 1 Edit the first power ON string as described above.
- 2 Press **F2** to edit an additional power ON string. Input the appropriate switch box number and port address for the next power port.
- 3 Repeat step 2 for each power port that must be simultaneously switched.
- 4 Repeat all of these steps for the corresponding power OFF strings.

Note: The second, third and fourth strings are actually sent in quick succession. If required, this feature could be used to create one long string for a single port.

Logging access activity

By connecting the ServSwitch Duo IPC's serial port to a computer, a time stamped log of the ServSwitch Duo IPC's activity can be generated. This is useful for applications where it is necessary to keep track of which users have accessed which computers. A simple data logging program, called XPLOG.EXE, may be obtained from [Black Box support](#). This enables the activity log to be saved to a file or printed to a printer. This logging program uses the Excel-compatible file XPRODATA.CSV to cross reference the port and user information to computer and user names in order to generate an informative activity log.

To make use of the activity logging features

- 1 Obtain the program XPLOG.EXE from [Black Box support](#).
- 2 Follow the instructions in the section [Saving and restoring configuration settings](#) to create the Excel compatible file XPRODATA.CSV that contains a list of user and computer names and port numbers.
- 3 Copy the XPRODATA.CSV file into the same directory as the XPLOG.EXE file.
- 4 Run the XPLOG file using the following command format:

```
XPLOG {activity_log_destination} {com_port}
```

where:

- {activity_log_destination} is the file name where the log is to be stored or the word PRINT if the log is to be printed on a printer attached to the computer's parallel port. LPT1
- {com_port} is the computer's serial port that is connected to the ServSwitch Duo IPC. Options are 1 (for COM1) or 2 (for COM2).

For example:

- XPLOG datalog.txt 1
would log activity information received on COM1 to the file datalog.txt.
- XPLOG PRINT 2
would print activity information received on COM2 to the printer attached to the computer's LPT1 printer port.

These programs will run continuously until you press .

More information

If you wish to integrate activity data logging with your own applications, contact [Black Box support](#) for a list of serial data logging codes and their associated meanings. It is possible to use the activity logging and ServSwitch Duo IPC synchronisation features together but this requires a specially constructed serial cable. Please contact Black Box for further details.









Display Data Channel (DDC)

The industry standard *Display Data Channel* feature allows the ServSwitch Duo IPC to discover the capabilities of a user port video monitor and transmit that information to the connected computers. This helps to reduce incidents where too high a video resolution/frequency signal is sent to the user port by a selected computer, resulting in an unreadable or blank screen image. For successful operation, it does require that the computers and their video circuitry are configured to respond to DDC information.

When using two monitors of different capabilities

The DDC feature can use only one set of monitor specifications in its declarations to the connected computers. This becomes an issue when the monitors connected to the two user ports have different capabilities, e.g. a 15" VGA monitor on user port 1 and a 17" multiscan monitor on user port 2. In such cases, it is important to ensure that the ServSwitch Duo IPC samples the lower specified of the two monitors.

To configure DDC settings

- 1 Press    to select the on-screen menu.
- 2 Press  to select 'More menus', then press  again to select the next level of 'More menus'.
- 3 Highlight *DDC Options* and press .
- 4 Ensure that the *DDC Function* option is set to ENABLED. If not, highlight it and press  to change its setting.
- 5 Choose the *DDC Source*. Highlight this option and press  to specify a particular user port, or choose AUTO - this begins with user port 1 and moves to the other port if a valid DDC monitor is not found.

Note: Where the two connected monitors have different capabilities, ensure that the DDC Source option is set to look only at that port.

- 6 Choose an appropriate *DDC Refresh* setting. The setting AT START will interrogate the monitor(s) selected in the *DDC Source* option whenever the ServSwitch Duo IPC is switched on. When DISABLED, no new DDC data is sought and existing information is used. When viewing this menu, press F8 to perform a discover DDC information from the chosen user port immediately.



Port Direct

Port Direct is a totally transparent communication system that allows compatible KVM switches and remote access devices to communicate with each other.

Using the keyboard connections that link each device, Port Direct allows:

- A controlling device to provide address details of the required port, the user's name and access rights, mouse calibration and video mode information.
- A controlled device to confirm the address and other details of the current port.

Such communication simplifies both the configuration and selection of systems within a complex cascade structure. It also provides excellent security control as unauthorised users are prevented from achieving what is sometimes possible on simpler KVM switching systems. That is, to use the hotkey and mouse switching features to connect to servers for which they do not have access privileges via the on-screen menu. This is termed 'sideways movement' and is thwarted by the Port Direct feature because each unit is fully informed of each user's precise access rights.

Devices that support Port Direct include the ServSwitch Duo IPC, the Wizard IP and certain KVM switch devices from other manufacturers with specific Port Direct capabilities.



INSTALLATION

CONFIGURATION

OPERATION

FURTHER
INFORMATION

INDEX

Operation



Powering on

The ServSwitch Duo IPC does not have a power switch, so whenever power is applied via the supplied adapter, the unit is operational. A green indicator on the front panel (labelled 'Power') shows power input status.

Note: Before applying power to the ServSwitch Duo IPC, ensure that the two option switches at the rear panel are both set to the OFF (up) position.

The front panel controls

The ServSwitch Duo IPC front panel provides a range of buttons, indicators and connectors.

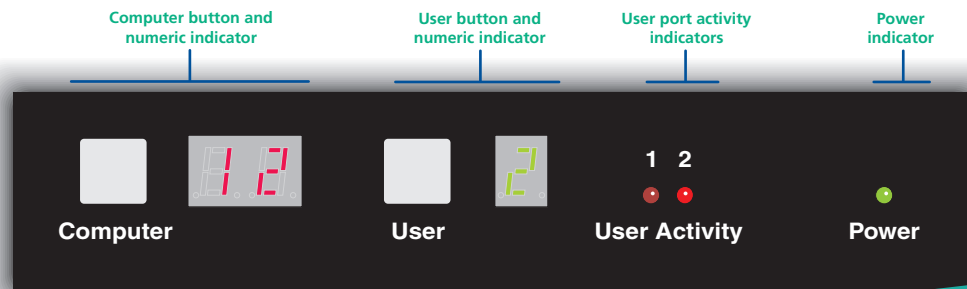

Computer button and numeric indicator

These items allow you to select any one of the ServSwitch Duo IPC's computer ports. As the button is pressed, the number shown by the red numeric indicator will increment to the next available computer channel. The computer port selected will then be connected to the user port that is currently chosen by the adjacent user button and green numeric indicator.

User button and numeric indicator

These items allow you to select either of the ServSwitch Duo IPC's two user ports. With each press of the button, the number displayed by the green numeric indicator will change between port 1 and port 2. At the same time, as each user port number is displayed, the computer port that is currently associated with that port will be indicated by the red numeric indicator.

User port activity indicators

These two red indicators provide confirmation that keyboard and mouse activity is being detected from each of the two user ports.

Power indicator

Glows green whenever power is applied to the ServSwitch Duo IPC.

Using the ServSwitch Duo IPC

Selecting a computer

Note: When the ServSwitch Duo IPC is used in conjunction with a Wizard IP (and security is enabled), the ServSwitch Duo IPC will automatically enter a slave mode. In slave mode, the on-screen menu, hotkeys and mouse button switching are unavailable to all users connected via the Wizard IP, except the admin user. Users connected locally to the ServSwitch Duo IPC can continue to use the switching methods described here.

There are four main ways to connect a particular user port to a specific computer port:

- Using the front panel controls (discussed below) – this is a straightforward method, if the ServSwitch Duo IPC is nearby.
- Using the on-screen menu (shown right) – this is the best method when there are many connected computers.
- [Using hotkeys](#) – this is a good method if you continually access a small number of computers.
- [Using mouse buttons](#) – this is a good method for switching between a small number of computers.

For all methods (if the [confirmation box option](#) is enabled), when the required port is selected, a pop up message will be displayed to confirm the port connected to, and its status. Alternatively, an error message explaining why a connection is not possible (press **Esc** to cancel the latter type of message).

To select a computer using the front panel controls

Note: It is possible for the front panel controls to be limited to selecting only the on screen menu or a blank screen. If this is the case please use a different switching method or contact your system administrator for details.

- 1 Press the User button until the green numeric indicator displays the port number to which your keyboard, video monitor and mouse are connected.
- 2 Press the Computer button until the red numeric indicator shows the required computer port number.

Note: If security has been enabled then only computer ports to which the current user port has permission will be displayed.

As well as the sixteen (or eight) standard computer ports, there are also two additional special ports that appear after port 16 and before port 1:

- 🔒 This port provides no video signal so that a connected power saving monitor will be prompted to enter into its power saving mode.
- 🖱️ This port connects the current user port to the on-screen menu.

To select a computer using the on-screen menu

- 1 Select the on-screen menu in one of three ways:

- By simultaneously pressing and then releasing **Ctrl** **Alt** **M**.

Note: The **Ctrl** and **Alt** keys when pressed in combination are called 'hotkeys' and they signal to the ServSwitch Duo IPC that you wish to control it, rather than the computer. However, if these particular hotkeys clash with another device or program, then your administrator may change them to a different combination. If the **Ctrl** **Alt** **M** combination fails to work, then please contact the system administrator for details.

- By pressing the middle and right buttons of a three button mouse, or
Note: The mouse switching option is usable only if the Mouse switching option is enabled. See [Global preferences](#) for more details.

- By selecting port **🖱️** using the front panel buttons (see previous).

At this point, depending on the security settings and the current log in situation, one of two things will be displayed, either the login screen, or the Selection menu:



The login screen - here you enter a valid User Name and Password – see [Logging in and out](#) for more details. When you do so, the ServSwitch Duo IPC selection menu will be displayed:

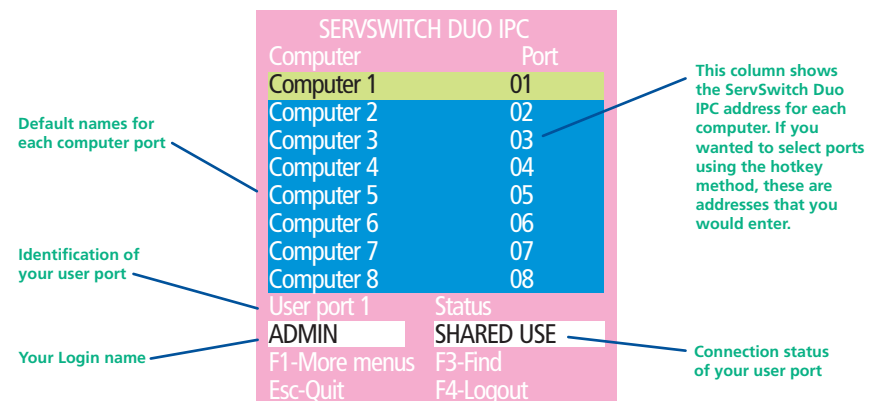

The Selection Menu – here you can select computers by name.



- Use the and keys (or the scroll wheel of an IntelliMouse) to highlight the required computer name. Alternatively (for large configurations), press to perform an alphabetical search for a particular port name.

Note: If security has been enabled then only computer ports to which the current user port has permission will be displayed.

- Select the highlighted port in one of three ways:
 - Shared use* - press - This *standard* method allows other users to view the same computer port. Control of the port is given to one user at a time, on a first-come, first-served basis and is relinquished after a certain period of inactivity.
 - Exclusive use* - press - This mode prevents any other user from viewing or controlling the computer port until you either select another computer or log off. This mode should be used with care – it can also be blocked as an option by the administrator.
 - Video Only* - press - This mode displays the video picture of the port, but prevents keyboard or mouse activity from controlling the computer.

To select a computer using hotkeys

- 1 Simultaneously press and hold and .

Note: The and keys when pressed in combination are called 'hotkeys' and they signal to the ServSwitch Duo IPC that you wish to control it, rather than the computer. However, if these particular hotkeys clash with another device or program, then your administrator may change them to a different combination. If the combination fails to work, then please contact the system administrator for details.

- 2 While still holding and , press the first numeral of the required port address, then:
 - If the port address is a single character, release all of the keys.
 - If the port address is two or more characters, release the first numeral key and press the second – repeat this procedure until all of the port address numerals have been entered, then release and .

Note: The numbers on your keyboard's numeric keypad are not valid, use only the numeral keys above the QWERTY section.

Note: If your user port does not have authorisation to view the selected port then an 'Insufficient user rights' messages will be displayed.

Standard hotkeys

The range of hotkey combinations are as follows:

Note: If your hotkeys have been changed, substitute them for and in the examples given here.

| | |
|-----------|--|
| 1 | Selects port 1 |
| 2 | Selects port 2 |
| • | • |
| • | • |
| 1 then | Selects port 10 |
| • | • |
| 1 then | Selects port 16 |
| Tab | Selects the next available port |
| A | Selects autoscan mode where each (authorised) port is displayed for a period determined by the administrator. To cancel autoscan mode, simply select any fixed channel using any of the suggested methods. |
| 0 | Switches off the video signal – this will cause a power saving monitor to enter its standby mode. To awaken the monitor, simply select any fixed channel using any of the suggested methods. |
| L | Logs out the current user (if security is enabled) or selects port 0 to disable the video signal (if security is disabled). |
| & , , or | Moves the currently displayed on-screen menu around the screen. |

To select a computer using mouse buttons



Note: This procedure works only with three-button or IntelliMouse devices and only if the 'Mouse Switching option' has been enabled by your administrator.

- 1 Hold down the middle button (or scroll wheel) of the mouse.
- 2 Click the left mouse button to select the next computer port. When the correct port is reached, release the middle button.

Note: If security has been enabled then only computer ports to which you have permission will be displayed.



To select a computer using mouse buttons – Advanced method

- 1 Select the on-screen menu by pressing the middle and right buttons of a three button mouse.
- 2 Use the scroll wheel to highlight the required computer port.
- 3 Then, select either:
 - *Shared Use* - press the left mouse button - This *standard* method allows other users to view the same computer port. Control of the port is given to one user at a time, on a first-come, first-served basis and is relinquished after a certain period of inactivity.
 - *Exclusive Use* - press  and the left mouse button – This mode prevents any other user from viewing or controlling the computer port until you either select another computer or log off. This mode should be used with care – it can also be blocked as an option by the administrator.
 - *Video Only* - press  and the left mouse button – This mode displays the video picture of the port, but prevents keyboard or mouse activity from controlling the computer.
 - *Escape without selecting a port* – press the right mouse button.

Logging in and out

The ServSwitch Duo IPC features a straightforward security system that helps to prevent unauthorised access to some, or all connected computers.

Note: If a Wizard IP is fitted and you are a remote IP user, then a separate IP login and password are required in addition to (and in advance of) these details – see [Logging in and out](#) for more details.



If the security option has been selected by your administrator then you will be asked to enter a User Name and Password when you first access a user port. When you have finished using the computer, it is then good practice to logout, forcing any other users to authenticate themselves prior to use.

Note: If the security option has not been enabled then no login is required.

To log in to the ServSwitch Duo IPC

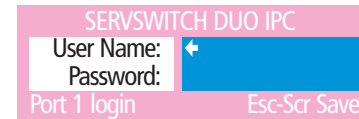





- 1 If it is not already displayed, move the mouse or press any key to display the log in screen.



- 2 Enter your designated User Name and press .
- 3 Enter your designated Password and press . If both entries are correct then the selected port will be displayed.

Note: If either the User Name or Password are incorrect, the entries will be cleared to allow another attempt.

To log out from the ServSwitch Duo IPC

- 1 Select the on-screen menu in one of three ways:
 - By simultaneously pressing and then releasing   .
 - Note: The  and  hotkeys may have been changed. If the combination fails to work, then please contact the system administrator for details.*
 - By pressing the middle and right buttons of a three button mouse, or
 - By selecting port  using the front panel buttons

- 2 Press . The login window will be displayed.

Alternatively:

- Press   and  at any time to log out.



Selecting cascaded computers

The ServSwitch Duo IPC is not limited to sharing just sixteen (or eight) computers. By joining numerous ServSwitch Duo IPC products together in a tree-like or [Cascade](#) arrangement, it is possible for each user port to view many more computers. Although you can use exactly the same selection methods to choose any computer, you are strongly recommended to use the on screen menu method for the following reasons:

- The [on screen menu](#) – this method displays the names of each computer in alphabetical order and also allows you to search for them by name, press **F3** – a useful feature in a long list. This really is the best way to access a large number of computers.
- The [mouse method](#) – this method is fine for small numbers of computers but can take too long to reach the required computer in an extensive configuration.
- The [hotkey method](#) – depending on their position within the connection structure, each computer can have an address up to eight digits long which can be difficult to remember and lengthy to type.

The confirmation box

The ServSwitch Duo IPC provides the option of a confirmation box that is displayed on screen for three seconds after a computer is selected. The confirmation box indicates the current user port and your user name, the selected computer and the connection status. You can enable or disable the confirmation box, as required.

| Computer | Port |
|-------------|------------|
| Computer 1 | 01 |
| User port 1 | Status |
| ADMIN | SHARED USE |

To enable/disable the confirmation box

- 1 Select the on-screen menu in one of three ways:
 - By simultaneously pressing and then releasing **Ctrl**, **Alt**, **M**.
 - By pressing the middle and right buttons of a three button mouse, or
 - By selecting port **F** using the front panel buttons

If you are not already [logged in](#), do so now.

- 2 Press **F1** to select 'More menus'.
- 3 Highlight the 'User Preferences' option and press **↓** to select.
- 4 Highlight the 'Confirmation Box' option and press **Space** to select 'ENABLED' or 'DISABLED', as required.
- 5 Press **Esc** to save the settings. Press **Esc** twice more to return to the computer port and view your changes.

The reminder banner

As many computer screen layouts can appear very similar, the ServSwitch Duo IPC provides a reminder banner option that indicates which computer port you are currently viewing. The banner is usually displayed at the top of the screen, using blue lettering and transparent background. You can:

- Move the banner
- Change the banner colours, and/or
- Disable the banner

To move the reminder banner

- 1 While viewing a computer port, press and hold **Ctrl** and **Alt**.

*Note: The **Ctrl** and **Alt** hotkeys may have been changed. If the combination fails to work, then please contact the system administrator for details.*

- 2 Press the **↓**, **↑**, **←** and **→** keys to move the banner to the required position.

To change banner colours or disable the banner

- 1 Select the on-screen menu in one of three ways:

- By simultaneously pressing and then releasing **Ctrl**, **Alt**, **M**.
- By pressing the middle and right buttons of a three button mouse, or
- By selecting port **F** using the front panel buttons

If you are not already [logged in](#), do so now.

- 2 Press **F1** to select 'More menus'.
- 3 Highlight the 'User Preferences' option and press **↓** to select.
- 4 Select the required option:
 - To disable the banner – highlight 'Reminder Banner' and press **Space** until 'DISABLED' is shown.
 - To change colours – highlight 'Reminder Colour' and press **Space** until the desired colour combination is displayed.
- 5 Press **Esc** to save the settings. Press **Esc** twice more to return to the computer port and view your changes.





Routing status

On occasions it may be useful to know which computers are being accessed, in which modes and by whom. The most common reason for this would be if you were denied access to a computer port and needed to find out if another user has selected 'Exclusive' access. For this purpose the ServSwitch Duo IPC provides the very handy Routing status feature which provides an 'at a glance' view of all current user connections.

To use the Routing status feature



1 Select the on-screen menu in one of three ways:

- By simultaneously pressing and then releasing   .

Note: The  and  hotkeys may have been changed. If the combination fails to work, then please contact the system administrator for details.

- By pressing the middle and right buttons of a three button mouse, or
- By selecting port  using the front panel buttons

If you are not already [logged in](#), do so now.

- 2 Press  to select 'More menus'.
- 3 Use  or your mouse scroll wheel to highlight the 'Routing status' option.
- 4 Press  or the left mouse button to select. The Routing status screen will be displayed where you can instantly see which computer ports are being accessed and by whom. The screen will be displayed for ten seconds.

| Routing Status | |
|----------------|--------------------|
| User 1 | : ADMIN |
| Computer | : Internet Gateway |
| Port: 4109 | EXCLUSIVE USE |
| User 2 | : SAM |
| Computer | : Technical Server |
| Port: 16 | SHARED USE |
| User 3 | : NO USER |
| Computer | : |
| Port: 00 | NOT CONNECTED |
| User 4 | : NO USER |
| Computer | : |
| Port: 00 | NOT CONNECTED |
| Esc-Quit | |

User preferences and functions

In addition to customising the reminder banner as described earlier, you can also:

- Change the colour of the on screen menu,
- Select the screen saver style,
- Restore mouse operation, or
- Perform power control functions.

All of these options are discussed within [Appendix 1](#).



Using power switching

When used in conjunction with optional power switch boxes, the ServSwitch Duo IPC allows you complete remote control over the connected computers. The primary function of the power switching option is to remotely power down and reset computers that are failing to respond.

To switch a computer on or off

1 Select the on-screen menu in one of three ways:

- By simultaneously pressing and then releasing   .

Note: The  and  hotkeys may have been changed. If the combination fails to work, then please contact the system administrator for details.

- By pressing the middle and right buttons of a three button mouse, or
- By selecting port  using the front panel buttons

If you are not already [logged in](#), do so now.

2 Switch to the computer port that needs to be switched on or off.

Note: If the computer is still responding, try to shut it down normally before attempting a power switch operation.



3 Display again the on screen menu and press  to select 'More menus'.

4 The 'Functions' option should be highlighted, press .

5 Highlight 'Power Control' and press .

6 Highlight either 'Switch Computer ON' or 'Switch Computer OFF' as necessary and press . A warning message with two options will be displayed:

| SERVSWITCH DUO IPC | |
|----------------------------|-----------------|
| Power Control | |
| Switch Computer ON | |
| Switch Computer OFF | |
| Edit Power ON String | |
| Edit Power OFF String | |
| Connected to | |
| Computer | : Computer 8 |
| Port : 08 | OFF |
| Are you sure? | |
| Press F8 to confirm | |
| Press F9 to confirm + exit | |
| ↑-Up | ↓-Down Esc-Quit |

7 Press  to confirm or  to confirm and exit. The latter option clears the menu so that, if required, you can be ready to enter any escape sequences that are needed by the computer (to access its BIOS setup area), during the bootup sequence.



Further information



This chapter contains a variety of information, including the following:

- Troubleshooting - see below
- Getting assistance - see right
- Appendices
 - Appendix 1 - [Configuration menu items](#)
 - Appendix 2 - [Firmware upgrade](#)
 - Appendix 3 - [Cable and connector specifications](#)
- [Other products in the ServSwitch Duo IPC range](#)
- [Safety information](#)
- [Warranty](#)
- [Radio frequency energy statements](#)

Troubleshooting

Poor video quality with smearing, fuzziness or ripple

- Use coaxial video cables to connect your devices to the ServSwitch Duo IPC.

When power switching, the selected computer does not power on or off

- Check the power switch port(s) to which the computer is connected. Check the indicator status for that/those ports on the power switch front panel - do they illuminate/extinguish when the switching command is sent?
- If a multi-feed server is attached to more than one power port, check that all of the power inputs are connected to ports and that all those ports are being switched.

For information regarding remote connection problems (when using a Wizard IP), please refer to the Troubleshooting section within the Wizard IP user guide.

Getting assistance

If you are still experiencing problems after checking the list of solutions in the Troubleshooting section then we provide a number of other solutions:

- **Email** in the US: **techsupport@blackbox.com**
 in the UK: **techhelp@blackbox.co.uk**
- **Phone** in the US: **724-746-5500**
 in the UK: **+44 (0)118 965 6000**

INSTALLATION

CONFIGURATION

OPERATION

FURTHER INFORMATION

INDEX

Appendices

Appendix 1 – Configuration menu items





The following configuration menus are available within the configuration section of the ServSwitch Duo IPC:

- *Setup Options* - see below
- [Global Preferences](#)
- [User Preferences](#)
- [Functions](#)
- Advanced Options







Setup Options

Setup options are available only to the Admin user and consist of key settings that are normally made only during the initial installation stage.

To access Setup Options:

- 1 Select the on-screen menu in one of three ways:
 - By simultaneously pressing and then releasing   .
 - By pressing the middle and right buttons of a three button mouse, or
 - By selecting port  using the front panel buttons.

If you are not already logged in, do so now. [What to do if the ADMIN password has been forgotten.](#)

- 2 Press  to select 'More menus'.
- 3 Highlight 'Setup Options' and press .
- 4 Use the following keys:
 -  and  to highlight required options.
 -  to change option values.
 -  to quit and save the changes.

| SERVSWITCH DUO IPC | |
|--------------------|----------|
| Setup Options | |
| Security : | ENABLED |
| Language : | ENGLISH |
| Hotkeys : | CTRL+ALT |
| Keypads Controls : | ENABLED |
| Exclusive Use : | ALLOWED |
| Automatic Logout : | DISABLED |

Space-Toggle
↑-Up ↓-Down Esc-Quit

Security

Settings: *DISABLED, ENABLED*

With security disabled there is no requirement for users to log-in to the system. All users have full access to all the connected computers and full administration rights. With security enabled, users are required to log-in to the ServSwitch Duo IPC. Each user is allocated access rights to computers by the system administrator and they are only able to see the computers that they have access to on their on-screen menu.

Language

Settings: *ENGLISH, FRENCH, GERMAN, SWEDISH*

This option specifies the language that is used for the on-screen menu and the keyboard layout that is assumed for the keyboard. When the French option is selected the keyboard is assumed to have an AZERTY format. When the English, German and Swedish options are selected the keyboard is assumed to have a QWERTY format. The new language settings are enabled when you quit from the SETUP OPTIONS menu. The language option only affects the way that the ServSwitch Duo IPC interprets the keyboard keys, it does not affect the way that the computers interpret the keyboard. It is advisable to avoid setting a language that you do not understand as all the menus will change to use the new language and you may have difficulty reselecting your original language.

Hotkeys

Settings: *CRTL+ALT, CTRL+SHIFT, ALT+SHIFT, ALT GR, LEFT ALT+RIGHT ALT, LEFT CTRL+LEFT ALT, RIGHT CTRL+RIGHT ALT, DISABLED*

The keyboard hotkeys are special combinations of keys that, when used together with certain keyboard "command keys", perform special ServSwitch Duo IPC functions. For example, pressing the hotkeys together with the "M" key will cause the on-screen menu to be displayed on your monitor. Other hotkey combinations allow you to query which computer you are connected to and to move the on-screen menu around the screen. You can also use the hotkeys together with the port number to select a particular connected computer.

Note: When the ServSwitch Duo IPC is used in conjunction with the Wizard IP, it is vital that they do not use the same hotkeys as the latter will prevent any such keypresses from reaching the ServSwitch Duo IPC.

Keypads Controls

Settings: *ENABLED, DISABLED*

The key controls on the front of the ServSwitch Duo IPC may be disabled so that it is only possible to select the special channels "o" and "0" (the on-screen menu and the non-existent channel zero).



Exclusive Use

Settings: *ALLOWED, DISABLED*

In normal operation, the ServSwitch Duo IPC will allow two or more users to share access to a computer. In this mode, the computer's video picture will be displayed on all the user's monitors but only one user may have active control of the computer's keyboard and mouse at any one time. The ServSwitch Duo IPC detects an active user by looking for keyboard and mouse data.

A user becomes inactive if no keyboard or mouse data has been received by the ServSwitch Duo IPC for a specified timeout period. Whilst one user is active all the other users that are connected to the same computer will see a "video only" message displayed on their screen. There may be situations where particular users want to be able to control and view their computers in private with exclusive use. The ServSwitch Duo IPC has the facility to allow users to select exclusive use of computers but this facility should be used with care. When exclusive use is requested the video from the selected computer is only available to the user with exclusive access.

Users that have selected exclusive access are never timed out by the ServSwitch Duo IPC and so all other users are effectively "locked out" until the exclusive user switches to another computer or logs out. This could potentially be very irritating if a user has selected exclusive use and has then left their desk without logging out. This would prevent other users from working on the computer until they came back. Consequently the system administrator can disable all exclusive use so that all connections are shared.

Automatic Logout

Settings: *DISABLED, ENABLED*





The ServSwitch Duo IPC enables you to restrict access to your computers on a login basis. If a user forgets to logout when they have finished accessing the ServSwitch Duo IPC then the user console may unintentionally be left with full access to all the computers. The ServSwitch Duo IPC may be set to automatically logout unattended user consoles when the screen saver kicks in. This reduces the risk of security problems by preventing user consoles remaining in a permanent "logged-in" state when there is no keyboard or mouse activity. The automatic logout feature is only enabled when the screen saver feature is active (i.e. not disabled).

Global Preferences

Global preferences are available only to the Admin user and allow settings to be made that affect all users attached to the ServSwitch Duo IPC.

To access Global Preferences:

1 Select the on-screen menu in one of three ways:

- By simultaneously pressing and then releasing   .
- By pressing the middle and right buttons of a three button mouse, or
- By selecting port  using the front panel buttons

If you are not already [logged in](#), do so now. [What to do if the ADMIN password has been forgotten.](#)

2 Press  to select 'More menus'.

3 Highlight 'Global Preferences' and press .

4 Use the following keys:

 and  to highlight required options.

 to change option values.

 to quit and save the changes.

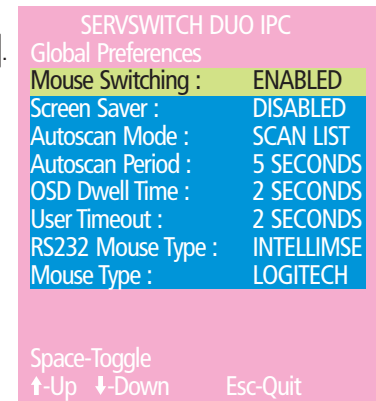

Mouse Switching

Settings: *ENABLED, DISABLED*

Like most advanced KVM switches, the ServSwitch Duo IPC's channel may be switched using a three button mouse or IntelliMouse. Pressing the central button or wheel button together with the left hand mouse button will cause the ServSwitch Duo IPC to switch to the next available computer. When mouse switching is enabled the central mouse button or wheel mouse button is allocated to control the ServSwitch Duo IPC and is not therefore available for use by computer applications. If you want to use the central mouse button within your applications you will need to disable mouse switching. The rotation action of an IntelliMouse wheel is not affected and is always available to the computer application.



Screen Saver

Settings: *DISABLED; 2, 5, 7, 10, 15, 20 & 30 MINUTES*

To avoid burning out the phosphor on CRT monitor screens, the ServSwitch Duo IPC can be set to blank the screen after no keyboard or mouse activity has been detected for a selected timeout period. If preferred, the user can blank the screen manually by selecting channel '0' using the keyboard hotkeys or by pressing ESC from the login screen.

Autoscan Mode

Settings: *SCAN LIST, ACTIVE PCs, ALL PCs*

The ServSwitch Duo IPC supports an autoscan mode that automatically scans between the connected computers in sequence. The ServSwitch Duo IPC supports three autoscan modes. In the first mode the ServSwitch Duo IPC will scan all the named computers that are defined in the autoscan list (SCAN LIST). The computers defined in the scan list may be connected to cascaded ServSwitch Duo IPCs. If you wish to scan the ports on the current ServSwitch Duo IPC then you may select ALL the available computers or just the available computers that are currently powered on (the ACTIVE computers). Scanning just the active computers avoids blank screens from being displayed and stops the monitor from going into a power down state on every scan cycle.

WARNING - Many modern monitors are fitted with automatic power save relays and will switch off after a few seconds if connected to an inactive PC. If you are using such a monitor you must not set the ServSwitch Duo IPC to scan ALL ports. Constant switching on and off of your monitor's relay will eventually damage your monitor. If you are using the SCAN LIST option then you should ensure that all the computers are active if you are using one of these monitors.

If you choose to use the SCAN LIST option then you may define the computers to be scanned in the following manner.

To define the autoscan list

Note: Ensure that you are [logged in](#) as the ADMIN user.

- 1 From the main on-screen menu press F1 for MORE MENU.
- 2 Select EDIT AUTOSCAN LIST from the menu. A list of defined computers will appear. The starred computers will be autoscanned during the autoscan cycle. To add a computer to the autoscan list, move the selection bar over the computer name and press SPACE BAR. To add all named computers press F1. To remove all named computers press F2.
- 3 When all the computers that you wish to scan have a star to the right hand side of their name, press RETURN or ENTER to save the selections. The selected computers will be autoscanned in alphabetical order when you activate autoscan mode (when the SCAN LIST option is selected).

Autoscan Period

Settings: *DISABLED; 2, 5, 7, 10, 15, 20, 30 SECONDS, 1, 5 MINUTES*

The autoscan time defines the length of time that the ServSwitch Duo IPC will display video from an autoscanned computer before changing to the next computer. If the DISABLED setting is chosen then no autoscan functions will be available.

OSD Dwell Time

Settings: *1, 2, 3, 5, 10 SECONDS*

After a successful computer channel change the ServSwitch Duo IPC will display a confirmation message for a few seconds. The length of time that this confirmation message dwells on the screen may be changed.

User Timeout

Settings: *1, 2, 5, 10, 30 SECONDS, 1, 5, 10 MINUTES*

When two users are connected to the same computer only one can have access at any one time. When no keyboard or mouse data has been received from the active user port for the user timeout period, the ServSwitch Duo IPC will allow other users to access the computer. The new port then becomes the active port until it too times out. To avoid confusion between users it is desirable to set the timeout period to be sufficiently long so that user's work is not needlessly interrupted by other users and sufficiently short to ensure good overall system efficiency. The user timeout value also controls the timeout between the local and remote access points on user ports 1 and 3.

RS232 Mouse Type

Settings: *INTELLIMOUSE, 2 BUTTON, 3 BUTTON*

This setting controls the type of RS232 mouse that the ServSwitch Duo IPC reports to computers. All the necessary conversions are dealt with automatically with the ServSwitch Duo IPC. The IntelliMouse setting sends four byte mouse reports to the computers and is therefore very slightly more sluggish than the others that send three byte mouse reports. RS232 mice are almost always more sluggish than PS/2 types because the data rate is much slower.

Mouse Type

Settings: *LOGITECH, MICROSOFT*

This setting determines how the mouse type is reported to each connected PC. Some Logitech mouse drivers are unable to handle the more advanced features of Microsoft Intellimouse Explorer type mice, so the LOGITECH setting here reports a more basic mouse type.



User Preferences

The User Preferences are system operating parameters that are independently selectable for each user and affect only their screen.

To access User Preferences:

- 1 Select the on-screen menu in one of three ways:
 - By simultaneously pressing and then releasing **Ctrl** **Alt** **M**.
 - By pressing the middle and right buttons of a three button mouse, or
 - By selecting port **IP** using the front panel buttons

If you are not already [logged in](#), do so now.

- 2 Press **F1** to select 'More menus'.
- 3 Highlight 'User Preferences' and press **Enter**.
- 4 Use the following keys:
 - Up** and **Down** to highlight required options.
 - Space** to change option values.
 - Esc** to quit and save the changes.

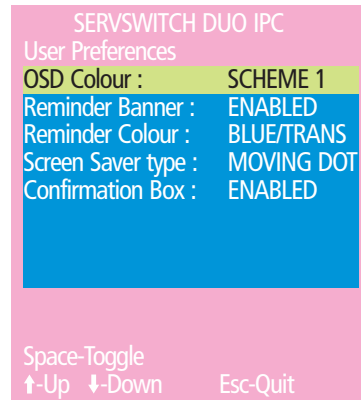

OSD Colour

Settings: *SCHEME 1, SCHEME 2, SCHEME 3*

As you toggle between these options you will see the colour of the menu change to show the selected scheme. The menu schemes have been specially chosen to provide a high contrast with the colours that you would normally see on a computer screen.

Reminder Banner

Settings: *ENABLED, DISABLED*

When the reminder banner is enabled, the name of the currently selected computer will appear in a small reminder banner. This is normally located at the top of the screen in a central position but may be moved as required (see [To move the reminder banner](#)).

Reminder Colour

Settings: *BLUE/TRANS, PINK/TRANS, BLUE/WHITE, WHITE/RED*

You may select the colour of the reminder banner. The BLUE/TRANS and PINK/TRANS select blue or pink text with a transparent background. The BLUE/WHITE and WHITE/RED settings select blue and white text on solid white and red backgrounds.

Screen Saver Type

Settings: *BLANK, MOVING DOT*

You may select the type of screen saver. If you select BLANK then the screen will blank completely. If you select MOVING DOT then a moving dot will be displayed on a blank background. The dot regularly changes colour and bounces off the sides of the screen in a zigzag pattern.

Confirmation Box

Settings: *DISABLED, ENABLED*

When enabled, a confirmation box is displayed on screen for three seconds after a computer is selected. The confirmation box indicates the current user port and user name, the selected computer and the connection status.





Functions

The Functions menu contains a collection of procedures that affect various aspects of ServSwitch Duo IPC operation. Only the Admin user will have access to all functions, other users are offered only the following options:

- *Restore Standard Mouse*,
- *Restore Intellimouse*,
- *Power control* - only computers to which a user has access rights can be switched.

To access Functions

- 1 Select the on-screen menu in one of three ways:
 - By simultaneously pressing and then releasing **Ctrl** **Alt** **M**.
 - By pressing the middle and right buttons of a three button mouse, or
 - By selecting port **1** using the front panel buttons

If you are not already [logged in](#), do so now.

- 2 Press **F1** to select 'More menus'.
- 3 Highlight 'Functions' and press **Enter**.
- 4 Use the following keys:
 - Up** and **Down** to highlight required options.
 - Space** to change option values.
 - Esc** to quit and save the changes.

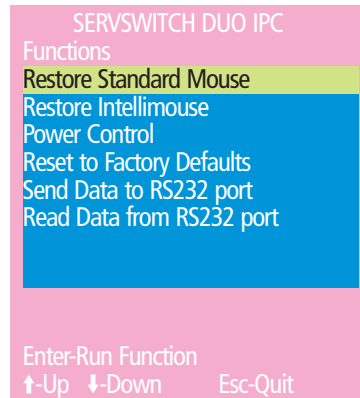

Restore Standard Mouse

This option is used to resume standard mouse operation if it has ceased to operate, for instance, if it has been connected without rebooting the ServSwitch Duo IPC. See [Hot plugging and mouse restoration](#) for more details.

Restore Intellimouse

This option is used to resume Microsoft Intellimouse operation if it has ceased to operate, for instance, if it has been connected without rebooting the ServSwitch Duo IPC. See [Hot plugging and mouse restoration](#) for more details.

Power Control

The options within this section are usable only when the ServSwitch Duo IPC is used in conjunction with one or more external power switch units. For more details see: power switching [connections](#), [configuration](#) or [operation](#).

Switch Computer ON

Select this option to power on one or more computers.

Switch Computer OFF

Select this option to power off one or more computers.

Edit Power ON String

Select this option to alter the special codes that are sent from the ServSwitch Duo IPC to the connected power switch(es) in order to switch computers on.

Edit Power OFF String

Select this option to alter the special codes that are sent from the ServSwitch Duo IPC to the connected power switch(es) in order to switch computers off.

Reset to Factory Defaults

Returns all key settings within the ServSwitch Duo IPC to their original states. *WARNING: This function will clear all computer and user lists that are stored within the ServSwitch Duo IPC.*

When this option is selected, you must press **F8** to confirm the action. The internal data will be rewritten and a completion message displayed after a short period.

Send Data to RS232 port

This option is used to save ServSwitch Duo IPC configuration information to a specially connected computer. A temporary link must be made using the serial port at the rear of the ServSwitch Duo IPC and the computer must run a custom routine available from [Black Box support](#). The resulting download file can be optionally edited (using Microsoft Excel) and/or reloaded into the ServSwitch Duo IPC. This option is especially useful in complex cascade arrangements where many computers are attached. See [Saving and restoring configuration settings](#) for more details.

Read Data from RS232 port

This option is used to reload configuration information into the ServSwitch Duo IPC from a specially connected computer. See above for more details.



Advanced Options

Advanced options are available only to the Admin user and consist of settings that are related to specialist areas such as power control and DDC.

To access Advanced Options:

- Select the on-screen menu in one of three ways:
 - By simultaneously pressing and then releasing **Ctrl**, **Alt**, and **M**.
 - By pressing the middle and right buttons of a three button mouse, or
 - By selecting port **F** using the front panel buttons.

If you are not already logged in, do so now. [What to do if the ADMIN password has been forgotten.](#)

- Press **F1** to select 'More menus', then press **F1** again to select the next level of 'More menus'.
- Use the following keys:
 - ↑** and **↓** to highlight required options.
 - Space** to change option values.
 - Esc** to quit and save the changes.

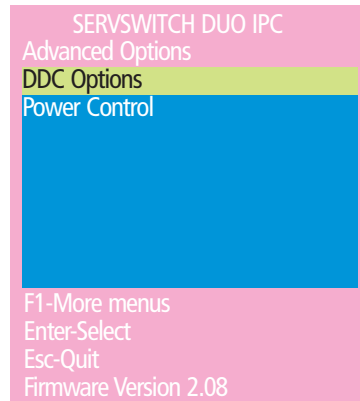

DDC Options

The options within this section are related to the Display Data Channel features supported by the ServSwitch Duo IPC.

DDC Function

Settings: *ENABLED, DISABLED*

When enabled, the ServSwitch Duo IPC can discover the capabilities of a user port video monitor and transmit that information to the connected computers so that they can moderate their video output to suit the monitor.

DDC Source

Settings: *AUTO, USER 1, USER 2*

Determines which user port monitor should be interrogated to discover its capabilities. *AUTO* begins with user port 1 and moves to the other port if no readable monitor is connected. *USER 1* and *USER 2* constrain the ServSwitch Duo IPC to look only at specific ports.

DDC Refresh

Settings: *AT START, DISABLED*

AT START sets the ServSwitch Duo IPC to read DDC information from the selected user port at power up. When *DISABLED*, no new DDC data is sought and existing information is used. When viewing this menu, press **F8** to perform a discover DDC information from the chosen user port immediately.

Power Control

The options within this section are concerned with the operation of the RS232 COM port when used to command optional system power control units.

Power Control

Settings: *ENABLED, DISABLED*

When enabled, the RS232 COM port can be used only to send commands to optional power control modules connected to it. When disabled, it may be used for multiple video head synchronisation, configuration data transfer or flash upgrades, as required.

Baud Rate

Settings: *1200, 2400, 4800, 9600, 19200*

Configures the communication speed of the serial port and must match the speed used by the connected power switch(es).

Format

Settings: *NONE.8.1, ODD.8.1, EVEN.8.1, NONE.8.2, NONE.7.2, ODD.7.2, EVEN.7.2,*

Configures the data format used by the serial port and must match the format used by the connected power switch(es). The NONE/ODD/EVEN portion relates to the parity checking; the 7/8 value is the size of the data byte and the 1/2 value determines the stop bit(s) used after each data byte.

Appendix 2 – Firmware upgrade

The ServSwitch Duo IPC uses flash memory technology that allows you to upgrade the firmware code. Upgrades are performed by connecting the serial port of a nearby computer to the port marked COM on the rear panel of the ServSwitch Duo IPC. You can then obtain an upgrade program from [Black Box support](#) and run it on the computer. This will download the new firmware to the ServSwitch Duo IPC and check that the data has been programmed correctly.



Note: The normal flash upgrade process does not clear the computer names, user names, security passwords or other configuration settings.



Items needed to perform the upgrade

- Optional serial upgrade cable available from Black Box (see [Appendix 3](#) for pin-out specifications).
- A Windows computer with an RS232 serial port.
- The latest version of the ServSwitch Duo IPC firmware - available from [Black Box support](#).

To check your current firmware version

1 Select the on-screen menu in one of three ways:

- By simultaneously pressing and then releasing   .

Note: The  and  hotkeys may have been changed. If the combination fails to work, then please contact the system administrator for details.

- By pressing the middle and right buttons of a three button mouse, or
- By selecting port  using the front panel buttons

If you are not already [logged in](#), do so now.

2 Press  to select 'More menus'.

The version number of the current firmware will then be displayed at the bottom of the Configuration Menu.

To perform a flash upgrade on the ServSwitch Duo IPC

1 - Prepare your computers.

Ensure that you have saved any important work on the connected computers. The ServSwitch Duo IPC can be upgraded whilst attached to live computers but remember that the mouse connections will probably need to be reconstituted after the upgrade is finished. Where possible, mission critical servers should be switched off or disconnected before performing an upgrade.

2 - Connect your computer to the ServSwitch Duo IPC

Connect the serial port of the computer to the port marked COM on the rear panel of the ServSwitch Duo IPC. You do not need to set the serial baud rate and protocol because the upgrade program will do this automatically (for reference, the RS232 baud rate used by the upgrade program is 19200 and the protocol is 8 bits, 1 stopbit and no parity).

3 - Select flash upgrade mode using option switch 2 (labelled UPGRADE)

Move option switch 2 on the back of the ServSwitch Duo IPC to the ON position (down).

4 - Power off the ServSwitch Duo IPC

Remove the power supply plug from the rear panel of the ServSwitch Duo IPC.

5 - Power on the ServSwitch Duo IPC with the UPGRADE switch ON

Attach the power adapter to the ServSwitch Duo IPC whilst the UPGRADE switch is ON. The green USER display should now show . This indicates that the ServSwitch Duo IPC is ready to be upgraded.

6 - Obtain and run the upgrade program

- a The latest version of the ServSwitch Duo IPC firmware is available from [Black Box support](#). The upgrade files are supplied as a compressed ZIP file. Decompress the ZIP file with an appropriate tool such as WinZip (www.winzip.com) and copy all contained files to the same folder on your computer.

From that folder, select the **KVMUploader** icon to run the upgrade application.

continued



The KVM Firmware Uploader dialog will be displayed:

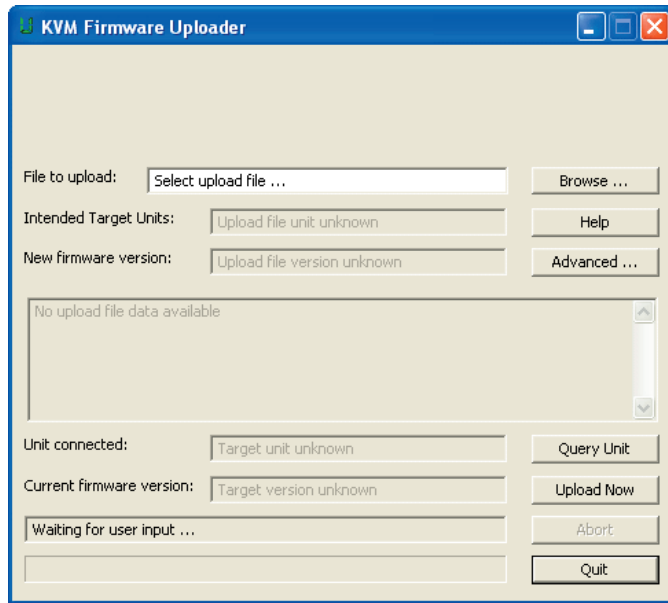

- b Click the *Browse...* button and select the upgrade file that is appropriate to your ServSwitch Duo IPC unit:

ServSwitch Duo IPC 8 port model: Duoipc_2x8_Vx.xx
ServSwitch Duo IPC 16 port model: Duoipc_2x16_Vx.xx
where Vx.xx is the upgrade file version number.

The upgrade file details will be displayed within the dialog.

- c Click the *Query Unit* button to confirm that communication is possible with the ServSwitch Duo IPC and to establish its current firmware details. If the application cannot contact the ServSwitch Duo IPC, recheck the connection cable and click the *Advanced...* button to check that the correct serial port is being used. Change the serial port within the *Advanced* section, if necessary.
- d To begin the upgrade process, click the *Upload Now* button. The upload normally takes roughly fifteen minutes and the progress will be shown within the dialog. Should you decide not to continue with the upload at any stage, click the *Abort* button; response to this is usually immediate, however, during an erase command, the upload will not be aborted until the erase is complete (this may take a few seconds).

7 - Switch the UPGRADE key to the OFF position and cycle the power

Switch the switch 2 on the rear of the ServSwitch Duo IPC to the OFF position and disconnect the power. When the power is re-applied the ServSwitch Duo IPC will operate using the new firmware.

Issues to consider when performing flash upgrades

The upgrade program rewrites the ServSwitch Duo IPC firmware code. If the upgrade process is interrupted then the ServSwitch Duo IPC will have invalid code and will not be able to operate. It is therefore good practice to ensure that the upgrade process is always fully completed. A partial or failed upgrade may be rectified by performing another upgrade. If the upgrade process is interrupted accidentally then you should immediately repeat the upgrade process without moving switch 2 from the upgrade (ON) position. Switch 2 forces the ServSwitch Duo IPC into flash upgrade mode and prevents the upgraded code from being run. Running faulty or partially upgraded code may have unpredictable results and may damage your ServSwitch Duo IPC or computing equipment.

WARNING: Running faulty or partially upgraded code may have unpredictable results and may damage your ServSwitch Duo IPC or computing equipment.





ServSwitch Duo IPC setup cable

9pin D-type female

9pin D-type female

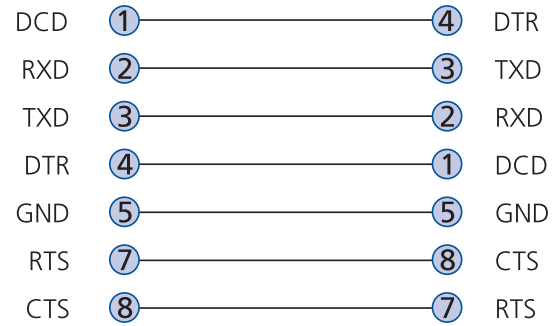

ServSwitch Duo IPC to power switch cable

9pin D-type female

4pin RJ9

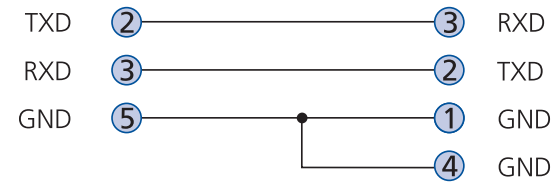

Power switch to power switch daisy chain cable

4pin RJ9

4pin RJ9

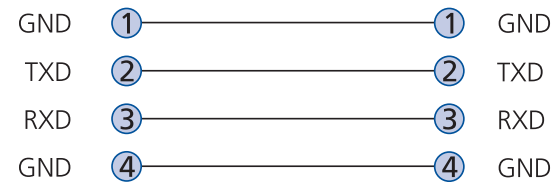

INSTALLATION

CONFIGURATION

OPERATION

FURTHER INFORMATION

INDEX

Safety information

- For use in dry, oil free indoor environments only.
- Warning - live parts contained within power adapter.
- No user serviceable parts within power adapter - do not dismantle.
- Plug the power adapter into a socket outlet close to the module that it is powering.
- Replace the power adapter with a manufacturer approved type only.
- Do not use the power adapter if the power adapter case becomes damaged, cracked or broken or if you suspect that it is not operating properly.
- If you use a power extension cord with the ServSwitch Duo IPC, make sure the total ampere rating of the devices plugged into the extension cord does not exceed the cord's ampere rating. Also, make sure that the total ampere rating of all the devices plugged into the wall outlet does not exceed the wall outlet's ampere rating.
- Do not attempt to service the ServSwitch Duo IPC yourself.

Safety considerations when using power switches with ServSwitch Duo IPC

- Follow the manufacturer's instructions when setting up and using power switching products.
- Always ensure that the total ampere rating of the devices plugged into the power switching product does not exceed the power switching product's ampere rating. Also, make sure that the total ampere rating of all the devices plugged into the wall outlet does not exceed the wall outlet's ampere rating.



INSTALLATION

CONFIGURATION

OPERATION

FURTHER
INFORMATION

INDEX

Radio Frequency Energy

A Category 5 (or better) twisted pair cable must be used to connect the units in order to maintain compliance with radio frequency energy emission regulations and ensure a suitably high level of immunity to electromagnetic disturbances.

All other interface cables used with this equipment must be shielded in order to maintain compliance with radio frequency energy emission regulations and ensure a suitably high level of immunity to electromagnetic disturbances.

European EMC directive 89/336/EEC

This equipment has been tested and found to comply with the limits for a class A computing device in accordance with the specifications in the European standard EN55022. These limits are designed to provide reasonable protection against harmful interference. This equipment generates, uses and can radiate radio frequency energy and if not installed and used in accordance with the instructions may cause harmful interference to radio or television reception. However, there is no guarantee that harmful interference will not occur in a particular installation. If this equipment does cause interference to radio or television reception, which can be determined by turning the equipment on and off, the user is encouraged to correct the interference with one or more of the following measures: (a) Reorient or relocate the receiving antenna. (b) Increase the separation between the equipment and the receiver. (c) Connect the equipment to an outlet on a circuit different from that to which the receiver is connected. (d) Consult the supplier or an experienced radio/TV technician for help.

FCC Compliance Statement (United States)

This equipment generates, uses and can radiate radio frequency energy and if not installed and used properly, that is, in strict accordance with the manufacturer's instructions, may cause interference to radio communication. It has been tested and found to comply with the limits for a class A computing device in accordance with the specifications in Subpart J of part 15 of FCC rules, which are designed to provide reasonable protection against such interference when the equipment is operated in a commercial environment. Operation of this equipment in a residential area may cause interference, in which case the user at his own expense will be required to take whatever measures may be necessary to correct the interference. Changes or modifications not expressly approved by the manufacturer could void the user's authority to operate the equipment.

Canadian Department of Communications RFI statement

This equipment does not exceed the class A limits for radio noise emissions from digital apparatus set out in the radio interference regulations of the Canadian Department of Communications.

Le présent appareil numérique n'émet pas de bruits radioélectriques dépassant les limites applicables aux appareils numériques de la classe A prescrites dans le règlement sur le brouillage radioélectriques publié par le ministère des Communications du Canada.



INSTALLATION

CONFIGURATION

OPERATION

FURTHER INFORMATION

INDEX

Normas Oficiales Mexicanas (NOM) electrical safety statement



Instrucciones de seguridad

- 1 Todas las instrucciones de seguridad y operación deberán ser leídas antes de que el aparato eléctrico sea operado.
- 2 Las instrucciones de seguridad y operación deberán ser guardadas para referencia futura.
- 3 Todas las advertencias en el aparato eléctrico y en sus instrucciones de operación deben ser respetadas.
- 4 Todas las instrucciones de operación y uso deben ser seguidas.
- 5 El aparato eléctrico no deberá ser usado cerca del agua—por ejemplo, cerca de la tina de baño, lavabo, sótano mojado o cerca de una alberca, etc.
- 6 El aparato eléctrico debe ser usado únicamente con carritos o pedestales que sean recomendados por el fabricante.
- 7 El aparato eléctrico debe ser montado a la pared o al techo sólo como sea recomendado por el fabricante.
- 8 Servicio—El usuario no debe intentar dar servicio al equipo eléctrico más allá a lo descrito en las instrucciones de operación. Todo otro servicio deberá ser referido a personal de servicio calificado.
- 9 El aparato eléctrico debe ser situado de tal manera que su posición no interfiera su uso. La colocación del aparato eléctrico sobre una cama, sofá, alfombra o superficie similar puede bloquea la ventilación, no se debe colocar en libreros o gabinetes que impidan el flujo de aire por los orificios de ventilación.
- 10 El equipo eléctrico deber ser situado fuera del alcance de fuentes de calor como radiadores, registros de calor, estufas u otros aparatos (incluyendo amplificadores) que producen calor.
- 11 El aparato eléctrico deberá ser conectado a una fuente de poder sólo del tipo descrito en el instructivo de operación, o como se indique en el aparato.
- 12 Precaución debe ser tomada de tal manera que la tierra física y la polarización del equipo no sea eliminada.
- 13 Los cables de la fuente de poder deben ser guiados de tal manera que no sean pisados ni pellizcados por objetos colocados sobre o contra ellos, poniendo particular atención a los contactos y receptáculos donde salen del aparato.
- 14 El equipo eléctrico debe ser limpiado únicamente de acuerdo a las recomendaciones del fabricante.
- 15 En caso de existir, una antena externa deberá ser localizada lejos de las líneas de energía.
- 16 El cable de corriente deberá ser desconectado del cuando el equipo no sea usado por un largo periodo de tiempo.
- 17 Cuidado debe ser tomado de tal manera que objetos liquidos no sean derramados sobre la cubierta u orificios de ventilación.
- 18 Servicio por personal calificado deberá ser provisto cuando:
 - A: El cable de poder o el contacto ha sido dañado; u
 - B: Objetos han caído o líquido ha sido derramado dentro del aparato; o
 - C: El aparato ha sido expuesto a la lluvia; o
 - D: El aparato parece no operar normalmente o muestra un cambio en su desempeño; o
 - E: El aparato ha sido tirado o su cubierta ha sido dañada.

INSTALLATION

CONFIGURATION

OPERATION

FURTHER INFORMATION

INDEX



© 2006 Black Box Corporation
All trademarks are acknowledged.

Black Box Corporation,
1000 Park Drive,
Lawrence,
PA 15055-1018,
United States of America
Tel: +1-724-746-5500
Fax: +1-724-746-0746

INSTALLATION

CONFIGURATION

OPERATION

FURTHER
INFORMATION

INDEX

Index



A

Access activity
 logging 28
Addressing
 cascaded computers 14
 power switch boxes 11
ADMIN
 forgotten password 23
 password 19
Advanced options 42
Apple computer 8
ASCII
 codes for switching 27
Autoscanning 21

B

Baud rate 42
Brackets 4

C

Cable specifications 45
Cascade
 groups 13
Cascaded computers
 selecting 34
Cascade connections 12
 addressing 14
 how they work 13
 testing 15
 tips for success 15
Computer
 name editing 20
 port connections 6
 selecting 31

Configuration
 power switching 26
 saving and restoring 22
Configuration menus 37
Confirmation box 34
Connections 5
 computer port 6
 local user port 6
 power supply 9
 power switching 11
 to Sun computer 7
 to USB port computer 8
 user port 9

D

DDC 28
 options 42
Display Data Channel
 configuring 28
 user port connections 6

E

Extended user port
 connections 9

F

Format
 power control port 42
Front panel
 controls 30
Front panel controls 30
Functions 41

G

Global preferences 38

H

HEX
 codes for switching 27
Hotkey
 clashes 15
Hotkeys
 selecting computers 32
Hot plugging 24

I

Initial configuration 17
IntelliMouse 24

K

Keyboard
 reset 25

L

Local user port
 connections 6
Logging access activity 28
Logging in and out
 section 33

M

Mounting 5
Mounting brackets 5
Mouse
 resetting 25
 restoration 24
Mouse acceleration
 disabling 25
Multiple video head
 connections 16

P

Password
 admin 19
 forgotten 23
Port Direct 29
Powering on 30
Power control
 options 42
Power strings
 for switching 26
Power supply
 connection 9
Power switching
 addressing 11
 configuration 26
 connections 11
 creating port groups 27
 strings 27
 using 35
R
Reminder banner 34
Reset
 keyboards and mice 25
 restoring factory defaults 23
Routing status 34

S

Security
 enabling 19
Selecting
 cascaded computers 34
 computers 31
 with front panel 31
 with hotkeys 32
 with mouse buttons 32
 with on-screen menu 31
Serial port
 power switching 23,26
Setup options 37
Sun computer 7,8

T

Testing
 links to cascaded computers
 15
Troubleshooting 36

U

Upgrading
 firmware 43
User preferences 40

INSTALLATION

CONFIGURATION

OPERATION

FURTHER
INFORMATION

INDEX

BlackBox subsidiary contact details



| Country | Web Site/Email | Phone | Fax |
|---------------|--|-------------------|-------------------|
| United States | www.blackbox.com | 724-746-5500 | 724-746-0746 |
| Austria | www.black-box.at support@black-box.at | +43 1 256 98 56 | +43 1 256 98 56 |
| Belgium | www.blackbox.be support.nederlands@blackbox.be support.french@blackbox.be support.english@blackbox.be | +32 2 725 85 50 | +32 2 725 92 12 |
| Denmark | www.blackbox.dk blackbox@blackbox.dk | +32 2 725 85 50 | +32 2 725 92 12 |
| Finland | www.blackbox.fi tuki@blackbox.fi | +35 201 888 800 | +35 201 888 808 |
| France | www.blackbox.fr tech@blackbox.fr | +33 1 45 606 717 | +33 1 45 606 747 |
| Germany | www.black-box.de techsupp@black-box.de | +49 811 5541 110 | +49 811 5541 499 |
| Italy | www.blackbox.it supporto.tecnico@blackbox.it | +39 02 27 404 700 | +39 02 27 400 219 |
| Netherlands | www.blackbox.nl techsupport@blackbox.nl | +31 30 241 7799 | +31 30 241 4746 |
| Norway | www.blackboxnorge.no support@blackboxnorge.no | +47 55 300 710 | +47 55 300 701 |
| Spain | www.blackbox.es tecnico@blackbox.es | +34 9162590732 | +34 916239784 |
| Sweden | www.blackboxab.se support@blackboxab.se | +46 8 44 55 890 | +46 08 38 04 30 |
| Switzerland | www.black-box.ch support@black-box.ch | +41 55 451 70 71 | +41 55 451 70 75 |
| UK | www.blackbox.co.uk techhelp@blackbox.co.uk | +44 118 965 6000 | +44 118 965 6001 |
| Ireland | www.blackbox.co.uk techhelp@blackbox.co.uk | +353 1 662 2466 | +353 1 662 2477 |

INSTALLATION

CONFIGURATION

OPERATION

FURTHER
INFORMATION

INDEX