

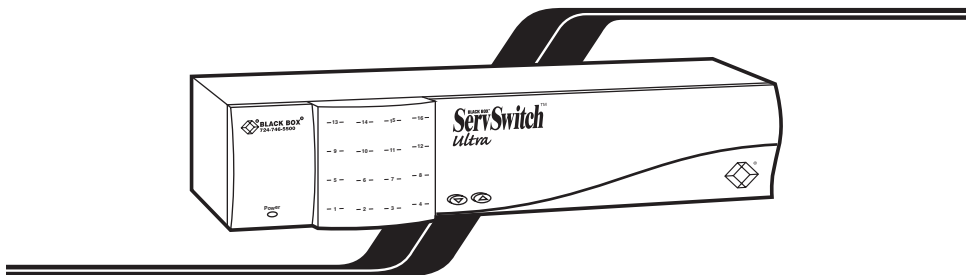

Step-By-Step Quick Install Guide for the ServSwitch™ Ultra



1. Introduction

This guide is designed to quickly show you how to attach cables and equipment in order to install a ServSwitch Ultra system. For just the basics, look over the diagram on the next two pages. More detailed instructions begin on page 4.

SERVSWITCH™ ULTRA QUICK INSTALL GUIDE

1 Attach User Adapter Cable.

2 Attach monitor (VGA type shown).

3 Plug in monitor.

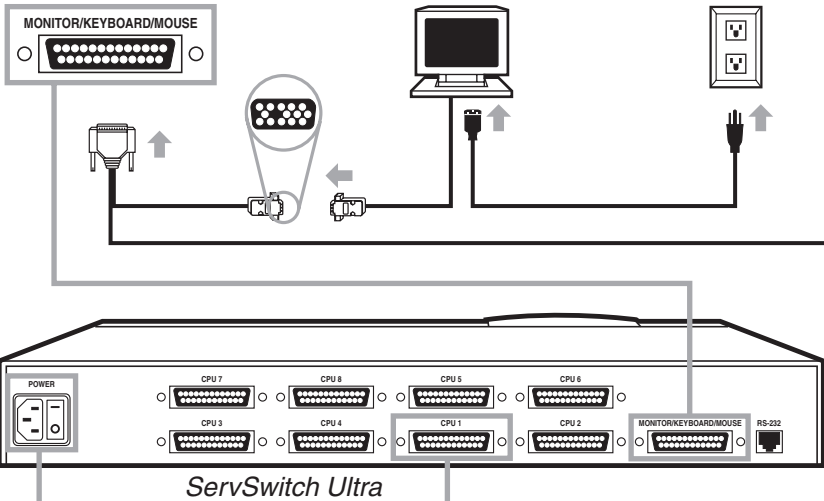

5a If a CPU has **separate keyboard and mouse ports**, use CPU Adapter Cable to attach it **this way** (PS/2 CPU shown):

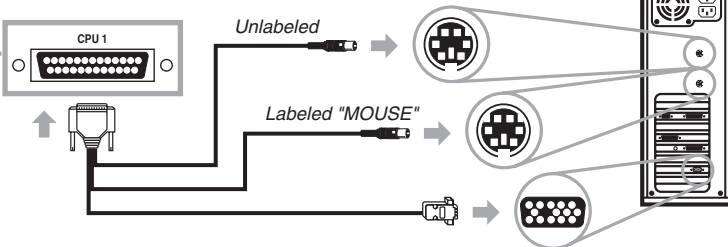

4a If your keyboard and mouse are **IBM compatible**, attach them **this way** (PS/2 equipment shown):

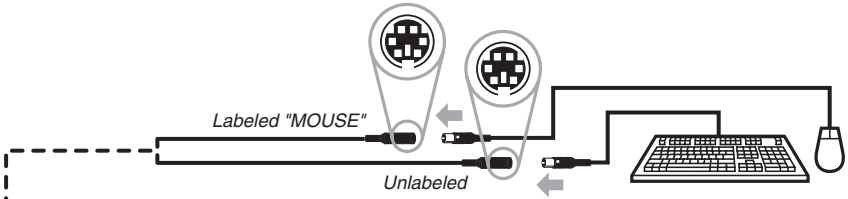

4b If your keyboard and mouse are **Mac or Sun compatible**, attach them **this way** (Sun equipment shown):



6 Plug in CPU.

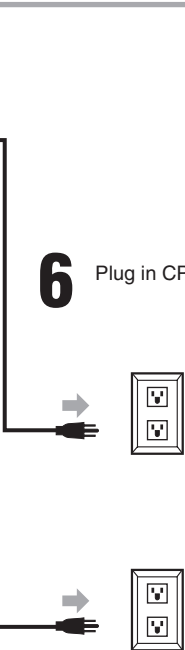

7 Plug in ServSwitch.

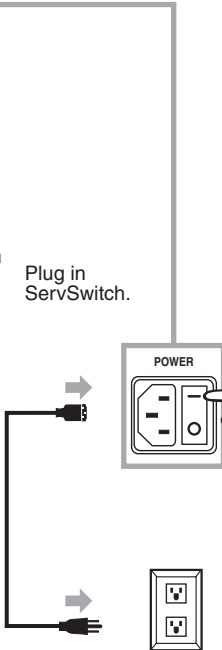

8 Turn on ServSwitch.

9 Turn on monitor and all CPUs.

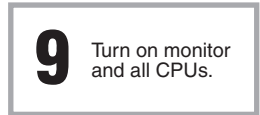

SERVSWITCH™ ULTRA QUICK INSTALL GUIDE

The rest of this guide is divided into five sections, one for each connection type:

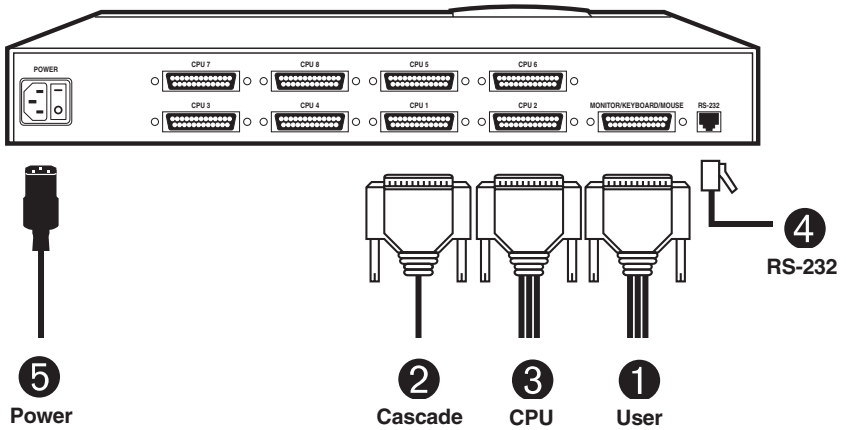

Figure 1. Connection sequence.

- 1 **Required:** Section 2, **User-Station** Connections (see **page 5**).
- 2 **Optional:** Section 3, **Cascade** Connections (see **page 14**).
- 3 **Required:** Section 4, **CPU** Connections (see **page 15**).
- 4 **Optional:** Section 5, The **RS-232** Connection (see **page 26**).
- 5 **Required:** Section 6, The **Power** Connection (see **page 28**).

2. User-Station Connections

Which cables you use for these and how you connect them to the ServSwitch Ultra and to your user-station equipment will depend on what type of equipment you're using:

If your keyboard and mouse are this type (with this connector):	And if your monitor is this type (with this connector):	Refer to this section (on this page):
IBM® PS/2®, RS/6000®, or SGI® (6-pin mini-DIN)	VGA/multisync (HD15)	Section 2.1 (page 6)
IBM PC/AT® keyboard, (5-pin DIN), RS-232 serial mouse (DB9)	VGA/multisync (HD15)	Section 2.2 (page 7)
IBM PS/2 or RS/6000 (6-pin mini-DIN)	RS/6000 (13W3)	Section 2.3 (page 8)
IBM PS/2 or SGI (6-pin mini-DIN)	SGI (13W3)	Section 2.4 (page 9)
Sun Microsystems® (8-pin mini-DIN)	Sun® (13W3)	Section 2.5 (page 10)
Sun Microsystems (8-pin mini-DIN)	VGA/multisync (HD15)	Section 2.6 (page 11)
Apple® Macintosh® (4-pin mini-DIN)	Mac® (DB15)	Section 2.7 (page 12)
Apple Macintosh (4-pin mini-DIN)	VGA/multisync (HD15)	Section 2.8 (page 13)





SERVSWITCH™ ULTRA QUICK INSTALL GUIDE

2.1 IBM PS/2 COMPATIBLE KEYBOARD AND MOUSE, VGA/MULTISYNC MONITOR

If your keyboard and mouse are IBM PS/2 compatible (which includes current RS/6000 and SGI keyboards and mice, as well as the Microsoft® IntelliMouse®), and your monitor is a VGA, SVGA, XGA, or multisync type with an HD15 video connector, first choose your Monitor/Keyboard/Mouse Adapter Cable (User Cable):

- If your video resolution is *not* higher than 1024 x 768 pixels, and if your equipment is within 20 ft. (6.1 m) of the Switch, you can use the **standard** (non-coaxial) cable with the product code **EHN054**.
- If your video resolution is higher than 1024 x 768, or if your equipment is farther than 20 ft. (6.1 m) from the Switch, you should use the **coaxial** cable with the product code **EHN283**.

When you have the correct cable, hook it up to the ServSwitch Ultra and your equipment this way, as shown in Figure 2:

- Plug the cable's **DB25**  connector into the Switch's MONITOR/KEYBOARD/MOUSE port.
- Plug the mouse into the cable's **6-pin mini-DIN**  connector with the "MOUSE" label on it.
- Plug the keyboard into the cable's **unlabeled 6-pin mini-DIN**  connector.
- Plug the monitor into the cable's **HD15**  connector.

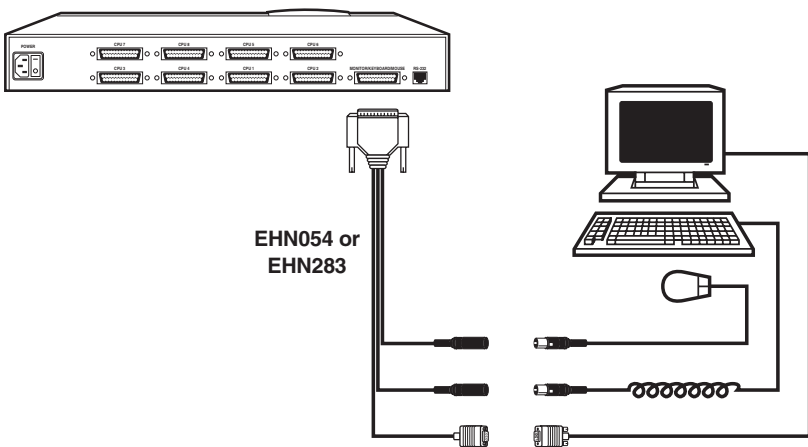





Figure 2. PS/2 type user-station connections.

2.2 IBM PC/AT COMPATIBLE KEYBOARD, RS-232 SERIAL MOUSE, VGA/MULTISYNC MONITOR

If your keyboard is PC/AT compatible, your mouse is an RS-232 serial type, and your monitor is a VGA, SVGA, XGA, or multisync type with an HD15 video connector, first choose your Monitor/Keyboard/Mouse Adapter Cable (User Cable):

- If your video resolution is *not* higher than 1024 x 768 pixels, and if your equipment is within 20 ft. (6.1 m) of the Switch, you can use the **standard** (non-coaxial) cable with the product code **EHN052**.
- If your video resolution is higher than 1024 x 768, or if your equipment is farther than 20 ft. (6.1 m) from the Switch, you should use the **coaxial** cable with the product code **EHN270**.

When you have the correct cable, hook it up to the ServSwitch Ultra and your equipment this way, as shown in Figure 3:

- Plug the cable's **DB25**  connector into the Switch's MONITOR/KEYBOARD/MOUSE port.
- Plug the mouse into the cable's **DB9**  connector.
- Plug the keyboard into the cable's **5-pin DIN**  connector.
- Plug the monitor into the cable's **HD15**  connector.

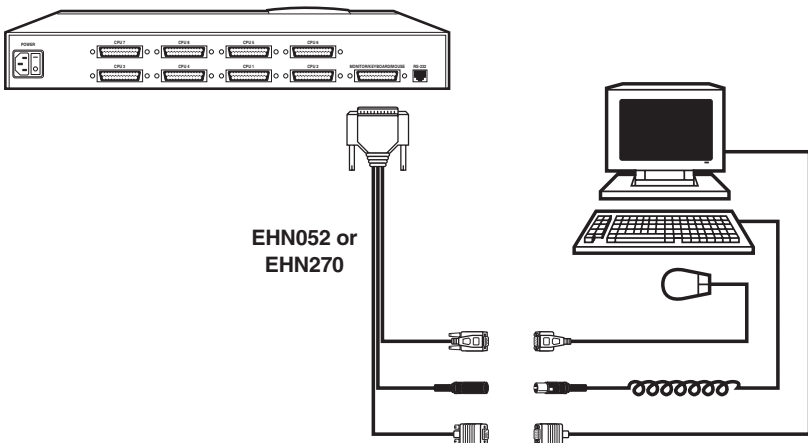





Figure 3. PC/AT type user-station connections.

2.3 IBM PS/2 COMPATIBLE KEYBOARD AND MOUSE, RS/6000 MONITOR

If your keyboard and mouse are IBM PS/2 compatible (which includes current RS/6000 keyboards and mice, as well as the Microsoft IntelliMouse), and your monitor is an RS/6000 type with a 13W3 video connector, use the coaxial Monitor/Keyboard/Mouse Adapter Cable (User Cable) with the product code **EHN521-0001**. (Note that this cable is available as a stock item only in a 1-ft. [0.3-m] length; call for a quote if you need a longer version.) Hook this cable up to the ServSwitch Ultra and your equipment this way, as shown in Figure 4:

- Plug the cable's **DB25**  connector into the Switch's **MONITOR/KEYBOARD/MOUSE** port.
- Plug the mouse into the cable's **6-pin mini-DIN**  connector with the **"MOUSE"** label on it.
- Plug the keyboard into the cable's **unlabeled 6-pin mini-DIN**  connector.
- Plug the monitor into the cable's **13W3**  connector.

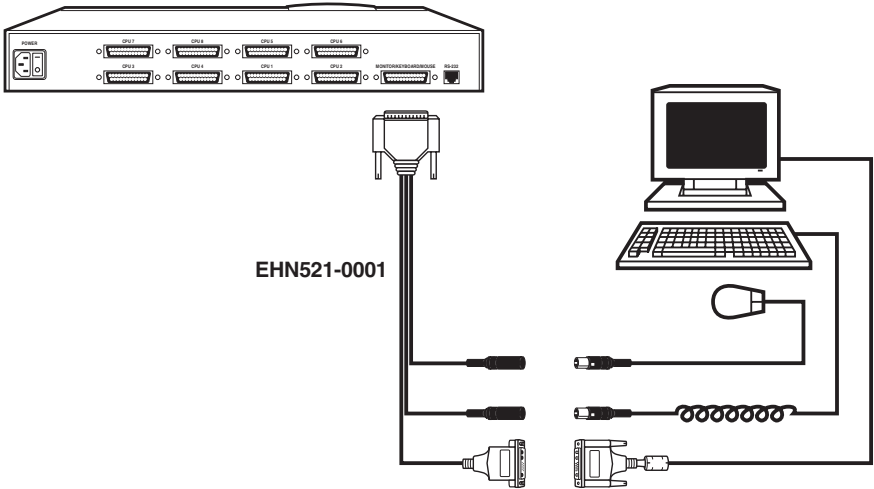





Figure 4. RS/6000 type user-station connections.

2.4 IBM PS/2 COMPATIBLE KEYBOARD AND MOUSE, SGI MONITOR

If your keyboard and mouse are IBM PS/2 compatible (which includes current SGI keyboards and mice, as well as the Microsoft IntelliMouse), and your monitor is an SGI type with a 13W3 video connector, use the coaxial Monitor/Keyboard/Mouse Adapter Cable (User Cable) with the product code **EHN501-0001**. (Note that this cable is available as a stock item only in a 1-ft. [0.3-m] length; call for a quote if you need a longer version.) Hook this cable up to the ServSwitch Ultra and your equipment this way, as shown in Figure 5:

- Plug the cable's **DB25**  connector into the Switch's MONITOR/KEYBOARD/MOUSE port.
- Plug the mouse into the cable's **6-pin mini-DIN**  connector with the "MOUSE" label on it.
- Plug the keyboard into the cable's **unlabeled 6-pin mini-DIN**  connector.
- Plug the monitor into the cable's **13W3**  connector.

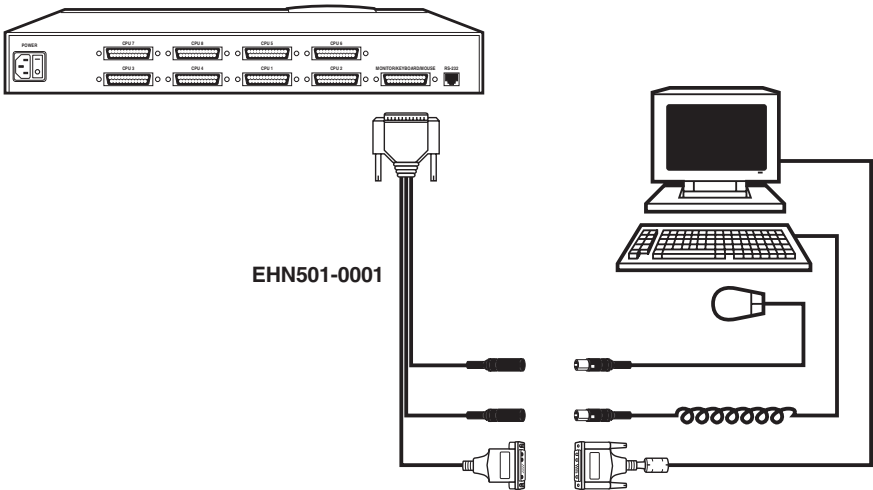





Figure 5. SGI type user-station connections.

2.5 SUN COMPATIBLE KEYBOARD AND MOUSE, SUN MONITOR

If your keyboard and mouse are Sun Microsystems compatible, and your monitor is a Sun type with a 13W3 video connector, use the coaxial Monitor/Keyboard/Mouse Adapter Cable (User Cable) with the product code **EHN201**. Hook this cable up to the ServSwitch Ultra and your equipment this way, as shown in Figure 6:

- Plug the cable's **DB25**  connector into the Switch's MONITOR/KEYBOARD/MOUSE port.
- Plug the mouse into the keyboard.
- Plug the keyboard into the cable's **8-pin mini-DIN**  connector.
- Plug the monitor into the cable's **13W3**  connector.

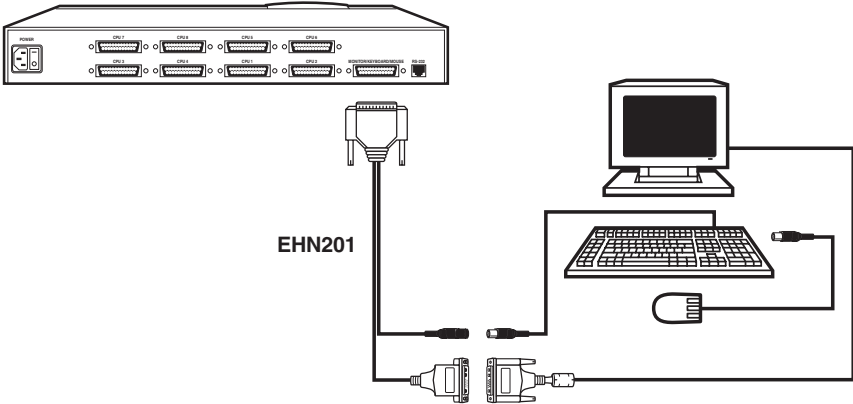





Figure 6. Sun type user-station connections (Sun monitor).

2.6 SUN COMPATIBLE KEYBOARD AND MOUSE, VGA/MULTISYNC MONITOR

If your keyboard and mouse are Sun Microsystems compatible, and your monitor is a multisync type with an HD15 video connector, first choose your Monitor/Keyboard/Mouse Adapter Cable (User Cable):

- If your video resolution is *not* higher than 1024 x 768 pixels, and if your equipment is within 20 ft. (6.1 m) of the Switch, you can use the **standard** (non-coaxial) cable with the product code **EHN059**.
- If your video resolution is higher than 1024 x 768, or if your equipment is farther than 20 ft. (6.1 m) from the Switch, you should use the **coaxial** cable with the product code **EHN225**.

When you have the correct cable, hook it up to the ServSwitch Ultra and your equipment this way, as shown in Figure 7:

- Plug the cable's **DB25**  connector into the Switch's MONITOR/KEYBOARD/MOUSE port.
- Plug the mouse into the keyboard.
- Plug the keyboard into the cable's **8-pin mini-DIN**  connector.
- Plug the monitor into the cable's **HD15**  connector.

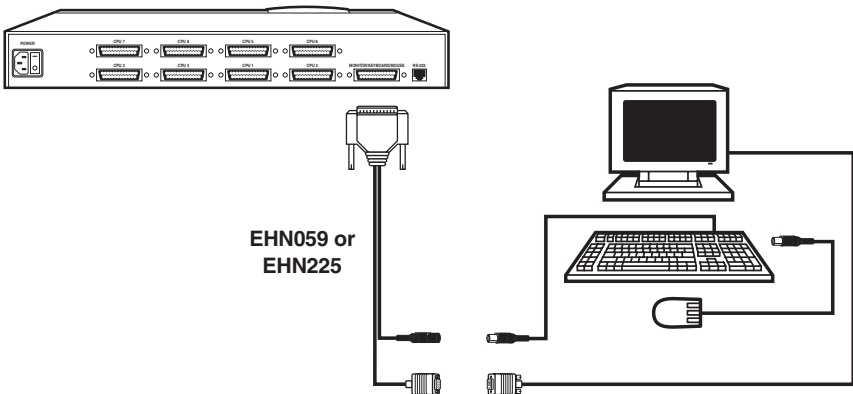





Figure 7. Sun type user-station connections (multisync monitor).

2.7 MAC COMPATIBLE KEYBOARD AND MOUSE, MAC MONITOR

If your keyboard and mouse are Apple Macintosh compatible, and your monitor is a Mac type with a DB15 video connector, first choose your Monitor/Keyboard/Mouse Adapter Cable (User Cable):

- If your video resolution is *not* higher than 1024 x 768 pixels, and if your equipment is within 20 ft. (6.1 m) of the Switch, you can use the **standard** (non-coaxial) cable with the product code **EHN210**.
- If your video resolution is higher than 1024 x 768, or if your equipment is farther than 20 ft. (6.1 m) from the Switch, you should use the **coaxial** cable with the product code **EHN203**.

When you have the correct cable, hook it up to the ServSwitch Ultra and your equipment this way, as shown in Figure 8:

- Plug the cable's **DB25**  connector into the Switch's **MONITOR/KEYBOARD/MOUSE** port.
- Plug the mouse into the keyboard.
- Plug the keyboard into the cable's **4-pin mini-DIN**  connector.
- Plug the monitor into the cable's **DB15**  connector.

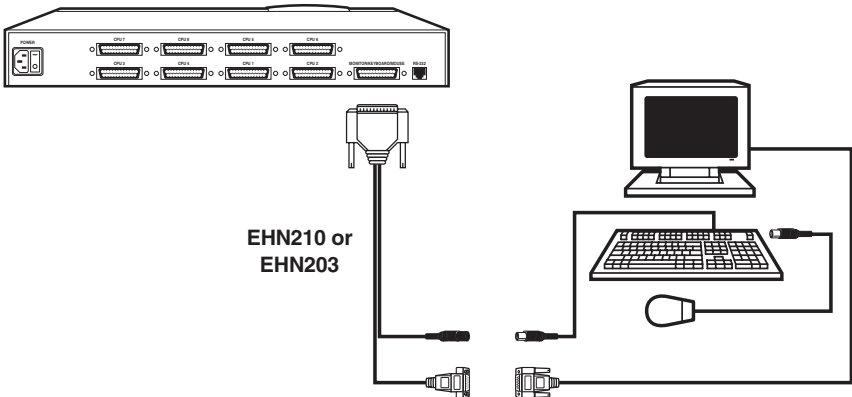





Figure 8. Mac type user-station connections (Mac monitor).

2.8 MAC COMPATIBLE KEYBOARD AND MOUSE, VGA/MULTISYNC MONITOR

If your keyboard and mouse are Apple Macintosh compatible, and your monitor is a multisync type with an HD15 video connector, first choose your Monitor/Keyboard/Mouse Adapter Cable (User Cable):

- If your video resolution is *not* higher than 1024 x 768 pixels, and if your equipment is within 20 ft. (6.1 m) of the Switch, you can use the **standard** (non-coaxial) cable with the product code **EHN532**.
- If your video resolution is higher than 1024 x 768, or if your equipment is farther than 20 ft. (6.1 m) from the Switch, you should use the **coaxial** cable with the product code **EHN540**.

When you have the correct cable, hook it up to the ServSwitch Ultra and your equipment this way, as shown in Figure 9:

- Plug the cable's **DB25**  connector into the Switch's MONITOR/KEYBOARD/MOUSE port.
- Plug the mouse into the keyboard.
- Plug the keyboard into the cable's **4-pin mini-DIN**  connector.
- Plug the monitor into the cable's **HD15**  connector.

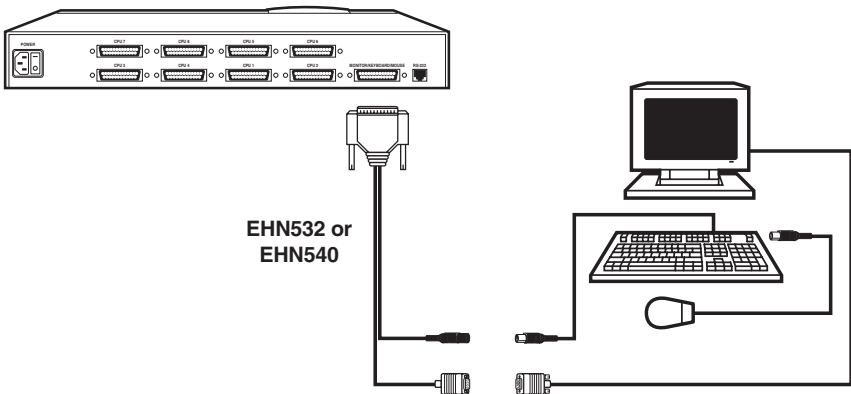

Figure 9. Mac type user-station connections (multisync monitor).

3. Cascade Connections (Optional)

If you want to connect submaster (slave) ServSwitch Ultra units to your master unit, use the coaxial Expansion Cable **EHN284**. Plug one end of this cable (it doesn't matter which end) into the submaster unit's MONITOR/KEYBOARD/ MOUSE port. If this is the first submaster, plug the other end of the cable into the master Switch's CPU 1 port. If this is the second submaster, plug the other end into the master Switch's CPU 2 port, and so on. See Figure 10. (For more information about cascading, refer to **Section 3.3** of your ServSwitch Ultra manual.)

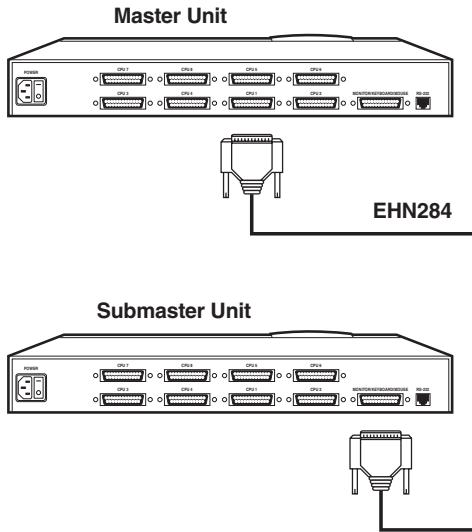

Figure 10. A cascade connection.

4. CPU Connections

Which cables you use and how you connect them will depend on what type of equipment you're using:





If your CPU's keyboard and mouse ports are this type (with this connector):	And if your CPU's video port is this type (with this connector):	Refer to this section (on this page):
IBM PS/2 type (6-pin mini-DIN)	VGA etc. (HD15)	Section 4.1 (page 16)
IBM PC/AT keyboard (5-pin DIN), RS-232 serial mouse (DB9)	VGA etc. (HD15)	Section 4.2 (page 18)
IBM RS/6000 (PS/2 type, 6-pin mini-DIN)	RS/6000 (13W3)	Section 4.3 (page 20)
SGI (PS/2 type, 6-pin mini-DIN)	SGI (13W3)	Section 4.4 (page 21)
Sun Microsystems (8-pin mini-DIN)	Sun (13W3)	Section 4.5 (page 22)
Sun Microsystems (8-pin mini-DIN)	VGA etc. (HD15)	Section 4.6 (page 23)
Apple Macintosh (4-pin mini-DIN)	Mac (DB15)	Section 4.7 (page 24)
Apple Macintosh (4-pin mini-DIN)	Mac G3 (HD15)	Section 4.8 (page 25)

4.1 IBM PS/2 COMPATIBLE KEYBOARD AND MOUSE PORTS, VGA TYPE VIDEO PORTS

If a CPU's keyboard and mouse ports are IBM PS/2 compatible (which includes current RS/6000 and SGI CPUs), and its video port is a VGA, SVGA, XGA, or a compatible type with an HD15 connector, first choose your CPU Adapter Cable:

- If your video resolution is *not* higher than 1024 x 768 pixels, and if the CPU is within 20 ft. (6.1 m) of the Switch, you can use the **standard** (non-coaxial) cable with the product code **EHN051**.
- If your video resolution is higher than 1024 x 768, or if the CPU is farther than 20 ft. (6.1 m) from the Switch, you should use the **coaxial** cable with the product code **EHN282**. (This cable will come with keyboard and mouse adapters that you will not use.)

When you have the correct cable, hook it up to the ServSwitch Ultra and the CPU this way, as shown in Figure 11 on the next page:

- Plug the cable's **DB25**  connector into one of the Switch's numbered CPU ports.
- Plug the cable's **6-pin mini-DIN**  connector with the "**MOUSE**" label on it into the CPU's mouse port.
- Plug the cable's **unlabeled 6-pin mini-DIN**  connector into the CPU's keyboard port.
- Plug the cable's **HD15**  connector into the CPU's video port.

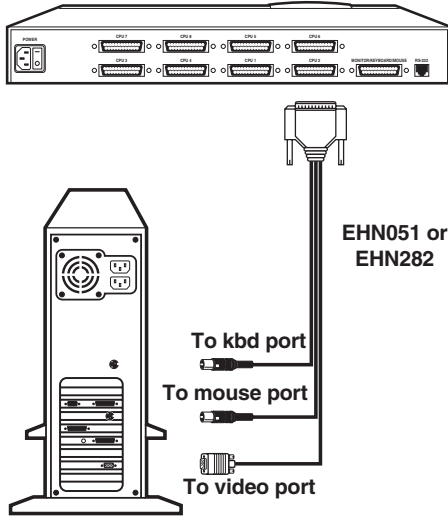





Figure 11. PS/2 type CPU connections.

4.2 IBM PC/AT COMPATIBLE KEYBOARD PORT, RS-232 SERIAL MOUSE PORT, VGA TYPE VIDEO PORT





If a CPU's keyboard port is PC/AT compatible, its mouse port is an RS-232 serial type, and its video port is a VGA, SVGA, XGA, or compatible type with an HD15 connector, first choose your CPU Adapter Cable:

- If your video resolution is *not* higher than 1024 x 768 pixels, and if the CPU is within 20 ft. (6.1 m) of the Switch, you can use the **standard** (non-coaxial) cable with the product code **EHN048**.
- If your video resolution is higher than 1024 x 768, or if the CPU is farther than 20 ft. (6.1 m) from the Switch, you should use the **coaxial** cable with the product code **EHN282**, including the adapters that come with it.

If you use the **EHN048**, hook it up to the ServSwitch Ultra and the CPU this way, as shown in Figure 12 on the next page:

- Plug the cable's **DB25**  connector into one of the Switch's numbered CPU ports.
- Plug the cable's **DB9**  connector into the CPU's mouse port.
- Plug the cable's **5-pin DIN**  connector into the CPU's keyboard port.
- Plug the cable's **HD15**  connector into the CPU's video port.

If you use the **EHN282**, hook it up to the ServSwitch Ultra and the CPU this way, as shown in Figure 13 on the next page:

- Plug the cable's **DB25**  connector into one of the Switch's numbered CPU ports.
- Plug the cable's **6-pin mini-DIN**  connector with the "**MOUSE**" label on it into the 6-pin mini-DIN end of the included mouse adapter. Then plug the DB9 end of the adapter into the CPU's mouse port.
- Plug the cable's **unlabeled 6-pin mini-DIN**  connector into the 6-pin mini-DIN end of the included keyboard adapter. Then plug the 5-pin DIN end of the adapter into the CPU's keyboard port.
- Plug the cable's **HD15**  connector into the CPU's video port.

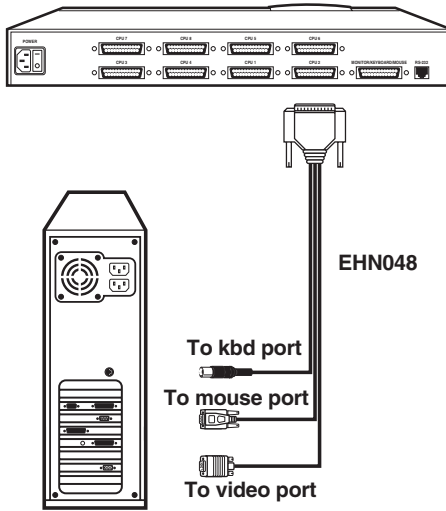

Figure 12. PC/AT type CPU connections (standard cable).

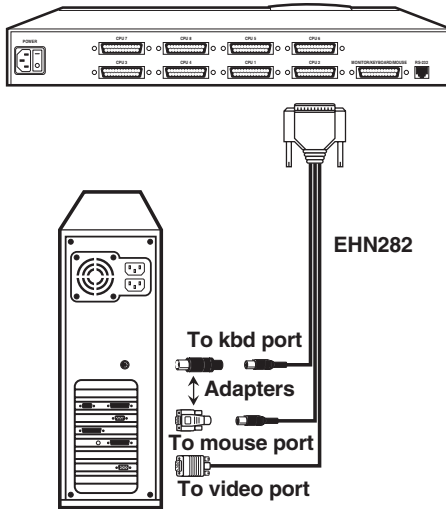





Figure 13. PC/AT type CPU connections (coaxial cable).

4.3 IBM PS/2 COMPATIBLE KEYBOARD AND MOUSE PORTS, RS/6000 VIDEO PORT

If a CPU's keyboard and mouse ports are IBM PS/2 compatible (which includes current RS/6000 CPUs), and its video port is an RS/6000 type with a 13W3 connector, use the coaxial CPU Adapter Cable **EHN520**. Hook this cable up to the ServSwitch Ultra and the CPU this way, as shown in Figure 14:

- Plug the cable's **DB25**  connector into one of the Switch's numbered CPU ports.
- Plug the cable's **6-pin mini-DIN**  connector with the "MOUSE" label on it into the CPU's mouse port.
- Plug the cable's **unlabeled 6-pin mini-DIN**  connector into the CPU's keyboard port.
- Plug the cable's **13W3**  connector into the CPU's video port.

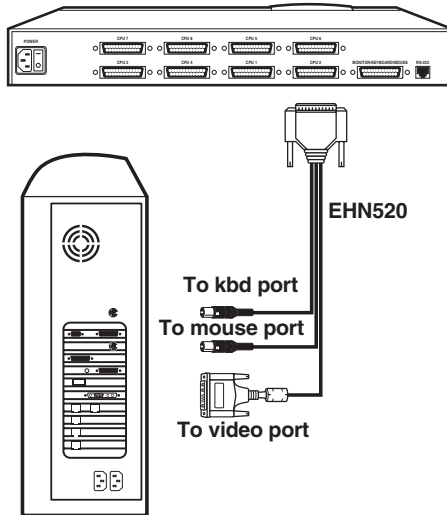





Figure 14. RS/6000 type CPU connections.

4.4 IBM PS/2 COMPATIBLE KEYBOARD AND MOUSE PORTS, SGI VIDEO PORT

If a CPU's keyboard and mouse ports are IBM PS/2 compatible (which includes current SGI CPUs), and its video port is an SGI type with a 13W3 connector, use the coaxial CPU Adapter Cable **EHN500**. Hook this cable up to the ServSwitch Ultra and your equipment this way, as shown in Figure 15:

- Plug the cable's **DB25**  connector into one of the Switch's numbered CPU ports.
- Plug the cable's **6-pin mini-DIN**  connector with the "MOUSE" label on it into the CPU's mouse port.
- Plug the cable's **unlabeled 6-pin mini-DIN**  connector into the CPU's keyboard port.
- Plug the cable's **13W3**  connector into the CPU's video port.

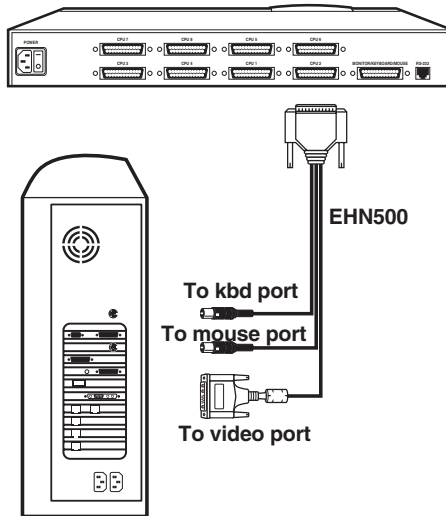





Figure 15. SGI type CPU connections.

4.5 SUN COMPATIBLE KEYBOARD, MOUSE, AND VIDEO PORTS

If a CPU's keyboard and mouse ports are Sun Microsystems compatible, and its video port is an Sun type with a 13W3 connector, use the coaxial CPU Adapter Cable **EHN206**. Hook this cable up to the ServSwitch Ultra and your equipment this way, as shown in Figure 16:

- Plug the cable's **DB25**  connector into one of the Switch's numbered CPU ports.
- Plug the cable's **8-pin mini-DIN**  connector into the CPU's keyboard port.
- Plug the cable's **13W3**  connector into the CPU's video port.

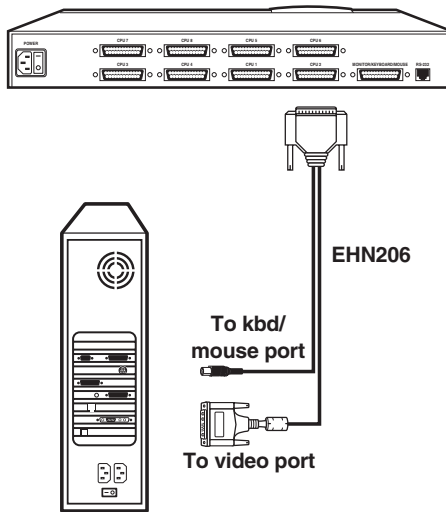





Figure 16. Sun type CPU connections (Sun video).

4.6 SUN COMPATIBLE KEYBOARD AND MOUSE PORTS, VGA TYPE VIDEO PORT

If a CPU's keyboard and mouse ports are Sun Microsystems compatible, and its video port is a VGA, SVGA, XGA, or compatible type with an HD15 connector, use the coaxial CPU Adapter Cable **EHN515**. Hook this cable up to the ServSwitch Ultra and your equipment this way, as shown in Figure 17:

- Plug the cable's **DB25**  connector into one of the Switch's numbered CPU ports.
- Plug the cable's **8-pin mini-DIN**  connector into the CPU's keyboard port.
- Plug the cable's **HD15**  connector into the CPU's video port.

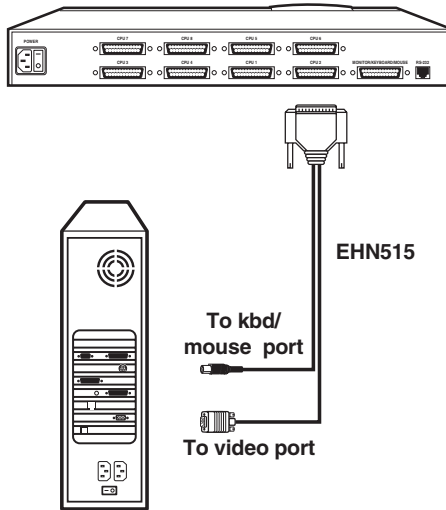





Figure 17. Sun type CPU connections (VGA video).

4.7 NON-G3 MAC COMPATIBLE KEYBOARD, MOUSE, AND VIDEO PORTS

If a CPU's keyboard and mouse ports are both Apple Macintosh compatible, and its video port is a non-G3 Mac type with a DB15 connector, first choose your CPU Adapter Cable:

- If your video resolution is *not* higher than 1024 x 768 pixels, and if the CPU is within 20 ft. (6.1 m) of the Switch, you can use the **standard** (non-coaxial) cable with the product code **EHN215**.
- If your video resolution is higher than 1024 x 768, or if the CPU is farther than 20 ft. (6.1 m) from the Switch, you should use the **coaxial** cable with the product code **EHN208**.

When you have the correct cable, hook it up to the ServSwitch Ultra and the CPU this way, as shown in Figure 18:

- Plug the cable's **DB25**  connector into one of the Switch's numbered CPU ports.
- Plug the cable's **4-pin mini-DIN**  connector into the CPU's keyboard port.
- Plug the cable's **DB15**  connector into the CPU's video port.

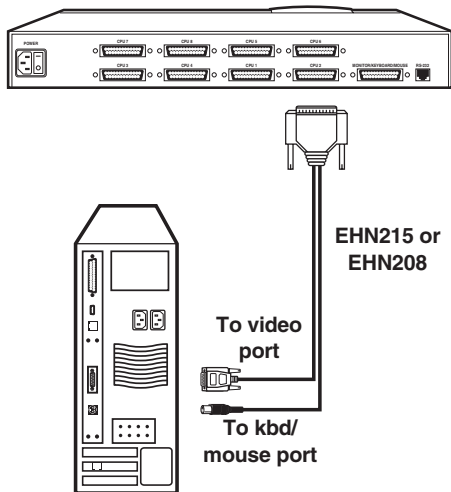





Figure 18. Non-G3 Mac type CPU connections.

4.8 MAC G3 COMPATIBLE KEYBOARD, MOUSE, AND VIDEO PORTS

If a CPU's keyboard and mouse ports are both Apple Macintosh compatible, and its video port is a Mac G3 type with an HD15 connector, first choose your CPU Adapter Cable:

- If your video resolution is *not* higher than 1024 x 768 pixels, and if the CPU is within 20 ft. (6.1 m) of the Switch, you can use the **standard** (non-coaxial) cable with the product code **EHN550**.
- If your video resolution is higher than 1024 x 768, or if the CPU is farther than 20 ft. (6.1 m) from the Switch, you should use the **coaxial** cable with the product code **EHN560**.

When you have the correct cable, hook it up to the ServSwitch Ultra and the CPU this way, as shown in Figure 19:

- Plug the cable's **DB25**  connector into one of the Switch's numbered CPU ports.
- Plug the cable's **4-pin mini-DIN**  connector into the CPU's keyboard port.
- Plug the cable's **HD15**  connector into the CPU's video port.

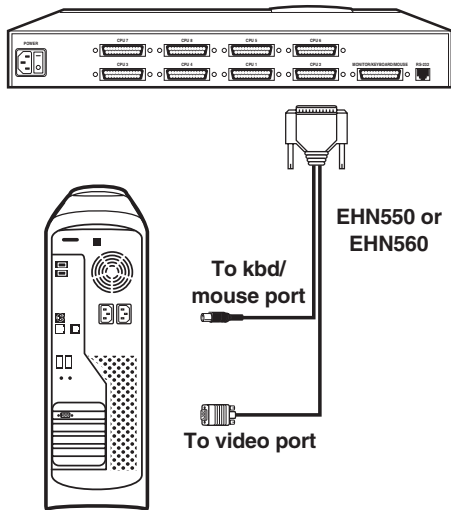



Figure 19. Mac G3 type CPU connections.

5. The RS-232 Connection (Required for Upgrading Firmware, Optional Otherwise)

To attach the ServSwitch Ultra's RS-232 port to the RS-232 serial port of a PC or modem for upgrading firmware (required) or for out-of-band port switching and diagnostics (optional), you will need a 4- or 6-wire flat-satin modular cable and a modular adapter:

- If you are connecting the Switch directly to a **DB9 male**  computer serial port, use the 4-wire cable and the DB9 female adapter that came with the Switch, as shown in Figure 20. (If you lose the cable, you can replace it with our product code **EL04MS**. If you lose the adapter, you can replace it with our product code **FA043**.)

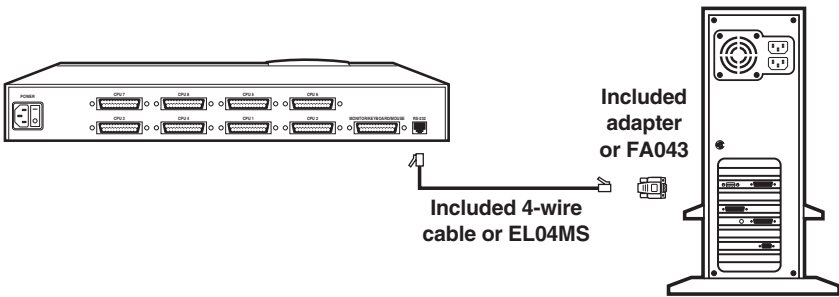



Figure 20. RS-232 connection to DB9 male computer port.

- If you are connecting the Switch directly to a **DB25 male**  computer serial port, use the 4-wire cable that came with the Switch and the DB25 female adapter **FA044**, as shown in Figure 21. (If you lose the cable, you can replace it with our product code **EL04MS**.)

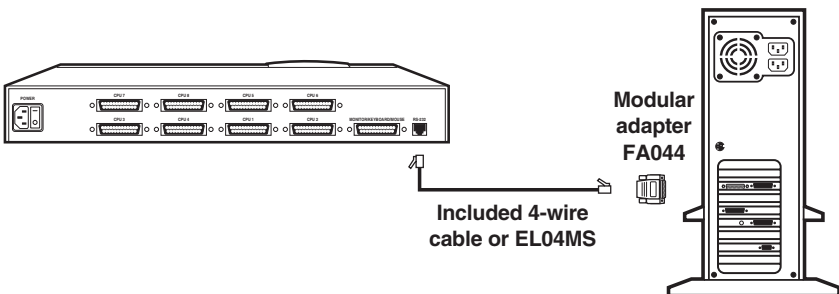

Figure 21. RS-232 connection to DB25 male computer port.

- If you are connecting the Switch to a computer at another site through a **modem** with a **DB25 female** serial port, use the 6-wire cable **EL06MS** and the DB25 male adapter **FA042**, as shown in Figure 22.

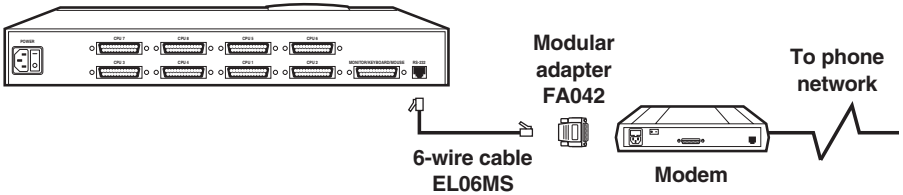

Figure 22. RS-232 connection to DB25 male computer port.

6. The Power Connection

Attach the **outlet end** of the included power cord into the Switch. Attach the **plug end** of the cord to a wall outlet. See Figure 23.

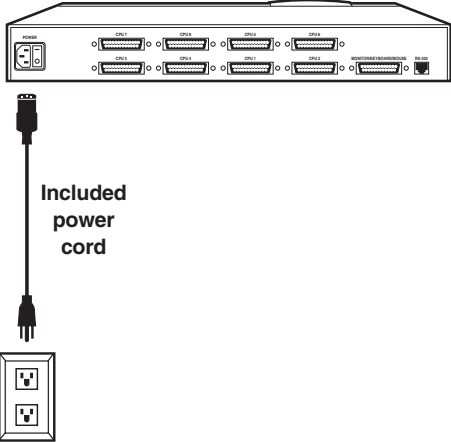



Figure 23. The power connection.

NOTES



© Copyright 2000. Black Box Corporation. All rights reserved.

BLACK BOX and the  logo are registered trademarks, and ServSwitch and ServSwitch Ultra are trademarks, of Black Box Corporation.

Apple, Mac, and Macintosh are registered trademarks of Apple Computer, Inc.

IBM, PC/AT, PS/2, and RS/6000 are registered trademarks of International Business Machines Corporation.

Microsoft and IntelliMouse are trademarks or registered trademarks of Microsoft Corporation in the United States and/or other countries.

SGL is a registered trademark of SGL.

Sun and Sun Microsystems are registered trademarks of Sun Microsystems, Inc. in the United States and other countries.

Any other trademarks mentioned in this document are acknowledged to be the property of the trademark owners.

**CUSTOMER
SUPPORT
INFORMATION**

Order **toll-free** in the U.S. 24 hours, 7 A.M. Monday to midnight Friday: **877-877-BBOX**
FREE technical support, 24 hours a day, 7 days a week: Call **724-746-5500** or fax **724-746-0746**
Mail order: **Black Box Corporation**, 1000 Park Drive, Lawrence, PA 15055-1018
Web site: **www.blackbox.com** • E-mail: **info@blackbox.com**