



© Copyright 1999. Black Box Corporation. All rights reserved.

1000 Park Drive • Lawrence, PA 15055-1018 • 724-746-5500 • Fax 724-746-0746



NOVEMBER 1999

IC525A-F

IC525AE-F

IC525A-M

IC525AE-M

IC526A-F

IC526AE-F

IC526A-M

IC526AE-M

Async RS-232 to RS-485 Interface Converter with Opto Isolation

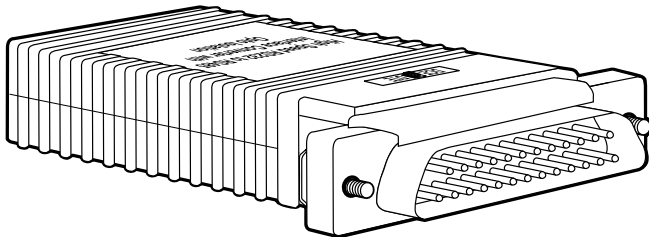

CUSTOMER SUPPORT INFORMATION

Order **toll-free** in the U.S. 24 hours, 7 A.M. Monday to midnight Friday: **877-877-BBOX**
FREE technical support, 24 hours a day, 7 days a week: Call **724-746-5500** or fax **724-746-0746**
Mail order: **Black Box Corporation**, 1000 Park Drive, Lawrence, PA 15055-1018
Web site: www.blackbox.com • E-mail: info@blackbox.com

**FEDERAL COMMUNICATIONS COMMISSION
AND
CANADIAN DEPARTMENT OF COMMUNICATIONS
RADIO FREQUENCY INTERFERENCE STATEMENTS**

This equipment generates, uses, and can radiate radio frequency energy and if not installed and used properly, that is, in strict accordance with the manufacturer's instructions, may cause interference to radio communication. It has been tested and found to comply with the limits for a Class A computing device in accordance with the specifications in Subpart J of Part 15 of FCC rules, which are designed to provide reasonable protection against such interference when the equipment is operated in a commercial environment. Operation of this equipment in a residential area is likely to cause interference, in which case the user at his own expense will be required to take whatever measures may be necessary to correct the interference.

Changes or modifications not expressly approved by the party responsible for compliance could void the user's authority to operate the equipment.

This digital apparatus does not exceed the Class A limits for radio noise emission from digital apparatus set out in the Radio Interference Regulation of Industry Canada.

Le présent appareil numérique n'émet pas de bruits radioélectriques dépassant les limites applicables aux appareils numériques de classe A prescrites dans le Règlement sur le brouillage radioélectrique publié par Industrie Canada.



The CE symbol on your equipment indicates that it complies with the Electromagnetic Compatibility (EMC) directive and Low Voltage Directive (LVD) of the Union European (EU).

**NORMAS OFICIALES MEXICANAS (NOM)
ELECTRICAL SAFETY STATEMENT**

INSTRUCCIONES DE SEGURIDAD

1. Todas las instrucciones de seguridad y operación deberán ser leídas antes de que el aparato eléctrico sea operado.
2. Las instrucciones de seguridad y operación deberán ser guardadas para referencia futura.
3. Todas las advertencias en el aparato eléctrico y en sus instrucciones de operación deben ser respetadas.
4. Todas las instrucciones de operación y uso deben ser seguidas.
5. El aparato eléctrico no deberá ser usado cerca del agua—por ejemplo, cerca de la tina de baño, lavabo, sótano mojado o cerca de una alberca, etc..
6. El aparato eléctrico debe ser usado únicamente con carritos o pedestales que sean recomendados por el fabricante.
7. El aparato eléctrico debe ser montado a la pared o al techo sólo como sea recomendado por el fabricante.
8. Servicio—El usuario no debe intentar dar servicio al equipo eléctrico más allá a lo descrito en las instrucciones de operación. Todo otro servicio deberá ser referido a personal de servicio calificado.
9. El aparato eléctrico debe ser situado de tal manera que su posición no interfiera su uso. La colocación del aparato eléctrico sobre una cama, sofá, alfombra o superficie similar puede bloquea la ventilación, no se debe colocar en libreros o gabinetes que impidan el flujo de aire por los orificios de ventilación.

10. El equipo eléctrico deber ser situado fuera del alcance de fuentes de calor como radiadores, registros de calor, estufas u otros aparatos (incluyendo amplificadores) que producen calor.
11. El aparato eléctrico deberá ser connectado a una fuente de poder sólo del tipo descrito en el instructivo de operación, o como se indique en el aparato.
12. Precaución debe ser tomada de tal manera que la tierra fisica y la polarización del equipo no sea eliminada.
13. Los cables de la fuente de poder deben ser guiados de tal manera que no sean pisados ni pellizcados por objetos colocados sobre o contra ellos, poniendo particular atención a los contactos y receptáculos donde salen del aparato.
14. El equipo eléctrico debe ser limpiado únicamente de acuerdo a las recomendaciones del fabricante.
15. En caso de existir, una antena externa deberá ser localizada lejos de las líneas de energia.
16. El cable de corriente deberá ser desconectado del cuando el equipo no sea usado por un largo periodo de tiempo.
17. Cuidado debe ser tomado de tal manera que objetos liquidos no sean derramados sobre la cubierta u orificios de ventilación.
18. Servicio por personal calificado deberá ser provisto cuando:
 - A: El cable de poder o el contacto ha sido dañado; u
 - B: Objetos han caído o líquido ha sido derramado dentro del aparato; o
 - C: El aparato ha sido expuesto a la lluvia; o
 - D: El aparato parece no operar normalmente o muestra un cambio en su desempeño; o
 - E: El aparato ha sido tirado o su cubierta ha sido dañada.

TRADEMARKS

The trademarks mentioned in this manual are the sole property of their owners.

CONTENTS

1. Specifications	6
2. Introduction.	8
2.1 Description.	8
2.2 Features	8
3. Configuration	10
3.1 DIP Switches.	10
3.2 Jumpers.	14
4. Installation	15
4.1 Connection to the RS-485 Interface.	15
4.1.1 4-Wire Connection Using RJ-45.	15
4.1.2 2-Wire Connection Using RJ-45.	17
4.1.3 4-Wire Connection Using Terminal Blocks	17
4.1.4 2-Wire Connection Using Terminal Blocks	20
4.2 Daisychain Topology.	20
4.3 Connection to the RS-232 Interface.	21
4.4 Operating the Converter.	22
Appendix: RS-232 Pin Configurations.	23

1. Specifications

Distance—Up to 4000 ft. (1219.2 m)

Interface—RS-232 is DCE

Operation—4-wire full- or half-duplex,
2-wire half-duplex

Speed—Up to 115.2 kbps

Transmission Format—Asynchronous

Optical Isolation—2500 Vrms

RS-232 Interface—DB25, female

RS-422/485 Interface Options—RJ-45 or terminal
block

Connectors—IC525A-F: (1) DB25 female,
(1) terminal block with strain relief; IC525A-M:
(1) DB25 male, (1) terminal block with strain
relief; IC526A-F: (1) DB25 female, (1) RJ-45;
IC526A-M: (1) DB25 male, (1) RJ-45

Temperature—32 to 122 °F (0 to 50 °C)

Humidity—5 to 95%, non-condensing

Power—External power adapter, 5-VDC, 300 mA;
“AE” models accept 220-volt input power

Size—0.8"H x 2.1"W x 3.8"D (2 x 5.3 x 9.7 cm)

2. Introduction

2.1 Description

The Async RS-232 to RS-485 Interface Converter with Opto Isolation provides exceptional versatility in a compact package. The Converter comes with an external AC power adapter and supports asynchronous RS-232 data rates up to 115.2 kbps over one or two unconditioned twisted pairs.

The Converter can handle up to 32 terminal drops in a multipoint polling environment. You can set carrier to “constantly on,” “controlled by RTS,” or “controlled by DTR,” and the unit operates without echo.

The Converter uses a male or female DB25 connector for the RS-232 connection. Options for twisted pair include RJ-11, RJ-45 or terminal block connectors. 2500-Vrms optical isolators provide isolation between the RS-232 and RS-485 interfaces.

2.2 Features

- Operates asynchronously, point-to-point or multipoint, over 2 or 4 wires.

- Up to 32 multipoint device drops in a polling environment.
- Data rates to 115.2 kbps.
- Passes transmit and receive data.
- Operates via 5 V power supply.
- Operates without “echo.”
- Driver controlled as “constantly on,” “controlled by RTS,” or “controlled by DTR.”
- Compact size: 0.8"H x 2.1"W x 3.8"D (2 x 5.3 x 9.7 cm)
- Twisted pair connection via strain relief, RJ-11, or RJ-45.
- 2500 Vrms optical isolation.

3. Configuration

You can configure the Converter via a four-position DIP switch and two jumpers. **Figure 3-1** shows the location of the DIP switch and the two headers on the board.

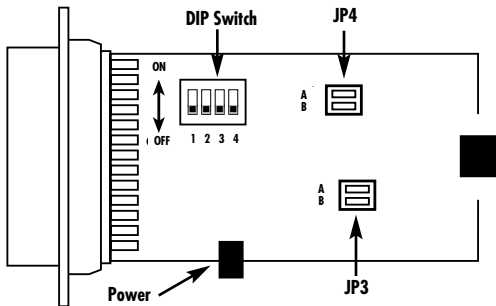

Figure 3-1. Location of the DIP Switch and Jumpers.

3.1 DIP Switches

The DIP switches control the transmit/receive signals on the Converter. **Table 3-1** shows the default configuration of the switches. **Table 3-2** shows the different switch and jumper combinations for the Converter. Also included in this section is a description of the switches.

Table 3-1. DIP Switch Default Settings.

Position	Function	Switch Function	
S1	RTS Control	OFF	No RTS control of transmitter
S2	DTR Control	OFF	No DTR control
S3	Reserved	OFF	N/A
S4	Transmitter Control	ON	Constantly ON

Table 3-2. Switch Combinations (NOTE: JP4B is N/A).

	S1-1† RTS Control	S1-2† DTR Control	S1-3 Always OFF Reserved	S1-4† RS-485 TX Always ON	JP4A*	JP3A and JP3B**
RS-485, full-duplex Transmitter is ON.	OFF	OFF		ON	OFF	Both OFF.
RS-485, full-duplex Transmitter is controlled by RTS.	ON	OFF		OFF	OFF	Both OFF.
RS-485, full-duplex Transmitter is controlled by DTR.	OFF	ON		OFF	OFF	Both OFF.
Half-duplex, 4-wire controlled by RTS.	ON	OFF		OFF	ON	Both OFF.
Half-duplex, 2-wire controlled by RTS.	ON	OFF		OFF	ON	Both ON.
Half-duplex, 4-wire controlled by DTR.	OFF	ON		OFF	ON	Both OFF.
Half-duplex, 2-wire controlled by DTR.	OFF	ON		OFF	ON	Both ON.

RS-232 TO RS-485 INTERFACE CONVERTER W/OPTO ISOLATION

KEY TO TABLE 3-2

†S1-1, S1-2, and S1-4: only one switch can be ON at any time. The other two must be OFF. We recommend that you disconnect the Converter while changing configurations.

*JP4A: If this jumper is off, only the RS-485 transmitter is controlled by RTS or DTR. If this jumper is ON, both the RS-485 transmitter and receiver are controller by RTS or DTR. When the transmitter is OFF, the receiver will be ON, and similarly, when the transmitter is ON, the receiver is OFF.

**JP3A and JP3B: Both jumpers are either ON or OFF. When the jumpers are ON, the RS-485 transmitter and receiver are connected directly together. This will only function in half-duplex mode. When both jumpers are OFF, the RS-485 transmitter and receiver are disconnected from each other. The Converter can operate in either half- or full-duplex, depending on the setting of JP4A.

SWITCH S1: RTS CONTROL

When Switch S1 is in the ON position, the DTE input signal RTS (Pin 4) controls the transmitter of the Converter. In this mode, when RTS is high, the Converter transmits data from the RS-232 port to the RS-485 port. Switch S2 and S4 must be in the OFF position when Switch S1 is ON.

S1	Setting
ON	RTS controls the transmitter
OFF	RTS control is OFF

SWITCH S2: DTR CONTROL

When Switch S2 is in the ON position, the DTE input signal DTR (Pin 20) controls the transmitter of the Converter. In this mode, when DTR is high, the Converter transmits data from the RS-232 port to the RS-485 port.

NOTE

Switches S1 and S4 must be OFF when Switch S2 is ON.

S2	Setting
ON	DTR controls the transmitter
OFF	DTR control is OFF

SWITCH S3: RESERVED

Switch S3 is reserved for future use and must remain OFF.

SWITCH S4: TRANSMITTER CONTROL

When Switch S4 is OFF, the input of RTS or DTR controls whether the unit can send data (based on the configuration of Switches S1 and S2). In this setting, and when the appropriate signal is high, the Converter can transmit data from the RS-232 port to the RS-485 port. When S4 is ON, the Converter's transmitter is always enabled.

S4 Setting

ON	Constant Transmitter
OFF	Transmitter is controlled by RTS or DTR

3.2 Jumpers

Jumper straps JP3 and JP4 control two-wire/four-wire and half-duplex/full-duplex operation, respectively.

Table 3-3. Interface Card Strap Summary.

Strap	Function	ON	OFF
JP3A	2-wire/4-wire mode	2-wire	4-wire*
JP3B	2-wire/4-wire mode	2-wire	4-wire*
JP4A	half- or full- duplex	Half-duplex	Full-duplex*
JP4B	Impedance	120 ohms (terminate)	12K ohms* (unterminate)

*Default settings.

4. Installation

Once you have properly set the configuration switches and jumpers, you are ready to connect the Converter to your system. This section explains how to properly connect the Converter to the RS-485 and RS-232 interfaces, and how to operate the Converter.

4.1 Connection to the RS-485 Interface

To function properly, the Converter must have one or two twisted pairs of metallic wire. These pairs should be “dry” (unconditioned) metallic wire, 24 AWG. We recommend using Category 5 cable.

For your convenience, the Converter is available with either a terminal block or an RJ-45 jack.

4.1.1 4-WIRE CONNECTION USING RJ-45

The RJ-45 connectors on the Converter’s RS-485 side are pre-wired for a standard telco wiring environment. The signal/pin relationships are shown in **Table 4-1**.

RS-232 TO RS-485 INTERFACE CONVERTER W/OPTO ISOLATION

Table 4-1. RJ-45 Signal/Pin Relationships.

RJ-45	Signal
1 -----	N/C
2 -----	GND*
3 -----	RCV-
4 -----	XMT+
5 -----	XMT-
6 -----	RCV+
7 -----	GND*
8 -----	N/C

*Connection to ground is optional.

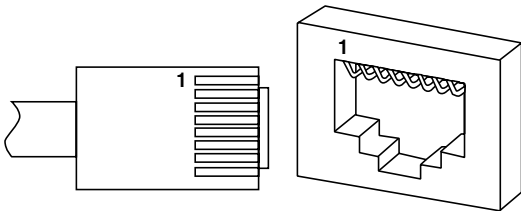

Figure 4-1. RJ-45 Connector Pin Orientation.

In most modular RS-485 applications, you'll need to use a crossover cable.

4.1.2 2-WIRE CONNECTION

Most RS-485 devices use a two-wire, half-duplex configuration. When using this configuration, first set the Converter to “two-wire” mode—then use *only the transmit (XMT) pair*, as shown in **Figure 4-2**.

Converter Signal	RS-485 Signal
XMT+ -----	>XMT-A
XMT- -----	>XMT-B

Figure 4-2. Crossover cable wiring.

4.1.3 4-WIRE CONNECTION USING TERMINAL BLOCKS

If you purchased the IC525A-F or IC525A-M, you will need to open the case to access the terminal blocks. The following instructions will tell you how to open the case, connect the bare wires to the terminal blocks, and fasten the strain-relief collar in place so that the wires won't pull loose.

1. If the case is not already open, open it now by twisting it open with a small plastic screwdriver.
2. Strip the outer insulation from the twisted pairs about one inch from the end as shown in **Figure 4-3**.

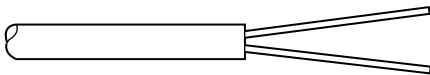

Figure 4-3. Stripping the Outer Insulation from the Twisted Pairs.

3. Strip back the insulation on each of the 2 twisted pair wires about $\frac{1}{4}$ inch as shown in **Figure 4-4**.

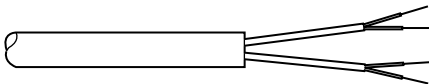

Figure 4-4. Stripping the Insulation on the 2 Twisted Pairs.

4. Place the cable through the end plate, and make a small loop in the cable and feed the cable under the tie wrap which is currently installed in the board. When you have completed this assembly, it should resemble the diagram shown in **Figure 4-5**. Connect one pair of wires to XMT+ and XMT- (transmit positive and negative) on the terminal block, making careful note of which color is positive, and which color is negative.

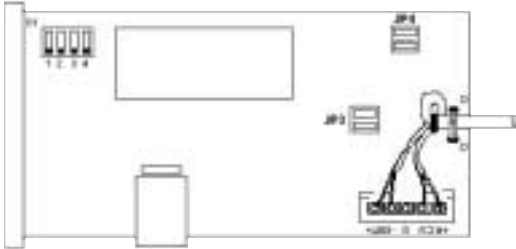

Figure 4-5. Completed Strain-Relief Assembly.

5. Connect the other pair of wires to RCV+ and RCV- (receive positive and negative) on both of the terminal blocks, again making careful note of which color is positive, and which is negative.

Ultimately, you will want to construct a two-pair cross-over cable that makes a connection with the RS-422/485 device, as shown below.

IC525A/6A		RS-422/485 Device
Signal	Terminal Block	Signal
XMT+	TB (5)	RCV+
XMT-	TB (4)	RCV-
RCV+	TB (1)	XMT+
RCV-	TB (2)	XMT-

4.1.4 2-WIRE CONNECTION USING TERMINAL BLOCKS

Most RS-485 devices employ a two-wire, half-duplex configuration. When using this configuration, be sure to first set the IC525A-F or IC525A-M to half-duplex mode by switching DIP switches and jumpers (refer to **Chapter 3** for this configuration)—then use only the transmit (XMT) pair, as shown below.

Converter Signal	RS-485 Signal
XMT+ -----	+
XMT- -----	-

4.2 Daisychain Topology

The Converter supports multipoint applications using a daisychain topology.

Using a daisychain topology, you can connect several Converters together in a master/slave arrangement. Maximum distance between the units will vary based upon the number of drops, data rate, wire gauge, etc.

Figure 4-6 shows how to wire the two-pair cables properly for a Converter daisychain topology.

NOTE

The ground connection is not needed.

Host	First Slave	Other Slave(s)
XMT+ -----	RCV+ -----	RCV+
XMT- -----	RCV- -----	RCV-
RCV+ -----	XMT+ -----	XMT+
RCV- -----	XMT- -----	XMT-

Figure 4-6. Daisychain Wiring for Converter Host and Slaves.

NOTE

This unit can be configured for line termination. If termination is required, a resistor will have to be externally connected.

4.3 Connection to the RS-232 Interface

Once you have properly configured the Converter and connected the twisted-pair wires correctly, simply plug the Converter directly into the DB25 port of the RS-232 DTE device. Remember to insert and tighten the two captive connector screws.

NOTE

If you must use a cable to connect the Converter to the RS-232 device, make sure it is a straight-through cable of the shortest possible length—we recommend 6-ft. (1.8-m) or less. If you are connecting it to a DCE device (such as a modem or a mux), a cross-over (null modem) cable is required. See **Appendix A** for pinning of a null modem cable.

4.4 Operating the Converter

Once the Converter is properly installed, it should operate transparently—as if it were a standard cable connection. Operating power is derived from the RS-232 data and control signals; there is no “ON/OFF” switch.

Appendix: Pin Configurations

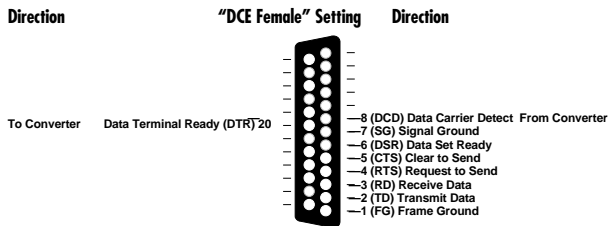

Figure A-1. RS-232 Pin Configuration.

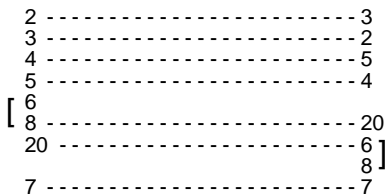

Figure A-2. Null Modem Pinning.

RS-232 TO RS-485 INTERFACE CONVERTER W/OPTO ISOLATION

RJ-45	Signal
1 -----	N/C
2 -----	GND*
3 -----	RCV-
4 -----	XMT+
5 -----	XMT-
6 -----	RCV+
7 -----	GND*
8 -----	N/C

*Connection to ground is optional

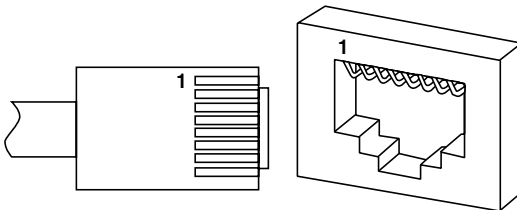

Figure A-2. RS-485 Pin Orientation.