

DCX3000 Switch

Share multiple computers with numerous users via standard structured cabling.



**Customer
Support
Information**

Order toll-free in the U.S.: Call 877-877-BBOX (outside U.S. call 724-746-5500)
FREE technical support 24 hours a day, 7 days a week: Call 724-746-5500 or fax 724-746-0746
www.blackbox.com • info@blackbox.com

Trademarks Used in this Manual

Black Box and the Double Diamond logo are registered trademarks, and ServSwitch is a trademark, of BB Technologies, Inc.

Mac is a registered trademark of Apple Computer, Inc.

Linux is registered trademark of Linus Torvalds.

Windows is a registered trademark of Microsoft Corporation.

NetWare is a registered trademark of Novell, Inc.

Sun is a trademark of Sun Microsystems, Inc.

Unix is a registered trademark of UNIX System Laboratories, Inc.

BSD is a registered trademark of UUNet Technologies, Inc.

Any other trademarks mentioned in this manual are acknowledged to be the property of the trademark owners.

We're here to help! If you have any questions about your application or our products, contact Black Box Tech Support at **724-746-5500** or go to **blackbox.com** and click on "Talk to Black Box." You'll be live with one of our technical experts in less than 60 seconds.

Federal Communications Commission and Industry Canada Radio Frequency Interference Statements

This equipment generates, uses, and can radiate radio-frequency energy, and if not installed and used properly, that is, in strict accordance with the manufacturer's instructions, may cause interference to radio communication. It has been tested and found to comply with the limits for a Class A computing device in accordance with the specifications in Subpart B of Part 15 of FCC rules, which are designed to provide reasonable protection against such interference when the equipment is operated in a commercial environment. Operation of this equipment in a residential area is likely to cause interference, in which case the user at his own expense will be required to take whatever measures may be necessary to correct the interference.

Changes or modifications not expressly approved by the party responsible for compliance could void the user's authority to operate the equipment.

This digital apparatus does not exceed the Class A limits for radio noise emission from digital apparatus set out in the Radio Interference Regulation of Industry Canada.

Le présent appareil numérique n'émet pas de bruits radioélectriques dépassant les limites applicables aux appareils numériques de la classe A prescrites dans le Règlement sur le brouillage radioélectrique publié par Industrie Canada.

Instrucciones de Seguridad

(Normas Oficiales Mexicanas Electrical Safety Statement)

1. Todas las instrucciones de seguridad y operación deberán ser leídas antes de que el aparato eléctrico sea operado.
2. Las instrucciones de seguridad y operación deberán ser guardadas para referencia futura.
3. Todas las advertencias en el aparato eléctrico y en sus instrucciones de operación deben ser respetadas.
4. Todas las instrucciones de operación y uso deben ser seguidas.
5. El aparato eléctrico no deberá ser usado cerca del agua—por ejemplo, cerca de la tina de baño, lavabo, sótano mojado o cerca de una alberca, etc.
6. El aparato eléctrico debe ser usado únicamente con carritos o pedestales que sean recomendados por el fabricante.
7. El aparato eléctrico debe ser montado a la pared o al techo sólo como sea recomendado por el fabricante.
8. Servicio—El usuario no debe intentar dar servicio al equipo eléctrico más allá a lo descrito en las instrucciones de operación. Todo otro servicio deberá ser referido a personal de servicio calificado.
9. El aparato eléctrico debe ser situado de tal manera que su posición no interfiera su uso. La colocación del aparato eléctrico sobre una cama, sofá, alfombra o superficie similar puede bloquea la ventilación, no se debe colocar en libreros o gabinetes que impidan el flujo de aire por los orificios de ventilación.
10. El equipo eléctrico deber ser situado fuera del alcance de fuentes de calor como radiadores, registros de calor, estufas u otros aparatos (incluyendo amplificadores) que producen calor.
11. El aparato eléctrico deberá ser conectado a una fuente de poder sólo del tipo descrito en el instructivo de operación, o como se indique en el aparato.
12. Precaución debe ser tomada de tal manera que la tierra física y la polarización del equipo no sea eliminada.
13. Los cables de la fuente de poder deben ser guiados de tal manera que no sean pisados ni pellizcados por objetos colocados sobre o contra ellos, poniendo particular atención a los contactos y receptáculos donde salen del aparato.
14. El equipo eléctrico debe ser limpiado únicamente de acuerdo a las recomendaciones del fabricante.
15. En caso de existir, una antena externa deberá ser localizada lejos de las líneas de energía.
16. El cable de corriente deberá ser desconectado del cuando el equipo no sea usado por un largo periodo de tiempo.
17. Cuidado debe ser tomado de tal manera que objetos líquidos no sean derramados sobre la cubierta u orificios de ventilación.
18. Servicio por personal calificado deberá ser provisto cuando:
 - A: El cable de poder o el contacto ha sido dañado; u
 - B: Objetos han caído o líquido ha sido derramado dentro del aparato; o
 - C: El aparato ha sido expuesto a la lluvia; o
 - D: El aparato parece no operar normalmente o muestra un cambio en su desempeño; o
 - E: El aparato ha sido tirado o su cubierta ha sido dañada.

Contents

1. Specifications..... 6

2. Welcome..... 7

 2.1 Access permissions..... 7

3. Installation..... 8

 3.1 Connections..... 9

 3.1.1 Computer connections: Video 9

 3.1.2 Computer connections: USB..... 10

 3.1.3 Computer connections: Data link 10

 3.1.4 Switch connections: Computer links..... 11

 3.1.5 Reallocating ports..... 11

 3.1.6 Switch connections: User console links..... 11

 3.1.7 Switch connections: Network link..... 12

 3.1.8 Switch connections: Serial options port..... 12

 3.1.9 Switch connections: Power 13

 3.1.10 Console connections: Video..... 14

 3.1.11 Console connections: USB..... 15

 3.1.12 Console connections: Audio 15

 3.1.13 Console connections: Data link 16

 3.1.14 Console connections: Options port..... 16

 3.1.15 Console connections: Power 17

4. Configuration..... 18

 4.1. Accessing DCX Matrix 18

 4.2 Using DCX Matrix..... 20

 4.3 Quick guide to creating a new installation 21

 4.4 The Control page..... 22

 4.5 The Configure pages 23

 4.6 Configure > Consoles 26

 4.7 Configure > Consoles > Receivers..... 28

 4.8 Configure > Computers..... 30

 4.9 Configure > Computers > Transmitters..... 32

 4.10 Reallocating ports 34

 4.11 The Users page..... 35

 4.12 The Maintenance pages 36

 4.13 Resetting and recovering 39

5. Operation..... 41

 5.1 Viewing the OSD 41

 5.2 Choosing a computer 41

 5.3 Indicators..... 42

Appendix A. Safety Information 44

1. Specifications

Approvals: CE, FCC

Hardware Compatibility: All computers with DVI-D/DisplayPort digital video and USB interfaces

Software Compatibility: Operates with all known software and operating systems including Windows®, Linux®, Unix®, BSD, all Sun® OS, all Mac® OS, NetWare®, etc.

Operating Temperature: 32 to 104°F (0 to 40°C)

2. Welcome

Thank you for choosing the Black Box DCX3000 system. This adaptive system makes sharing numerous host computers among multiple users straightforward and flexible. Every computer is linked, via its USB and video ports, to a compact DCX3000 SAM module while each set of peripherals are connected to a DCX3000 Remote module (to form *Consoles*).

The various computers and consoles are then linked, via standard CAT7 cable, to a central DCX3000 Switch. Each user can then, subject to the privileges granted by the admin, gain quick access to any of the required computers.

An integral part of the DCX3000 Switch is the DCX Matrix, a browser-based configuration and management tool that allows one or more remote admin user(s) to monitor and maintain all aspects of operation.

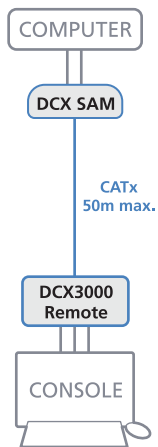
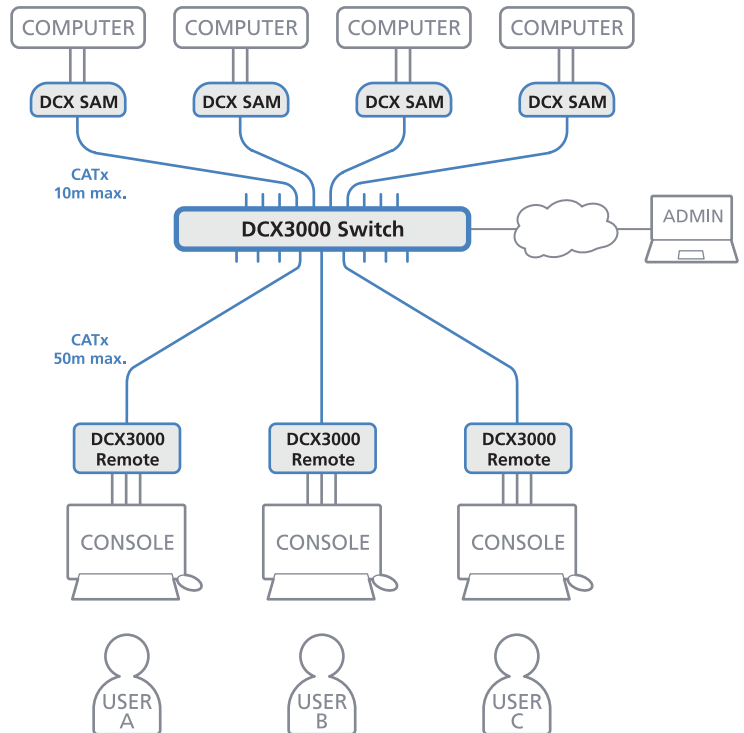

If required, computers and consoles can be individually connected in order to take advantage of the DCX3000 extender properties without the switching.

2.1 Access permissions

The DCX3000 Switch uses a system of hierarchal Access permissions to mediate between numerous consoles and multiple computers. Each console is granted the use of up to four types of access permissions to each computer, most of which influence how other users can gain simultaneous access to the same computer. The four access permissions, and their effects on other console users are as follows:



VIEW ONLY

The console user can view the chosen computer's output but cannot alter it.

Once selected, other consoles can simultaneously use VIEW ONLY, SHARED ACCESS or EXCLUSIVE for the same computer.



SHARED ACCESS

The console user can view and control the chosen computer's output.

Once selected, other consoles can simultaneously use VIEW ONLY or SHARED ACCESS for the same computer.



EXCLUSIVE

The console user can view and control the chosen computer's output.

Once selected, other consoles can simultaneously use VIEW ONLY for the same computer.



PRIVATE

The console user can view and control the chosen computer's output.

Once selected, all other consoles are completely locked out from the same computer.

Note: The hierarchy of permissions shown here increases from left to right.

3. Installation

Please consider the following important points when planning the position of the DCX3000 modules:

- If used, position the DCX3000 Switch in a central position that serves the host systems and user modules without exceeding the maximum link lengths. It will also require a source of mains power.
- Situate each DCX3000 Remote module close to the peripherals to which it will be connected and near to a source of mains power.
- Consult the precautions listed within the Safety information section.

3.1 Connections

Connections do not need to be carried out in the order given within this guide, however, where possible connect the power in as a final step. Connections are split into the following three areas:

- **Computer connections** - a DCX3000 SAM module links to each computer.
- **Switch connections** - when used, a DCX3000 Switch unit sits at the heart of the system.
- **Console connections** - the peripherals (keyboard, display, etc.) connect to DCX3000 Remote modules.

3.1.1 Computer connections: Video

Two types of DCX3000 SAM modules are available:

- DVI-D and USB,
- or
- DisplayPort and USB.

If a computer has more than one video output, use additional DCX3000 SAM modules to separately link the alternative video stream(s) with other ports on the DCX3000 Switch.

3.1.1.1 To connect the video port

- 1 Connect the video lead of the DCX3000 SAM to the DVI-D or DisplayPort video port of the host computer.

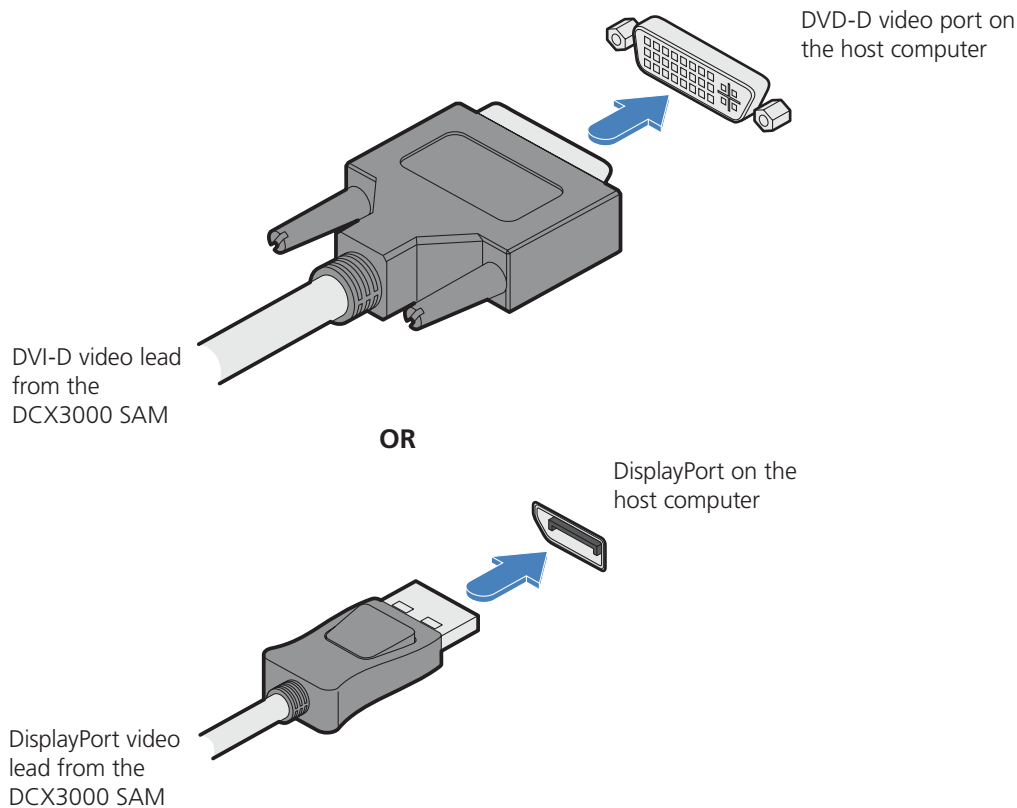

3.1.2 Computer connections: USB

Each DCX3000 SAM module requires a single USB connection to the computer. This provides essential power for the DCX3000 SAM module in addition to the USB signals. Each DCX3000 Remote module acts as a USB 2.0 hub and thus provides four sockets for peripherals.

3.1.2.1 To connect the USB port

- 1 Connect the USB cable of the DCX3000 SAM module to a vacant USB socket on your host computer.

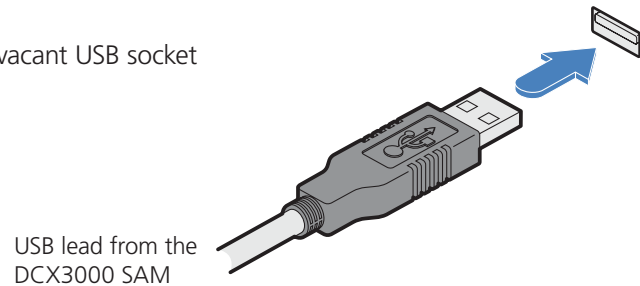

3.1.3 Computer connections: Data link

Each DCX3000 SAM module is linked via a CATx cable either to a central DCX3000 Switch module (multi-system matrix installation) or directly to a DCX3000 Remote module (single system installation).

For best results use CAT7 cables to link all DCX3000 SAM modules. Maximum cable lengths:

- DCX3000 SAM to DCX3000 Switch - 32 feet (10m) maximum.
- DCX3000 SAM to DCX3000 Remote - 164 feet (50m) maximum.

3.1.2.2 To link the DCX3000 SAM module

- 1 Connect the RJ-45 plug of the link cable to the socket located at the end of the DCX3000 SAM module.

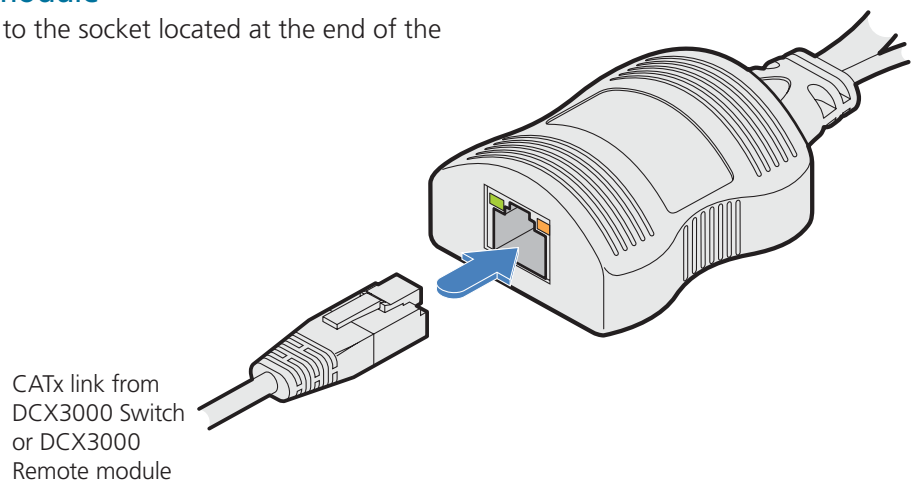

3.1.4 Switch connections: Computer links

When a DCX3000 Switch is used, it sits as the central matrix between the various host computers and the users. The host computer links are generally made via the sockets at the rear of the switch, although some host links can also be supported from the sockets on the front panel (see below).

3.1.4.1 To connect a host link

- 1 Connect the CAT7 cable from the remote DCX3000 SAM host module to a vacant RJ-45 socket on the rear panel of the DCX3000 Switch.

 These are NOT Ethernet/network ports and must NEVER be connected to any networking equipment.

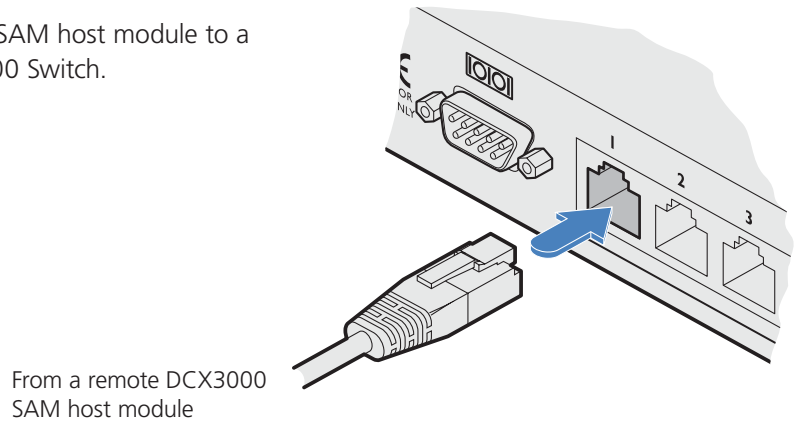

3.1.5 Reallocating ports

By default the DCX3000 Switch provides 20 computer ports along its rear panel and 10 user ports along its front panel. If necessary, these standard arrangements can be changed. See [Reallocating ports](#).

3.1.6 Switch connections: User console links

The user data links are generally made via the sockets at the front of the switch, although any of the rear panel sockets can also be converted to user ports (see above).

3.1.6.1 To connect a console link

- 1 Connect the CAT7 cable from the remote DCX3000 Remote module to a vacant RJ-45 socket on the front panel of the DCX3000 Switch.

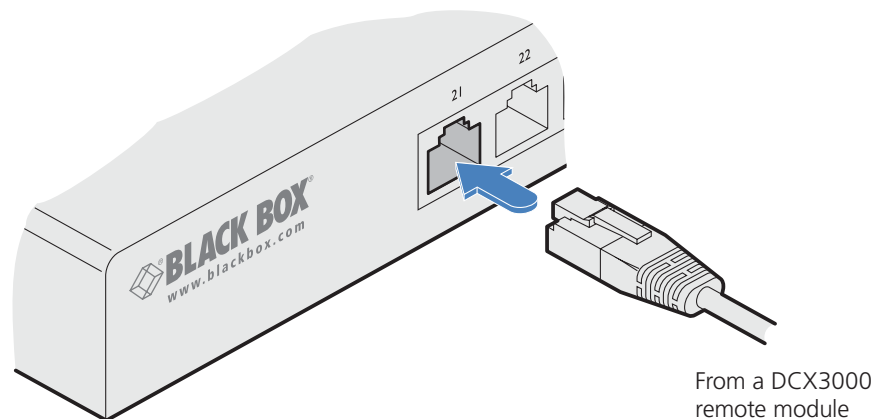

 These are NOT Ethernet/network ports and must NEVER be connected to any networking equipment.

3.1.7 Switch connections: Network link

All system configuration is carried out via an Ethernet link, allowing adjustments to be made by authorized admin users located next to the DCX3000 unit, or anywhere. The auto-sensing network port can determine between 10, 100Mbps or 1Gbps links and can also adjust to straight or cross-over cables.

3.1.7.1 To connect a network link

- 1 Connect the CATx cable from the nearest Ethernet switch or from a local computer.

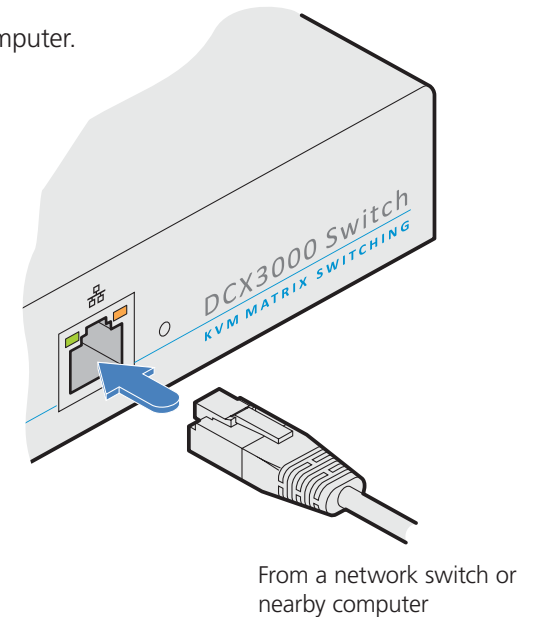

3.1.8 Switch connections: Serial options port

The options port is reserved for future use.

3.1.9 Switch connections: Power

Each DCX3000 Switch is supplied with a single power adapter but offers the facility to use a second input in order to provide operational redundancy. The DCX3000 unit can operate perfectly well from a single power adapter operating alone. When two adapters are connected, the unit will spread its load between them; should one power input fail, 100% of the load will be transferred to the other power adapter without a break in operation. Remote checking of the power inputs is possible at any time via the Maintenance page of the browser interface.

There is no on/off switch on the DCX3000 unit, so operation begins as soon as power is applied at either port.

3.1.9.1 To connect the power adapter

- 1 Attach the output plug of the supplied power adapter to either power input socket on the left side of the rear panel.

IMPORTANT: Please read and adhere to the electrical safety information given within the Safety information section of this guide. In particular, do not use an unearthed power socket or extension cable.

Note: Both the modules and the power supplies generate heat when in operation and will become warm to the touch. Do not enclose them or place them in locations where air cannot circulate to cool the equipment. Do not operate the equipment in ambient temperatures exceeding 40 degrees Centigrade. Do not place the products in contact with equipment whose surface temperature exceeds 40 degrees Centigrade.

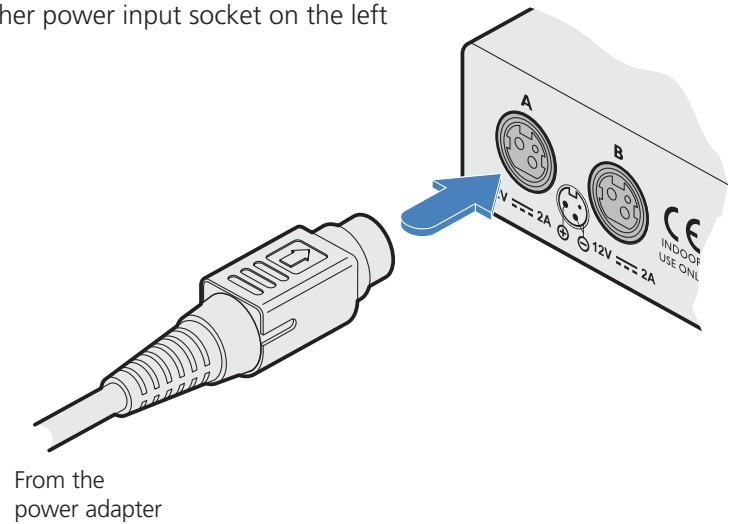

- 2 Connect the IEC connector of the supplied country-specific power cord to the socket of the power adapter.
- 3 Connect the power cord to a nearby main supply socket.
- 4 Where power redundancy is required, repeat steps 1 to 3 for a second power adapter.

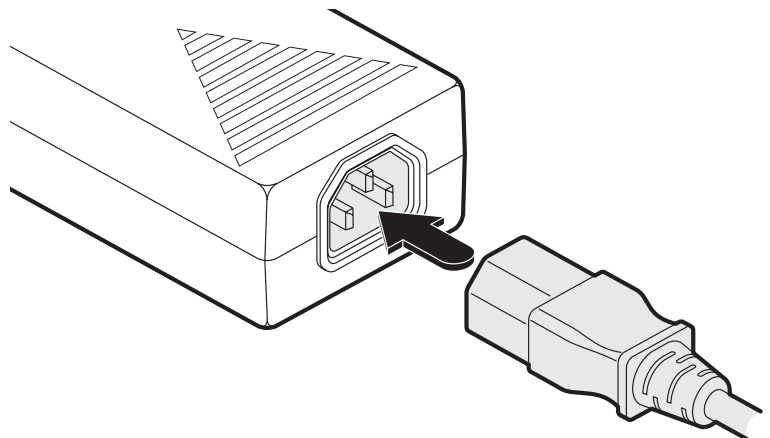

3.1.9.2 To disconnect the power adapter

- 1 Isolate the power adapter from the mains supply.

Note: If you are replacing one of dual power adapters during operation, it is not necessary to also remove power from the other adapter.

- 2 Grasp the outer body of the power adapter plug where it connects with the module.
- 3 Gently pull the body of the outer plug away from the module. As the body of the plug slides back, it will release from the socket and you can fully withdraw the whole plug.

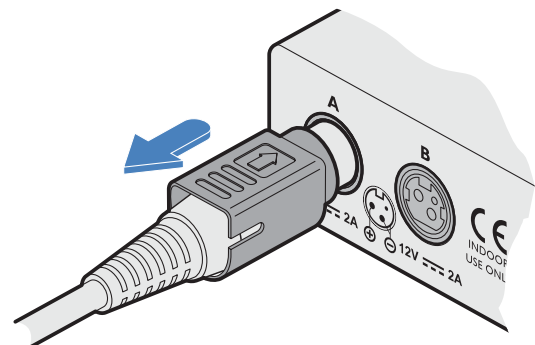

Gently pull back the plug outer body to release the lock

3.1.10 Console connections: Video

A Single Link DVI-D port is provided on the rear panel of the user module.

The DCX3000 Remote module supports one video display with pixel clocks up to 165MHz (equivalent to a maximum resolution of 1920 x 1200 at 60Hz - aka 'WUXGA').

If a second display is required to support a dual video installation, use another DCX3000 Remote module to drive the second display, and combine the two user modules into a single Console within the DCX Matrix configuration application.

3.1.10.1 To connect the video display

- 1 Connect the DVI-D video cable from your video display to the video output port on the rear panel of the user module.

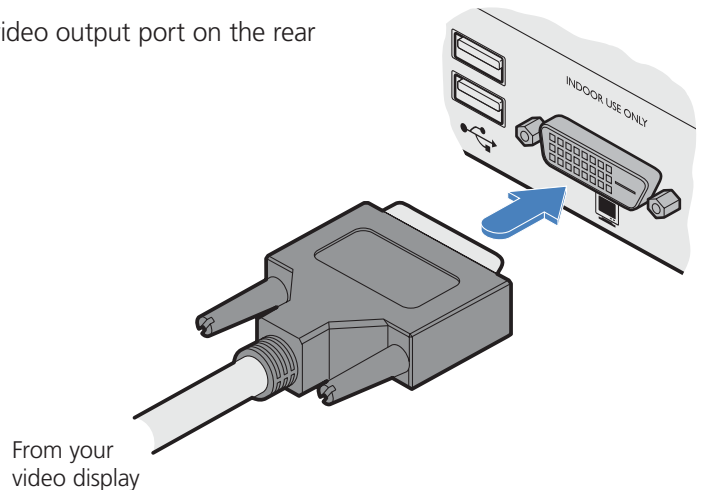

3.1.10.2 EDID management

The DCX3000 Switch provides a number of fixed EDID (Extended Display Identification Data) profiles that will suit a large number of video display configurations. If additional EDID definitions are required for your installation, you can clone new definitions from connected video displays and add these to the list of available definitions.

For details about cloning EDIDs from displays, see [Add EDID](#).

For details about applying an EDID to a particular computer, see [Configure > Computers > Transmitters](#).

3.1.10.3 DCX3000 Remote module switches

The two switches on the DCX3000 Remote module are reserved for future use and must both remain in the OFF position.

3.1.11 Console connections: USB

The DCX3000 Remote module contains a USB hub that can support up to four v1.1 or v2.0 USB devices (in any combination). All four USB sockets, two on the front panel and two on the rear, are identical in operation.

Note: In multi-head installations, the USB devices must be attached only to the DCX3000 Remote that drives the main display.

3.1.11.1 To connect USB devices

- 1 Connect your USB keyboard and mouse to any of the four sockets distributed on the front and rear panels of the user module.

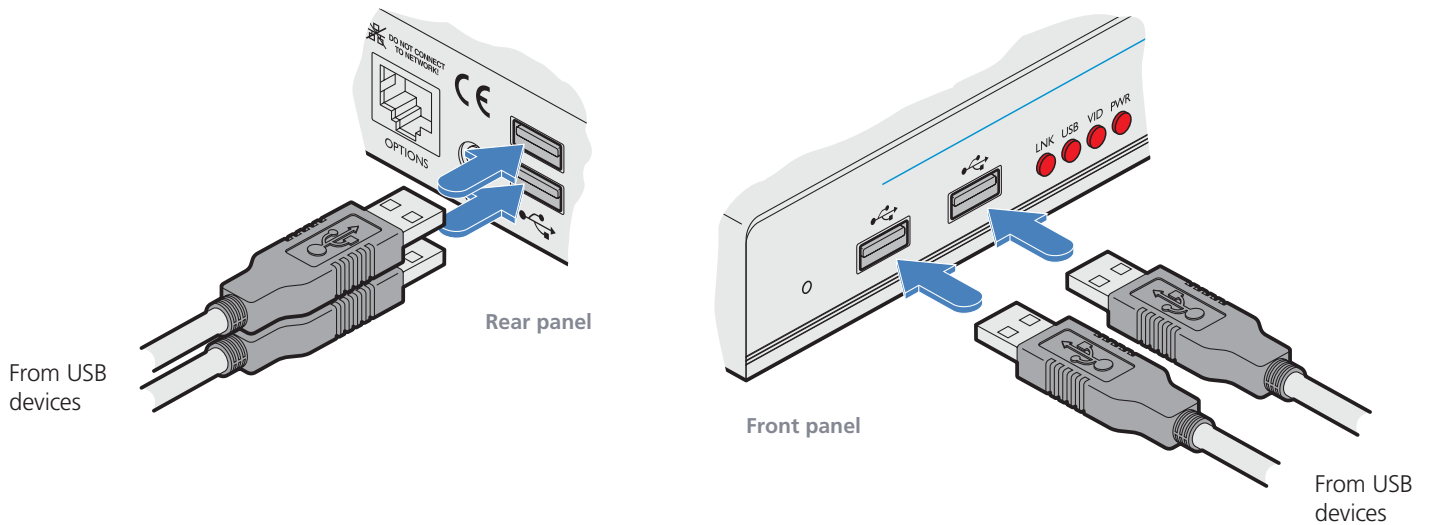

3.1.12 Console connections: Audio

The DCX3000 Remote module supports stereo speakers, headphones and also a microphone port. All audio devices are presented at the linked host computer as USB audio devices.



Note: In multi-head installations, the audio devices must be attached only to the DCX3000 Remote that drives the main display.

3.1.12.1 To connect your speakers

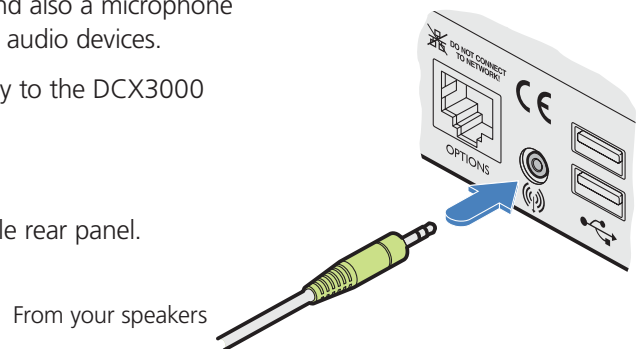
- 1 Connect your speakers to the audio line out socket on the user module rear panel.



3.1.12.2 To connect your headphones/ microphone

- 1 Connect your headphones to the socket labeled  on the user module front panel.
- 2 Connect your microphone to the socket labeled  on the user module front panel.

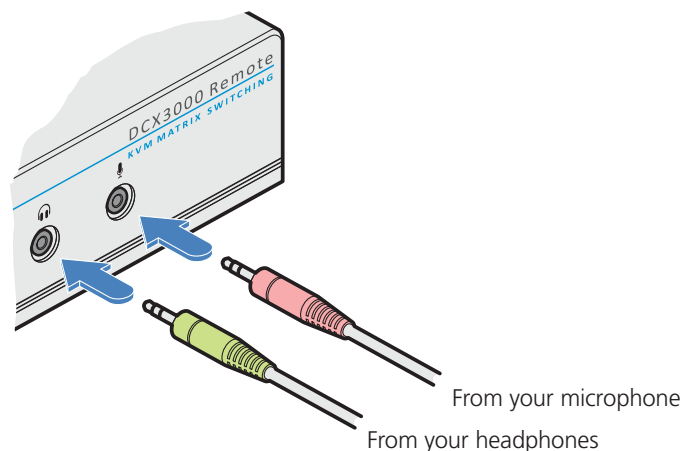

3.1.13 Console connections: Data link

Each DCX3000 Remote module is linked via a CATx cable either to a central DCX3000 Switch module (multi-system matrix installation) or directly to a DCX3000 SAM module (single system installation).

For best results use CAT7 cables to link all DCX3000 SAM modules - do not exceed 50 meters (164 feet).

3.1.13.1 To link the DCX3000 Remote module

- 1 Connect a suitable CATx cable to the LINK socket on the rear panel of the DCX3000 Remote module. Connect the other end of the cable to either a DCX3000 Switch or directly to a DCX3000 SAM host module.

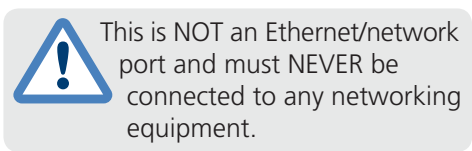

From DCX3000
Switch or DCX3000
SAM

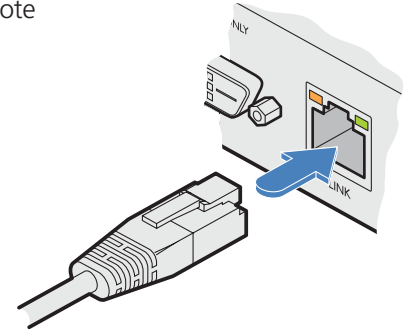

3.1.14 Console connections: Options port

The options port is reserved for future use.

3.1.15 Console connections: Power

There is no on/off switch on the DCX3000 Remote module, so operation begins as soon as power is applied. The supplied power adapter uses a locking-type plug to help prevent accidental disconnections; please follow the instructions given right whenever disconnecting a power adapter.

3.1.15.1 To connect the power adapter

- 1 Attach the output plug of the supplied power adapter to either power input socket on the rear panel of the DCX3000 Remote module.

IMPORTANT: Please read and adhere to the electrical safety information given within the Safety information section of this guide. In particular, do not use an unearthed power socket or extension cable.

Note: Both the modules and the power supplies generate heat when in operation and will become warm to the touch. Do not enclose them or place them in locations where air cannot circulate to cool the equipment. Do not operate the equipment in ambient temperatures exceeding 40 degrees Centigrade. Do not place the products in contact with equipment whose surface temperature exceeds 40 degrees Centigrade.

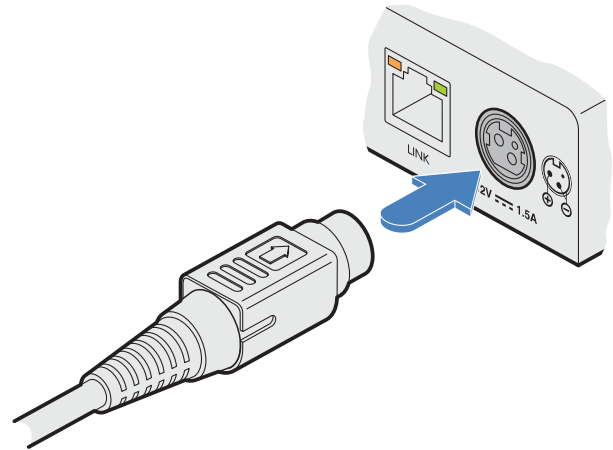

From the power adapter

- 2 Connect the IEC connector of the supplied country-specific power cord to the socket of the power adapter.
- 3 Connect the power cord to a nearby main supply socket.
- 4 Where power redundancy is required, repeat steps 1 to 3 for a second power adapter.

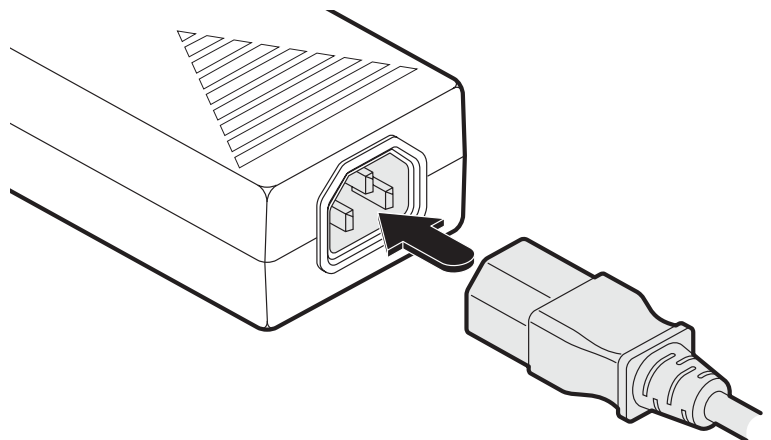

3.1.15.2 To disconnect the power adapter

- 1 Isolate the power adapter from the mains supply.
- 2 Grasp the outer body of the power adapter plug where it connects with the module.
- 3 Gently pull the body of the outer plug away from the module. As the body of the plug slides back, it will release from the socket and you can fully withdraw the whole plug.

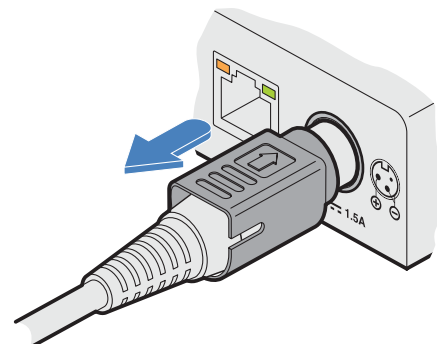

Gently pull back the plug outer body to release the lock

4. Configuration

4.1. Accessing DCX Matrix

DCX3000 Switches are configured via their network connections using an intuitive browser-based application, called DCX Matrix. This secure, password protected application is accessible by any authorized admin user, located anywhere.

4.1.1 To access DCX Matrix

- 1 Use a computer that is directly or indirectly (i.e. via a network switch) connected to the DCX3000 Switch. If you need to make a temporary connection, see below.
- 2 DHCP (*Dynamic Host Configuration Protocol*) is enabled by default. To find the IP address of the DCX Matrix interface, open the OSD on one of the connected user consoles.
- 3 If there is no DHCP on the network, after one minute a time out will occur and the default IP address **https://192.168.1.22** will be used.

Note: For security, DCX Matrix uses HTTPS by default with a self-signed certificate - Please ignore any warnings that may be displayed by your web browser.

- 4 If requested, enter your username and password to log on. *Note: The default username and password are **admin** and **password** respectively.*

The opening page of the DCX Matrix should be displayed:

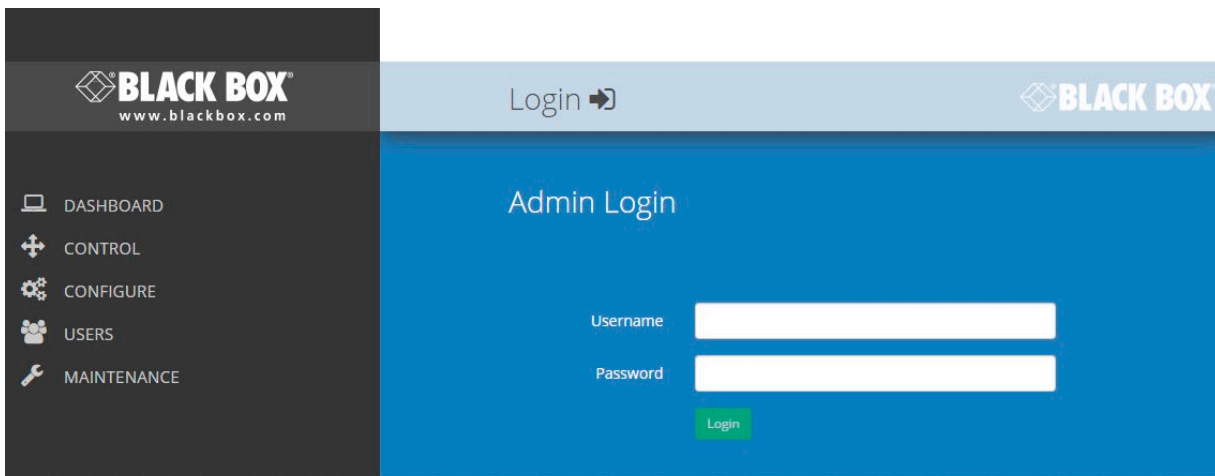

4.1.2 To temporarily connect a computer to the network port

- 1 If you need to make a temporary connection for configuration purposes, use a standard patch cable (cross-over or straight connections are both supported) to link the Ethernet 10/100 network port (📶) on the front panel of the DCX3000 Switch to your computer's network port.

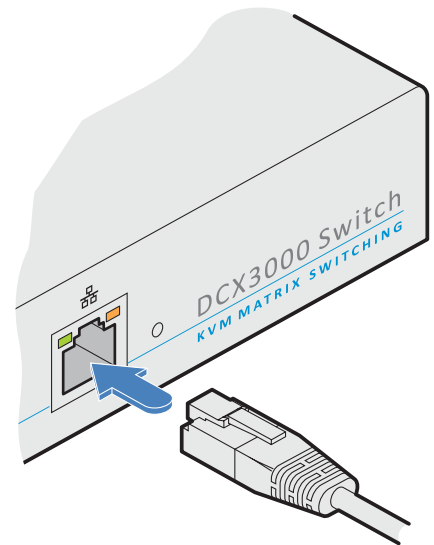

4.2 Using DCX Matrix

4.2.1 The Dashboard page

Once you have successfully logged in, DCX Matrix will show the dashboard page to provide a general overview of your DCX installation. You can also re-display this page by clicking the Dashboard entry in the menu:

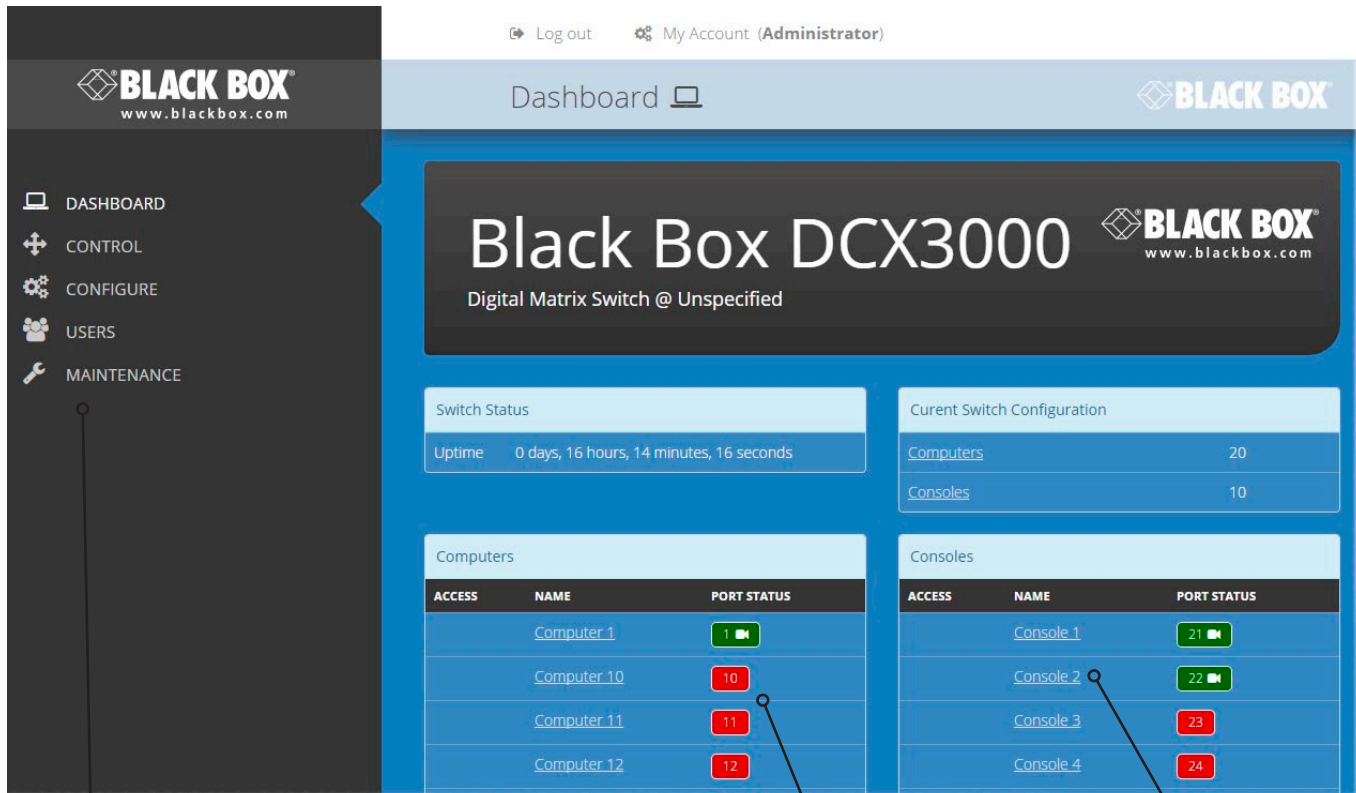

Click the required menu item to reveal the available page choices.

Colors are used to provide quick visual feedback. Here ports shown in green are operational while those in red are disconnected. Ports shown in white indicate that their modules require a firmware update.

Information and options are displayed within the main section of the page. Some items will provide further popup information when you hover your mouse pointer over them.

Note: It is not possible to leave DCX Matrix open for more than 24 hours.

4.3 Quick guide to creating a new installation

When creating a new DCX installation there are various tasks that need to be completed. This page provides a recommended 'to do list' of the stages that you need to perform.

4.3.1 Primary tasks

- Configure the networking details for the DCX3000 Switch See [Configure > Central Switch > Network](#)
- Ensure that the EDID definitions are appropriate for your installation See [Configure > Central Switch > Manage EDIDs](#)
 - If additional EDID definitions are required for your installation, you can clone new definitions from connected video displays and add these to the list of available definitions* See [Add EDID](#)
- Add the required consoles (either before or after they are connected) See [Configure > Consoles](#)
 - By default the DCX3000 Switch provides 20 computer ports along its rear panel and 10 user ports along its front panel. If necessary, these standard arrangements can be changed to suit your installation* See [Reallocating ports](#)
- Determine the access permissions for each console See [Access permissions](#)
- Add your computers (either before or after they are connected) See [Configure > Computers](#)
- Add the users and define their login details See [The Users Page](#)

4.3.2 Secondary tasks

- Optionally make changes to the OSD settings See [Configure > Central Switch > OSD Settings](#)
- Name the switch and add description and location details See [Configure > Central Switch > General](#)

4.4 The Control page

The Control page provides a Connection map that allows the admin user to view and affect how consoles are connected to the various computers. This page is particularly useful when managing video-only installations.

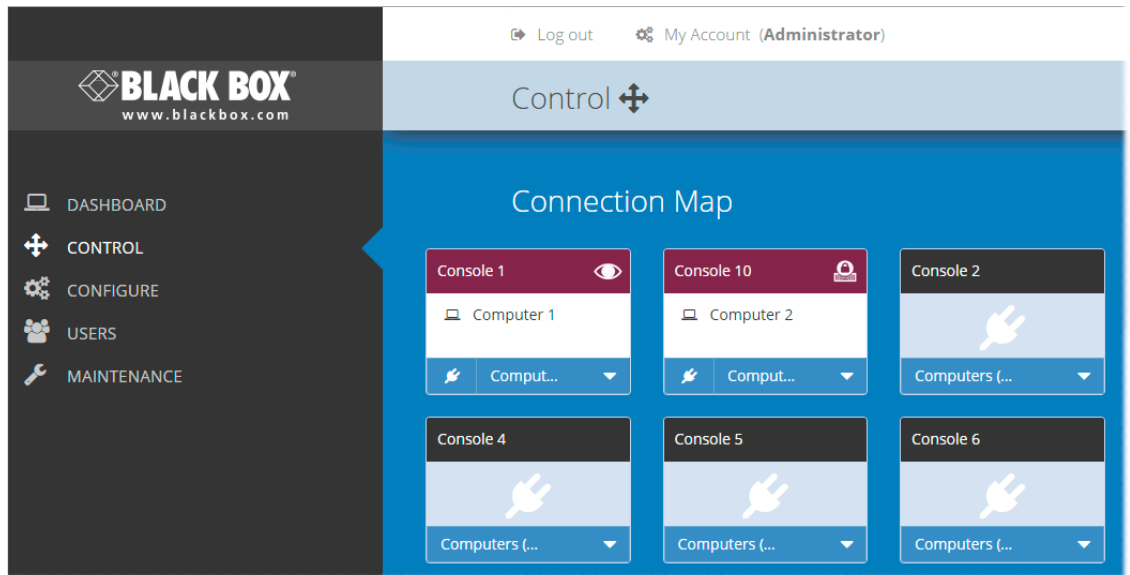

4.4.1 To connect a console

1 Click the down arrow on the console entry to reveal the list of computers that it is authorized to access.

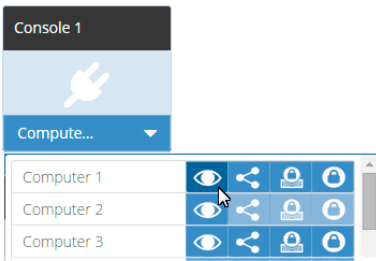

2 Click the appropriate connection icon adjacent to the required computer:

- **View only** - console user can view a computer's output but not alter it,
- **Shared access** - console user can view and control a computer along with other consoles,
- **Exclusive** - multiple console users can view a computer but only one can control it,

or

- **Private** - console user can view and control the computer privately while other users are locked out.

For further details, see [Access permissions](#).

3 You can change the connection method at any time by clicking the down arrow again and choosing an alternative connection option.

4.4.2 To disconnect a console

1 Click the disconnect button in the lower left corner of the console entry that you wish to disconnect.

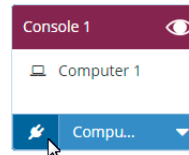

4.5 The Configure pages

The **Configure** menu option expands when clicked to reveal three sub-sections:

- Central Switch - settings related directly to the DCX3000 Switch.
- [Consoles](#) - settings related to the DCX3000 Remote modules and their connected peripherals.
- [Computers](#) - settings related to the DCX3000 SAM modules and their host computers.

4.5.1 Central Switch > General

Basic descriptive settings for the DCX3000 Switch. These are most useful when multiple DCX installations are being managed and labelling each installation as you go, is a good habit to get into:

- Name - displayed on the dashboard page of DCX Matrix to identify this switch.
- Description - a further opportunity to add more information about the switch.
- Location - a useful feature if you have multiple DCX3000 Switches distributed around.
- System Default EDID - determines the default EDID to use for the installation.
- Ignore Firmware Mismatch - when set to On, this overrides the checks that are made to ensure all modules are running compatible firmware versions. This override should be used in exceptional circumstances only.
- System Firmware Version - shows the version of the main system firmware.
- Switch Version - shows the version of the main system circuitry.
- Admin UI Version - shows the version of the DCX Matrix admin user interface.

The screenshot displays the 'Configure' interface for a Black Box DCX3000 switch. The left sidebar shows the navigation menu with 'CONFIGURE' selected, and 'CENTRAL SWITCH' highlighted. The main content area is titled 'Central Switch / General' and contains the following configuration fields:

Name	Black Box DCX3000
Description	Digital Matrix Switch
Location	Unspecified
System Default EDID	System - 1920x1080 @ 60Hz
Ignore Firmware Mismatch	<input checked="" type="checkbox"/> ON
System Firmware Version	0.01
Switch Version	0.01.3605
Admin UI Version	0.2.43

An orange 'Update' button is located at the bottom right of the configuration area. A callout box on the right side of the page points to the 'System Firmware Version', 'Switch Version', and 'Admin UI Version' fields, with the text: 'These items are shown only when the Maintenance > Settings > Web UI Mode is set to Advanced.'

4.5.2 Central Switch > Network

All of the key settings for the network capabilities of the DCX3000 Switch are here:

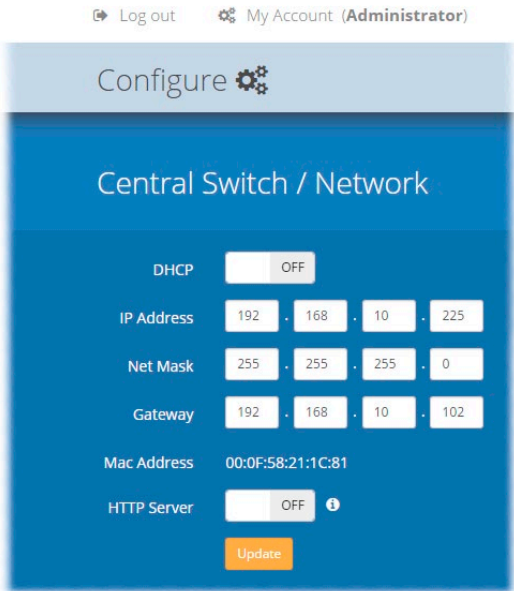

- DHCP - allows you to choose to use DHCP (Dynamic Host Configuration Protocol) to automatically determine all network settings or set them manually. When set to On, all other options in this page will be grayed out.
- IP Address - set the IP address for the switch.
- Net Mask - set a subnet mask to accompany the IP address.
- Gateway - optionally define a suitable address for a gateway device (only needed if external access to DCX Matrix is required).
- MAC Address - displays the unique (and fixed) MAC address for the switch.
- HTTP Server - switches to the use of insecure HTTP for web admin - switch reboot required. **IMPORTANT: Do not enable this option when the switch is connected to external networks.**

4.5.3 Central Switch > OSD Settings

Options related to the on screen display are presented in this section:

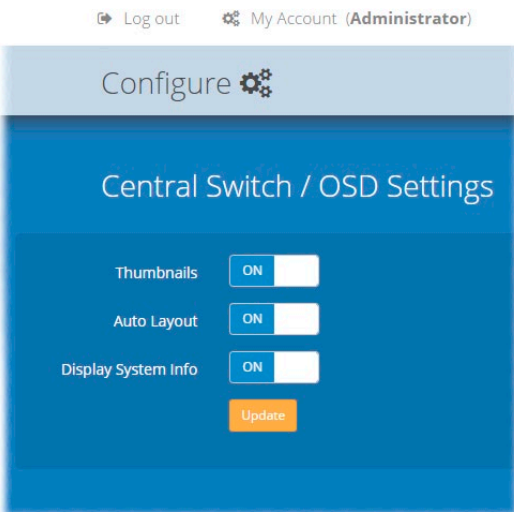

- Thumbnails - when set to Off, this option will hide the thumbnail views of each computer within each user's OSD main page.
- Auto Layout - when set to Off, this option will maintain a 5x5 grid for the displayed computers within the OSD main page, regardless of the number of available computers. When set to On, the OSD view grid will be re-scaled accordingly.
- Display System Info - when set to On, details will be shown against each computer within the OSD view grid.

4.5.4 Central Switch > Manage EDIDs

This page lists the EDID (Extended Display Identification Data) profiles that are currently available:

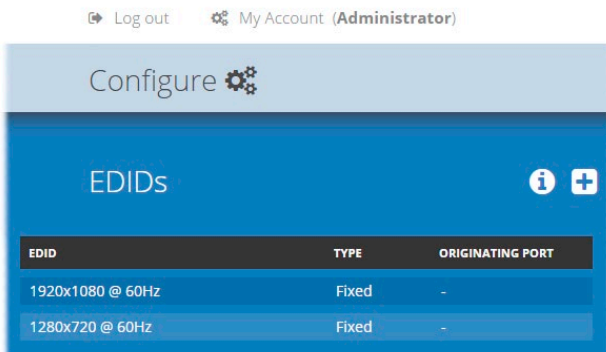

Log out My Account (Administrator)

Configure

EDIDs

EDID	TYPE	ORIGINATING PORT
1920x1080 @ 60Hz	Fixed	-
1280x720 @ 60Hz	Fixed	-

- EDID - shows the resolutions and refresh rates for all EDID profiles that are currently stored.
- Type - indicates where each EDID profile originated: Fixed EDIDs are included within the switch firmware and cannot be removed. User EDIDs are those that have been cloned from particular video displays attached to DCX3000 Remote modules - these can be deleted if required. On the main [Central Switch/General](#) page you can select the 'Default System EDID' from the list of fixed and user EDIDs.
- Originating Port - indicates which switch port supplied each user EDID.

Note: The DCX3000 Switch will modify the EDID, if a Dual link monitor is connected, to list only the video resolutions that it is capable of supporting.

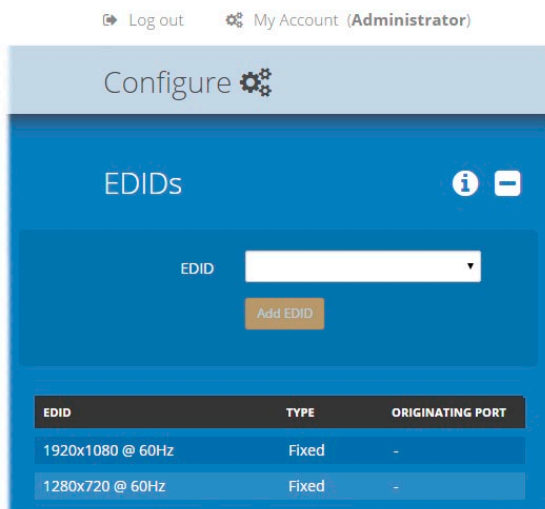

Log out My Account (Administrator)

Configure

EDIDs

EDID

Add EDID

EDID	TYPE	ORIGINATING PORT
1920x1080 @ 60Hz	Fixed	-
1280x720 @ 60Hz	Fixed	-

4.5.4.1 Add EDID

If additional EDID definitions are required for your installation, you can clone new definitions from connected video displays and add these to the list of available definitions.

Click the [+] icon to begin collecting a new EDID from a display attached (via a DCX3000 Remote module) to one of the switch ports.

Click the EDID dropdown list and choose the appropriate receiver (DCX3000 Remote module) from which you wish to clone a new EDID profile. Then click the Add EDID button.

For details about applying an EDID to a particular computer, see [Configure > Computers > Transmitters](#).

4.6 Configure > Consoles

A Console is a collective term for a set of peripheral devices arranged around one or more DCX3000 Remote modules. This page lists all registered consoles alphabetically by their Names:

NAME	DESCRIPTION	PORTS	CONNECTED COMPUTER	CURRENT ACCESS MODE	CURRENT USER
Console 1	Console on Port 21	[21]	Computer 1	VIEWONLY	-
Console 10	Console on Port 30	[30]	Computer 1	EXCLUSIVE	-
Console 2	Console on Port 22	[22]	-	-	-
Console 3	Console on Port 23	[23]	-	-	-
Console 4	Console on Port 24	[24]	-	-	-
Console 5	Console on Port 25	[25]	-	-	-
Console	Console on Port 26	[26]	-	-	-

Add new
Click to add a new console. See opposite.

Edit
Click an entry to view/edit its details and access permissions. See opposite.



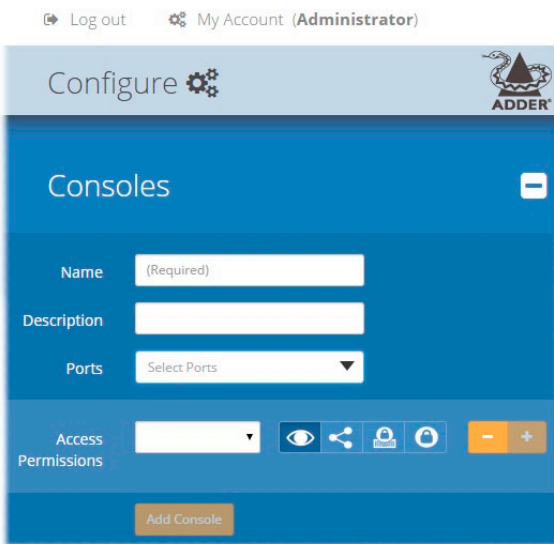

In addition to the Name and Description, the columns also provide the following useful details for each console entry:

- Ports - each DCX3000 Remote module connects to a single port on the DCX3000 Switch. This column lists the port(s) used by the DCX3000 Remote module(s) associated with the console. Two or more DCX3000 Remote modules can be combined to form multi-head consoles, each connecting to a separate port.
Note: For consoles with multiple displays (multi-head), additional user console ports are required. If there are no spare user console ports available then any unused computer ports on the rear panel can be deleted in order to free them up as spares. See [Reallocating ports](#).
- Connected Computer - shows to which computer the console is currently connected.
- Current Access Mode - indicates how the console is permitted to access computers, e.g. View only, Shared, Exclusive, etc.
- Current User - lists the user, if any, that is currently logged into the console.



4.6.1 Add new





Click the [+] icon to begin adding a new console, either before or after connecting the DCX3000 Remote module(s):

- Name - the main identifier for the new console.
- Description - a further opportunity to add more information about the console.
- Ports - add the user port number (located on the main switch) used by the DCX3000 Remote module associated with this console. For multi-head consoles, ensure that the port used by the primary DCX3000 Remote module (the one that has the primary display and peripherals attached) is the first one in the list. If you require more than the usual 10 console ports, see [Reallocating ports](#).
- Access Permissions - click the [+] button to select one or more computers that this console will be permitted to access. For each computer choose one of the four icons to set the access method:
 -  View only,
 -  Shared access,
 -  Exclusive, or
 -  Private modes.



4.6.2 Configure > Consoles > Edit an entry

Click on an entry within the Configure > Consoles list to display this page. Here you can edit the configuration details for a chosen console.

- Name - the main identifier for the console.
- Description - a further opportunity to add more information about the console.
- Ports - shows the user port number(s) (located on the main switch) used by the DCX3000 Remote module(s) associated with this console. For multi-head consoles, ensure that the port used by the primary DCX3000 Remote module (the one that has the primary display and peripherals attached) is the first one in the list. If you require more than the usual 10 console ports, see [Reallocating ports](#).
- Access Permissions - choose which computers this console is permitted to access. For each computer choose one of the four icons to set the access method:
 -  View only - console user can view a computer's output but not alter it,
 -  Shared access - console user can view and control a computer along with other consoles,
 -  Exclusive - multiple console users can view a computer but only one can control it, or
 -  Private - console user can view and control the computer privately while other users are locked out.

For further details, see [Access permissions](#).

When you have made your changes, click the Update button.

4.7 Configure > Consoles > Receivers

At the heart of each console (the collective term for a set of peripherals connected to the DCX system) is a receiver called a DCX3000 Remote module.

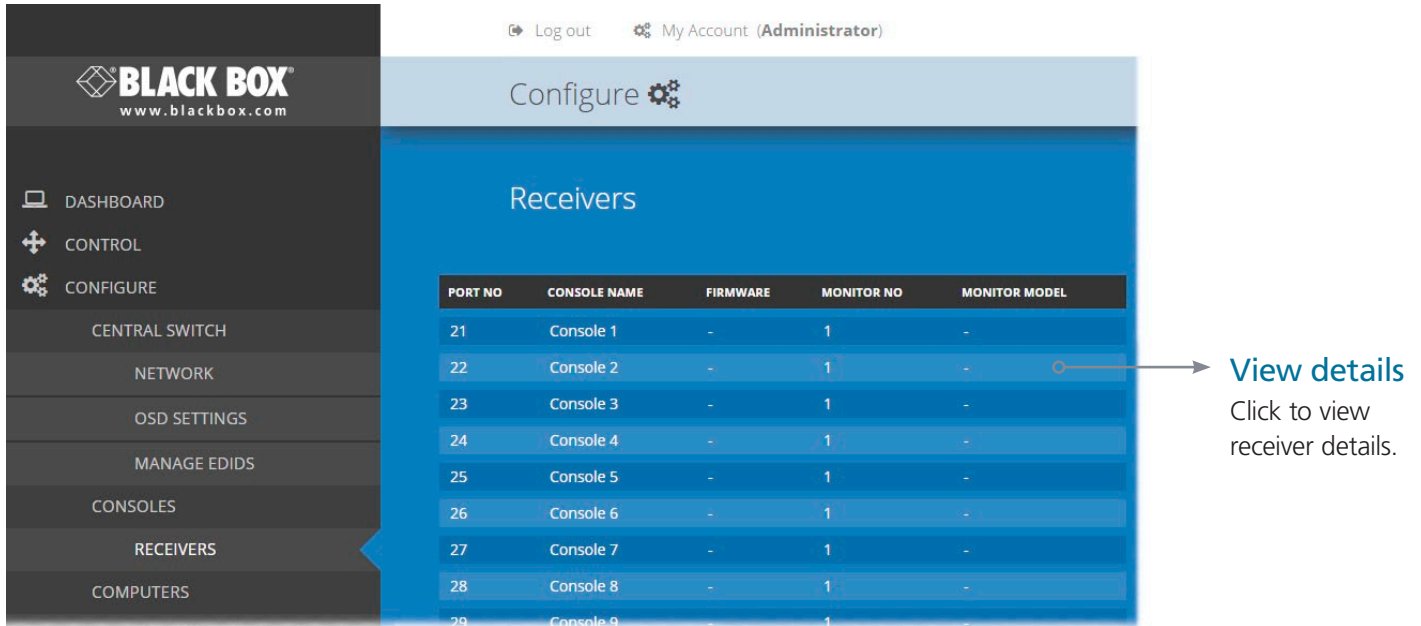

Listed in order of the DCX3000 Switch port to which they are attached, this page shows various details for each DCX3000 Remote module:

- Firmware - the current internal software version for each DCX3000 Remote module.
- Monitor No - an index number for each video display. The first monitor for any console will be indexed as '1'. Where a console has more than one video display associated with it (by using additional DCX3000 Remote modules), this column will show '2', '3', etc. against the secondary, tertiary, etc. DCX3000 Remote module(s).
- Monitor model - indicates the video display model as reported to the DCX3000 Remote module to which it is connected.
- USB Enabled - indicates the USB status of the DCX3000 Remote module. Where modules are employed to provide additional video monitor outputs, the USB connections are usually disabled.
- Unique ID - (shown only when the Maintenance > Settings > Web UI Mode is set to Advanced) this column displays the unique identifier hardwired into every DCX3000 Remote module.

The screenshot displays the Black Box configuration web interface. At the top, there are links for 'Log out' and 'My Account (Administrator)', along with a version indicator 'v 0.0'. The main header includes 'Configure' with a gear icon and the 'BLACK BOX' logo. The breadcrumb navigation shows 'Receivers / Console 1 / Port 21'. Below this, a table lists receiver specifications:

Firmware	0.01.3575
Unique ID	1C500109A69C3EAE85F81D54461900F5
Monitor No	1
Monitor Model	KVM-via-IP
Monitor Serial No	
Monitor Resolution	1280 x 1024 @ 60 Hz

At the bottom, the 'Receiver Operations' section contains two buttons: 'Reboot Receiver' (with a circular arrow icon) and 'Recover Receiver' (with a wrench icon).

4.7.1 View receiver details

Click a receiver entry to view the configuration details of the DCX3000 Switch port to which it is connected.

Within this page it is possible to reboot and/or recover a receiver.

4.7.1.1 Recovering a receiver

This option (shown only when the Maintenance > Settings > Web UI Mode is set to Advanced) is used to reprogram a receiver that has failed during a firmware upgrade. Once the Recover Receiver button is clicked, you will be asked to power cycle the respective receiver, whereupon it will boot up into recovery mode. Then you will be asked to click a Reprogram button to commence the operation.

4.8 Configure > Computers

This page lists the computer systems that are connected to the DCX3000 Switch unit via individual DCX3000 SAM modules:

Log out My Account (Administrator)

BLACK BOX
www.blackbox.com

Configure

Computers

NAME	DESCRIPTION	PORTS	THUMBNAIL	PRIMARY CONSOLE	CONNECTED CONSOLES	CURRENT ACCESS MODE
Computer 1	Computer on Port 1	[1]	TRUE	Console 10	Console 1, Console 10	EXCLUSIVE
Computer 10	Computer on Port 10	[10]	TRUE	-	-	-
Computer 11	Computer on Port 11	[11]	TRUE	-	-	-
Computer 12	Computer on Port 12	[12]	TRUE	-	-	-
Computer 13	Computer on Port 13	[13]	TRUE	-	-	-
Computer 14	Computer on Port 14	[14]	TRUE	-	-	-

Add new
Click to add a new computer. See opposite.

Edit
Click an entry to view/edit its details and options. See opposite.

In addition to the Name and Description, the columns also provide the following useful details for each computer entry:

- **Ports** - each DCX3000 SAM module connects to a single port on the DCX3000 Switch. This column lists the port(s) used by the DCX3000 SAM module(s) associated with each computer. Two or more DCX3000 SAM modules can be combined to support extra displays (multi-head), each connecting to a separate port. It may be necessary to delete existing (but unused) computer/port associations in order to free up ports for the additional module(s). Additionally, three of the user console ports (21 to 23) can be changed into computer ports, if there are fewer user consoles within your installation. See [Reallocating ports](#)
- **Thumbnail** - indicates whether a thumbnail image of the computer's video output will be shown on the OSD screen for each user. If set to False, a black image will be shown in the OSD screen.
- **Primary Console** - indicates the console that currently has control of the computer.
- **Connected Consoles** - lists all consoles to which each computer is attached.
- **Current Access Mode** - indicates how the console is permitted to access computers, e.g. View only, Shared, Exclusive, or Private.

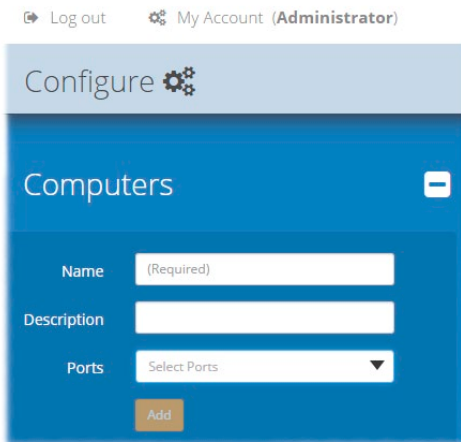

4.8.1 Add new

Click the [+] icon to begin adding a new computer, either before or after connecting the DCX3000 SAM module(s):

- Name - the main identifier for the new computer.
- Description - a further opportunity to add more information about the computer.
- Ports - Add one or more port numbers used by the DCX3000 SAM module(s) associated with this computer.

4.8.2 Configure > Computers > Edit an entry

This page allows you to edit the configuration details for a chosen computer.

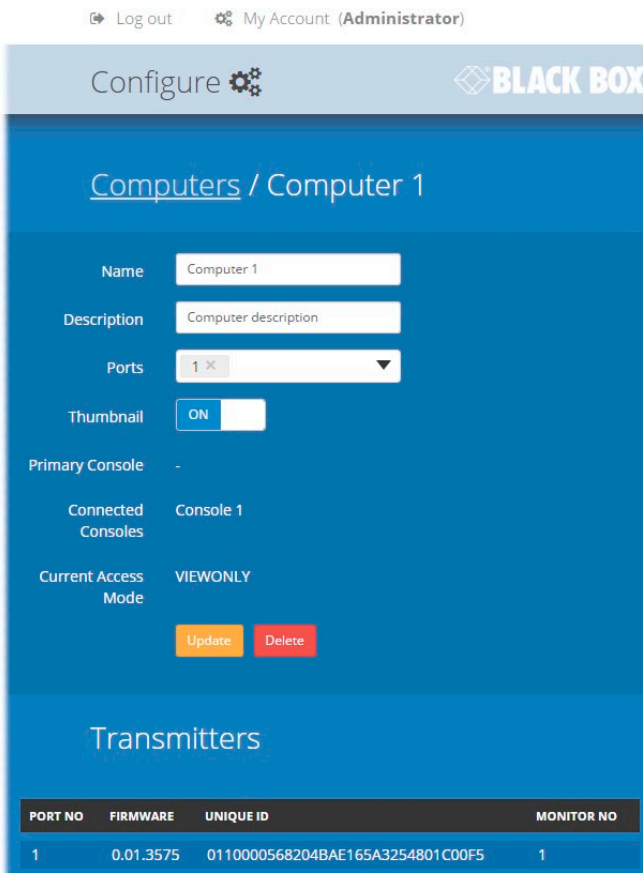

- Name - the main identifier for the computer.
- Description - a further opportunity to add more information about the computer.
- Ports - shows the one or more port numbers used by the DCX3000 SAM module(s) associated with this computer. For multi-head computers, ensure that the port used by the primary DCX3000 SAM module (the one linked to the primary video output) is the first one in the list. It may be necessary to delete existing (but unused) computer/port associations in order to free up ports for the additional module(s). Additionally, three of the user console ports (21 to 23) can be changed into computer ports, if there are fewer user consoles within your installation. See [Reallocating ports](#)
- Primary Console - indicates the primary console that is connected to this computer.
- Connected Consoles - indicates other consoles that are also connected to this computer.
- Current Access Mode - indicates the access mode (e.g. View Only, Shared, Exclusive, etc.) that is currently being used for this computer.
- Transmitters - lists the transmitters (DCX3000 SAM modules) that are serving this computer.

When you have made your changes, click the Update button.

4.9 Configure > Computers > Transmitters

Each computer connects to a DCX3000 SAM transmitter module. This page lists each DCX3000 SAM module and their key details:

The screenshot shows the Black Box web interface. The top navigation bar includes 'Log out' and 'My Account (Administrator)'. The main content area is titled 'Configure' and 'Transmitters'. A table lists the following data:

PORT NO	COMPUTER NAME	FIRMWARE	MONITOR NO
1	Computer 1	-	1
2	Computer 2	-	1
3	Computer 3	-	1
4	Computer 4	-	1
5	Computer 5	-	1
6	Computer 6	-	1
7	Computer 7	-	1
8	Computer 8	-	1
9	Computer 9	-	1
10	Computer 10	-	1

An arrow points from the 'View details' link to the second row of the table. Below the link, it says 'See opposite.'

Listed in order of the DCX3000 Switch port to which they are attached, this page shows various details for each DCX3000 SAM module:

- Computer Name - the given name for each connected computer.
- Firmware - the current internal software version for each DCX3000 SAM module.
- Monitor No - an index number for each video display port. The first port for any computer will be indexed as '1'. Where a computer has more than one video display connected it (by using additional DCX3000 SAM modules), this column will show '2', '3', etc. against the secondary, tertiary, etc. DCX3000 SAM module(s).
- Unique ID - (shown only when the Maintenance > Settings > Web UI Mode is set to Advanced) this column displays the unique identifier hardwired into every DCX3000 SAM module.

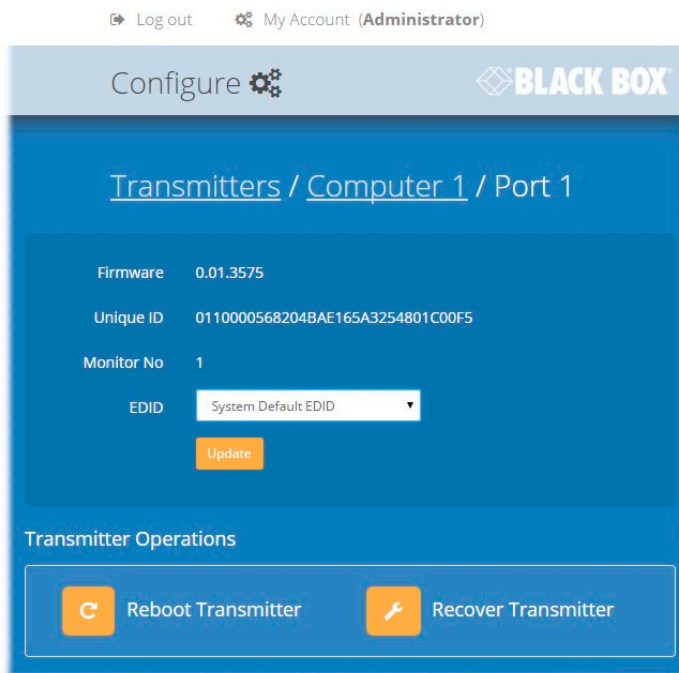

4.9.1 View transmitter details

Click a transmitter entry to view the configuration details of the DCX3000 Switch port to which it is connected.

Within this page it is possible to reboot and/or recover a transmitter.

4.9.1.1 Applying a different EDID

If a computer needs to use an EDID profile that differs from the one being used as the default System EDID, use these steps:

- 1 If necessary, clone the required EDID - see [Add EDID](#).
- 2 View the Configure > Computers > Transmitters page and click on the required computer entry (to show the page above).
- 3 Change the Use System EDID option to Off.
- 4 Select your cloned EDID using the EDID drop down list.
- 5 Click the Update button.

4.9.1.2 Recovering a transmitter

This option (shown only when the Maintenance > Settings > Web UI Mode is set to Advanced) is used to reprogram a transmitter that has failed during a firmware upgrade. Once the Recover Transmitter button is clicked, you will be asked to power cycle the respective transmitter, whereupon it will boot up into recovery mode. Then you will be asked to click a Reprogram button to commence the operation.

4.10 Reallocating ports

By default the DCX3000 Switch provides 20 computer ports along its rear panel and 10 user console ports along its front panel. If your installation has a greater number of computers or a need for more user consoles, you can alter the allocation of these standard ports:

- Any of the 20 rear panel computer ports can be reallocated as user console ports, or
- Three of the front panel ports (labeled 21 to 23) can be used as computer ports.

When reallocating a port, it is usually necessary to delete it from its default role before using it in its new mode, as follows:

4.10.1 To reallocate a computer port as a user console port

- 1 Access the Configure > Computers page.
- 2 Click the entry for the computer port you wish to change.
- 3 Click the Delete button and then confirm your action in the resulting popup.
- 4 Access the Configure > Consoles page.
- 5 Either:
 - Click the [+] button to create a new console entry, or
 - Click an existing console entry to add the new port to it.
- 6 Click the Ports down arrow to view the available ports and choose the number of the port that you previously made available.
- 7 Add/edit any other details for the console entry and click either the Add Console button or Update button, as appropriate.

4.10.2 To reallocate a user console port as a computer port

- 1 Access the Configure > Consoles page.
- 2 Click the entry for the user console port you wish to change.
- 3 Click the Delete button and then confirm your action in the resulting popup.
- 4 Access the Configure > Computers page.
- 5 Either:
 - Click the [+] button to create a new computer entry, or
 - Click an existing computer entry to add the new port to it.
- 6 Click the Ports down arrow to view the available ports and choose the number of the port that you previously made available.
- 7 Add/edit any other details for the computer entry and click either the Add button or Update button, as appropriate.

4.11 The Users page

This page lists all registered users and allows the admin user to add, edit and delete entries, as required.

Note: When changes are made to user details, you are recommended to make a backup file.

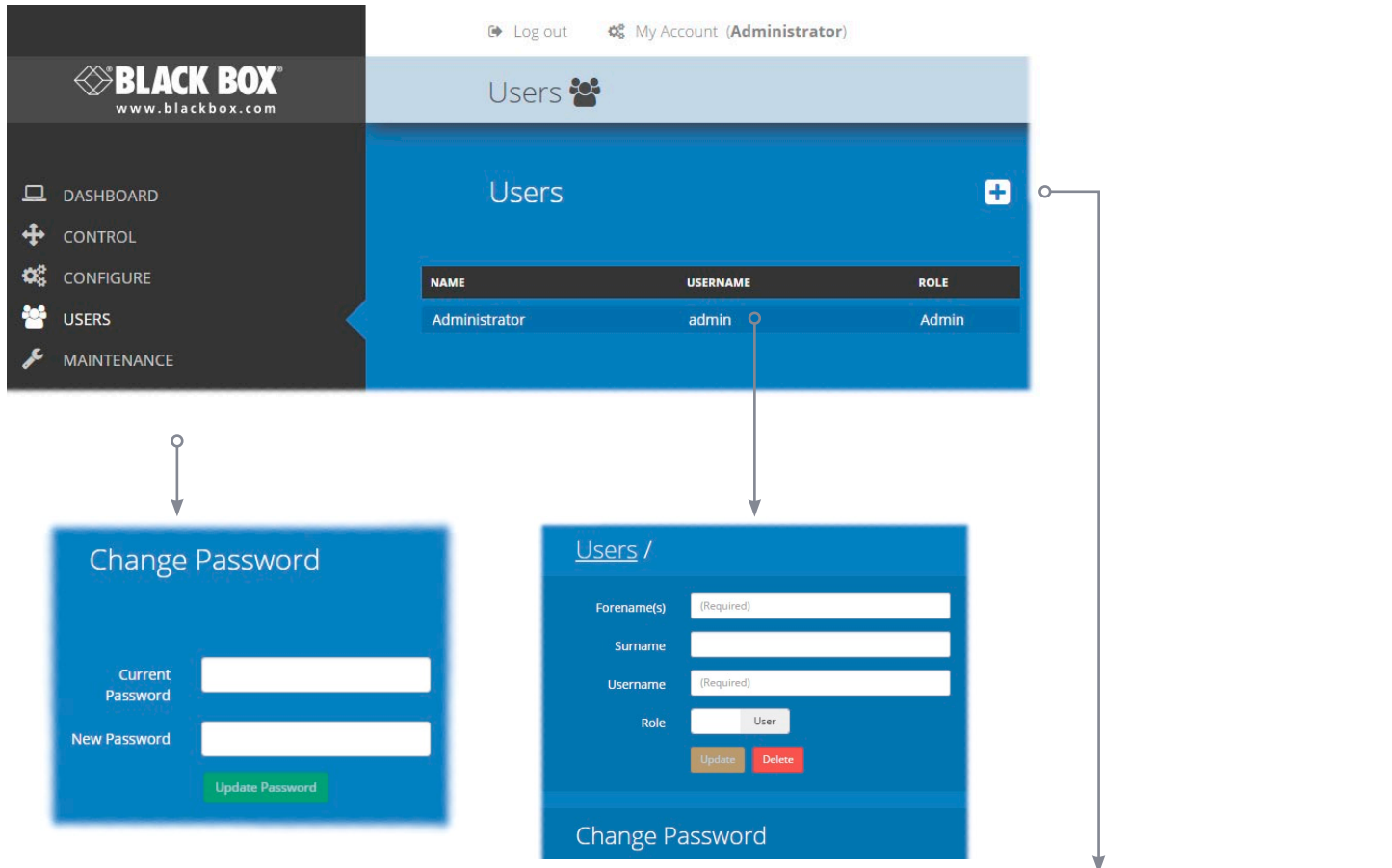

Change password

Click to change the password for the user/admin currently logged into DCX Matrix.

Edit

Click a user entry to edit its details.

Add new

Click the [+] icon to begin adding a new user.

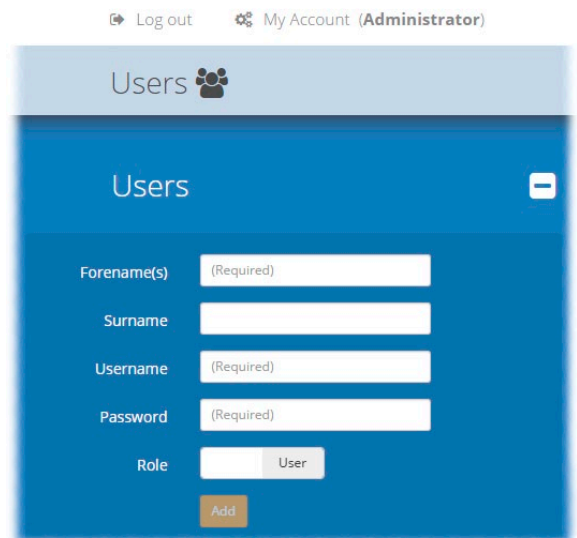

4.12 The Maintenance pages

The Maintenance section contains three pages: Diagnostics, System Operations and Settings.

4.12.1 Maintenance > Diagnostics

This page provides important feedback on power inputs (and switch Temperatures). The temperature information is displayed only when the Maintenance > Settings > Web UI Mode is set to Advanced.

Log out My Account (Administrator)

Maintenance

Diagnostics

Supply	
Supply A	Supply OK
Supply B	Supply OK

Temperature	
CPU core	62 ° C
Case	26 ° C
Board	44 ° C
X-Point (Red)	38 ° C
X-Point (Blue)	31 ° C
X-Point (Green)	35 ° C

This section indicates the status of the mains power input(s).

These items are only shown when Settings > Advanced Mode On is chosen. This section indicates the current temperature readings within the DCX3000 Switch for the following:

- The processor core,
- The internal case area,
- The main circuit board,
- The red, green and blue video switches.

4.12.2 Maintenance > System Operations

This page provides a selection of important system operations that may be required at various times.

The screenshot shows the Black Box web interface. At the top right, there are links for 'Log out' and 'My Account (Administrator)'. The main header is 'Maintenance' with a wrench icon. The left sidebar contains a navigation menu with the following items: DASHBOARD, CONTROL, CONFIGURE, USERS, MAINTENANCE (highlighted), DIAGNOSTICS, SYSTEM OPERATIONS, and SETTINGS. The main content area is titled 'System Operations' and displays the current 'System Firmware Version: 0.01'. Below this, there are five action cards:

- Upgrade Firmware:** Upgrade the Switch and connected Transmitters / Receivers with newer firmware from a file.
- Sync Tx / Rx Firmware:** Upgrade connected Transmitters / Receivers if different to Switch firmware version. Includes a link 'Show devices to be updated'.
- Reboot System:** Reboot the Switch and all connected Transmitters / Receivers.
- Backup:** Backup system configuration to file.
- Restore:** Restore system configuration from backup file.

Upgrade Firmware

Upgrades the firmwares of all of the DCX3000 Switch and all connected modules to the latest version. Confirmation is required once this button is clicked.

Sync Tx/Rx Firmware

Upgrades the firmwares of all connected modules to match that of the main switch. Confirmation is required once this button is clicked.

Note: Be sure that the DCX3000 Switch has the latest firmware installed before using this option.

Reboot System

Performs a complete reboot of the entire DCX system, including the switch and all modules. Confirmation is required once this button is clicked.

Backup

Saves a copy of the DCX Matrix system configuration to a file. Backup files are stored on the computer viewing DCX Matrix.

Restore

Restores the DCX Matrix system configuration from a backup file. A file dialog will be displayed to allow you to choose the filename and location.

4.12.3 Maintenance > Settings

This page provides options related to the user interface. When you make a change, you need to click the Update button to save it.

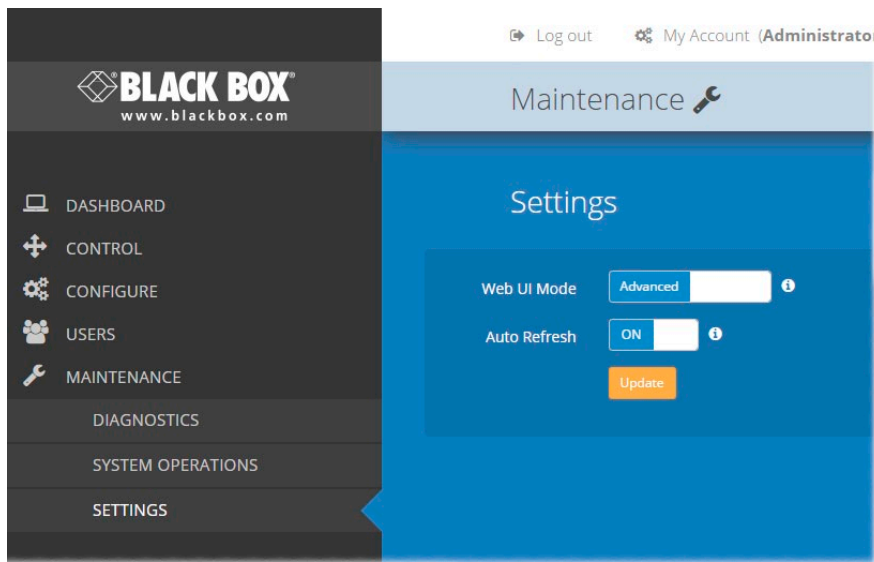

Web UI Mode

When this option is set to Advanced, extra details are shown on certain pages, such as:

- Configure > Central Switch > General
- Configure > Consoles > Receivers
- Configure > Computers > Transmitters
- Maintenance > Diagnostics

Auto Refresh

When this option is set to On, the Dashboard, Control and Diagnostic pages will automatically update their contents every few seconds.

Update

Click this button to save and enact any changes made to options.

4.13 Resetting and recovering

There may be rare occasions when the main switch or a module needs to be given a hard reset. The DCX3000 Switch and DCX3000 Remote module both have concealed reset buttons for this purpose. You need to use a narrow implement (e.g. a straightened-out paper clip) to press-and-hold the recessed reset button on the front panel:

4.13.1 DCX3000 Switch

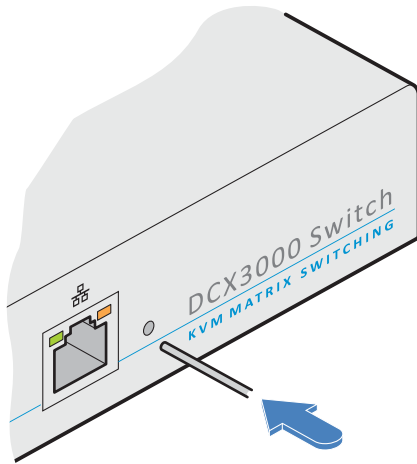

4.13.1.1 DCX3000 Switch > Boot into recovery image

This procedure may be necessary if an attempted firmware upgrade has failed. For such a situation the DCX3000 Switch always retains a recovery image that will return the unit to a working condition, prior to reattempting a firmware upgrade. Note: All configuration data (e.g. users, consoles, computers, networking, etc.) will be retained.

- 1 Press-and-hold the recessed reset button for ten seconds until the STS (Status) indicator begins to flash slowly.
- 2 Release the reset button. The STS indicator will go out and the switch will boot itself using the recovery image. The STS indicator will now begin to flash again to indicate that it is running from the recovery image (a red banner will also be shown at the top of the DCX Matrix screen).
- 3 When you are sure of operating conditions, such as having good power stability, proceed once again with the firmware upgrade.

4.13.1.2 DCX3000 Switch > Full factory reset

This procedure can be used when you wish to clear all data, restore the primary firmware image and return the DCX3000 Switch to a known state. Note: All configuration data (e.g. users, consoles, computers, networking, etc.) will be deleted.

- 1 Press-and-hold the recessed reset button for twenty seconds (after ten seconds, the STS indicator will flash as described above) and then after twenty seconds it will begin to flash at a quicker rate.
- 2 Release the reset button. The STS indicator will go out while the switch performs the reset and will then illuminate again to indicate that the factory reset is complete.

4.13.2 DCX3000 Remote module

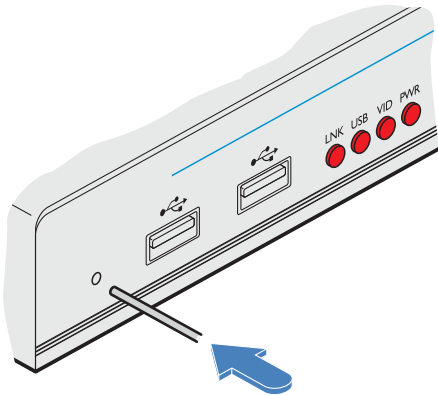

4.13.2.1 DCX3000 Remote module > Boot into recovery mode

This procedure may be necessary if an attempted firmware upgrade has failed. For such a situation the DCX3000 Remote module always retains a recovery image that will return the unit to a working condition, prior to reattempting a firmware upgrade.

- 1 Press-and-hold the recessed reset button for ten seconds until the PWR indicator begins to flash quickly.
- 2 Release the reset button.
- 3 When you are sure of operating conditions, such as having good power stability, proceed once again with the firmware upgrade.

4.13.2.2 DCX3000 Remote module > Reset

This procedure may be necessary if a DCX3000 Remote has become unresponsive.

- 1 Press-and-release the recessed reset button. The DCX3000 Remote module will reboot.

5. Operation

The DCX system is designed to be transparent in operation. A simple OSD (On Screen Display) interface allows each user to view and select from the available host computers.

5.1 Viewing the OSD

5.1.1 To view the matrix

1 From a console keyboard, press CTRL + ALT + M to display the matrix:

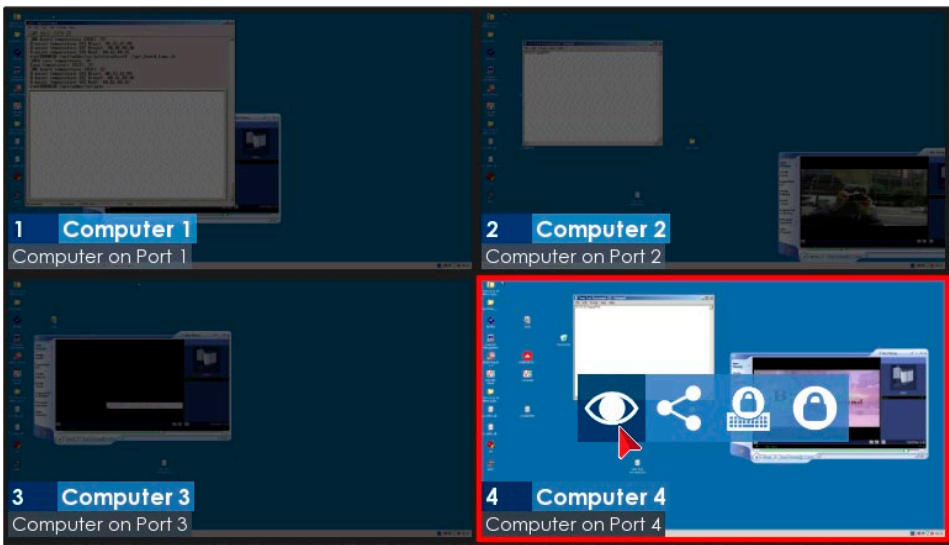





The outputs of the available host computers will be displayed within live thumbnail images.

Note: If video is not available for a computer, or the thumbnail feature has been disabled by the admin user, a black image will be shown.

5.2 Choosing a computer

5.2.1 To choose a computer using the mouse

1 Hover the mouse pointer over the required screen image. A set of popup connection icons will be displayed:

-  View only - you can view a computer's output but not alter it,
-  Shared access - you can view and control a computer along with other consoles,
-  Exclusive - multiple users can view a computer but only one (the first to make connection) can control it,
or
-  Private - you can view and control the computer privately while other users are locked out.

For more details, see [Access permissions](#).

Note: If an icon is grayed out, that access method is not available.

2 Click the required connection method. The video output from the chosen computer will be displayed full screen and you can use it as normal.

5.2.2 To choose a computer using hotkeys

- Press and hold Ctrl + Alt and type the number of the required computer. The video output from the chosen computer will be displayed full screen and you can use it as normal.

Note: Shared mode is always used when access is made via hotkeys.

5.3 Indicators

The DCX3000 Switches, the DCX3000 SAM and DCX3000 Remote modules contain various indicators to provide you with status information.

5.3.1 DCX3000 Switch - Red front panel status indicators

The red status indicators on DCX3000 Switch front panels provide various key power and operation feedback:

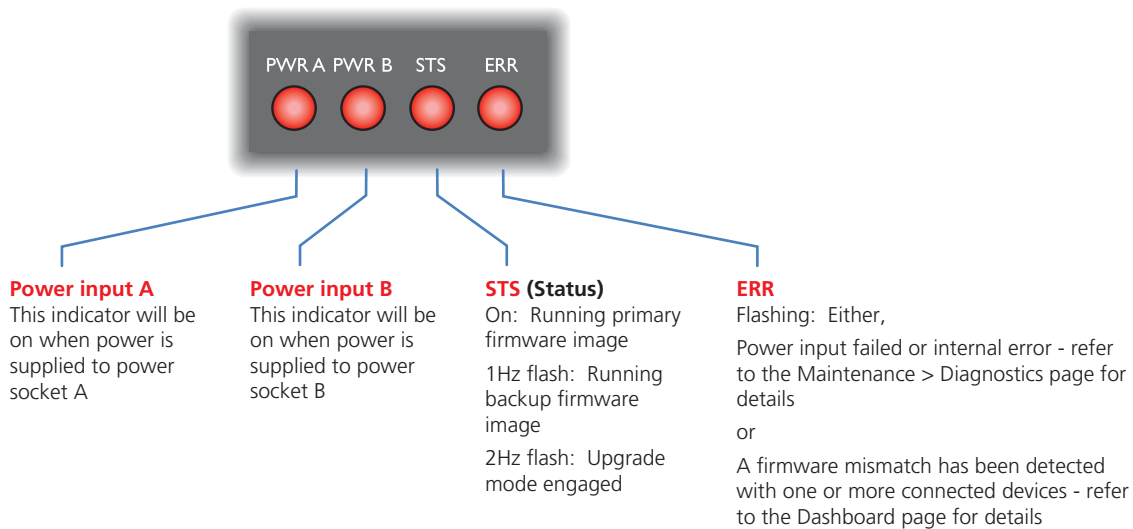

5.3.2 DCX3000 Switch - Green and amber network status indicators

The green and amber status indicators on the network link port provide further status information:

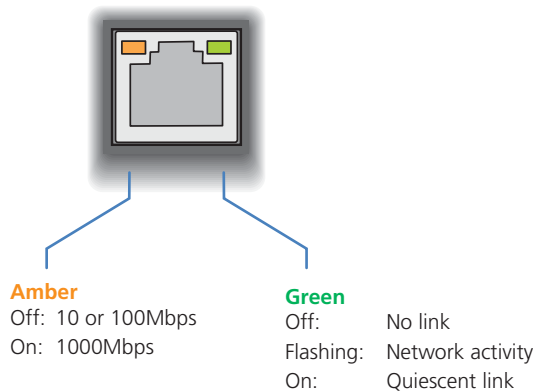

5.3.3 DCX3000 Remote module - Green and amber status indicators

The green and amber indicators on the link port of each DCX3000 Remote module provide the following status information:

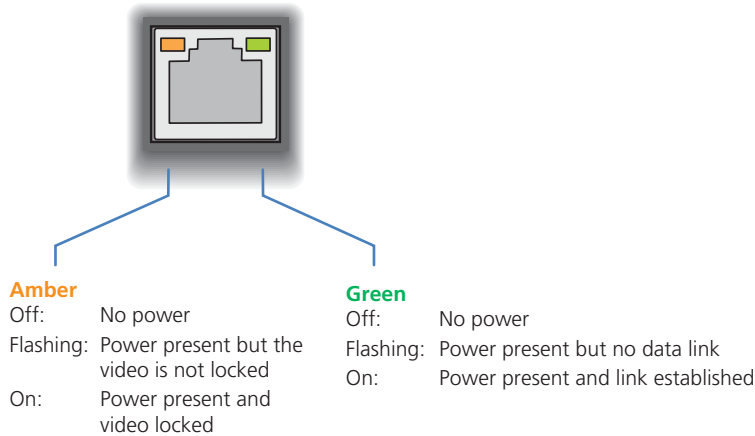

5.3.4 DCX3000 Remote module - Red front panel status indicators

The red indicators on the front panel of each DCX3000 Remote module provide the following status information:

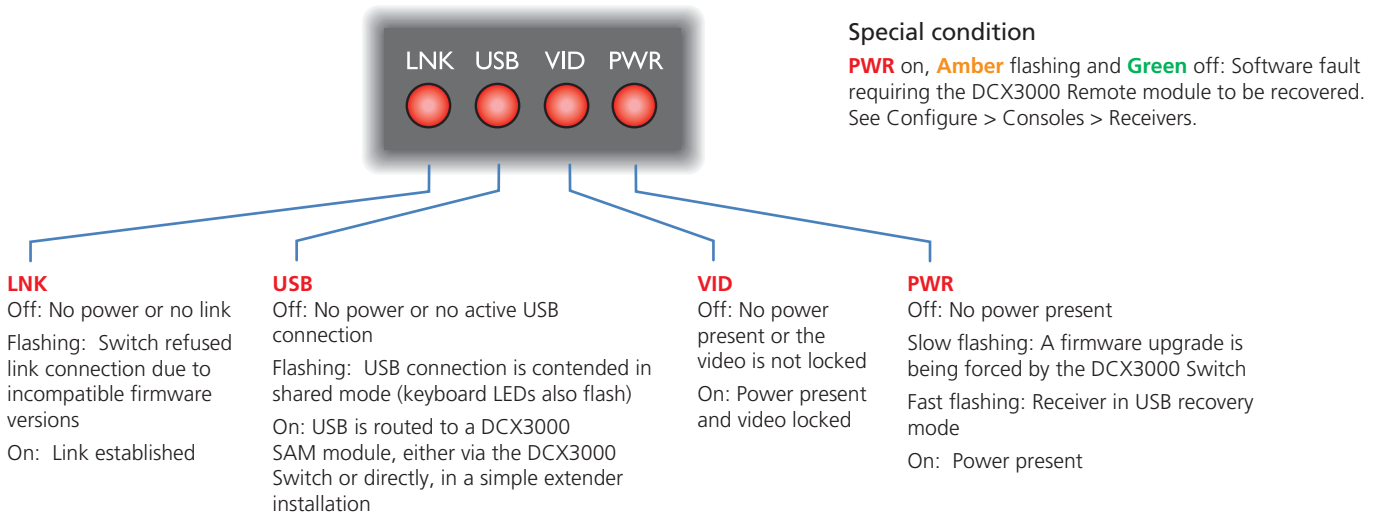

5.3.5 DCX3000 SAM module - Green and amber status indicators

The green and amber indicators on the link port of each DCX3000 SAM (computer) module provide the following status information:

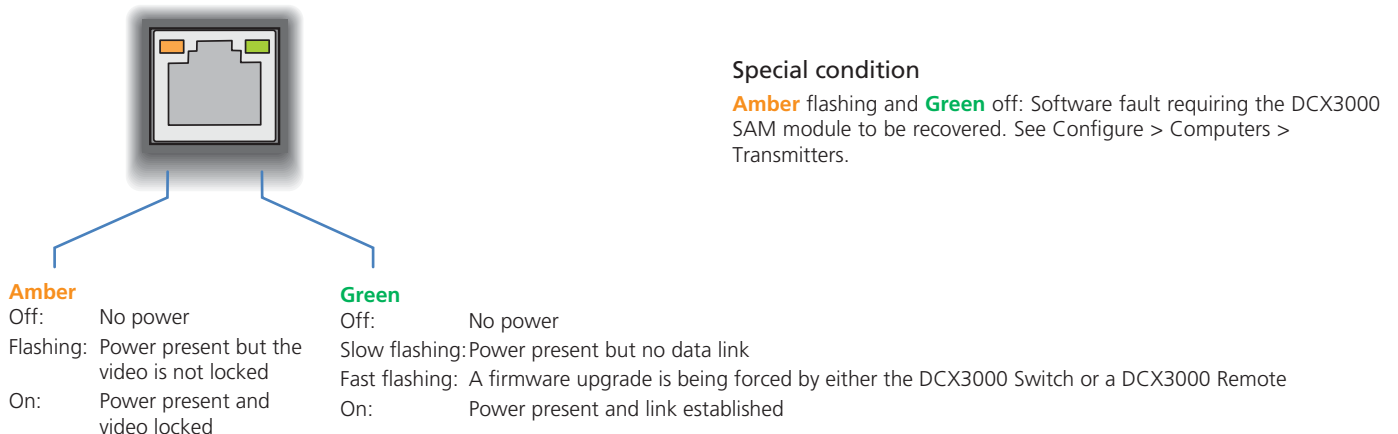

Appendix A. Safety Information

- For use in dry, oil free indoor environments only.
- Do not use to link between buildings.
- Ensure that the twisted pair interconnect cable is installed in compliance with all applicable wiring regulations.
- Do not connect the CATx link interface (RJ45 style connector) to any other equipment, particularly network or telecommunications equipment.
- Warning – the power adapter contains live parts.
- No user serviceable parts are contained within the power adapter - do not dismantle.
- Plug the power adapter into a grounded socket outlet close to the unit that it is powering.
- Replace the power adapter with a manufacturer approved type only.
- Do not use the power adapter if the power adapter case becomes damaged, cracked or broken or if you suspect that it is not operating properly.
- If you use a power extension cord with the units, make sure the total ampere rating of the devices plugged into the extension cord do not exceed the cord's ampere rating. Also, make sure that the total ampere rating of all the devices plugged into the wall outlet does not exceed the wall outlet's ampere rating.
- Do not attempt to service the units yourself.
- The units and power supplies can get warm in operation – do not situate them in an enclosed space without any ventilation.
- The units do not provide ground isolation and should not be used for any applications that require ground isolation or galvanic isolation.

Black Box Tech Support: FREE! Live. 24/7.

Tech support the
way it should be.



Great tech support is just 60 seconds away at 724-746-5500 or blackbox.com.



About Black Box

Black Box Network Services is your source for an extensive range of networking and infrastructure products. You'll find everything from cabinets and racks and power and surge protection products to media converters and Ethernet switches all supported by free, live 24/7 Tech support available in 60 seconds or less.

© Copyright 2015. Black Box Corporation. All rights reserved.

DCX3000, rev. 1.0