



ACX048  
ACX080  
ACX160  
ACX288

ACX108-C  
ACX108-SM  
ACX108-SPF

ACX288-CTL  
ACXSFP  
ACXSFP5

ACX080-PS  
ACX160-PS  
ACX288-PS

## ServSwitch™ DKM FX

Provides flexible and super-fast crosspoint switching of Full HD video in KVM enterprises.



Customer  
Support  
Information

Order toll-free in the U.S.: Call 877-877-BBOX (outside U.S. call 724-746-5500)  
FREE technical support 24 hours a day, 7 days a week: Call 724-746-5500 or fax  
724-746-0746 • Mailing address: Black Box Corporation, 1000 Park Drive, Lawrence,  
PA 15055-1018 • Web site: [www.blackbox.com](http://www.blackbox.com) • E-mail: [info@blackbox.com](mailto:info@blackbox.com)

## Trademarks Used in this Manual

---

### Trademarks Used in this Manual

Black Box and the Double Diamond logo are registered trademarks, and ServSwitch is a trademark, of BB Technologies, Inc.

Mac is a registered trademark of Apple Computer, Inc.

IBM is a registered trademark of International Business Machines Corporation.

Java is a registered trademark of Oracle Corporation.

TOSLINK is a registered trademark of Toshiba Corporation.

Any other trademarks mentioned in this manual are acknowledged to be the property of the trademark owners.

### FEDERAL COMMUNICATIONS COMMISSION AND INDUSTRY CANADA RADIO FREQUENCY INTERFERENCE STATEMENTS

This equipment generates, uses, and can radiate radio-frequency energy, and if not installed and used properly, that is, in strict accordance with the manufacturer's instructions, may cause interference to radio communication. It has been tested and found to comply with the limits for a Class A computing device in accordance with the specifications in Subpart B of Part 15 of FCC rules, which are designed to provide reasonable protection against such interference when the equipment is operated in a commercial environment. Operation of this equipment in a residential area is likely to cause interference, in which case the user at his own expense will be required to take whatever measures may be necessary to correct the interference.

Changes or modifications not expressly approved by the party responsible for compliance could void the user's authority to operate the equipment.

This digital apparatus does not exceed the Class A limits for radio noise emission from digital apparatus set out in the Radio Interference Regulation of Industry Canada.

Le présent appareil numérique n'émet pas de bruits radioélectriques dépassant les limites applicables aux appareils numériques de la classe A prescrites dans le Règlement sur le brouillage radioélectrique publié par Industrie Canada.

### Normas Oficiales Mexicanas (NOM) Electrical Safety Statement INSTRUCCIONES DE SEGURIDAD

1. Todas las instrucciones de seguridad y operación deberán ser leídas antes de que el aparato eléctrico sea operado.
2. Las instrucciones de seguridad y operación deberán ser guardadas para referencia futura.
3. Todas las advertencias en el aparato eléctrico y en sus instrucciones de operación deben ser respetadas.

4. Todas las instrucciones de operación y uso deben ser seguidas.
5. El aparato eléctrico no deberá ser usado cerca del agua—por ejemplo, cerca de la tina de baño, lavabo, sótano mojado o cerca de una alberca, etc.
6. El aparato eléctrico debe ser usado únicamente con carritos o pedestales que sean recomendados por el fabricante.
7. El aparato eléctrico debe ser montado a la pared o al techo sólo como sea recomendado por el fabricante.
8. Servicio—El usuario no debe intentar dar servicio al equipo eléctrico más allá lo descrito en las instrucciones de operación. Todo otro servicio deberá ser referido a personal de servicio calificado.
9. El aparato eléctrico debe ser situado de tal manera que su posición no interfiera su uso. La colocación del aparato eléctrico sobre una cama, sofá, alfombra o superficie similar puede bloquea la ventilación, no se debe colocar en libreros o gabinetes que impidan el flujo de aire por los orificios de ventilación.
10. El equipo eléctrico deber ser situado fuera del alcance de fuentes de calor como radiadores, registros de calor, estufas u otros aparatos (incluyendo amplificadores) que producen calor.
11. El aparato eléctrico deberá ser conectado a una fuente de poder sólo del tipo descrito en el instructivo de operación, o como se indique en el aparato.
12. Precaución debe ser tomada de tal manera que la tierra física y la polarización del equipo no sea eliminada.
13. Los cables de la fuente de poder deben ser guiados de tal manera que no sean pisados ni pellizcados por objetos colocados sobre o contra ellos, poniendo particular atención a los contactos y receptáculos donde salen del aparato.
14. El equipo eléctrico debe ser limpiado únicamente de acuerdo a las recomendaciones del fabricante.
15. En caso de existir, una antena externa deberá ser localizada lejos de las líneas de energía.
16. El cable de corriente deberá ser desconectado del cuando el equipo no sea usado por un largo periodo de tiempo.



17. Cuidado debe ser tomado de tal manera que objetos líquidos no sean derramados sobre la cubierta u orificios de ventilación.
18. Servicio por personal calificado deberá ser provisto cuando:
  - A: El cable de poder o el contacto ha sido dañado; u
  - B: Objetos han caído o líquido ha sido derramado dentro del aparato; o
  - C: El aparato ha sido expuesto a la lluvia; o
  - D: El aparato parece no operar normalmente o muestra un cambio en su desempeño; o
  - E: El aparato ha sido tirado o su cubierta ha sido dañada.

# Safety Instructions

---

## Safety Instructions

For reliable and safe long-term operation of your ServSwitch DKM FX, follow these guidelines:

### Installation

- Only use in dry, indoor environments.
- The ServSwitch DKM FX and the power supply units can get warm. Don't put them in an enclosed space without any airflow.
- Do not obscure ventilation holes.
- Only use power supplies originally supplied with the product or manufacturer-approved replacements. Do not use a power supply if it appears to be defective or has a damaged case.
- Connect all power supplies to grounded outlets. In each case, make sure that the ground connection is maintained from the outlet socket to the power supply's AC power input.
- Do not connect the link interface to any other equipment, particularly network or telecommunications equipment.
- Take any required ESD precautions.

### Repair

- Do not attempt to open or repair a power supply unit.
- Do not attempt to open or repair the ServSwitch DKM FX. There are no user-serviceable parts inside.
- Contact Black Box Technical Support at 724-746-5500 or [info@blackbox.com](mailto:info@blackbox.com) if there is a fault.

---

Chapter	Page
1. Specifications .....	10
1.1 Interfaces.....	10
1.1.1 DVI-D Single Link .....	10
1.1.2 USB HID .....	10
1.1.3 RJ-45 (Network).....	10
1.1.4 RS-232 (Serial).....	11
1.1.5 RJ-45 (Interconnect).....	11
1.1.6 Fiber SFP Type LC (Interconnect) .....	11
1.1.7 SDI (Interconnect).....	11
1.2 Interconnect Cable .....	11
1.2.1 CATx.....	11
1.2.2 Fiber .....	12
1.2.3 Coaxial .....	13
1.3 Supported Peripherals .....	14
1.4 Connector Pinouts.....	14
1.4.1 CPU Board.....	14
1.4.2 I/O Board CATx .....	16
1.4.3 I/O Board SFP.....	16
1.4.4 I/O Board SDI.....	16
1.5 Power Supply.....	17
1.6 Environmental Conditions.....	17
1.7 Size.....	17
1.8 Shipping Weight.....	17
2. Overview.....	18
2.1 Description .....	18
2.1.1 Application.....	18
2.1.2 Access Options.....	18
2.2 System Overview .....	19
2.3 Available Products .....	20
2.4 What's Included .....	20
2.5 Device Views .....	21
2.5.1 ServSwitch DKM FX 288-Port .....	21
2.5.2 ServSwitch DKM FX 160-Port .....	22
2.5.3 ServSwitch DKM FX 80-Port .....	23
2.5.4 ServSwitch DKM FX 48-Port.....	24

# Table of Contents

---

Chapter	Page
2.6 Diagnostics and Status .....	24
2.6.1 Status LEDs.....	24
2.6.2 Port Status.....	30
2.6.3 Network Status .....	33
2.6.4 Firmware Status.....	35
2.7 Trace Function .....	37
3. Installation .....	39
3.1 System Setup.....	39
3.2 Example Applications .....	40
3.2.1 KVM Matrix .....	40
3.2.2 Video Matrix .....	41
3.2.3 Parallel Operation (Stacking).....	42
3.2.4 Cascading .....	43
4. Configuration .....	45
4.1 Command Mode.....	45
4.2 Control Options.....	46
4.2.1 Control via OSD .....	46
4.2.2 Control via Java Tool .....	50
4.2.3 Control via Serial Interface .....	56
4.3 Assignment .....	56
4.3.1 Virtual CPU to Real CPU.....	56
4.3.2 Real Console to Virtual Console.....	58
4.4 System Settings .....	59
4.4.1 System Data .....	59
4.4.2 Automatic ID .....	62
4.4.3 Access .....	64
4.4.4 Switch .....	67
4.4.5 Network.....	70
4.4.6 Date and Time.....	72
4.5 User Settings.....	74
4.6 Extender Settings .....	77
4.7 CPU Settings.....	81
4.8 Console Settings.....	84
4.8.1 CON Devices .....	84
4.8.2 Mouse and Keyboard.....	88
4.9 Saving and Loading of Configurations.....	90
4.9.1 Active Configuration .....	90

---

Chapter	Page
4.9.2 Saving of Configurations (Internal).....	91
4.9.3 Loading of Configurations (Internal).....	93
4.9.4 Saving of Configurations (External).....	95
4.9.5 Loading of Configurations (External).....	96
4.10 Export and Import Options.....	97
4.10.1 Export Options.....	97
4.10.2 Import Options.....	98
4.11 Firmware Update.....	99
5. Operation.....	101
5.1 Operation via Hotkeys.....	101
5.1.1 Direct Switching.....	101
5.1.2 Scan Mode.....	102
5.1.3 Addressing of Master and Slave.....	102
5.1.4 Function Keys <F1>-<F12>.....	103
5.2 KVM Switching.....	103
5.3 Serial Interface.....	106
5.4 Power On and Power Down Functions.....	107
5.4.1 Restart.....	107
5.4.2 Reset.....	107
5.4.3 Power Down.....	107
6. Serial Control.....	108
7. Troubleshooting.....	120
7.1 External Failure.....	120
7.2 Video Interference.....	120
7.3 Fans Malfunction.....	120
7.4 Power Supply Units Malfunction.....	121
7.5 Network Error.....	121
7.6 ServSwitch DKM FX Failure.....	121
7.7 Blank Screen.....	122
7.8 Contacting Black Box.....	122
7.9 Shipping and Packaging.....	123
Appendix. Glossary.....	124

# Chapter 1: Specifications

---

## 1. Specifications

### 1.1 Interfaces

#### 1.1.1 DVI-D Single Link

The video interface supports the DVI-D protocol. All signals that comply with DVI-D single-link standard can be transmitted. This includes, for example, monitor resolutions such as 1920 x 1200 @ 60 Hz, Full HD (1080p), or 2K HD (up to 2048 x 1152). Data rate is limited to 165 MPixel/s.

#### 1.1.2 USB HID

Devices with USB HID interface support a maximum of two devices with USB HID protocol. Each USB HID port provides a maximum current of 100 mA.

##### **Keyboard**

Compatible with most USB keyboards. Certain keyboards with additional functions may require custom firmware to operate. Keyboards with an integral USB Hub (Mac® keyboards, for example) are also supported.

##### **Mouse**

Compatible with most 2-button, 3-button, and scroll mice.

##### **Other USB HID devices**

The proprietary USB emulation also supports certain other USB HID devices, such as specific touchscreens, graphics tablets, bar-code scanners, or special keyboards. Support cannot be guaranteed, however, for every USB HID device.

*NOTE: Only two USB HID devices are supported concurrently, such as keyboard and mouse or keyboard and touchscreen. A hub is allowed, but it does not increase the number of HID devices allowed.*

To support other USB “non-HID” devices, such as scanners, Web cams or memory devices, choose our devices with transparent USB support.

#### 1.1.3 RJ-45 (Network)

CATx device communication requires a 1000BASE-T connection. Pin the cable according to EIA/TIA-568-B (1000BASE-T) standard with RJ-45 connectors at both ends. All four wire pairs are used in both directions. The cabling is suitable for full-duplex operation. For the cable connection to a source (computer, CPU), use a cross-pinned network cable.

### 1.1.4 RS-232 (Serial)

The communication takes place with a transmission speed of up to 115.2 kbps, regardless of the file format. The transmission takes place with eight data bits and a stop bit, but without a parity bit. Limited hardware handshake (DSR) is possible.

### 1.1.5 RJ-45 (Interconnect)

CATx device communication requires a 1000BASE-T connection.

Connector wiring must comply with EIA/TIA-568-B (1000BASE-T), with RJ-45 connectors at both ends. All four wire pairs are used.

### 1.1.6 Fiber SFP Type LC (Interconnect)

Fiber device communication is performed via Gigabit SFPs connected to suitable fibers fitted with LC connectors (see Section 1.2.2).

*NOTE: The correct function of the device can only be guaranteed with SFPs provided by Black Box.*

*CAUTION: SFP modules can be damaged by electrostatic discharge (ESD). Follow ESD handling precautions.*

### 1.1.7 SDI (Interconnect)

SDI device communication requires a mini coax connection with mini BNC connectors or 3G SFPs with transmission speeds of 0.360 Gbps (SD-SDI, SMPTE 259M), 1.485 Gbps (HD-SDI, SMPTE 292M), and 2.70 Gbps (3G SDI).

## 1.2 Interconnect Cable

### 1.2.1 CATx

*NOTE: A point-to-point connection is required. Operation with several patch fields is possible. Routing over an active network component, such as an Ethernet hub, router, or ServSwitch DKM FX, is not allowed.*

- *Avoid routing CATx cables along power cables.*
- *If the site has three-phase AC power, make sure that the CPU Unit and CON Unit are on the same phase.*

*NOTE: To maintain regulatory EMC compliance, use correctly installed shielded CATx cable throughout the interconnection link.*

*NOTE: To maintain regulatory EMC compliance, all CATx cables need to carry ferrites on both cable ends close to the device.*

### Type of Interconnect Cable

The ServSwitch DKM FX requires interconnect cabling specified for Gigabit Ethernet (1000BASE-T). Use solid-core (24 AWG), shielded, CAT5e (or better) cable.

Table 1-1. CATx interconnect cable.

Cable Type	Description
CATx solid-core 24 AWG cable	This S/UTP (CAT5e) cable conforms to EIA/TIA-568-B. Uses four pairs of 24 AWG wires. Connects according to EIA/TIA-568-B (1000BASE-T).
CATx solid-core 26/8 AWG cable	This S/UTP (CAT5e) cable conforms to EIA/TIA-568-B. Uses four pairs of 26/8 AWG wires. Connects according to EIA/TIA-568-B (1000BASE-T).

*NOTE: You can use use type 26/8 AWG flexible cables (patch cables), but the maximum possible extension distance is cut in half.*

Table 1-2. Maximum acceptable cable length.

Cable Type	Distance
CATx 24 AWG installation cable	400 ft. (140 m)
CATx 26/8 AWG patch cable	200 ft. (70 m)

### 1.2.2 Fiber

*NOTE: A point-to-point connection is necessary. Operation with multiple patch panels is allowed. Routing over active network components, such as Ethernet hubs, ServSwitch DKM FXes, or routers, is not allowed.*

#### Type of Interconnect Cable

Table 1-3. Fiber interconnect cable.

Cable Type	Description
Single-mode, 9- $\mu$ m	<ul style="list-style-type: none"><li>• Two fibers, 9-<math>\mu</math>m</li><li>• In-house patch cable (EFN092)</li></ul>
Multimode 50- $\mu$ m	<ul style="list-style-type: none"><li>• Two fibers, 50-<math>\mu</math>m</li><li>• In-house patch cable (EFN6020)</li></ul>
Multimode 62.5- $\mu$ m	<ul style="list-style-type: none"><li>• Two fibers, 62.5-<math>\mu</math>m</li><li>• In-house patch cable (EFN116-LCLC)</li></ul>

*NOTE: Only use single-mode cables for fiber connections that are based on 3G SFPs.*



Table 1-4. Maximum acceptable fiber cable length.

Cable Type	Distance
Single-mode 9- $\mu$ m	32,800 ft. (10,000 m)
Multimode 50- $\mu$ m (OM3)	3280 ft. (1000 m)
Multimode 50- $\mu$ m	1300 ft. (400 m)
Multimode 62.5 $\mu$ m	650 ft. (200 m)

*NOTE: If you use single-mode SFPs with multimode fiber optic cable, you can double the maximum acceptable cable length.*

### Type of Connector

The fiber cable uses LC connectors.

#### 1.2.3 Coaxial

*NOTE: A point-to-point connection is necessary.*

Table 1-5. Coaxial interconnect cable.

Cable Type	Description
Mini coaxial cable, 18 AWG	RG-6 Impedance: 75 ohms

Table 1-6. Maximum acceptable coaxial cable length.

Bandwidth	Distance
0.270 Gbps	1312 ft. (400 m)
1.485 Gbps	459 ft. (140 m)
2.970 Gbps	394 ft. (120 m)

### Type of Connector

The coaxial cable uses mini BNC connectors.

# Chapter 1: Specifications

## 1.3 Supported Peripherals

You can use the KVM extenders described in Tables 1-7 and 1-8 with the ServSwitch DKM FX:

Table 1-7. KVM extender with CATx connection.

Product Code	Description
ACX1T-11-C	KVM CPU unit, single-head, 2x USB HID
ACX1R-11-C	KVM CON unit, single-head, 2x USB HID
ACX1T-11V-C	KVM CPU unit, single-head, DVI-I input (VGA), 2x USB HID
ACX1R-11V-C	KVM CON unit, single-head, IR receiver, 2x USB HID

Table 1-8. KVM extender with fiber (single-mode) connection.

Product Code	Description
ACX1T-11-SM	KVM CPU unit, single-head, 2x USB HID
ACX1R-11-SM	KVM CON unit, single-head, 2x USB HID
ACX1T-11V-SM	KVM CPU unit, single-head, DVI-I input (VGA), 2x USB HID
ACX1R-11V-SM	KVM CON unit, single-head, IR receiver, 2x USB HID

## 1.4 Connector Pinouts

### 1.4.1 CPU Board

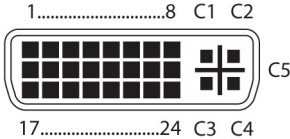

Figure 1-1. DVI-D single-link connector.

Table 1-9. DVI-D single-link connector pinout.

Pin	Signal	Pin	Signal	Pin	Signal
1	T.M.D.S. data 2-	9	T.M.D.S. data 1-	17	T.M.D.S. data 0-
2	T.M.D.S. data 2+	10	T.M.D.S. data 1+	18	T.M.D.S. data 0+
3	T.M.D.S. data 2 GND	11	T.M.D.S. data 1 GND	19	T.M.D.S. data 0 GND
4	Not connected	12	Not connected	20	Not connected
5	Not connected	13	Not connected	21	Not connected
6	DDC input (SCL)	14	+5 VDC high impedance	22	T.M.D.S. GND
7	DDC output (SDA)	15	GND	23	T.M.D.S. clock+
8	Internal use	16	Hot plug recognition	24	T.M.D.S. clock-
C1	Internal use	—	—	C3	Internal use
C2	Not connected	C5	GND	C4	Internal use

Table 1-10. USB Type A connector.

Picture	Pin	Signal	Color
	1	VCC (+5 VDC)	Red
	2	Data -	White
	3	Data +	Green
	4	GND	Black

Table 1-11. DB9 connector.

Picture	Pin	Signal	Color	Signal
	1	Not connected	6	DTR
	2	CTS	7	TxD
	3	RTS	8	RxD
	4	DSR	9	Not connected
	5	GND	—	—

Table 1-12. RJ-45 connector.

Picture	Pin	Signal	Color	Signal
	1	D1+	5	Not connected
	2	D1-	6	D2-
	3	D2+	7	Not connected
	4	Not connected	8	Not connected

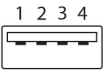
1.4.2 I/O Board CATx

Table 1-13. RJ-45 CATx connector.

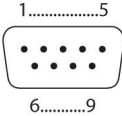
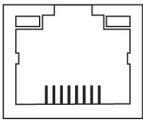
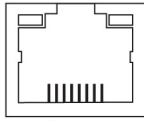
Picture	Pin	Signal	Color	Signal
	1	D1+	5	D3-
	2	D1-	6	D2-
	3	D2+	7	D4+
	4	D3+	8	D4-

1.4.3 I/O Board SFP

Table 1-14. RJ-45 connector.

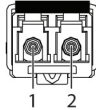
Picture	Diode	Signal
	1	Data OUT
	2	Data IN

1.4.4 I/O Board SDI

Table 1-15. RJ-45 connector.

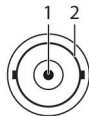
Picture	Pin	Signal
	1	Data In
	2	GND

### 1.5 Power Supply

**Power** — All models: Voltage: 100–240 VAC, 50–60 Hz;  
ACX288, ACX288-PS: 202 W max. without I/O boards;  
ACX160, ACX160-PS: 188 W max. without I/O boards;  
ACX080, ACX080-PS: 99 W max. without I/O boards;  
ACX048: 94 W max. without I/O boards;  
I/O boards (ACXI08-C, ACXI08-SM, ACXI08-SPF): 13 W max.

### 1.6 Environmental Conditions

**Temperature Tolerance** — +41 to +113° F (+5 to +45° C)

**Storage Temperature** — -13 to +140° F (-25 to +60° C)

**Relative Humidity** — Max. 80%, non-condensing

### 1.7 Size

**Size** — ACX288: 19"H x 22.8"W x 12"D (48.3 x 57.8 x 33 cm),  
Shipping box: 25.6"H x 26.8"W x 29.9"D (65 x 68 x 76 cm);  
ACX160: 19"H x 15.8"W x 12"D (48.3 x 40 x 33 cm),  
Shipping box: 25.6"H x 26.8"W x 12"D (65 x 68 x 54 cm);  
ACX080: 19"H x 7"W x 9.1"D (64 x 57 x 36 cm),  
Shipping box: 25.2"H x 22.4"W x 21.3"D (64 x 57 x 36 cm);  
ACX048: 19"H x 5.3"W x 9.1"D,  
Shipping box: 25.2" x 22.4"W x 12.4"D (64 x 57 x 23.1 cm)

### 1.8 Shipping Weight

**Weight** — ACX288: 76.2 lb (34.6 kg) fully equipped,  
Shipping box: 90.6 lb. (41.1 kg);  
ACX160: 60 lb. (26.3 kg) fully equipped,  
Shipping box: 69.9 lb. (31.7 kg);  
ACX080: 24.5 lb. (11.1 kg) fully equipped,  
Shipping box: 34.4 lb. (15.6 kg);  
ACX048: 19.6 lb. (8.9 kg),  
Shipping box: 26.7 lb. (12.1 kg)

## 2. Overview

### 2.1 Description

#### 2.1.1 Application

The ServSwitch DKM FX is used to establish connections from consoles (monitor, keyboard, mouse, and other peripheral devices) to various sources (computer, CPU).

In a maximum configuration, up to 288 independent ports can be defined and switched either as a console or a CPU.

The ServSwitch DKM FX is mainly specified for the use with extenders that are able to transmit video, KVM, and USB 2.0 signals. You can also use it as a video matrix.

For the connection between the ServSwitch DKM FX and the peripheral devices, such as KVM extenders or video sources, you can use CATx, fiber, or coaxial cables.

The ServSwitch DKM FX serves as a repeater. You can place it up to 6.2 miles (10 km) from the consoles and 6.2 miles (10 km) from the sources.

#### 2.1.2 Access Options

You have the following options to access the ServSwitch DKM FX for configuration and operation:

Table 2-1. Access options.

Access option	Symbol
OSD	
Java tool	
Serial interface	

## 2.2 System Overview

A ServSwitch DKM FX system consists of a ServSwitch DKM FX and, for KVM applications, one or more CPU units/CON units. The ServSwitch DKM FX is connected to the CPU units/CON units by interconnect cables or is connected directly to the video devices when used as a video matrix.

The CPU units connect directly to the sources (computer, CPU), using the included cables.

Monitor(s), keyboard, and mouse connect to the CON units.

The ServSwitch DKM FX and the CPU units/CON units communicate over CATx, fiber, or coaxial interconnect cables.

Figure 2-1 shows the system overview. Table 2-2 describes its components.

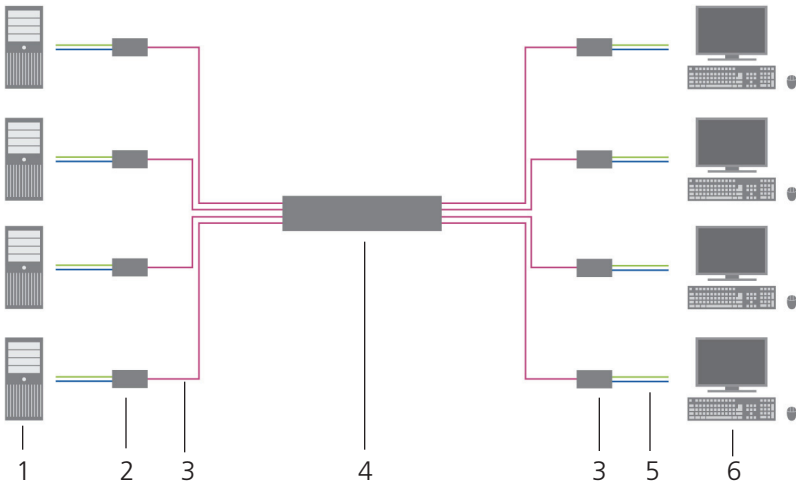

Figure 2-1. System overview.

Table 2-2. System components.

Number	Component
1	Source (computer, CPU)
2	CPU units
3	Interconnect cable
4	ServSwitch DKM FX
5	CON units
6	Console (monitor, keyboard, mouse)

## Chapter 2: Overview

---

See Section 3.2 for installation examples.

### 2.3 Available Products

Table 2-3. Available products.

Number	Description
<b>ServSwitch DKM FX</b>	
ACX048	ServSwitch DKM FX 48-port with control card and power supply
ACX080	ServSwitch DKM FX 80-port with control card and power supply
ACX160	ServSwitch DKM FX 160-port with control card and power supply
ACX288	ServSwitch DKM FX 288-port with control card and power supply
<b>Accessories</b>	
ACXIO8-C	8-port CATx input/output (I/O) module
ACXIO8-SM	8-port single-mode fiber input/output (I/O) module
ACXIO8-SFP	8-port single-mode fiber SFP input/output (I/O) module
ACX288-CTL	ServSwitch DKM FX controller card
ACXSFPC	CATx SFP module
ACXSFPS	Single-mode fiber SFP module
ACX080-PS	Power supply for ACX048 and ACX080
ACX160-PS	Power supply for ACX160
ACX288-PS	Power supply for ACX288
ACX080-FAN	Tray for 48/80 port console
ACX288-FAN	Tray for 160/288 port console

### 2.4 What's Included

Your package should contain the following items. If anything is missing or damaged, contact Black Box Technical Support at 724-746-5500 or [info@blackbox.com](mailto:info@blackbox.com).

- (1) ServSwitch DKM FX (ACX048, ACX080, ACX160, or ACX288)
- (1) power cord per built-in power supply unit
- (1) DKM FX controller card
- (1) serial control cable
- (1) set of mounting accessories
- This users' manual in PDF format and Java tool on CD-ROM



- (1) cross-wired CATx network cable

## 2.5 Device Views

In Sections 2.5.1 through 2.5.5, Figures 2-2 through 2-5 illustrate the ServSwitch DKM FX chassis models. Tables 2-4 through 2-8 describe their components.

### 2.5.1 ServSwitch DKM FX 288-Port

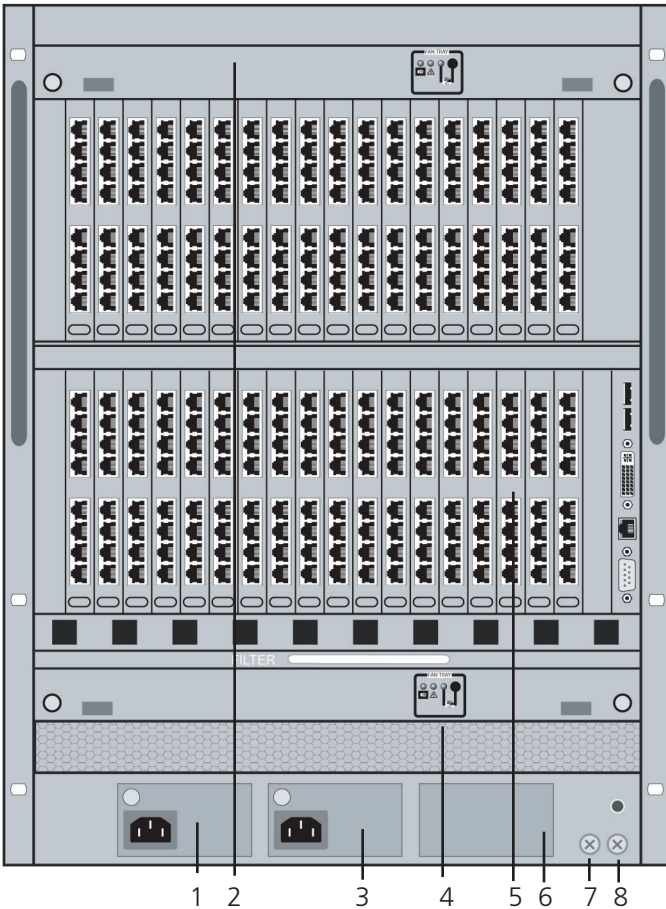

Figure 2-2. Front view, ACX288.

Table 2-4. ACX288 components.

Number	Component
1	Slot for Power Supply Unit 1
2	Slot for Fan Tray 1
3	Slot for Power Supply Unit 2
4	Slot for Fan Tray 2
5	Slot for I/O Boards 1–36
6	Slot for Power Supply Unit 3
7	Slot for CPU board
8	Grounding

2.5.2 ServSwitch DKM FX 160-Port

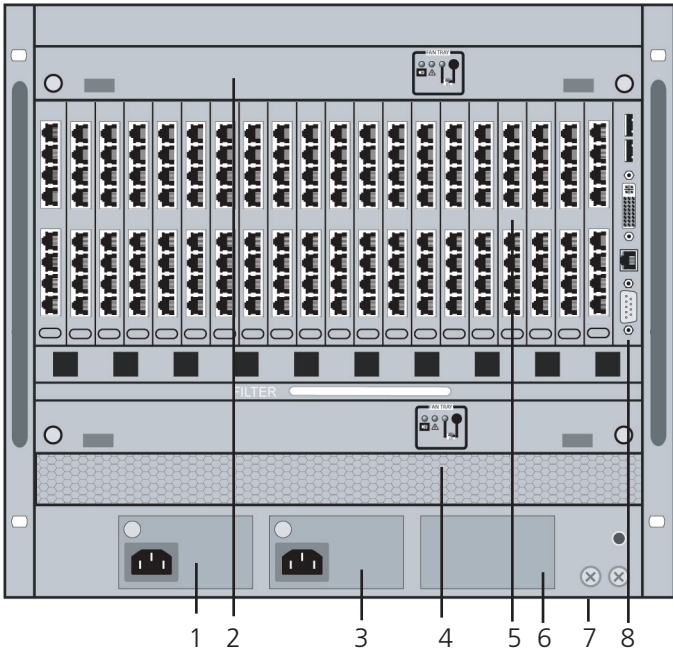

Figure 2-3. Front view, ACX160.

Table 2-5. ACX160 components.

Number	Component
1	Slot for Power Supply Unit 1
2	Slot for Fan Tray 1
3	Slot for Power Supply Unit 2
4	Slot for Fan Tray 2
5	Slot for I/O Boards 1–20
6	Slot for Power Supply Unit 3
7	Slot for CPU board
8	Grounding

2.5.3 ServSwitch DKM FX 80-Port

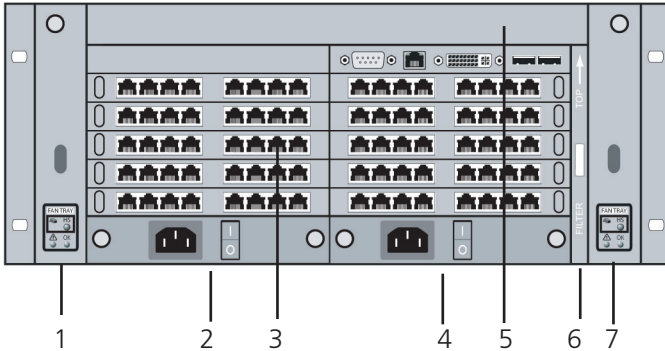

Figure 2-4. Front view, ACX080.

Table 2-6. ACX080 components.

Number	Component
1	Slot for fan tray
2	Slot for Power Supply Unit 1
3	Slot for I/O Boards 1–10
4	Slot for Power Supply Unit 2
5	Slot for CPU board
6	Slot for air filter
7	Slot for Fan Tray 2

## 2.5.4 ServSwitch DKM FX 48-Port

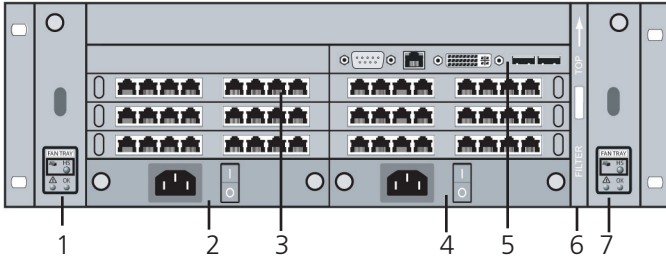

Figure 2-5. Front view, ACX048.

Table 2-7. ACX048 components.

Number	Component
1	Slot for fan tray
2	Slot for Power Supply Unit 1
3	Slot for I/O Boards 1–10
4	Slot for Power Supply Unit 2
5	Slot for CPU board
6	Slot for air filter
7	Slot for Fan Tray 2

## 2.6 Diagnostics and Status

### 2.6.1 Status LEDs

The ServSwitch DKM FX components LED indicators are shown in Figures 2-6 through 2-11, and described in Tables 2-8 through 2-13.

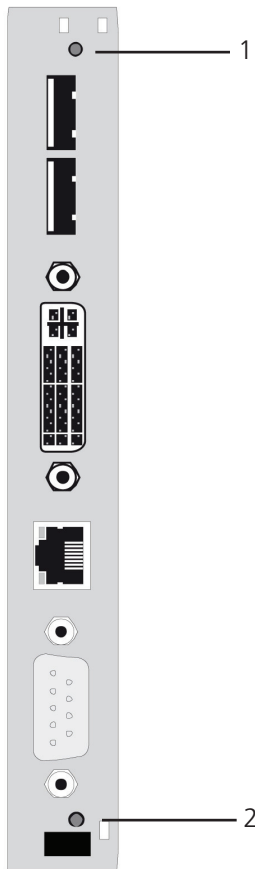

Figure 2-6. CPU board, front view.

Table 2-8. Status LEDs on the CPU board.

Number	LED	Status	Description
1	Status 1	White	CPU board is in registration process
		Blue flashing	Registration at the matrix is started
		Red flashing	Registration is in progress
		Green flashing	Operating condition
		Green	CPU board de-registered
2	Status 2	White	CPU board is in registration process
		Red flashing	Registration at the matrix is started
		Off	Operating condition

*NOTE: Because of variations in the LED type, "white" may also appear as light purple or light blue.*

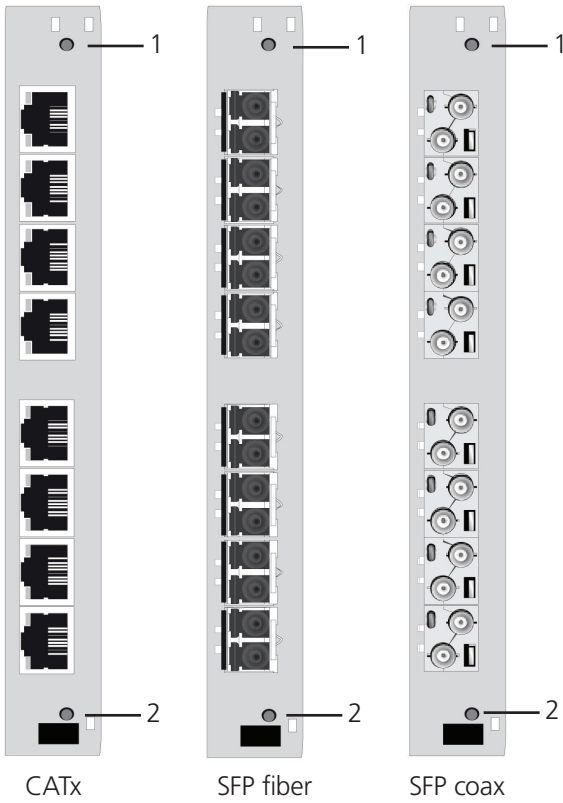

Figure 2-7. LEDs on the I/O boards.

Table 2-9. Status LEDs on the I/O boards.

Number	LED	Status	Description
1	Status 1	Light blue	I/O board in boot process
		Red flashing	I/O board in registration process
		Green flashing	Operating condition, I/O board registered at the matrix
		Green	I/O board de-registered (locking pin pulled out)
2	Status 2	White	I/O board in boot process
		Blue	I/O board in registration process
		Blue flashing	Operating condition, communication active with CPU board active
		Red flashing	I/O board de-registered (locking pin pulled out)

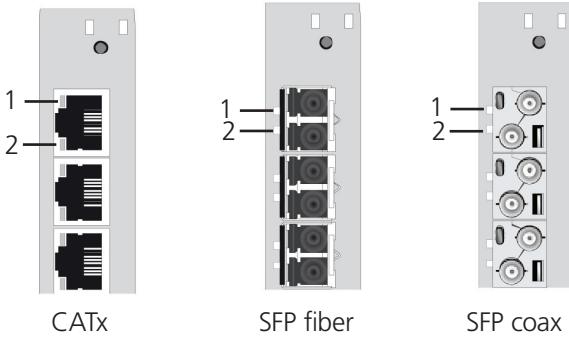

Figure 2-8. Ports status LEDs on the I/O boards.

Table 2-10. Port status LEDs on the I/O boards.

Number	LED	Status	Description
1	Link status (green)	Off	Port not activated
		Flashing	Port activated, no connection via interconnect cable
		On	Connection via interconnect cable OK, data traffic active
2	Link status (orange)	Off	Port not activated
		Flashing	Port activated, no connection via interconnect cable
		On	Connection via interconnect cable OK, data traffic active



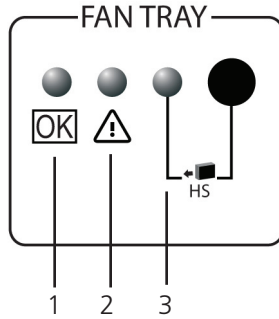

Figure 2-9. Status LEDs on the fan tray.

Table 2-11. Status LEDs on the fan tray.

Number	LED	Status	Description
1	Status 1 (green)	On	Operating condition
2	Status 2 (blue)	Off	Operating condition
		On	Error indication
3	Hot swap (blue)	Off	Hot swap option deactivated
		On	Hot swap option activated

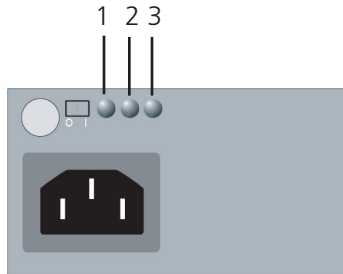

Figure 2-10. Status LEDs on the power supply unit (ACX288-PS or ACX160-PS).

Table 2-12. Status LEDs on the power supply unit (ACX288-PS or ACX160-PS).

Number	LED	Status	Description
1	AC input OK (green)	On	Operating condition
2	DC output OK (green)	On	Operating condition
3	O/T (yellow)	Off	Normal temperature
		On	High temperature

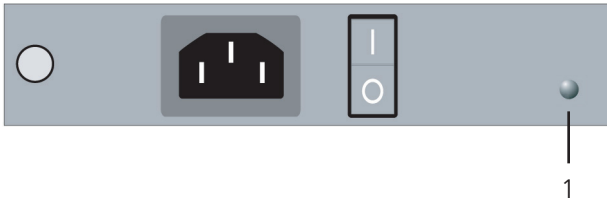

Figure 2-11. Status LEDs on the power supply unit (ACX080-PS).

Table 2-13. Status LEDs on the power supply unit (ACX080-PS).

Number	LED	Status	Description
1	DC input OK (green)	On	Operating condition
	DC output OK (green)	Off	No power supply

### 2.6.2 Port Status

The connections and the switching status between the various consoles and CPUs are shown in this menu.

You have the following possibilities to access the menu:



Figure 2-12. OSD and Java icons.

OSD

An on-screen display (abbreviated OSD) is an image superimposed on a screen picture, commonly used by modern television sets, VCRs, and DVD players to display information such as volume, channel, and time.

Java® Tool

The current port configuration of the ServSwitch DKM FX is illustrated in this menu.

Select Status > Matrix View in the task area in on-line mode.

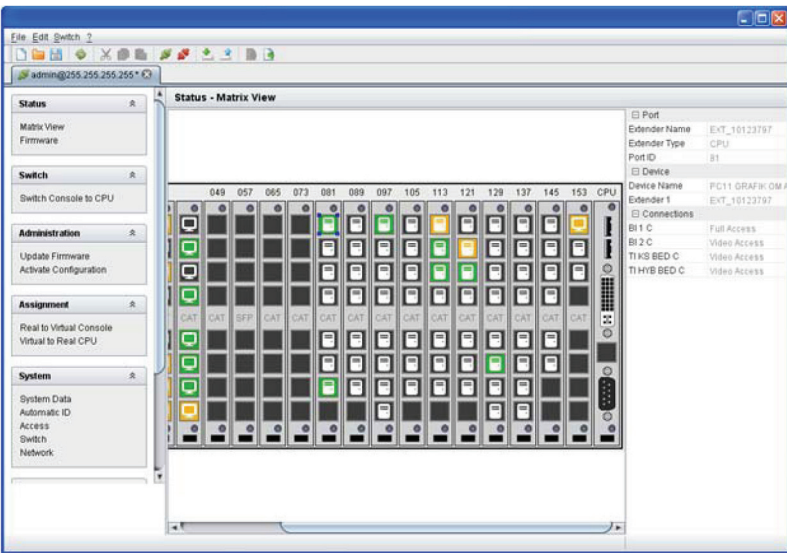

Figure 2-13. Menu Status—Matrix View screen.

Table 2-14. Connection status.





Color	Description
Black	Port not connected
Yellow	Video connection
Green	KVM connection

## Chapter 2: Overview

---

The symbol in Table 2-15 indicates the extender that is recognized and defined at a certain port:

Table 2-15. Extender recognized.

Symbol	Description
	Port connected to a CPU unit
	Port connected to a CON unit
	Port connected to a USB 2.0 CPU unit
	Port connected t a USB 2.0 CON unit

- Red framed ports are defined as “fixed” (for example, for USB 2.0 connections).
- The port with a static blue frame is currently selected.
- The ports with a flashing blue frame show the currently assigned connections.

*NOTE: To show the extender information of the currently selected port in the right part of the working area, press the left mouse button.*

The information in Table 2-16 is available:

Table 2-16. Extender information.

Symbol	Description
Extender name	Name of the selected extenders
Extender type	Type of the selected extender
Port ID	Number of the selected port
Device name	Name of the connected console or CPU
Connections	Listing of assigned connections to the marked port (full access or video access)

*NOTE: To open the context menu for the currently selected port with further functions, press the right mouse button.*

The context functions in Table 2-17 are available:

Table 2-17. Context functions.

Function	Description
Open extender	The menu for definition of the currently selected extender is opened
Open device	The menu for definition of the currently selected console or CPU is opened
Switch	The menu for execution of switching applications is opened

To reload the Matrix View, you have the following possibilities:

- Press the key <F5> of a connected keyboard
- Execute Edit > Reload in the menu bar
- Press the Button Reload in the tool bar

### 2.6.3 Network Status

The current network configuration is shown in this menu.

You have the following possibilities to access the menu:



Figure 2-14. OSD and Java icons.

## OSD

Select Status > Network in the main menu.

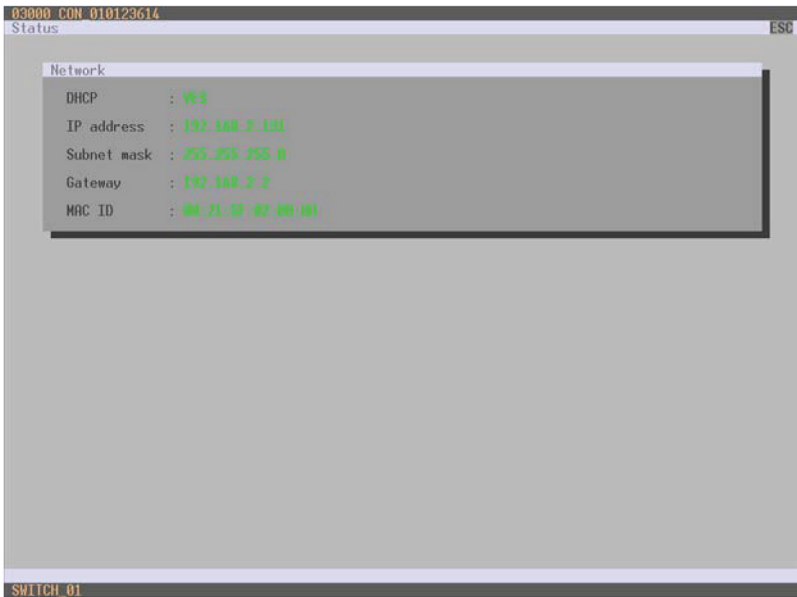

Figure 2-15. Status—Network screen.

The following information is shown in the Network Status menu:

Table 2-17. Network status.

Field	Description
DHCP	Information if the network settings are applied dynamically. Display Y (Yes) or N (No)
IP address	Information about the IP address as provided manually or via DHCP
Subnet mask	Information about the subnet mask as provided manually or via DHCP
Gateway	Information about the gateway address as provided manually or via DHCP
MAC ID	Information about the MAC address in the matrix

## Java Tool

1. Select Status > Matrix View in the task area.

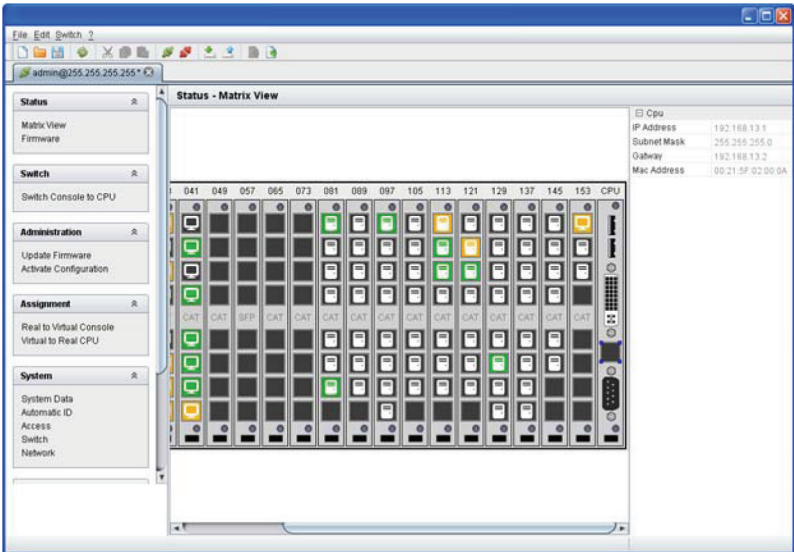

Figure 2-16. Menu status—matrix view.

2. Use the left mouse button to click on the network port of the CPU board. The corresponding network status will be shown in the right part of the working area.

### 2.6.4 Firmware Status

The current firmware status of the installed boards is shown in this menu.

You have the following possibilities to access the menu:



Figure 2-17. OSD and Java icons.

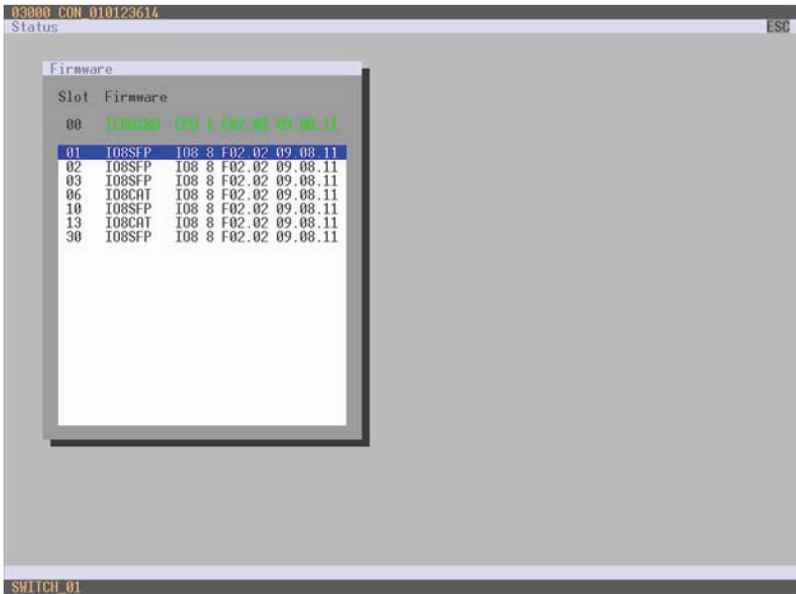

Figure 2-18. Menu status—firmware.

Table 2-18. Menu status—firmware.

Field	Description
Name	Description of the modules
Type	Type number
Ports	Number of ports
Version	Complete description of the firmware version
Date	Date of the firmware version
Status	Module status



## Java Tool

1. Select Status > Slot Table in the task area.

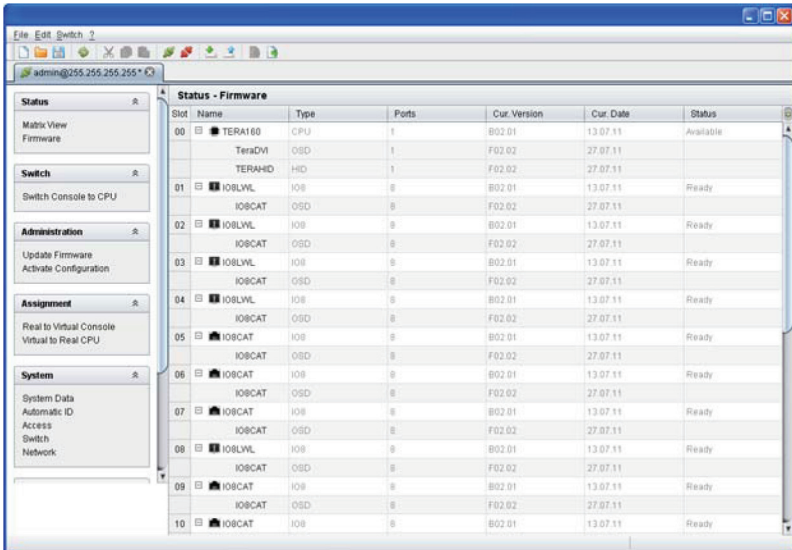

The screenshot shows a Java tool window titled 'admin@255.255.255.255\* C:\'. The main area displays the 'Status - Firmware' menu, which is expanded to show a table of slot information. The table has columns for Slot, Name, Type, Ports, Cur. Version, Cur. Date, and Status. The data is as follows:

Slot	Name	Type	Ports	Cur. Version	Cur. Date	Status
00	TERA160	CPU	1	B02.01	13.07.11	Available
	TeraDVI	OSD	1	F02.02	27.07.11	
	TERAHID	HID	1	F02.02	27.07.11	
01	IOBLWL	IOB	8	B02.01	13.07.11	Ready
	IOBCAT	OSD	8	F02.02	27.07.11	
02	IOBLWL	IOB	8	B02.01	13.07.11	Ready
	IOBCAT	OSD	8	F02.02	27.07.11	
03	IOBLWL	IOB	8	B02.01	13.07.11	Ready
	IOBCAT	OSD	8	F02.02	27.07.11	
04	IOBLWL	IOB	8	B02.01	13.07.11	Ready
	IOBCAT	OSD	8	F02.02	27.07.11	
05	IOBCAT	IOB	8	B02.01	13.07.11	Ready
	IOBCAT	OSD	8	F02.02	27.07.11	
06	IOBCAT	IOB	8	B02.01	13.07.11	Ready
	IOBCAT	OSD	8	F02.02	27.07.11	
07	IOBCAT	IOB	8	B02.01	13.07.11	Ready
	IOBCAT	OSD	8	F02.02	27.07.11	
08	IOBLWL	IOB	8	B02.01	13.07.11	Ready
	IOBCAT	OSD	8	F02.02	27.07.11	
09	IOBCAT	IOB	8	B02.01	13.07.11	Ready
	IOBCAT	OSD	8	F02.02	27.07.11	
10	IOBCAT	IOB	8	B02.01	13.07.11	Ready

Figure 2-19. Menu Status—Slot Table.

2. To read out the firmware status and store it locally (file extension .dtf), select Switch > Save Firmware Status to File....
3. To read out the overall status of the ServSwitch DKM FX and store it locally (file extension .zip), select Switch > Save Status to File....

The various modules can be expanded and retracted in the column Name by clicking with the left mouse button on the plus or minus symbols to get a better overview.

By clicking on the plus/minus symbol in the upper right corner of the working area, you can expand and retract all module information with one click at the left mouse button.

### 2.7 Trace Function

All events—for example, activities and switching operations of the ServSwitch DKM FX—are logged and displayed in this menu.

This function is used for diagnostic purposes.

You can request various trace views in the menu:



Figure 2-20. OSD icon.

The following information is shown in this menu:

Table 2-20. Trace menu function.

Field	Description
Time	Timestamp
Message	Detailed description of the event

### Trace possibilities

- Select Status > Trace IO Board in the main menu to check the events on your current I/O boards.
- Select Status > Trace Matrix to check the ServSwitch DKM FX events.

### 3. Installation

#### 3.1 System Setup

*NOTE: If you are a first-time user, we recommend that you set up the system in the same room as a test setup. This will allow you to identify and solve any cabling problems, and experiment with your system more conveniently.*

##### **Setup of the ServSwitch DKM FX**

1. Install the CPU and I/O boards.
2. Connect the keyboard, mouse, and monitor to the CPU board of the ServSwitch DKM FX.
3. Connect the ServSwitch DKM FX to the power supply.
4. Open OSD via hotkey and log in with administrator rights in the main menu under configuration (see Section 4.2.1).
5. Configure initially as requested.

*NOTE: After configuring the system, we recommend that you save the configuration by selecting Configuration > Save and restart the ServSwitch DKM FX by selecting Restart Matrix.*

6. Optional: Establish a network connection between the ServSwitch DKM FX and the Java tool to set an extended configuration (see Section 4.2.2).

##### **Setup of Extender**

1. Connect the CON units to the ServSwitch DKM FX by using the interconnect cables (CATx or fiber).
2. Connect the CON units to the input devices to be used (for example, keyboard and mouse).
3. Connect the 5-VDC power supply units to the CON units.
4. Check the basic function of the CON unit by opening the OSD via hotkey.
5. Connect the source (computer, CPU) to the CPU unit of the extender by using the provided connection cables.
6. Connect the CPU unit to the ServSwitch DKM FX by using the provided interconnect cables (CATx or fiber).

7. If you have a video matrix, connect the video source directly to the ServSwitch DKM FX by using the interconnect cables (coax, fiber).
8. Connect the 5-VDC power supply units to the CPU units.
9. Start the system.

### 3.2 Example Applications

The ServSwitch DKM FX supports a flexible configuration of your system environment:

For example, part of the ServSwitch DKM FX can be configured as a single-head workstation, part as dual-head, or quad-head, or even as a video ServSwitch DKM FX. You can also configure KVM and USB 2.0.

In addition to the access via OSD by the keyboard connected to the CPU board or an extender CON unit, you have the following access options:

- via Java Tool
- via serial interface

A connection to common media controls is possible, too.

Sections 3.2.1 through 3.2.5 describe typical installations of the ServSwitch DKM FX.

#### 3.2.1 KVM Matrix

In single-head mode, up to 288 ports can be used either as an input or as an output port, depending on components and equipment. At the same time, all users have non-blocking access (user access is not limited by the activities of another user).

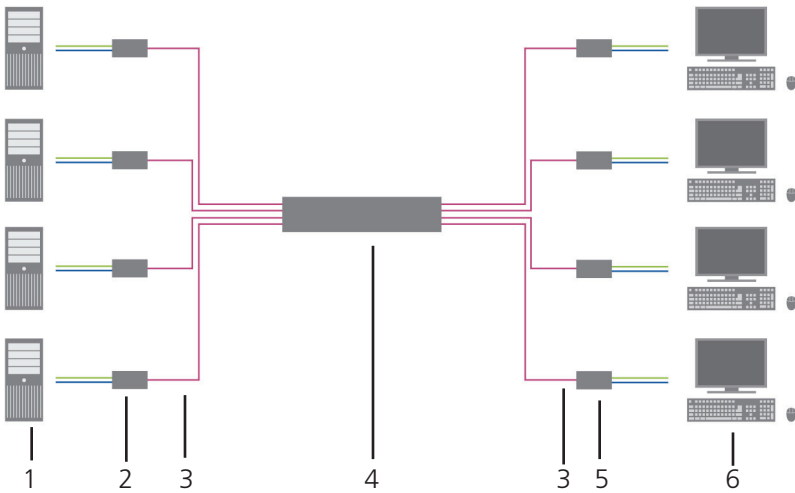

Figure 3-1. KVM using ServSwitch DKM FX application.

Table 3-1. Single-head KVM matrix components.

Number	Description
1	Source (computers, CPU)
2	CPU units
3	Interconnect cable
4	ServSwitch DKM FX
5	CON units
6	Consoles (monitor, keyboard, mouse)

If you have a single-head console, you can also access a dual-head or quad-head console. However, you can control the system only at Monitor 1.

Any signal source can be switched to any number of monitors that will show the video signal at the same time. Even (optional) audio can be switched.

### 3.2.2 Video Matrix

If you use the ServSwitch DKM FX as a video matrix, it can switch up to 288 input ports to up to 288 output ports, depending on components and equipment.

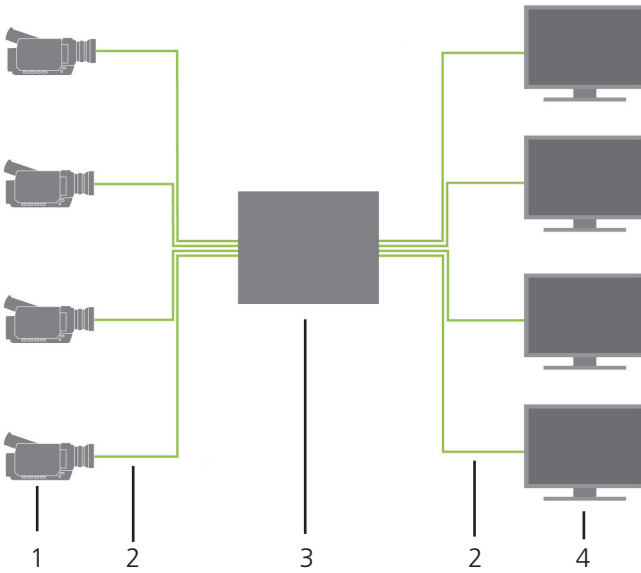

Figure 3-2. Video using ServSwitch DKM FX application.

Table 3-2. Video matrix components.

Number	Description
1	Video sources, for example, an SDI camera
2	Interconnect cable
3	ServSwitch DKM FX
4	Video sinks, for example, a monitor

### 3.2.3 Parallel Operation (Stacking)

If you have special configurations, especially at installations with several monitors per workstation, or you need additional support for USB 2.0 transmission paths, you can increase the number of CPUs and consoles connected using a parallel operation (stacking) of several ServSwitch DKM FX devices.

One of the ServSwitch DKM FX matrices has to be defined as the master ServSwitch DKM FX, and all the others have to be configured as slaves (see Section 4.4.1) and must be connected to the master ServSwitch DKM FX via a network.

If you send a switching command via the OSD, the slave matrices will also switch.

*NOTE: Switching of stacked devices might be delayed by several seconds.*

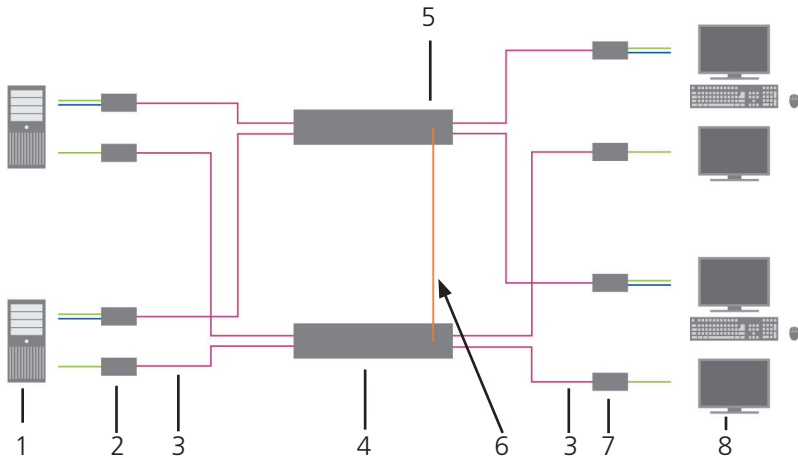

Figure 3-3. Parallel operation (stacking) application.

Table 3-3. Parallel operation (stacking) components.

Number	Description
1	Dual-head source computer, CPU
2	CPU units
3	Interconnect cable
4	ServSwitch DKM FX (master)
5	ServSwitch DKM FX (slave)
6	Network connection master/slave(s)
7	CON units
8	Console (two monitors, keyboards, and mice)

### 3.2.4 Cascading

For applications that exceed the number of available ports, you can extend the system by cascading.

In this case, the ServSwitch DKM FX devices are connected by so-called “tie lines.” The tie lines are dynamically configured to support connections in both directions.

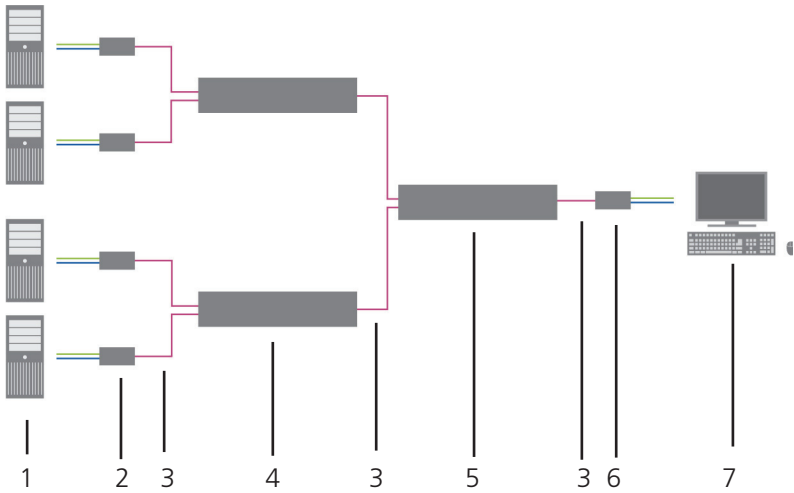

Figure 3-4. Cascading application.

Table 3-4. Cascading components.

Number	Description
1	Source (computer, CPU)
2	CPU units
3	Interconnect cable
4	ServSwitch DKM FX (slave)
5	ServSwitch DKM FX (master)
6	CON unit
7	Console (monitor, keyboard, mouse)



## 4. Configuration

### 4.1 Command Mode

The ServSwitch DKM FX has a Command Mode that enables several functions via keyboard command during normal use.

To enter Command Mode, use a hotkey sequence and to exit Command Mode, press <Esc>. While in Command Mode, the Shift and Scroll LEDs on the console keyboard will flash.

*NOTE: In Command Mode, normal keyboard and mouse operation will cease. Only selected keyboard commands are available.*

The following table lists the keyboard commands to enter and to exit Command Mode and to change the hotkey sequence:

Table 4-1. Command mode components.

Function	Keyboard command
Enter Command Mode (default)	2x <Right-Shift> (or hotkey)
Exit Command Mode	<Esc>
Change hotkey sequence	<Left-Ctrl> + <Left-Shift> + <C>, <hotkey code>, <Enter> Since 8/10/2011: <current hotkey> + <C>, <new hotkey code>, <Enter>

*NOTE: <Key> + <Key> = Press keys simultaneously; <Key>, <Key> = Press keys successively, 2x <Key> = Press key quickly, twice in a row (similar to a mouse double-click).*

You can change the hotkey sequence to enter Command Mode. The following table lists the hotkey codes for the available key sequences:

Table 4-2. Command mode components.

Hotkey code	Hotkey
1	<Left-Ctrl> + <Left-Shift> + <i>
2	2x <Scroll>
3	2x <Left-Shift>
4	2x <Left-Ctrl>
5	2x <Left-Alt>
6	2x <Right-Shift>
7	2x <Right-Ctrl>
8	2x <Right-Alt>

*NOTE: In a combined KVM matrix/U-Switch configuration, choose different hotkeys for the KVM matrix and the U-Switch.*

## 4.2 Control Options

The ServSwitch DKM FX contains an internal CPU that enables you to control all functions from any console without the need for an external CPU or media control.

You have the following possibilities to access the ServSwitch DKM FX for configuration and operation:

- via OSD
- via Java Tool
- via serial interface

### 4.2.1 Control via OSD



Figure 4-1. OSD icon.

Via OSD (on-screen display), you set the configuration of the ServSwitch DKM FX operating system. The settings of the Configuration menu are described in this chapter. All other menus are described in later chapters.

You can enter the OSD of the ServSwitch DKM FX:

- via keyboard connected to the CPU board
- via keyboard connected to a CON unit of an extender

### Entering OSD

1. Start Command Mode with the hotkey (see Section 5.1).
2. Press <O> to open OSD. You will see a list of all available CPUs as a start menu.
3. Press <Esc> to enter the main menu.

### Leaving OSD

- Press <Shift> + <Esc> simultaneously. The OSD will close without any further changes and the currently active CPU connection will display.

### Menu Structure

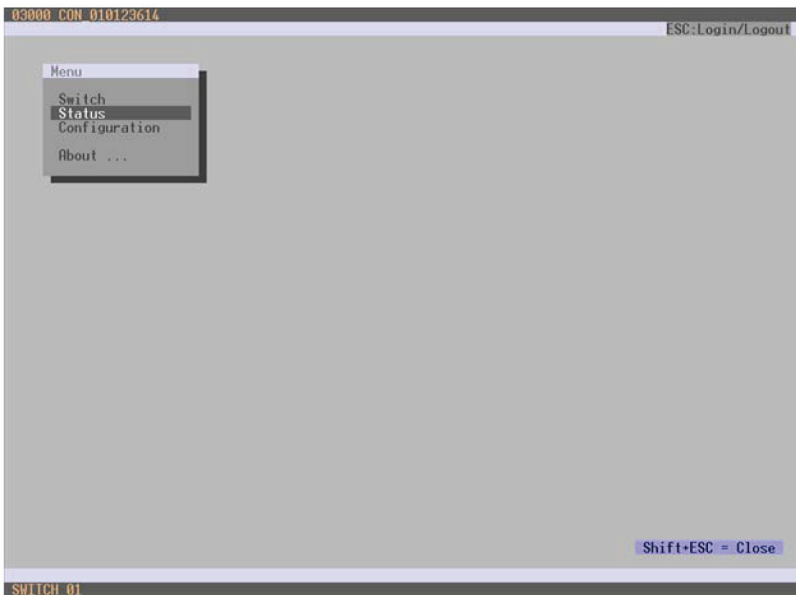

Figure 4-2. Menu structure.

The general layout of the OSD is structured into three areas:

- Upper status area (top-most two text lines)
- Working area

# Chapter 4: Configuration

---

- Lower status area (lowest two text lines)

## Keyboard control

You can select between the following keyboard commands:

Table 4-3. Keyboard commands.

Function	Keyboard command
Left cursor—only within an input field or a switching screen	<Cursor-Left>
Right cursor—only within an input field or a switching screen	<Cursor-Right>
<ul style="list-style-type: none"><li>• In input fields: Line up (with wrap-around)</li><li>• In menus: Line up (without wrap-around)</li></ul>	<Cursor-Up>
<ul style="list-style-type: none"><li>• In input fields: Line down (with wrap-around)</li><li>• In menus: Line down (without wrap-around)</li></ul>	<Cursor-Down>
Previous page in menus with more than one page	<Page-Up>
Next page in menus with more than one page	<Page-Down>
Next input field	<Tab>
Previous input field	<Left-Shift> + <Tab>
Next option in selection fields	<+>
Previous option in selection fields	<->
Switching in selection fields between two conditions, for example, between ON/OFF or Y(Yes)/N(No)	<Space>
<ul style="list-style-type: none"><li>• In menus with input fields: Save data</li><li>• In menus: Select menu item</li></ul>	<Enter>
<ul style="list-style-type: none"><li>• In menus with input fields: Cancel data</li><li>• In menus with selection fields: Go back to the superior menu</li></ul>	<Esc>

## Sorting Function

You can sort lists and tables in the Java Tool.

Table 4-4. Sorting functions.

Function	Keyboard command
Sort ID numbers in a descending order or in an ascending order by pressing the keyboard command twice (ID)	<F1>
Sort ID names in a descending order or in an ascending order by pressing the keyboard command twice (Name)	<F2>
Go to the next result in the list of results for the search field (Next)	<F3>
Go to the previous result in the list of results for the search field (Previous)	<F3>
Refresh the currently shown list (Previous)	<F4>
Refresh the currently shown field (Refresh)	<F5>
Jump between the search field and the list of results (Find)	<F6>

### Password request

You have to log in with administrator rights to be able to set configurations.

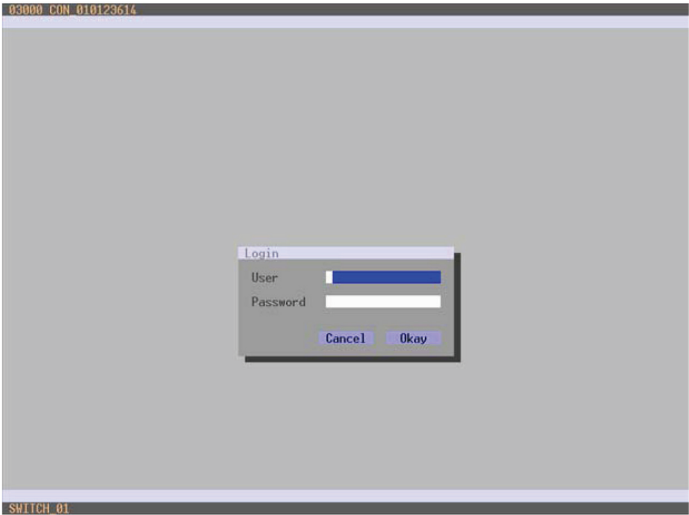

Figure 4-3. Login Menu screen.

Access to the configuration menu requires administrator rights. User login is mandatory.

Table 4-5. Menu login parameters.

Field	Input
User	admin
Password	admin

*NOTE: For security reasons, change the administrator password as soon as possible.*

## 4.2.2 Control via Java Tool



Figure 4-4. Java icon.

### Requirements

If you want to use the Java tool, you need these items:

- Computer with an executable Java tool and an installed Java Runtime Environment (JRE, version 1.6 or higher)
- Java Tool software
- Available network connection between the Java tool and the ServSwitch DKM FX

*NOTE: Contact your system administrator concerning JRE and network connection.*

### Installation of the Java Tool

The Java tool is available as a single executable program file that does not require a separate installation.

Copy the tool after receiving the file to a directory on your computer.

*NOTE: If you do not have a Java tool, contact Black Box Technical Support at 724-746-5500 or [info@blackbox.com](mailto:info@blackbox.com).*

### Computer Connection to the ServSwitch DKM FX

*NOTE: For a direct connection between the computer and ServSwitch DKM FX, use a cross-wired network cable.*

*For a connection between the computer and ServSwitch DKM FX via switch or hub, use a straight-pinned network cable.*

Connect the network cable to the RJ-45 ports of the computer and CPU board of the ServSwitch DKM FX.

**Start of the Java Tool**

Open the Java tool by a double click on the program icon or use the <Enter> key on the keyboard.

**Connection to the ServSwitch DKM FX**

*NOTE: Administrator rights are required.*

1. Open the Java tool.
2. Select Switch > Connect in the menu bar.
3. Enter the IP address in the popup input field according to the network configuration of the ServSwitch DKM FX (see Section 4.2.3).
4. Enter the user name and password for the ServSwitch DKM FX (see Section 4.4.1).
5. Confirm your inputs with the button "OK" or reject with "Cancel."

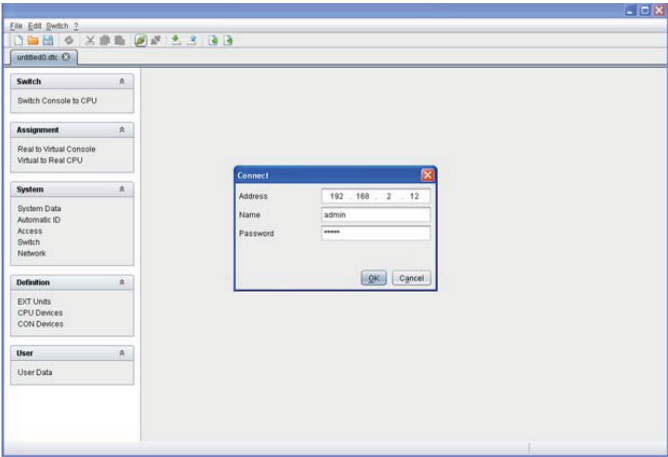

Figure 4-5. Menu Connection screen.

## Menu structure

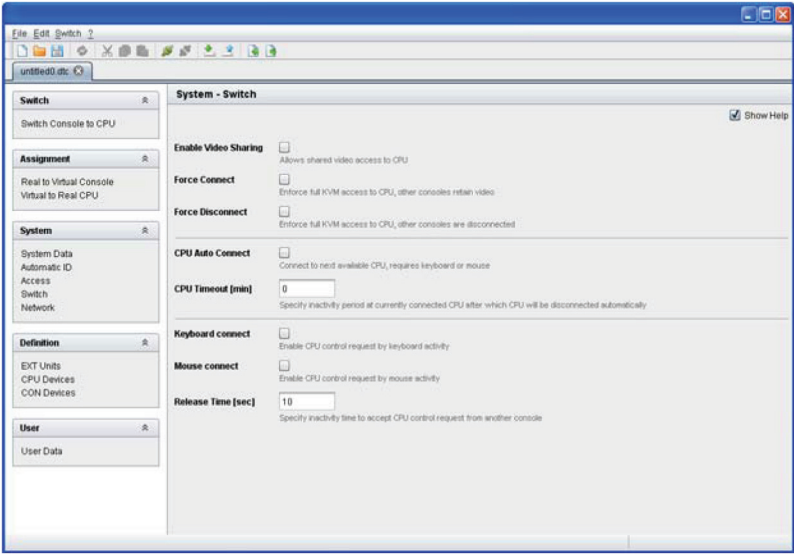

Figure 4-6. Example menu view (system-switch).

The menu structure of the Java tools is subdivided into various sections:

- Menu bar (top line)
- Toolbar (second line)
- Tab bar (third line)
- Task area (left menu section)
- Working area (right menu section)
- Status bar (bottom line section)

### Operating Instructions

The operation of the Java tool is intuitive and corresponds to the user interface of common operating systems.

The Java tool contains its own support function.

This ServSwitch DKM FX manual only describes how to find and open the appropriate menus in the Java tool. For further operation, use the support function of the tool.



You can activate or deactivate the integrated help texts in the working area of the Java tool by checking the box in the upper right corner.

## Mouse Control

You can select between the following mouse commands:

Table 4-6. Mouse commands.

Function	Mouse command
Menu selection, marking	Left mouse button
Open function-specific selection menus	Double-click the left mouse button
Open content-specific selection menus	Right mouse button

## Keyboard Control

You can select between the following keyboard commands:

Table 4-7. Keyboard commands.

Function	Keyboard command
Cursor to the left	<Cursor Left>
Cursor to the right	<Cursor Right>
Line up	<Cursor Up>
Line down	<Cursor Down>
Previous page in input or status menus with more than one page	<Page Up>
Next page in input or status menus with more than one page	<Page Down>
Next field in input menus	<Tab>
Previous field in input menus	<Left-Shift> + <Tab>
<ul style="list-style-type: none"> <li>Switching in selection fields between two conditions (checkmark or not)</li> <li>Open already marked fields with editing or selecting capability</li> </ul>	<Space>
<ul style="list-style-type: none"> <li>In menus: data saving</li> <li>Menu item selection</li> </ul>	<Enter>
<ul style="list-style-type: none"> <li>Leave tables</li> <li>Jump from tables into the next field</li> </ul>	<Ctrl> + <Tab>

Table 4-7 (Continued). Keyboard commands.

Function	Keyboard command
<ul style="list-style-type: none"><li>• Leave tables</li><li>• Jump from tables into the previous filed</li></ul>	<Ctrl> + <Left-Shift> + <Tab>
Open content-specific selection menus	Right mouse button

*NOTE: Various functions within the menus in the menu bar can be executed with the provided keyboard commands (for example, press <Ctrl> + <S> to execute Save) that are listed to the right of the respective menu item.*

### Reload Options

The information shown in the Java tool can be reloaded in different ways.

- Via <F5> key on the used keyboard
- Via Edit > Reload in the menu bar
- Via “Reload” Symbol in the symbol bar

### Context Function

The Java tool offers several context functions that support a user friendly and effective operation of the tool. The context functions are described in the respective chapters.

To execute a context function, use the right mouse button on the corresponding field and select the desired function.

### Sorting Function

Lists and tables in the Java tool offer a sorting function for fast and smooth search.

1. For ascending sort status, use the left mouse button once to click into the header of the column you want to sort.

The sort status is indicated by an arrow that points upwards.

2. For descending sort, use the left mouse button twice to click on the header of the column that you want to sort. The sort is displayed by an arrow that points downwards.

3. To cancel the sort, use the left mouse button once or twice to click on the header of the column that is sorted until the displayed arrow disappears.

### Filter Function

Lists and tables in the Java tool offer a filter function that enables a fast and smooth search.

1. To activate a filter, use the right mouse button to click on the header of the column you want to filter and select Set Filter.
2. Write the word or part of a word you want to filter directly into the header.  
The filter results are shown immediately.
3. To delete a filter, use the right mouse button to click on the header of the column you want to filter and select Clear Filter.

*NOTE: An asterisk in the header indicates an active filter.*

*The filter function is based on the functional principle of common Web search engines.*

### Configuration in the Java Tool

You can only change configuration and system settings via Java tool in off-line mode without a direct connection between ServSwitch DKM FX and Java tool.

To activate a configuration in the ServSwitch DKM FX:

1. Select "File > Upload to" in the menu bar.
2. Enter the IP address of the ServSwitch DKM FX (see Section 4.2.3) and the name and password of the user authorization and select the storage location of the new configuration (default or config01-08) in the menu "Select Configuration."
3. Select "Switch > Connect" in the menu bar and enter the IP address of the matrix and the name and password for user authorization.
4. Select "Administration > Activate Configuration" in the task area and select the storage location that you selected above.
5. Use the "Activate" button to open the selected configuration within the matrix.

The connection and the open tab will close, and the matrix will restart.

*NOTE: During the activation of a configuration, the matrix is temporarily not available.*

### 4.2.3 Control via Serial Interface



Figure 4-7. RS-232 icon.

The ServSwitch DKM FX operating system offers various functions for operation via serial interface. There are telegrams for switching single or all connections available, both unidirectional and bidirectional. There are also telegrams for an overall definition of the total switching status and for saving and loading such switching states.

The ServSwitch DKM FX has an option that provides an echo of all affected switching operations via serial interface or network interface. It enables you to track the current configurations of the matrix at any time so you can update your own applications.

You can also switch ServSwitch DKM FX clones as slaves (stacking) in parallel via a serial network interface.

### 4.3 Assignment

The ServSwitch DKM FX enables you to create a console-specific or a CPU-specific assignment.

- You can assign virtual CPUs to real CPUs.
- You can assign real consoles to virtual consoles.

#### 4.3.1 Virtual CPU to real CPU

Switch several consoles to the same CPU. If there are several consoles connected to a virtual CPU that is assigned to a real CPU, you will only have to change the real CPU once and all the consoles will receive the video signal of the new CPU.

You can access the menu via OSD or Java.



Figure 4-8. OSD and Java icons.

Java Tool

Select "Assignment > Virtual to Real CPU" in the task area.

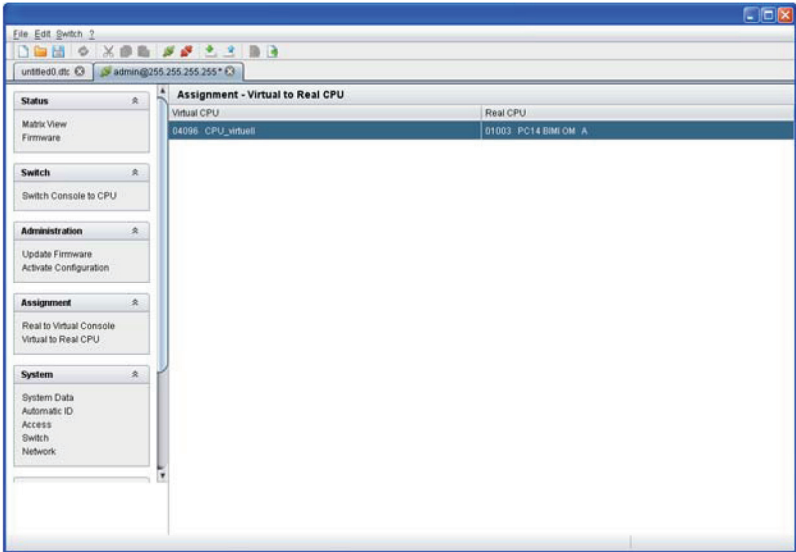

Figure 4-9. Menu assignment—Virtual to Real CPU screen.

For an assignment, proceed as follows:

- 1. Select a virtual CPU in the "Virtual CPU" list.
- 2. Double-click in the "Real CPU" column to get a list of all available real CPUs.
- 3. Select a real CPU.

You can select between the following buttons:

Table 4-8. Selection buttons.

Button	Function
Send	Send assignments to the matrix
Reload	Reload changes

*NOTE: By activating the Auto Send function in the left lower corner of the working area, switching operations will occur immediately without pressing the Send button to confirm.*

## Chapter 4: Configuration

The selection boxes in the Real CPU column contain a filter function for an easy selection of single consoles from a larger pool of consoles (see Section 4.2.2).

The Java tool additionally offers the possibility to go directly from the Assignment menu to the Definition menu to check specific settings for the respective console or CPU.

Use the right mouse button to select the respective console or CPU and select “Open CON Device” or “Open CPU Device.”

### 4.3.2 Real Console to Virtual Console

You can assign real consoles to virtual consoles in this menu.

Using this function, you can change access permissions of the virtual console and apply them to all assigned real consoles, too.

You can access the menu via OSD or Java.



Figure 4-10. OSD and Java icons.

### Java Tool

Select “Assignment > Real to Virtual Console” in the task area.

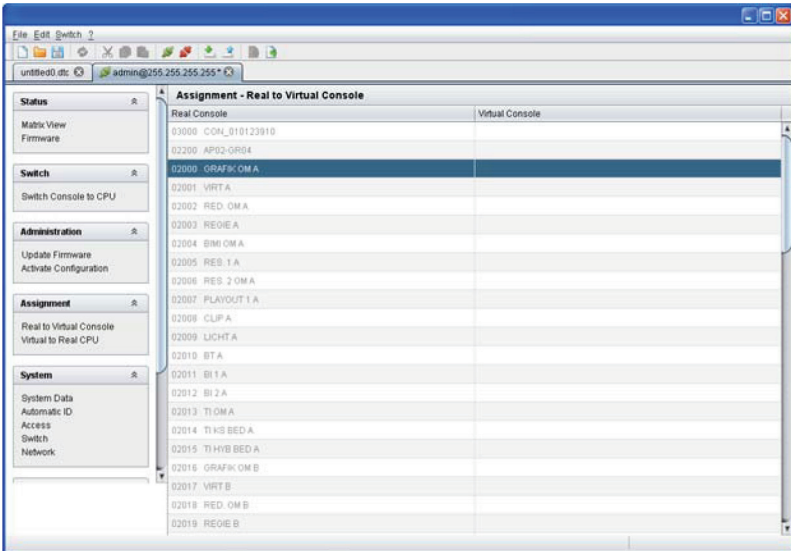

Figure 4-11. Menu Assignment—Real to Virtual Console screen.

To place an assignment, proceed as follows:

1. Select the required real console in the table Real Console.
2. Double-click in the Virtual Console column to get a list of all available virtual consoles.
3. Select the required virtual console.

You can select between the following buttons:

Table 4-9. Send and Cancel selection buttons.

Button	Function
Send	Send assignments to the matrix
Cancel	Reject changes

*NOTE: If you activate the Auto Send function in the left lower corner of the working area, switching operations will occur automatically without pressing the Send button to confirm.*

The selection boxes in the Virtual Console column contain a filter function so you can easily select a single CPU from a larger pool of CPUs (see Section 4.2.2).

#### 4.4 System Settings

You can configure the following system settings at the ServSwitch DKM FX.

*NOTE: Only users with administrator rights can configure the system settings.*

##### 4.4.1 System Data

The system configuration is set in this menu.

You can access the menu via OSD and Java:



Figure 4-12. OSD and Java icons.

Select from the following settings:

Table 4-10. System data settings.

Field	Selection	Description
Device	Text	Enter the device name of the matrix (default: SWITCH 01)
Name	Text	Enter the name of the configuration that is used to save the current settings (default: Standard)
Info	Text	Additional text field to describe the configuration (default: Factory settings)
Slave	Activated	If the matrix is defined as a slave in the OSD, the user will lose control automatically. Use the keyboard command <Shift><Shift><s><o> to recover control. The OSD will open again in the matrix defined as slave.
	Deactivated	Function not active (default)
Auto Save	Activated	Save the current configuration of the matrix in the flash memory periodically.
	Deactivated	Function not active (default)
Enable COM echo	Activated	Send all performed switching commands in the matrix as an echo via serial interface. <i>NOTE: Enable this function when using media control via the serial interface.</i>
	Deactivated	Function not active (default)
Enable LAN echo	Activated	Send all performed switching commands in the matrix as an echo via LAN connection. <i>NOTE: Enable this function when using media control via the serial interface.</i>
	Deactivated	Function not active (default)
Synchronize	Activated	Synchronize the slave matrix according to the switch status of the master matrix.
	Deactivated	Function not active (default)
Master IP address	Numerical value	Set the network address of the master matrix (default value: 000.000.000.000)



OSD

Select Configuration > System in the main menu.

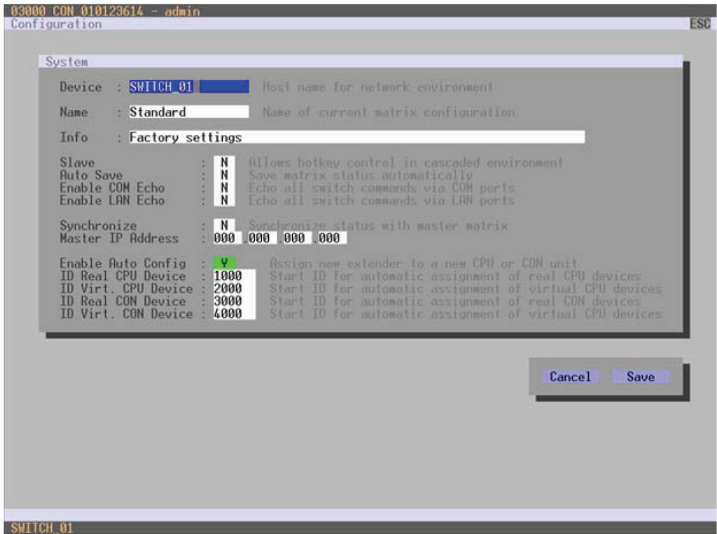

Figure 4-13. Menu Configuration—System screen.

Table 4-11. Cancel and Save selection buttons.

Button	Function
Cancel	Reject changes
Save	Save changes

## Java Tool

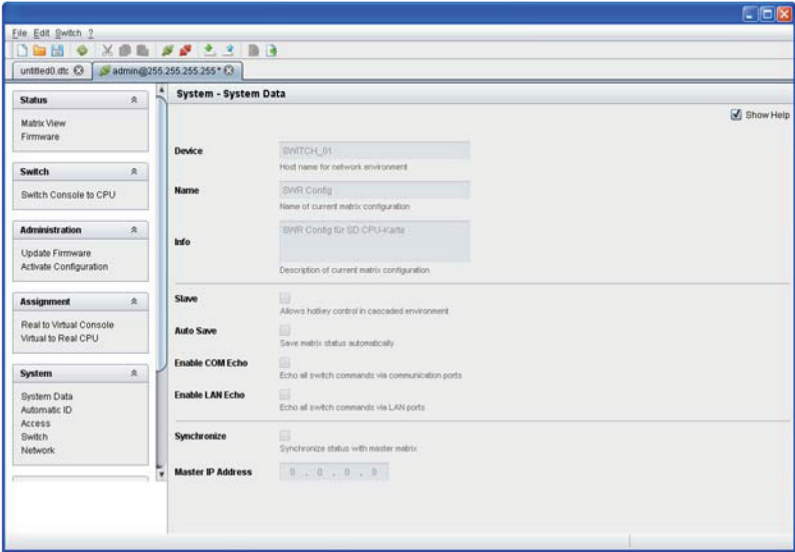

Figure 4-14. Menu System—System Data.

### 4.4.2 Automatic ID

From this menu, you can automatically create CPU and CON devices' settings by connecting a new extender unit.

You can access the menu via OSD or Java:



Figure 4-15. OSD and Java icons.

You can select between the following settings:

Table 4-12. Automatic ID settings.

Field	Selection	Description
Enable Auto Config	Activated	Automatically creates a new CPU or CON device if new extender units are connected (default)
	Deactivated	Function not active
ID Real CPU Device	Numerical value	Initial value of the automatic ID for real CPUs (default value: 1000)
ID Virtual CPU Device	Numerical value	Initial value of the automatic ID for virtual CPUs (default value: 2000)
ID Real CON Device	Numerical value	Initial value of the automatic ID for real CONs (default value: 3000)
ID Virtual CON Device	Numerical value	Initial value of the automatic ID for virtual CONs (default value: 4000)

OSD

Select Configuration > System in the main menu.

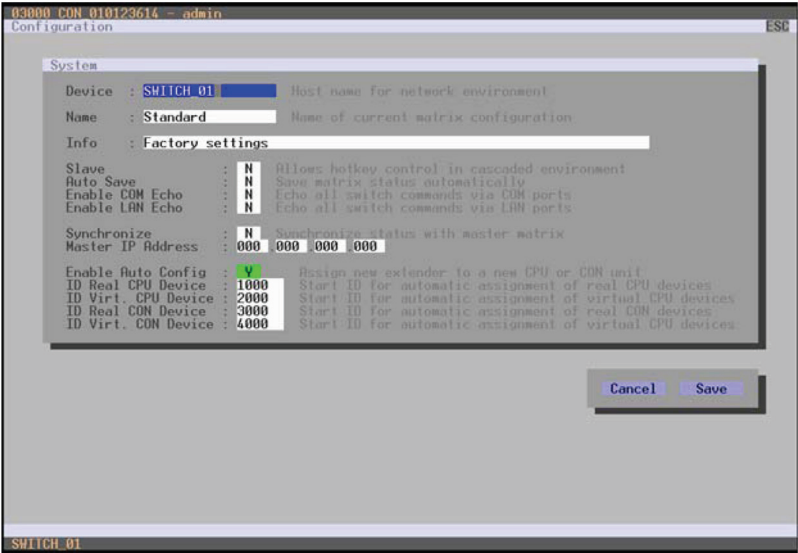

Figure 4-16. Menu Configuration—System screen.

Table 4-13. Cancel and Save selection buttons.

Button	Function
Cancel	Reject changes
Save	Save changes

### Java Tool

Select “System > Automatic ID” in the task area.

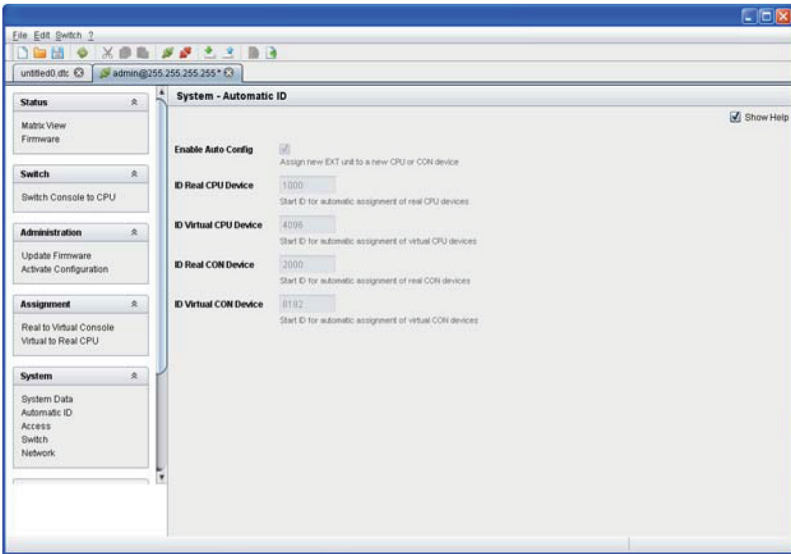

Figure 4-17. Menu System—Automatic ID screen.

### 4.4.3 Access

The access configuration is set in this menu.

You have the following possibilities to access the menu:



Figure 4-18. OSD and Java icons.

Table 4-14. Access settings.

Field	Selection	Description
Enable User Login	Activated	The user has to log in with a user name and a password code to enter OSD. Thereafter, the user remains logged in until he explicitly logs out or an auto logout is effected.
	Deactivated	Function not active (default)
Enable User ACL	Activated	CPU access is restricted according to the permissions in the ACL (Access Control List). <ul style="list-style-type: none"> <li>• User login is required.</li> <li>• Switching by keyboard hotkeys requires a prior login.</li> </ul>
	Deactivated	Function not active (default)
Auto Disconnect	Activated	Upon opening the OSD, the console will automatically disconnect from the current CPU.
	Deactivated	Function not active (default)
OSD Timeout	0–999 seconds	Period of inactivity after which OSD will close automatically. <ul style="list-style-type: none"> <li>• Select 0 seconds, for no timeout (default: 0 seconds)</li> </ul>
Auto Logout	0–999 minutes	Period of inactivity after which a user is automatically logged out from the OSD at this console. <ul style="list-style-type: none"> <li>• The timer is not active as long as the OSD is open.</li> <li>• Select 0 minutes, for no timeout (default: 0 minutes)</li> </ul>

## OSD

Select Configuration > Access in the main menu.

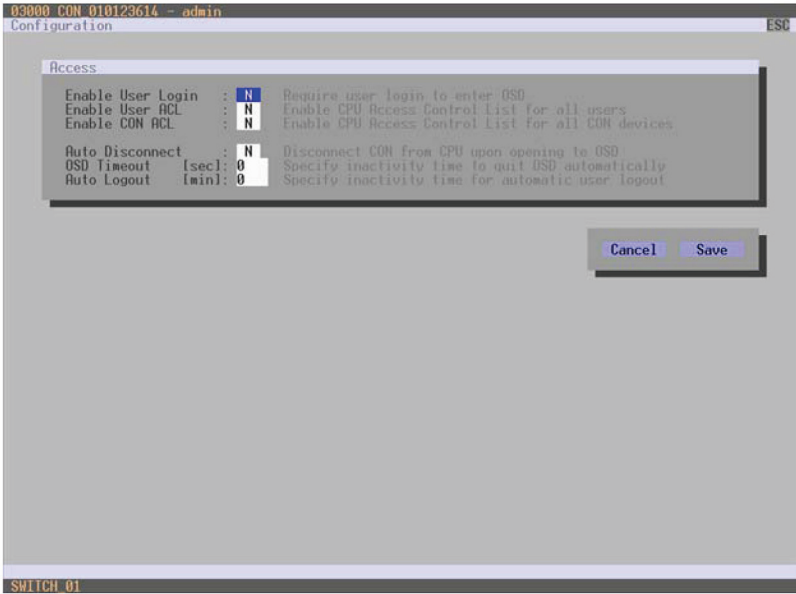

Figure 4-19. Menu Configuration Access screen.

You can select between the following buttons:

Table 4-15. Cancel and Save selection buttons.

Button	Function
Cancel	Reject changes
Save	Save changes

## Java Tool

Select System > Access in the task area.

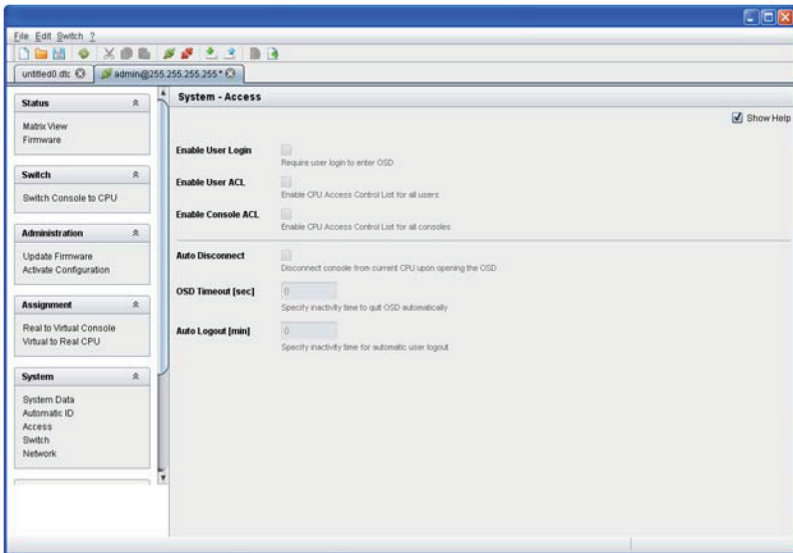

Figure 4-20. Menu System—Access screen.

### 4.4.4 Switch

The configuration of the switching parameters is set in this menu.

You have the following possibilities to access the menu:



Figure 4-21. OSD and Java icons.

# Chapter 4: Configuration

You can select between the following settings:

Table 4-16. Switch settings.

Field	Selection	Description
Video Sharing	Activated	The user can switch to any CPU as an observer, even to ones that are already assigned to another user (observer without keyboard/mouse access). <ul style="list-style-type: none"><li>• <i>NOTE: Switch with the &lt;Space&gt; key , not the &lt;Enter&gt; key.</i></li><li>• The operator will not be informed if further users connect as an observer to the CPU that is connected to his console.</li></ul>
	Deactivated	Function not active (default)
Force Connect	Activated	The user can connect to every single CPU as an operator, even to ones that are related to another user. <ul style="list-style-type: none"><li>• <i>NOTE: The previous user is set to video-only status.</i></li><li>• To share K/M control, Force Connect must be activated.</li></ul>
	Deactivated	Function not active (default)
Force Disconnect	Activated	Extension of Force Connect: If the user connects to a CPU as an operator that is already related to another user, the connection to the previous user will be completely disconnected. <i>NOTE: To share K/M control, Force Connect must be deactivated.</i>
	Deactivated	Function not active (default)
CPU Auto Connect	Activated	If a console is not connected to a CPU, you can establish an automatic connection to the next available CPU by pressing any key or mouse button.
	Deactivated	Function not active (default)
CPU Timeout	0–999 minutes	Period of inactivity after which a console will automatically disconnect from its current CPU. (default value = 0 minutes)
Keyboard Connect	Activated	Activate request of K/M control by keyboard event (key will be lost)
	Deactivated	Function not active (default)
Mouse Connect	Activated	Activate request of K/M control by mouse event
	Deactivated	Function not active (default)



Table 4-16 (continued). Switch settings.

Field	Selection	Description
Release Time	0–999 seconds	<p>Period of inactivity of a connected console after which K/M control can be requested by other consoles connected to the CPU.</p> <ul style="list-style-type: none"><li>• <i>NOTE: Set "0" for an immediate transfer in real time.</i></li><li>• Only one console can have keyboard and mouse control at the same time. The other consoles that are connected to the same CPU have a video-only status (default value: 10 seconds)</li></ul>

*NOTE: If the options Keyboard Connect and/or Mouse Connect are activated, the Release Time condition must be met until a new user gains control.*

**OSD**

Select Configuration > Switch in the main menu.

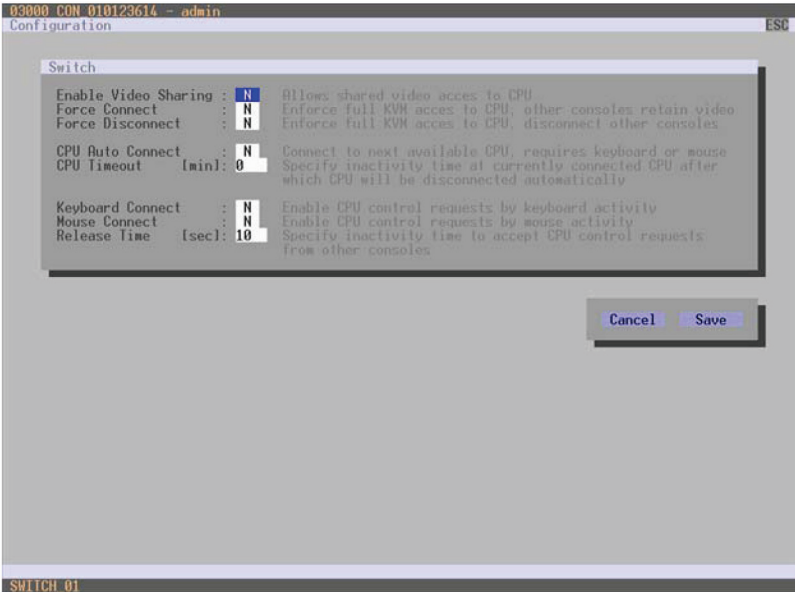

Figure 4-22. Menu configuration–System.

Table 4-17. Cancel and Save selection buttons.

Button	Function
Cancel	Reject changes
Save	Save changes

### Java Tool

Select “System > Switch” in the task area.

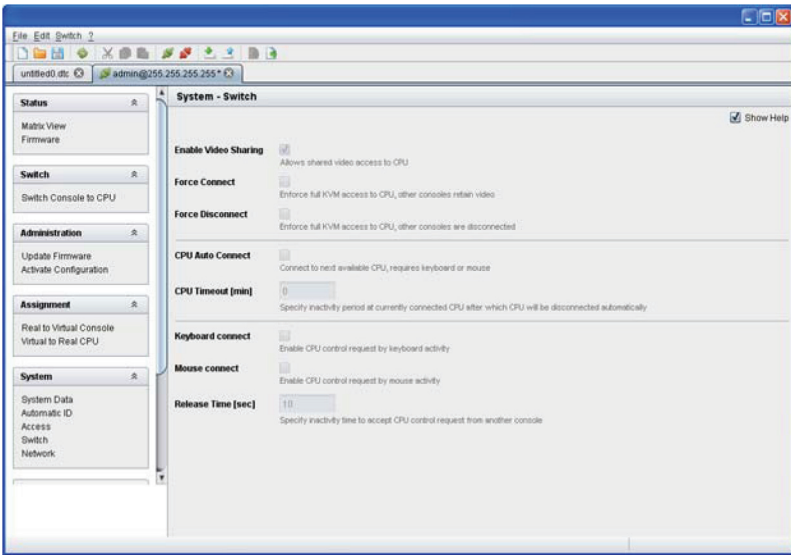

Figure 4-23. Menu system—switch.

### 4.4.5 Network

The network configuration is set in this menu.

You have the following possibilities to access the menu:



Figure 4-24. OSD and Java icons.

Table 4-18. Network settings.

Field	Selection	Description
DHCP	Activated	The network settings are automatically supplied by a DNS server (default)
	Deactivated	Function not active
IP address	Byte	Input of the IP address in the form "192.168.1.1," if DHCP is not active
Subnet Mask	Byte	Input of the subnet mask in the form "255.255.255.0," if DHCP is not active (default 255.255.255.0)
Gateway	Byte	Input of the subnet mask in the form "192.168.1.1," if DHCP is not active

*NOTE: To activate the modified network parameters, restart the ServSwitch DKM.*

*CAUTION: Consult your system administrator before modifying the network parameters. Otherwise, unexpected results and failures can occur in combination with the network.*

**OSD**

Select "Configuration > Network" in the main menu.

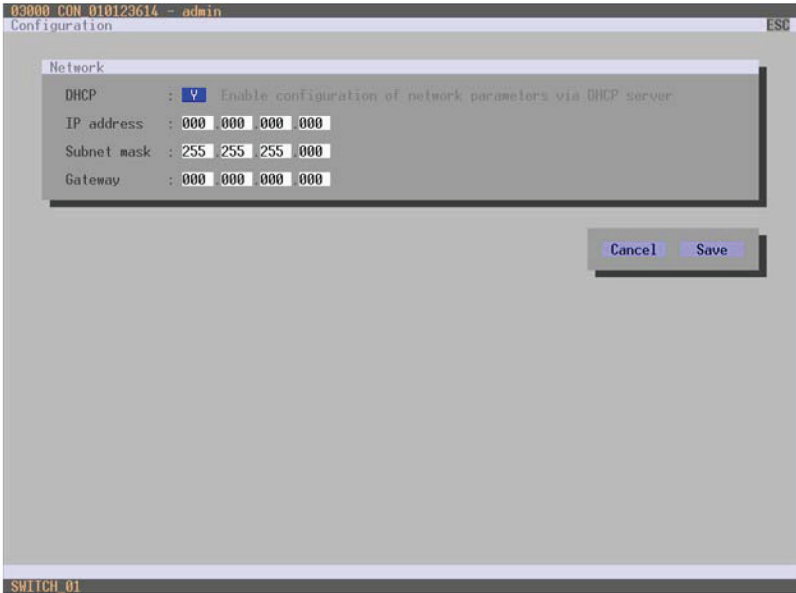

Figure 4-25. Menu Configuration—Network screen.

Table 4-19. Cancel and Save selection buttons.

Button	Function
Cancel	Reject changes
Save	Save changes

### Java Tool

Select System > Network in the task area.

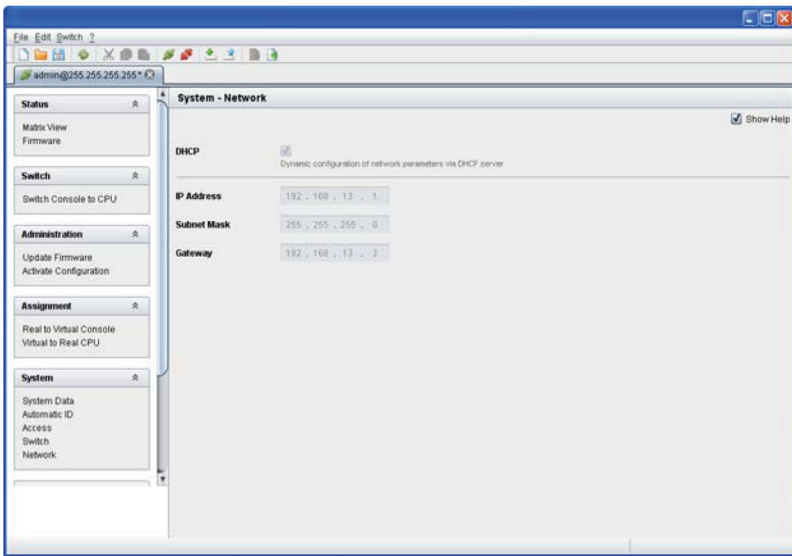

Figure 4-26. Menu system—network.

### 4.4.6 Date and Time

Date and Time are set in this menu.

You can access the menu via OSD:



Figure 4-27. OSD icon.

Table 4-20. Date and time settings.

Field	Selection	Description
Month	1–12	Enter month
Date	1–31	Enter date
Year	1–99	Enter year
Day of the week	1–7	Enter week
Hours	0–23	Enter hour
Minutes	0–59	Enter minute
Seconds	0–59	Enter second

## OSD

Select “Configuration > Date+Time” in the main menu.

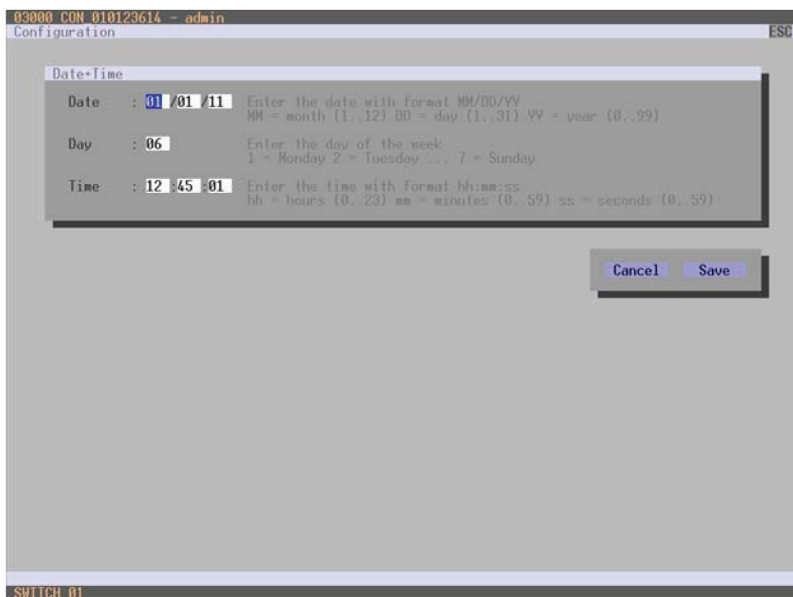

Figure 4-28. Menu Configuration—Date and Time screen.

# Chapter 4: Configuration

---

You can select between the following buttons:

Table 4-21. Cancel and Save selection buttons.

Button	Function
Cancel	Reject changes
Save	Save changes

## 4.5 User Settings

You have the possibility to configure the following user settings:

### User Data

New users and their user settings and permissions are set in this menu.

You have the following possibilities to access the menu:



Figure 4-29. OSD and Java icons.

You can select between the following settings:

Table 4-22. User data settings.

Field	Selection	Description
Name	Text	User name (case-sensitive)
Password	Text	User password (case-sensitive)
Repeat Password	Text	Repeat user password (case-sensitive)
HTTP	Activated	Access permission via HTTP
	Deactivated	Function not active (default)
FTP	Activated	Access permission via FTP. This setting is necessary for file access from the Java tool or any Web browser.
	Deactivated	Function not active (default)

Table 4-22 (continued). User data settings.

Field	Selection	Description
TEL	activated	Access permission via Telnet
	deactivated	Function not active (default)
POW	activated	<ul style="list-style-type: none"><li>• User has rights</li><li>• Permission for crosspoint operations</li></ul>
	deactivated	Function not active (default)
ADM	activated	<ul style="list-style-type: none"><li>• Permission for system configuration and all switching operations</li><li>• User has administrator rights</li><li>• This setting is required for an online connection with the Java tool</li></ul>
	deactivated	Function not active (default)

OSD

Select "Configuration > User" in the main menu.

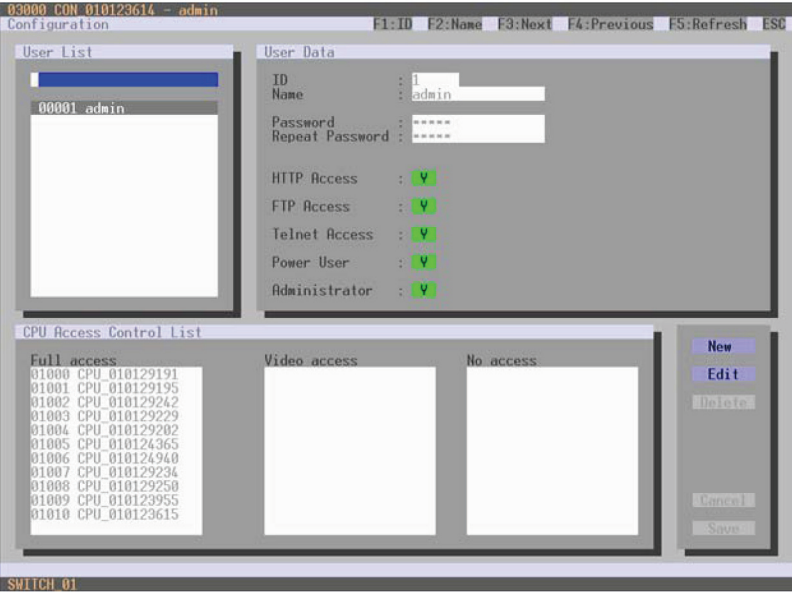

Figure 4-30. Menu Configuration—User screen.

Table 4-23. OSD settings.

Button	Function
New	Create a new user
Edit	Edit an existing user
Delete	Delete an existing user
Cancel	Reject changes
Save	Save changes

Java Tool

Select “User > User Data” in the task area.

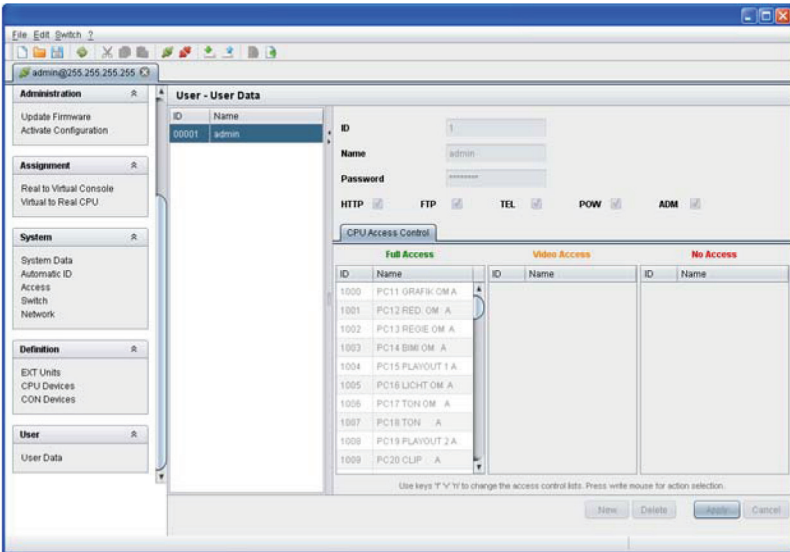

Figure 4-31. Menu User—User Data screen.

Table 4-24. OSD settings.

Button	Function
New	Create a new user
Delete	Delete an existing user
Apply	Create a new user account
Cancel	Reject changes



To configure user access rights for CPUs, proceed as follows:

1. Select a user in the User Data list.
2. By using the right mouse button once on a CPU in one of the respective access lists (Full Access, Video Access, and No Access), two lists for selection will appear in which the respective CPU can be moved and the access rights can be changed.
3. Confirm the configuration by pressing the “Apply” button.

To create a new user, proceed as follows:

1. Press the “New” button.
2. Select a template of an existing user if applicable (choose template).
3. Press the “OK” button.
4. Set password.
5. Set general access permissions.
6. Set user permissions for CPU access (paste function).
7. Set user favorites for OSD access.
8. Press the “Apply” button to save the new user settings.

You can select between the following keyboard commands:

Table 4-25. Keyboard commands.

Function	Keyboard Command
Add CPU to Full Access list	<F>
Add CPU to Video Access list	<V>
Add CPU to No Access list	<N>

### 4.6 Extender Settings

All extender units are managed in this menu. This also contains the creation of new extender units and the deletion of existing extender units.

The extender unit describes the connection of a physical extender to the matrix. Every extender board with a direct cable connection to the matrix is recognized as an extender unit. Dual-head KVM extenders will be recognized as two independent extender units.

*NOTE: KVM extenders automatically create extender units inside the matrix.*

## Chapter 4: Configuration

---

To access the menu, use OSD or Java:



Figure 4-32. OSD and Java icons.

Table 4-26. OSD settings.

Field	Selection	Description
ID	Text	Numerical value of the extender ID (KVM extenders: ID is provided by extender unit [serial no.] and cannot be changed)
Name	Text	Name of the extender unit
Fixed	Activated	Create an extender unit with a fixed port assignment (default)
	Deactivated	Function not active (default)
Port	1–288 (depending on the matrix)	Port number of the extender unit

OSD

Select "Configuration > EXT Units" in the main menu.

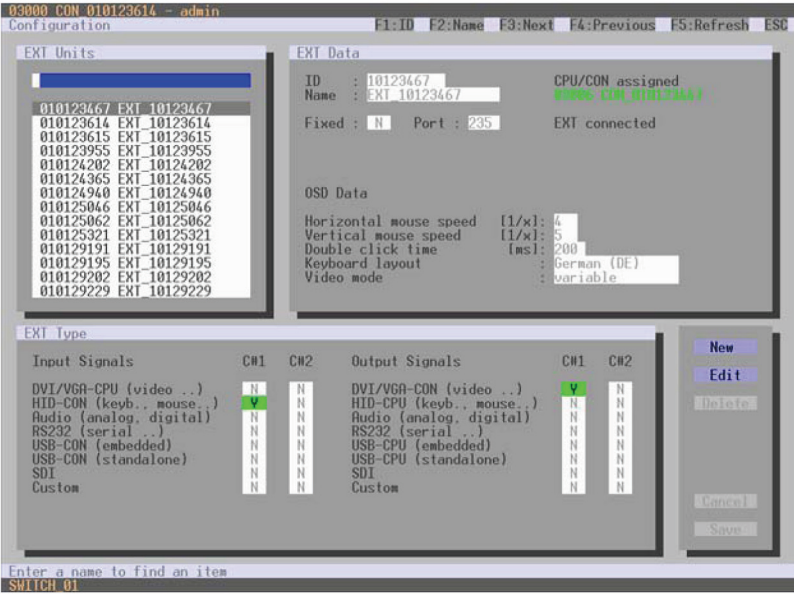

Figure 4-33. Menu Configuration—EXT Units screen.

You can select between the following buttons:

Table 4-27. Extender (EXT) units settings.

Button	Function
New	Create an extender unit
Edit	Edit an existing extender unit
Delete	Delete an existing extender unit
Cancel	Reject changes
Save	Save changes

# Chapter 4: Configuration

The settings for the tab OSD Data are described in Section 4.8.2.

## Java Tool

Select “Definition > EXT Units” in the task area.

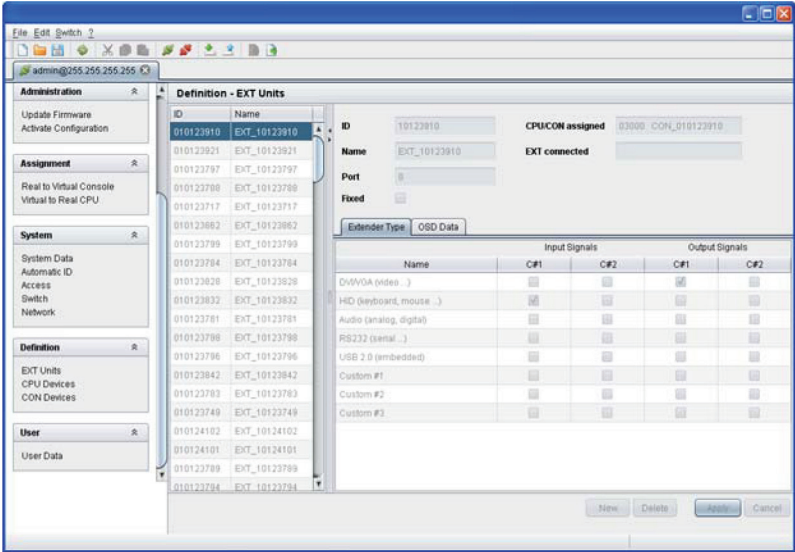

Figure 4-34. Menu Definition—EXT Units screen.

You can select between the following buttons:

Table 4-28. OSD settings.

Button	Function
New	Create a new extender unit
Delete	Delete an existing unit
Apply	Confirm changes of an extender unit
Cancel	Reject changes

1. To create a new extender unit press the button “New.”
2. Select whether a template of an existing extender unit (“Choose extender as template”), a template of an predefined extender type (“Choose extender type”) or no template (“None”) should be used.
3. Press the “OK” button.
4. Set all relevant parameters for the extender unit.
5. Press the “Apply” button to save the new extender unit.

*CAUTION: Created extender units are always set as fixed port extenders. These configurations are necessary, if you want to switch, for example, USB 2.0 connections via the matrix.*

### 4.7 CPU Settings

New CPU devices are configured in this menu including their assignment to extenders.

The assignment helps to describe and switch more complex computer configurations (for example, Quad-Head with USB 2.0) in the matrix.

You can access the menu via the OSD or Java icon:



Figure 4-35. OSD and Java icons.

You can select between the following settings:

Table 4-29. CPU settings.

Field	Selection	Description
ID	Text	ID of the CPU unit (see Section 4.4.2)
Name	Text	Name of the CPU device
Fixed	Activated	Create new CPU device as a virtual one
	Deactivated	Function not active (default)

## OSD

Select “Configuration > CPU Units” in the main menu.

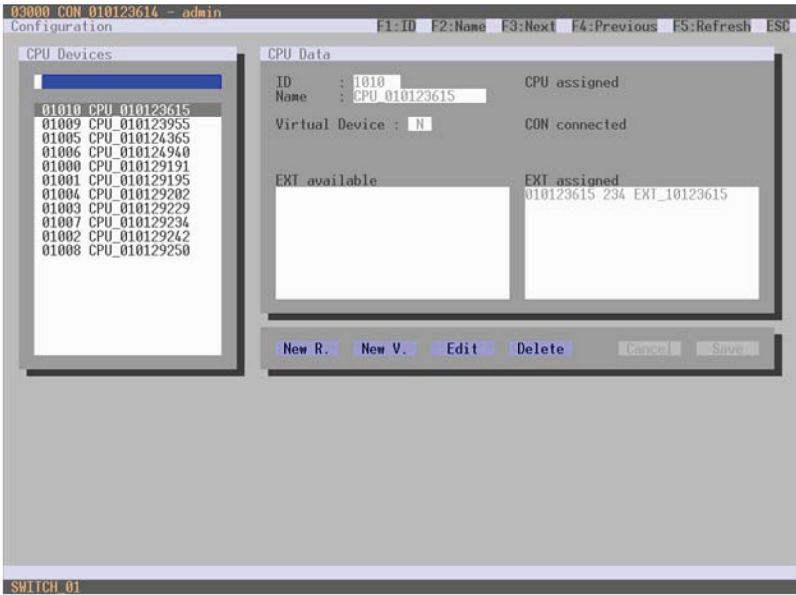

Figure 4-36. Menu Configuration—CPU Devices screen.

You can select between the following buttons:

Table 4-30. CPU unit buttons.

Button	Function
New R.	Create a new real CPU unit
New V.	Create a new virtual CPU unit
Edit	Edit an existing CPU device
Delete	Delete an existing CPU device
Cancel	Reject changes
Save	Save changes

## Java Tool

Select “Definition > CPU Devices” in the task area.

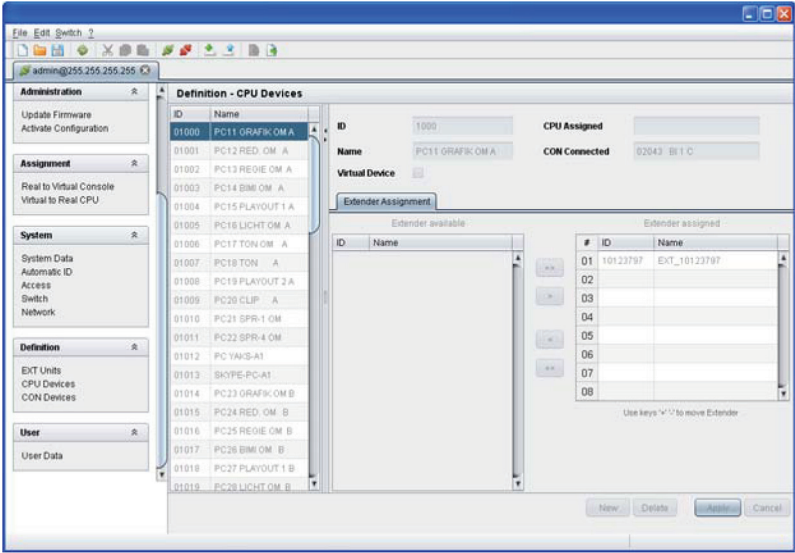

Figure 4-37. Menu Definition—CPU Devices screen.

You can select between the following buttons:

Table 4-31. CPU devices buttons.

Button	Function
New	Create a new CPU device
Delete	Delete a new CPU device
Apply	Confirm a created CPU device
Cancel	Reject changes
>	Assign selected extender units
>>	Assign all available extender units
<	Remove the selected extender units
<<	Remove all extender units

You can select between the following keyboard commands:

Table 4-32. Keyboard commands.

Function	Keyboard Command
Change assignment number of the extender unit upwards	<+>
Change assignment number of the extender unit downwards	<->

## Chapter 4: Configuration

---

To create a new CPU device, proceed as follows:

1. Press the "New" button.
2. Select whether a real CPU ("Create a real CPU") or a virtual CPU ("Create a virtual CPU") should be created or a template of an existing CPU should be used ("Choose template").

*NOTE: A template can be used only if there is at least one existing CPU device.*

3. Press the "OK" button.
4. Determine all parameters that are relevant for the CPU.
5. To confirm the new CPU, press the "Apply" button.

To access a new CPU via matrix, an assignment of one or more CPU type extender units is required. Proceed as follows:

1. Select the new CPU in the CPU devices list.
2. Select one or more extenders in the Extender available list.
3. Perform the assignment by pressing the ">" button. To assign all available extenders to the CPU, press the ">>" button.

The assignments are displayed in the Extender assigned list.

4. Confirm the assignment by pressing the "Apply" button.

To remove an extender assignment, proceed as follows:

1. Select a CPU in the CPU Devices list.
2. Select one or more extenders in the Extender assigned list.
3. Remove the assignment with the button <. To remove all existing assignments, press the button <<.
4. Confirm the removal with the "Apply" button.

### 4.8 Console Settings

You can perform the following console settings:

#### 4.8.1 CON Devices

New CON devices are created in this menu including access rights and assignment to extenders.



You can access the menu via OSD or Java:



Figure 4-38. OSD and Java icons.

You can select between the following settings:

Table 4-39. CON devices settings.

Field	Selection	Description
ID	Text	ID of the CON unit (see Section 4.4.2)
Name	Text	Name of the CON device
Virtual device	Activated	Create new CON device as a virtual one
	Deactivated	Function not active (default)
Allow login	Activated	Allow user login at this CON device
	Deactivated	Function not active
Force login	Activated	Force user login at this CON device
	Deactivated	Function not active

OSD

Select “Configuration > CON Devices” in the main menu.

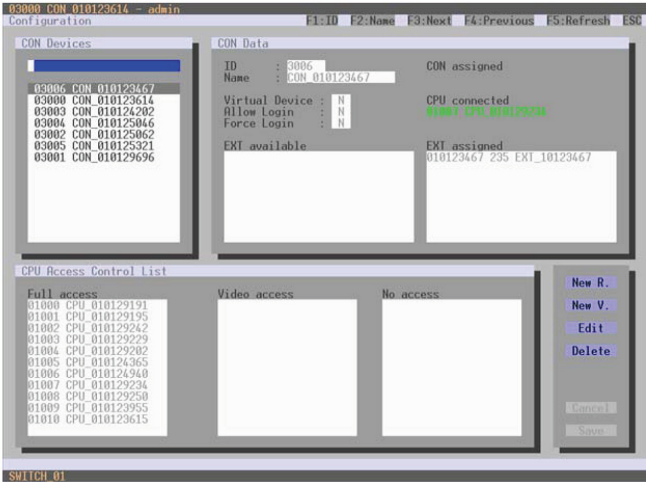

Figure 4-39. Menu Configuration—CON Devices screen.

# Chapter 4: Configuration

You can select between the following buttons:

Table 4-34. CON devices buttons.

Button	Function
New R.	Create a real console
New V.	Create a virtual console
Edit	Edit an existing console
Delete	Delete an existing console
Cancel	Reject changes
Save	Save changes

## Java Tool

Select “Definition > CON Devices” in the task area.

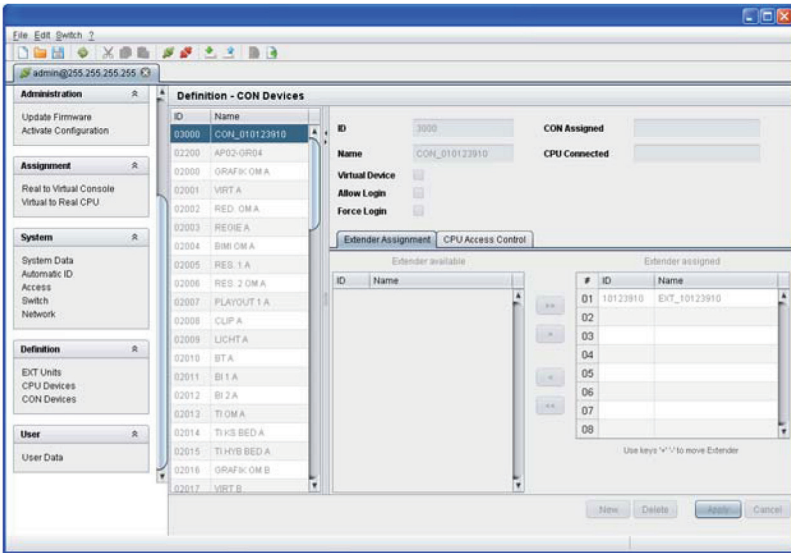

Figure 4-40. Menu Configuration—CON Devices screen.

Table 4-35. Menu configuration—  
CON devices buttons.

Button	Function
New	Open a new CON device
Delete	Delete a new CON device
Apply	Confirm a created CON device
Cancel	Reject changes
>	Assign selected extender units
>>	Assign all available extender units
<	Remove the selected extender units
<<	Remove all extender units

You can select between the following keyboard commands:

Table 4-36. Keyboard commands.

Function	Keyboard Command
Decrease assignment number of the extender unit	<+>
Increase assignment number of the extender unit	<->

To create a new console, proceed as follows:

1. Press the “New” button.
2. Select “Create a real Console” to create a real console or a select “Create a virtual Console” to create a virtual console, or select “Choose template” to use the template of an existing console.
3. Press the “OK” button.
4. Determine all parameters that are relevant for the console.
5. To confirm a created console, press the “Apply” button.

To run a created CPU via matrix, you need to assign one or more CON units (extenders). To place an assignment, proceed as follows:

1. Select the console in the CON devices list to be assigned to an extender.
2. Select the extender in the Extender available list to be assigned to the CON.
3. Perform the assignment by pressing the “>” button. To assign all available extenders to the console, press the “>>” button. The assignments are displayed in the Extender assigned list.

## Chapter 4: Configuration

---

4. Confirm the assignment by pressing the “Apply” button.

To remove an extender assignment, proceed as follows:

1. Select the console in the CON devices to be modified list.
2. Select the extender(s) in the Extender assigned to be removed list.
3. Remove the assignment with the “<” button. To remove all existing assignments, press the “<<” button.
4. Confirm the changes by pressing the “Apply” button.

To configure the access rights of consoles to CPUs, proceed as follows:

1. Select a console in the CON devices list.
2. Open the “CPU Access Control” tab.
3. Assign new access rights by using the right mouse button or the respective keyboard commands (see below).
4. Confirm the configuration by pressing the “Apply” button.

*NOTE: Once created, a new user automatically receives full access to all available CPUs.*

You can select between the following keyboard commands:

Table 4-37. Keyboard commands.

Function	Keyboard Command
Add CPU to Full Access list	<F>
Add CPU to Video Access list	<V>
Add CPU to No Access list	<N>

### 4.8.2 Mouse and Keyboard

From this menu, you can set the OSD configuration for mouse and keyboard. You can access the menu via OSD or Java.



Figure 4-41. OSD and Java icons.

Table 4-38. Mouse and keyboard settings.

Field	Selection	Description
Horizontal speed 1/x	1–9	Adjusts the horizontal mouse speed: 1= slow, 9 = fast (default value = 4)
Vertical speed 1/x	1–9	Adjusts the vertical mouse speed: 1= slow, 9 = fast (default value = 5)
Double-click	100–800	Adjusts the time slot for a double-click (default value = 200 ms)
Keyboard layout	Region	Set the OSD keyboard layout according to the keyboard you are using (default: German [DE])
Video mode	Variable or specific resolution	Resolution that is used when opening OSD

*NOTE: The mouse and keyboard settings are console specific. You can set them separately for every console.*

**OSD**

Select “Configuration > EXT Units” in the main menu.

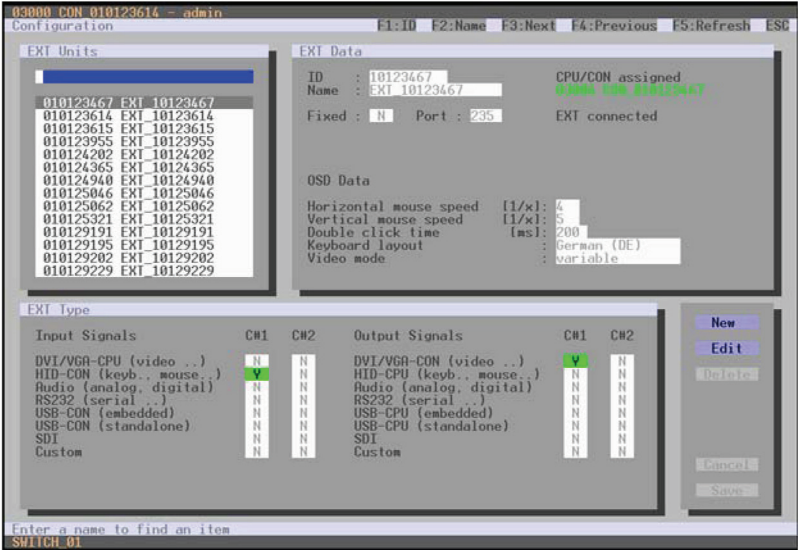

Figure 4-42. Menu Configuration—EXT Units screen.

You can select between the following buttons:

Table 4-39. Buttons.

Button	Function
Cancel	Reject changes
Save	Save changes

## Java Tool

Select “Definition > EXT Units” in the task area.

*NOTE: Set mouse and keyboard settings using the OSD Data tab.*

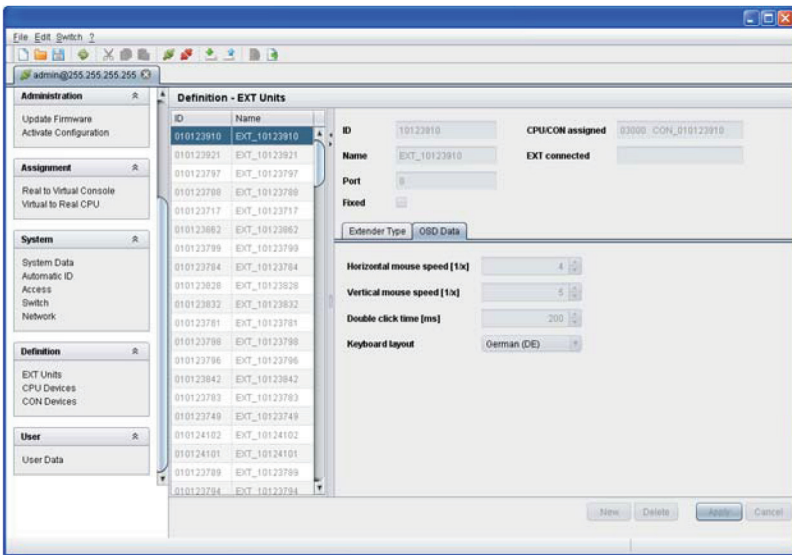

Figure 4-43. Menu Definition—EXT Units screen.

## 4.9 Saving and Loading Configurations

You can set the following configurations:

### 4.9.1 Active Configuration

Use the OSD button to access the menu:



Figure 4-44. OSD button.

Select “Configuration > Save” in the main menu.

By selecting this menu item, the active configuration of the matrix is saved to the permanent matrix memory. By default, the last configuration that has been saved in this way will be restored after the matrix restarts.

*NOTE: Changing or saving configurations blocks the matrix memory and freezes all OSD menus for a few seconds. The switching connections are not affected by this freeze.*

If you select “Auto Save” within the system settings, it will automatically save the configuration periodically.

### 4.9.2 Saving Configurations (Internal)

In this menu, the current matrix configuration to predefined storage locations is saved. However, it does not replace configuration buffering.

You can access the menu via OSD or Java:



Figure 4-45. OSD and Java icons.

In Active, the name and detailed information of the current configuration are shown. This configuration can be saved now.

In Default and File #1 to File #8, the name and the detailed information of the respective saved configuration are shown. You can overwrite these storage locations.

The storage location to be overwritten by the current configuration must be selected explicitly.

Afterwards, the current configuration will be saved to this storage location and will be immediately shown in the menu. The previously saved configuration that was saved to this storage location is deleted.

### OSD

You can save the created configuration within eight storage locations in the matrix (File #1–File #8). You can also save a configuration as the default configuration.

1. Select “Configuration > Save As...” in the main menu.
2. Select the required storage location “(File #1–File #8)” or “Default.”

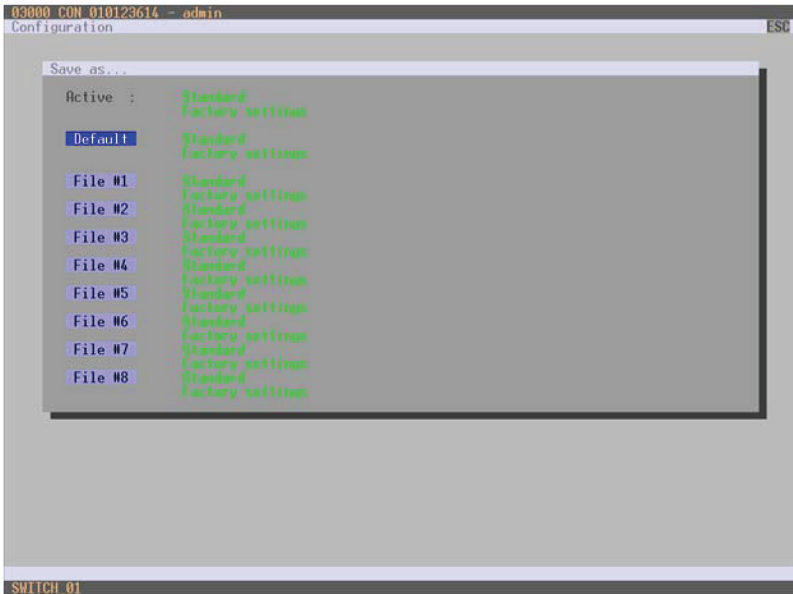

Figure 4-46. Menu Configuration—Save As screen.

### Java Tool

To save the configuration into the internal matrix memory, proceed as follows:

1. Select "File > Upload to..." in the menu bar.
2. Enter the IP address of the matrix, your user name, and your password, and select the storage location where the configuration will be saved (default or config01–config08).
3. Press the "OK" button to confirm.



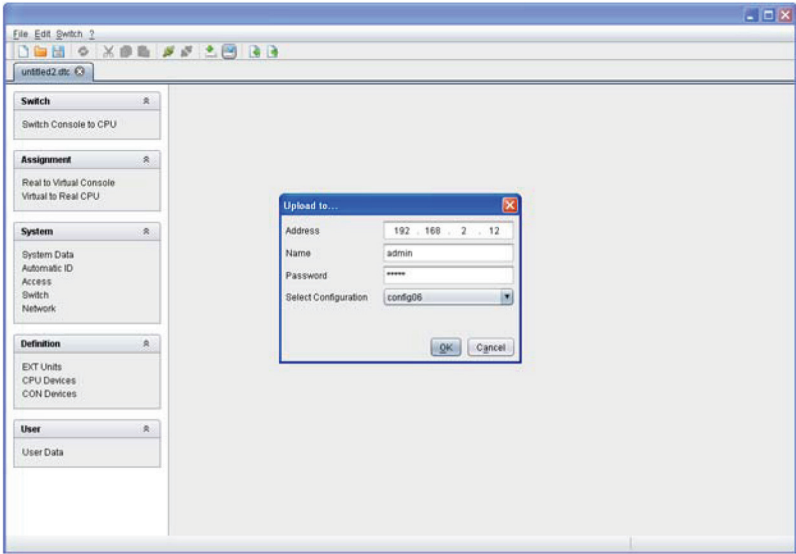

Figure 4-47. Menu File—Upload to screen.

### 4.9.3 Loading of Configurations (Internal)

Previously saved configurations are loaded in this menu.

You have the following possibilities to load configurations from files:



Figure 4-48. OSD and Java icons.

In Active, the currently loaded configuration is displayed.

In addition to the default configuration, you can load up to eight further configurations.

Select the configuration to be loaded from eight personalizable configurations and the default settings.

The selected configuration will be immediately loaded and displayed in the menu as “Active.” The previously active configuration is deleted.

## Chapter 4: Configuration

---

### OSD

1. Select “Configuration > Open” in the main menu.
2. Select the desired configuration.
3. Load the configuration by pressing the <Enter> key.

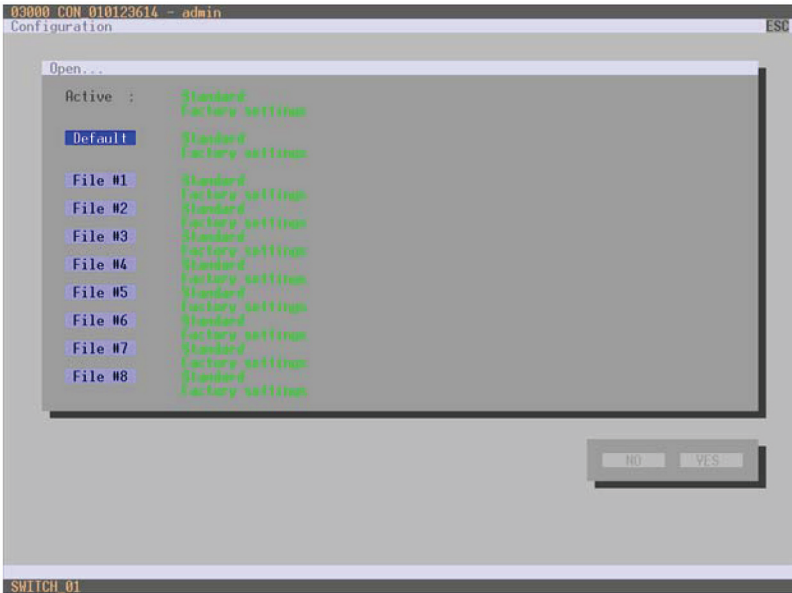

Figure 4-49. Menu Configuration—Open screen.

### Java Tool

1. Select “Administration > Activate Configuration” during on-line mode in the task area.
2. Select the required configuration.
3. Load the configuration by pressing the “Activate” button.

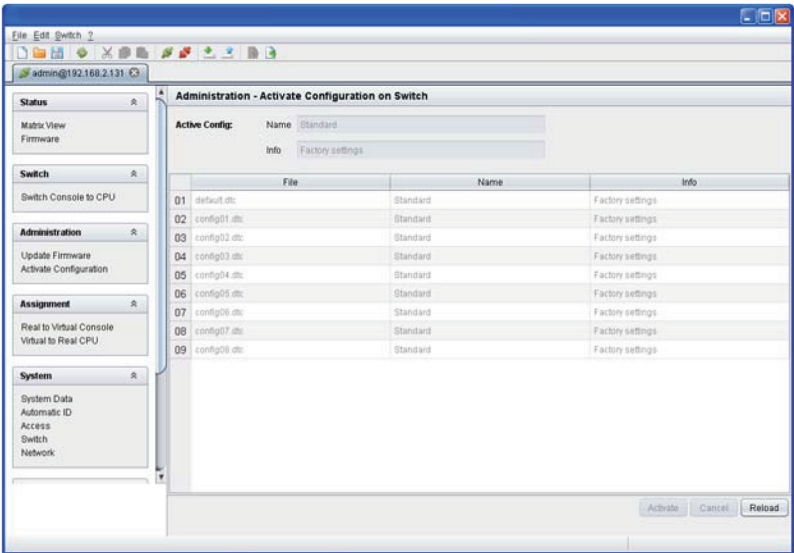

Figure 4-50. Menu Administration—Activate Configuration on Switch screen.

### 4.9.4 Saving Configurations (External)

You can save created configurations as a file, so that they will be independent of the matrix and transportable.

You have the following possibility to access the menu:



Figure 4-51. Java icon.

1. Select "File > Save As" in the menu bar.
2. Select the directory of the configuration on your storage medium where it will be saved.

*NOTE: Configurations are always saved in a file with the ending ".dtc."*

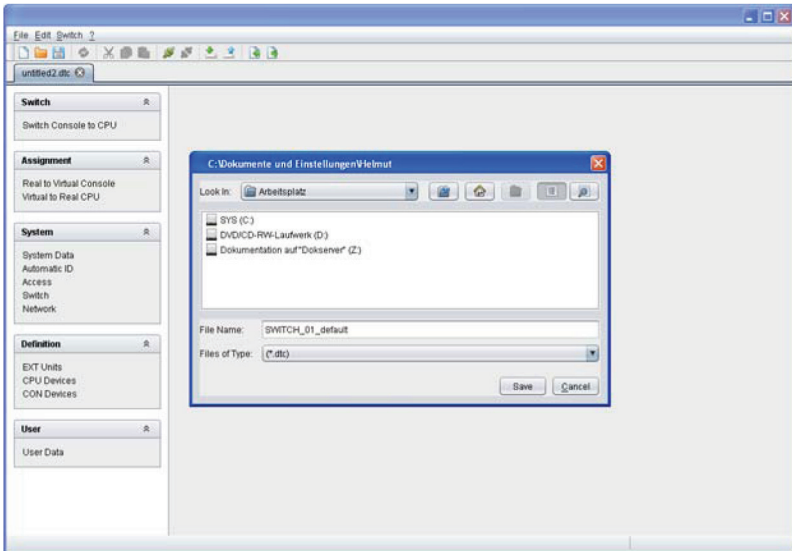

Figure 4-52. Menu File—Save As screen.

### 4.9.5 Loading Configurations (External)

Externally saved configurations are opened and activated in this menu.

You have the following possibilities to load configurations from files:

1. Select "File > Open..." during off-line mode and select the storage location of the configuration file that has to be opened.
2. Open the configuration by pressing the "Open" button.
3. Select "File > Upload to..." in the menu bar to transfer the opened configuration to the matrix. Enter the necessary parameters.
4. Select "Switch > Connect" in the menu bar to make a connection between the matrix and the Java tool. Enter the necessary parameters.
5. Select "Administration > Activate Configuration" and select the configuration to be activated.
6. Confirm the process with the "Activate" button.

The opened configuration is activated now and can be used.

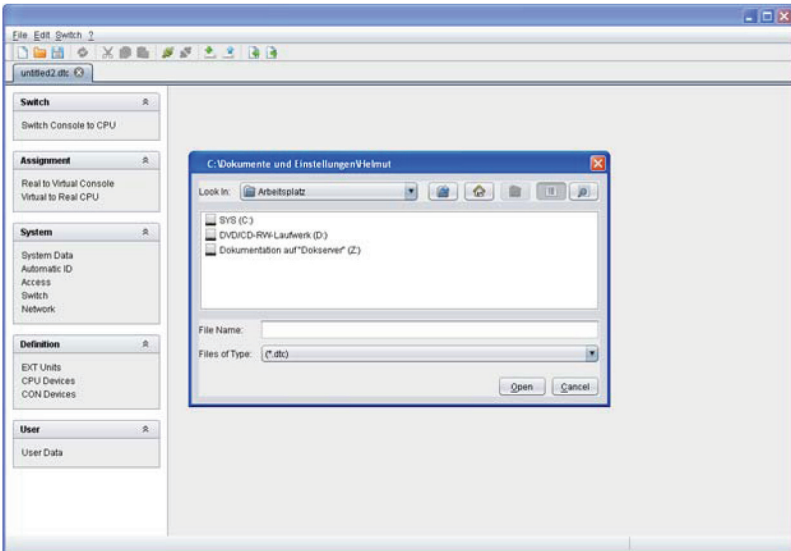

Figure 4-53. Menu File–Open screen.

#### 4.10 Export and Import Options

The ServSwitch DKM FX offers the possibility to read out available configuration lists (extender, CPUs, consoles and users) for exporting and importing again via Java tool. You have the following possibilities to handle configuration lists.

Exported configuration lists are always saved in “.csv” format that allows off-line editing with common spreadsheet applications.

You have the following possibilities to export or import configuration lists:



Figure 4-54. Java icon.

##### 4.10.1 Export Options

Configuration lists are exported in this menu. To export, proceed as follows:

1. Select “File > Export” in the menu bar.
2. After opening the menu, select the list to export (Extender, CPU, Console or User).

3. Select the storage location for the export file.
4. Confirm the export with the “Finish” button.

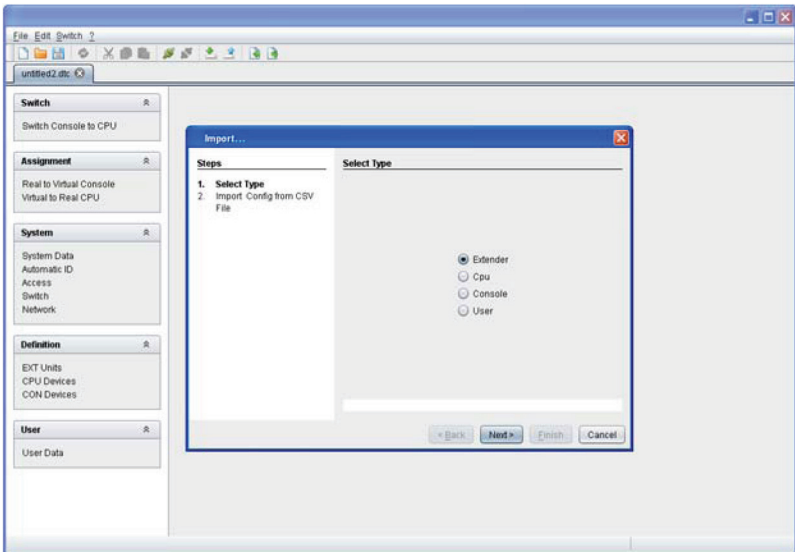

Figure 4-55. Menu File–Export screen.

### 4.10.2 Import Options

Configuration lists are imported in this menu. To import, proceed as follows:

1. Select “File > Import” in the menu bar.
2. After opening the menu, select the list to import (Extender, CPU, Console or User).
3. Select the directory of the list to import.
4. Confirm the import with the “Finish” button.

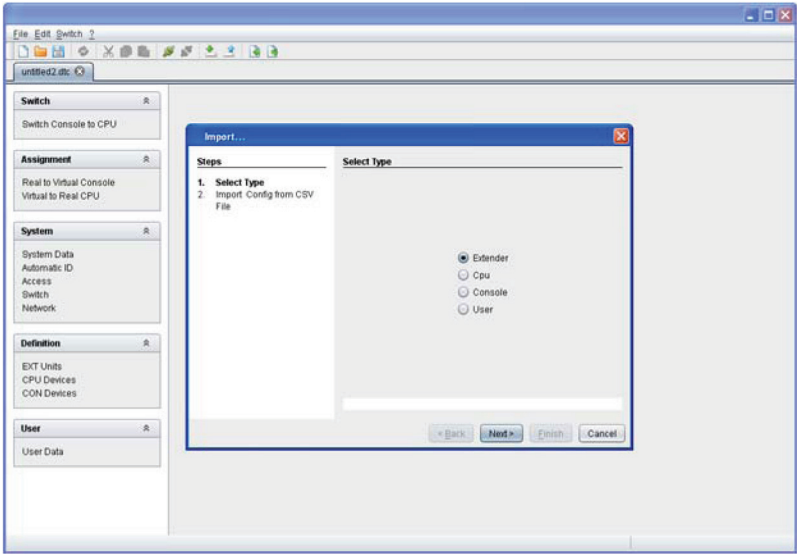

Figure 4-56. Menu File–Import screen.

### 4.11 Firmware Update

The firmware of the matrix can be updated in this menu.

To access the menu, use the Java icon:



Figure 4-57. Java icon.

1. Select “Administration > Update Firmware” in the task area.

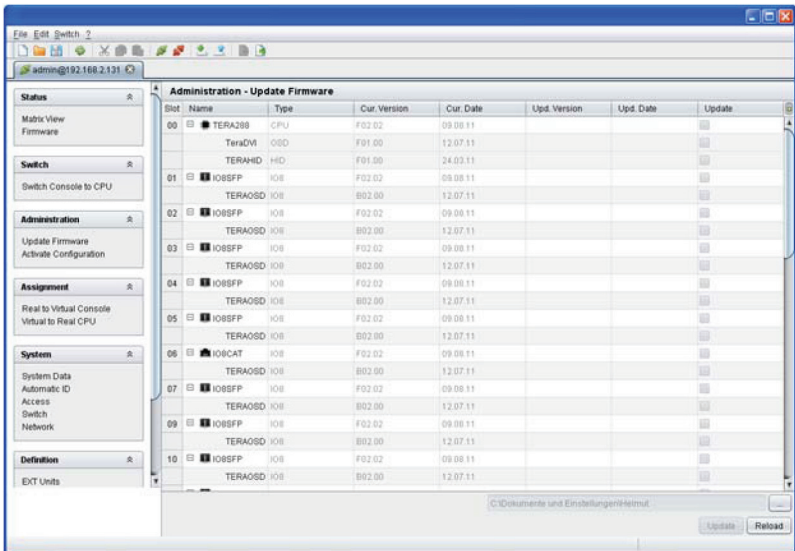

Figure 4-58. Menu Administration–Update Firmware screen.

2. Select the directory in the lower part of the working area in which the update files can be found.
3. Select those modules in the list that have to be updated and enable the respective checkbox in the Update column.
4. Start the update by pressing the “Update” button in the lower part of the working area.
5. Restart the matrix by pressing the “Restart matrix” button in the lower part of the working area.



### 5. Operation

You can operate the ServSwitch DKM FX in three different ways:

#### 1. Direct Switching

- via a keyboard connected to a CON port and the hotkeys
- by a macro keyboard connected to a console port

#### 2. OSD

- via keyboard/mouse directly connected to the CPU board of the matrix
- via keyboard/mouse connected to a CON Unit and the OSD

#### 3. External Switching Commands:

- via an external computer via Java tool (network connection required)
- via a media control (network or serial connection required)

### 5.1 Operation via Hotkeys

#### 5.1.1 Direct Switching

The direct switching by hotkeys on a keyboard is the fastest way for a user to switch at his console between different CPUs. He can switch video, keyboard and mouse, or only video.

#### Direct Switching of Video, Keyboard, and Mouse

1. Start Command Mode with the hotkey. For control, the LEDs Shift and Scroll flash at the keyboard, if Command Mode is activated.
2. Enter the index number of the new CPU from the list of favorites and confirm with <Enter>. At the same time, the Command Mode is closed and the console is connected to the new CPU with complete control.

*NOTE: For best switching time, use identical mice, keyboards, and monitors.*

*This contributes to a smooth and delayless direct switching of the matrix.*

#### Direct Switching of Video

1. Start Command Mode with the hotkey. For control, the LEDs Shift and Scroll flashes at the keyboard, if command mode is activated.
2. Enter the index number of the new CPU from the list of favorites and confirm with <Space>.

At the same time, the Command Mode is closed and the console is connected to the new CPU with video only.

## Chapter 5: Operation

---

*NOTE: You can only use the hotkeys to switch to unused and allowed CPUs. Hotkeys are only supported if neither "Enable User Login" nor "Enable User ACL" is selected and the user is logged in the OSD.*

### 5.1.2 Scan Mode

The Scan Mode can show video signals of the different CPUs fast and without delay and switch continuously using the hotkey. Switching between two video signals can even take place within one frame.

1. Start command mode with the hotkey. For control, the "Shift" and "Scroll" LEDs flash at the keyboard if command mode is activated.
2. Press the "<Left Shift>" key and hold it down. You can now enter the index numbers of the various CPUs from the list of favorites with the keyboard and immediately switch to the video signal of the respective CPU after entering the index number.
3. Leave Scan Mode by pressing "<Left Shift> + <Esc>."

*NOTE: For optimal results, use identical resolutions. This contributes to a smooth and delay-free scan mode function.*

### 5.1.3 Addressing Master and Slave

The ServSwitch DKM FX can be cascaded in two steps. You can optionally send the commands (including opening the OSD) to the master or the slave matrix.

Whenever command mode is activated, you can select by a <m> or a <s>, if all the following commands should be handled in the master or in the slave matrix.

#### OSD Access

- OSD access to the master matrix:  
<Left Shift>, <Left Shift>, <m> (optional), <o>
- OSD access to the slave matrix:  
<Left Shift>, <Left Shift>, <s>, <o>

Example: Switching to the CPU Port 23 of the slave matrix.

1. Switching to the CPU port (e.g. 12) of the master matrix that has the connection to the slave matrix:  
<Left Shift>, <Left Shift>, <m> (optional), <1>, <2>, <Enter>

2. Switching to the CPU Port 23 of the slave matrix:

<Left Shift>, <Left Shift>, <s>, <2>, <3>, <Enter>

*NOTE: The selected master/slave mode is permanently activated until another mode is manually activated. This means that if you select <s> for example, all prospective commands will be sent to the slave, but not if the Command Mode is left in the meantime.*

### 5.1.4 Function Keys <F1>–<F12>

In Command Mode you can retrieve the Macros 1–12 with the function keys <F1>–<F12> of the connected standard keyboard instead of the special macro keyboard.

The deposited command sequence for the appropriate function key is executed and Command Mode is left immediately.

By using <s> or <S> and <m> or <M> before you key in other commands, you can select whether the command sequence should be executed for the master or the slave.

*NOTE: The chosen control level remains selected only if the switch remains in Command Mode.*

### 5.2 KVM Switching

To switch using the ServSwitch DKM FX, use OSD or Java:



Figure 5-1. OSD and Java icons.

OSD

Select “Switch” in the main menu.

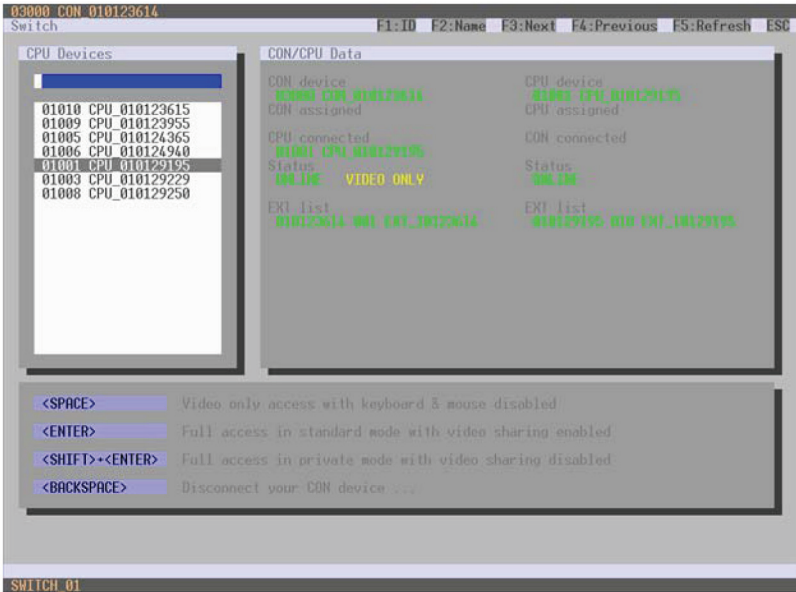

Figure 5-2. Menu Switch screen.

The following information is shown in this menu:

Table 5-1 Menu switch.

Field	Description
CON device	Assigned physical extender unit (CON unit)
CON assigned	Virtual CON device that is assigned to the real CON device
CPU connected	Currently connected CPU device
CON status	Current connection status (CON device)
EXT list	List of all available physical extender units (CON units)
CPU device	Assigned physical extender unit (CPU unit)
CPU assigned	Real CPU device that is assigned to a virtual CPU device
CON connected	Currentlty connected CON device
CPU status	Current connection status (CPU device)
EXT list	List of all available extender units (CPU units)

You can select from the following switching functions:

Table 5-2. Switching functions.

Function	Keyboard Command
Set a video-only connection	<Space>
Set a KVM connection	<Enter>
Set a KVM connection in private mode (video sharing disabled)	<Shift>+<Enter>
Disconnect own CON device from CPU device	<Backspace>

## Java Tool

Select “Switch > Switch Console to CPU” in the task area.

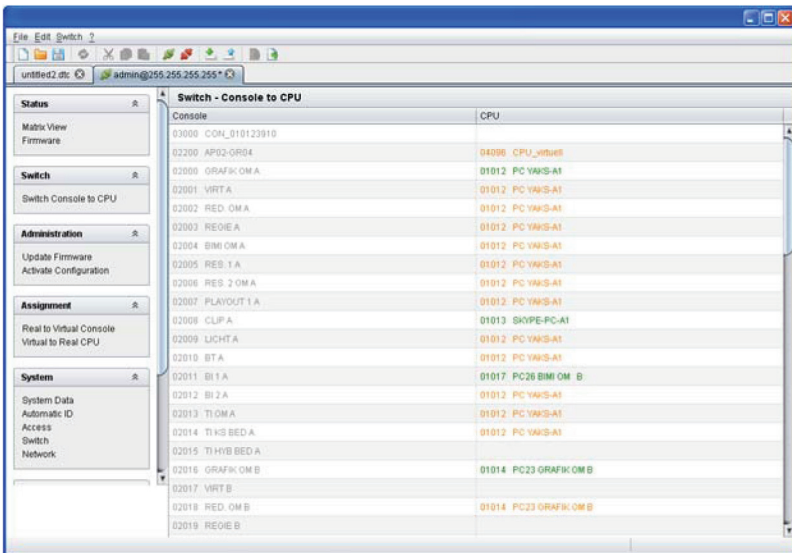

Figure 5-3. Menu Switch—Switch Console to CPU.

All connected consoles and the associated CPU connections are shown in columns in the working area in this menu.

*NOTE: Switching operations can only be performed in on-line mode, that means an active network connection between the matrix and the Java tool is needed.*

## Chapter 5: Operation

---

To set a KVM connection between a console and a CPU, double-click on the corresponding selection box within the CPU column and select the requested CPU (green).

To set a video connection between a console and a CPU, double-click on the corresponding selection box within the CPU column and select the requested CPU (orange).

*NOTE: CPUs whose respective console does not have access rights will not appear in the list.*

You can use the following button to perform a switching operation:

Table 5-3. Switching button.

Button	Function
Send	Send effected switching operations to the matrix

*NOTE: By activating the function Auto Send in the left lower corner of the working area, switching operations will be done immediately without confirmation by pressing the Send button.*

Additionally, the menu offers the possibility to get from any console or CPU into the associated configuration menu in the task area.

1. To get directly to Definition > CON Devices, use the right mouse button to click on the respective console in the list and select "Open CON Device."
2. To get directly to Definition > CPU Devices, use the right mouse button to click on the respective console in the list and select "Open CPU Device."

### 5.3 Serial Interface



Figure 5-4. OSD icon.

The ServSwitch DKM FX enables you to switch via a serial interface (RS-232).

Detailed information for the serial interface and the corresponding switching commands can be found in Chapter 6.

### 5.4 Power On and Power Down Functions

The ServSwitch DKM FX has the following power on and power down functions: restart and reset.

#### 5.4.1 Restart

To perform a restart, use OSD.



Figure 5-5. OSD icon.

#### OSD

1. Select "Configuration > Restart Matrix" or "Restart IO Board" in the main menu to restart either the matrix or the I/O boards.
2. To confirm the selection, press the "Yes" button.

The ServSwitch DKM FX will be restarted with the current settings.

#### 5.4.2 Reset

Use the OSD to reset the extender:



Figure 5-6. OSD icon.

*NOTE: If a firmware update has been done since the delivery, the matrix will be set to the state defined there.*

#### OSD

1. Select "Configuration > Reset Matrix" in the main menu.
2. To confirm the selection, press the "Yes" button.

The ServSwitch DKM FX will be reset to the factory settings.

#### 5.4.3 Power Down

Slide the on and off switch at the main sockets of the power supply units to start or switch off the matrix.

## Chapter 6: Serial Control

---

### 6. Serial Control

Use the following parameters to control the ServSwitch DKM FX via its serial interface.

115.2K, 8, 1, NO

(115.2 kbps, 8 data bits, 1 stop bit, no parity)

#### Command

<STX>, <command byte (CMD)>, [data bytes (D0...DN)], <ETX>

[ ] = Optional elements

#### Response

<ACK> , [<ECHO>]

[ ] = Optional elements

<ECHO> reports the ServSwitch DKM FX sequences enabled by a command that shows the new switching status of the ServSwitch DKM FX. The echo can be used to update user applications and to operate several matrices in parallel.

#### Parameter Description

**Command byte:** In the range 0x40 to 0x6F (see the list of allowed commands below).

**Data bytes:** a) To prevent transferring control statements of control commands while transferring binary data, the data are divided into low-nibble and high-nibble. The data are distributed to the low nibbles of two bytes and provided with an offset by 0x60, for example, 0x1F.

=> 0x61 + 0x6F

b) 7-bit data: (0x0 to 0x7F) are provided with an offset by 0x80,  
e.g. 0000011 => 0x83

c) ASCII data => 0x20 to 0x7E are transmitted unencrypted.



(Special) characters:

ACK	0x06
NAK	0x15
STX	0x02
ETX	0x03
CR	0x0D
ESC	0x1B
HTAB	0x09
LF	0x0A

Sequence of a Data Communication

Table 6-1. Data communication sequence.

ServSwitch KVM DKM FX	Control CPU
—	1. Send a command
2. Acquire a command, process a command, block further commands.	—
3. a) Errors occurred: <NAK> b) No errors: <ACK><ECHO> c) Optional: Reply telegram with data	—
—	4. a) Repeat telegram b) Next command c) Receive and process the repeat telegram

NOTE: The serial interface can be blocked while OSD is open.

Switching Functions Telegrams

Table 6-2. Input port's request for output port.

Bytes	Description	Coding
1	Control character	0x1B
1	Server identification	0x5B
1	Command	0x42
2	Total length of telegram (7 bytes, binary)	0x07 0x00
2	Requested output port (binary, 1...max. ports)	0x01 0x00 (for port 1) to 0x120 0x00 (for port 288)

## Chapter 6: Serial Control

---

Example:

Input port's request for output Port 160

0x1B 0x5B 0x42 0x07 0x00 0xA0 0x00

Table 6-3. Return of input port for output port.

Bytes	Description	Coding
1	Control character	0x1B
1	Server identification	0x5B
1	Command	0x42
2	Requested output port (binary, 1...max. ports)	0x01 0x00 (for Port 1) to 0x120 0x00 (for Port 288)
2	Assigned input port (binary, 1...max. ports)	0x01 0x00 (for Port 1) to 0x120 0x00 (for Port 288)

Example:

Input Port 17's return for output Port 160

0x1B 0x5B 0x42 0x09 0x00 0xA0 0x00 0x11x00

Table 6-4. Connection of input port with output port.

Bytes	Description	Coding
1	Control character	0x1B
1	Server identification	0x5B
1	Command	0x43
2	Total length of telegram (9 bytes, binary)	0x09 0x00
2	Requested output port (binary, 1...max. ports)	0x01 0x00 (for Port 1) to 0x120 0x00 (for Port 288)
2	Assigned input port (binary, 1...max. ports)	0x01 0x00 (for Port 1) to 0x120 0x00 (for Port 288)

Example:

Connection of input Port 17 with output Port 160

0x1B 0x5B 0x43 0x09 0x00 0xA0 0x00 0x11 0x00

Table 6-5. Request of input port for output port with a fixed total port number.

Bytes	Description	Coding
1	Control character	0x1B
1	Server identification	0x5B
1	Command	0x44
2	Total length of telegram (9 bytes, binary)	0x09 0x00
2	Number of output ports (binary, 1...max. ports)	0x01 0x00 (for Port 1) to 0x120 0x00 (for Port 287)
2	Requested output port (binary, 1...max. ports)	0x01 0x00 (for Port 1) to 0x120 0x00 (for Port 288)

Example:

Request of input port for output Port 25 with a total port number of 160

0x1B 0x5B 0x44 0x09 0x00 0xA0 0x00 0x19 0x00

Table 6-6. Return of input port for output port with a fixed port number.

Bytes	Description	Coding
1	Control character	0x1B
1	Server identification	0x5B
1	Command	0x44
2	Total length of telegram (7 bytes, binary)	0x07 0x00
2	Number of output ports (binary, 1...max. 288 ports)	0x01 0x00 (for Port 1) to 0x120 0x00 (for 287 ports)

Example:

Return of input Port 17 for output Port 25 with a total port number of 160.

0x1B 0x5D 0x44 0x09 0x00 0xA0 0x00 0x19 0x00 0x11 0x00

Table 6-7. Connection of input port with output port with a fixed total port number.

Bytes	Description	Coding
1	Control character	0x1B
1	Server identification	0x5B
1	Command	0x45
2	Total length of telegram (7 bytes, binary)	0x07 0x00
2	Number of output ports (binary, 1...max. 2887ports)	0x01 0x00 (for Port 1) to 0x120 0x00 (for 287 ports)

Example:

Connection of input Port 17 with output Port 25 with a total port number of 160  
 0x1B 0x5B 0x45 0x07 0x00 0xA0 0x00 0x19 0x00 0x11 0x00

Table 6-8. Request of switching matrix.

Bytes	Description	Coding
1	Control character	0x1B
1	Server identification	0x5B
1	Command	0x46

Table 6-9. Return of the switching matrix (input port for all output ports).

Bytes	Description	Coding
1	Control character	0x1B
1	Server identification	0x5B
1	Command	0x46
2	Total length of telegram (7 bytes, binary)	0x07 0x00
2	Input port whose signal is sent to output port OutPort (n)	0x01 0x00 (for Port 1) to 0x120 0x00 (for 288 ports)

Example:

Return input Port 17 for all output ports

0x1B 0x5D 0x46 0x07 0x00 0x11 0x00

Table 6-10. Request of CPU (input) for CON (output).

Bytes	Description	Coding
1	Control character	0x1B
1	Server identification	0x5B
1	Command	0x46
2	Total length of telegram (7 bytes, binary)	0x07 0x00
2	Requested output console	0x01 0x00 (for Console 1) to 0x11F 0x00 (for Console 287)

Example:

Request of CPU (input) for Console 23

0x1B 0x5B 0x47 0x07 0x00 0x17 0x00

Table 6-11. Return of CPU (input) for CON (output).

Bytes	Description	Coding
1	Control character	0x1B
1	Server identification	0x5B
1	Command	0x47
2	Total length of telegram (9 bytes, binary)	0x09 0x00
2	Requested output console	0x01 0x00 (for Console 1) to 0x11F 0x00 (Console 287)
2	Requested input CPU	0x01 0x00 (for CPU 1) to 0x11F 0x00 (for CPU 287)

Example:

Return of CPU 34 for Console 23

0x1B 0x5D 0x47 0x09 0x00 0x17 0x00 0x22 0x00

## Chapter 6: Serial Control

---

Table 6-12. Connection of CPU (input) with CON (output).

Bytes	Description	Coding
1	Control character	0x1B
1	Server identification	0x5B
1	Command	0x48
2	Total length of telegram (9 bytes, binary)	0x09 0x00
2	Requested console	0x01 0x00 (for Console 1) to 0x11F 0x00 (for Console 287)
2	Requested CPU	0x01 0x00 (for CPU 1) to 0x11F 0x00 (for CPU 287)

Example:

Connection of CPU 43 with Console 23

0x1B 0x5B 0x48 0x09 0x00 0x17 0x00 0x2B 0x00

Table 6-13. Request of CPU (input) for CON (output) with a fixed console number.

Bytes	Description	Coding
1	Control character	0x1B
1	Server identification	0x5B
1	Command	0x49
2	Total length of telegram (9 bytes, binary)	0x09 0x00
2	Total number of consoles (binary, 1...max. CONs)	0x01 0x00 (for Console 1) to 0x11F 0x00 (for 287 Consoles)
2	Requested consoles	0x01 0x00 (for Console 1) to 0x11F 0x00 (for Console 287)

Example:

Request of CPU (input) for Console 23 with 50 consoles in total

0x1B 0x5B 0x49 0x09 0x00 0x32 0x00 0x17 0x00

Table 6-14. Return of CPU (input) for CON (output) with a fixed console number.

Bytes	Description	Coding
1	Control character	0x1B
1	Server identification	0x5D
1	Command	0x49
2	Total length of telegram (7 bytes, binary)	0x07 0x00
2	Total number of consoles (binary, 1...max. CONs)	0x01 0x00 (for console 1) to 0x11F 0x00 (for 287 consoles)

Example:

Return of CPU 43 for Console 23 with 50 consoles in total

0x1B 0x5D 0x49 0x07 0x00 0x32 0x00 0x17 0x00 0x2B 0x00

Table 6-15. Connection of CPU (input) for CON (output) with a fixed console number.

Bytes	Description	Coding
1	Control character	0x1B
1	Server identification	0x5B
1	Command	0x50
2	Total length of telegram (7 bytes, binary)	0x07 0x00
2	Total number of consoles (binary, 1...max. CONs)	0x01 0x00 (for Console 1) to 0x11F 0x00 (for 287 consoles)

Example:

Connection of 43 with Console 23 with 50 consoles total

0x1B -x5B 0x50 0x07 0x00 0x32 0x00 0x17 0x00 0x2B 0x00

## Chapter 6: Serial Control

---

Table 6-16. Request of CON (input) for CPU (output).

Bytes	Description	Coding
1	Control character	0x1B
1	Server identification	0x5B
1	Command	0x51
2	Total length of telegram (7 bytes, binary)	0x07 0x00
2	Total number of consoles (binary, 1...max. CONs)	0x01 0x00 (for CPU 1) to 0x11F 0x00 (for CPU 287)

Example:

Request of CON (input) for CPU 23

0x1B 0x5B 0x51 0x07 0x00 0x17 0x00

Table 6-17. Return of CON (input) for CPU (output).

Bytes	Description	Coding
1	Control character	0x1B
1	Server identification	0x5D
1	Command	0x51
2	Total length of telegram (9 bytes, binary)	0x09 0x00
2	Requested output CPU	0x01 0x00 (for CPU 1) to 0x11F 0x00 (for CPU 287)
2	Requested input console	0x01 0x00 (for Console 1) to 0x11F 0x00 (for console 287)

Example:

Request of Console 23 for CPU 23

0x1B 0x5D 0x09 0x00 0x2B 0x00 0x17 0x00



Table 6-18. Connection of CON (input) with CPU (output).

Bytes	Description	Coding
1	Control character	0x1B
1	Server identification	0x5B
1	Command	0x52
2	Total length of telegram (9 bytes, binary)	0x09 0x00
2	Requested output CPU	0x01 0x00 (for CPU 1) to 0x11F 0x00 (for CPU 287)
2	Requested input console	0x01 0x00 (for Console 1) to 0x11F 0x00 (for Console 287)

Example:

Connection of Console 23 with CPU 43

0x1B 0x5B 0x52 0x09 0x00 0x2B 0x00 0x17 0x00

Table 6-19. Request CON (input) for CPU (output) with a fixed CPU number.

Bytes	Description	Coding
1	Control character	0x1B
1	Server identification	0x5B
1	Command	0x52
2	Total length of telegram (9 bytes, binary)	0x09 0x00
2	Total number of CPUs	0x01 0x00 (for CPU 1) to 0x11F 0x00 (for 159 CPUs)
2	Requested output for CPU (binary, 1...max. CPUs)	0x01 0x00 (for Console 1) to 0x11F 0x00 (for Console 287)

Example:

Request for CPU 43 with 50 CPUs in total

0x1B 0x5B 0x53 0x09 0x00 0x32 0x00 0x2B 0x00

## Chapter 6: Serial Control

---

Table 6-20. Return of CON (Input) for CPU (Output) with a fixed CPU number.

Bytes	Description	Coding
1	Control character	0x1B
1	Server identification	0x5D
1	Command	0x53
2	Total length of telegram (7 bytes, binary)	0x07 0x00
2	Total number of CPUs	0x01 0x00 (for 1 CPU) to 0x11F 0x00 (for 287 CPUs)

Example:

Return of Console 23 for CPU 43 with 50 CPUs in total

0x1B 0x5D 0x53 0x07 0x00 0x32 0x00 0x2B 0x00 0x17 0x00

Table 6-21. Connection of CON (input) with CPU (output) with a fixed total CPU number.

Bytes	Description	Coding
1	Control character	0x1B
1	Server identification	0x5B
1	Command	0x54
2	Total length of telegram (7 bytes, binary)	0x07 0x00
2	Total number of CPUs	0x01 0x00 (for 1 CPU) to 0x11F 0x00 (for 287 CPUs)

Example:

Connection of Console 23 with CPU 43 with 50 CPUs in total

0x1B 0x5B 0x54 0x07 0x00 0x32 0x00 0x2B 0x00 0x17 0x00

Table 6-22. Connection of CON (input) with CPU (output) and CPU (input) with CON (output).

Bytes	Description	Coding
1	Control character	0x1B
1	Server identification	0x5B
1	Command	0x55
2	Total length of telegram (9 bytes, binary)	0x09 0x00
2	Requested CPU	0x01 0x00 (for 1 CPU) to 0x11F 0x00 (for 287 CPUs)
2	Requested console	0x01 0x00 (for Console 1to 0x11F 0x00 (for Console 287)

Example:

Connection of Console 23 (input) with CPU 43 (output)

0x1B 0x5B 0x55 0x09 0x00 0x2B 0x00 0x17 0x00

Table 6-23. Connection of CON (input) with CPU (output) and CPU (input) with CON (output) with a fixed CPU number.

Bytes	Description	Coding
1	Control character	0x1B
1	Server identification	0x5B
1	Command	0x56
2	Total length of telegram (7 bytes, binary)	0x07 0x00
2	Total number of CPUs	0x01 0x00 (for 1 CPU) to 0x11F 0x00 (for 287 CPUs)

Example:

Connection of Console 23 with CPU 43 and Console 24 with CPU 44 with 50 existing CPUs

0x1B 0x5B 0x56 0x07 0x00 0x32 0x00 0x2B 0x00 0x17 0x00 0x2C 0x00

0x18 0x00

# Chapter 7: Troubleshooting

---

## 7. Troubleshooting

Tables 7-1 through 7-7 in Sections 7.1 through 7.7 provide support for problems with the ServSwitch DKM FX matrix. This help assumes a functional extender route. Before running, make sure your extenders' matrixes work over a peer-to-peer connection. This can be supported by the use of a CATx or fiber coupler.

### 7.1 External Failure

Table 7-1. External failure.

Problem	Possible Cause	Solution
ServSwitch DKM FX cannot be started	Fuse at the standard appliance outlet is out	Check fuse

### 7.2 Video Interference

Table 7-2. Video interference.

Problem	Possible Cause	Solution
Opening the OSD is not possible	No OSD jumper set	Set Jumper 11 on the CON unit
Incorrect video display	Cable connection disturbed	Check the connection, length, and quality of the interconnection cable to the units

### 7.3 Fans Malfunction

Table 7-3. Fans malfunction.

Problem	Possible Cause	Solution
Fans only run under full load	Communication to fan tray is disturbed	Remove and reinstall the fan tray
Fans do not run; LED OK is on	Fans are defective	Contact Black Box Technical Support at 724-746-5500 or info@blackbox.com

## 7.4 Power Supply Units Malfunction

Table 7-4. Power supply units malfunction.

Problem	Possible Cause	Solution
ServSwitch DKM FX cannot be started	Power supply units not locked correctly	Check the power supply unit's lock and plug-in
	No power supply is available	Check that cables for the power supply are connected correctly
	Power supply units are not switched on	Check the slide to switch on the power supply units

## 7.5 Network Error

Table 7-5. Network error.

Problem	Possible Cause	Solution
Network settings are not resumed after editing	ServSwitch DKM FX restart is not yet completed	Restart the unit

## 7.6 ServSwitch DKM FX Failure

Table 7-6. ServSwitch DKM FX failure.

Problem	Possible Cause	Solution
Serial control is impossible or restricted	CPU and ServSwitch DKM FX are running at a different baud rate	Adapt the baud rate in the ServSwitch DKM FX and in the CPU
Serial control via the RJ-45 port is not possible	Wrong network cable	Use a cross-pinned network cable
Port definitions as USB 2.0 invalid	ServSwitch DKM FX restart not yet completed	Restart the ServSwitch DKM FX

## 7.7 Blank Screen

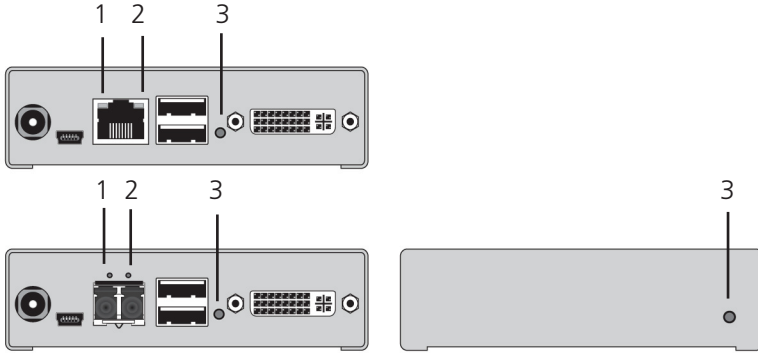

Figure 7-1. LEDs on the ServSwitch DKM FX.

Table 7-7. LED indications.

Problem	Possible Cause	Solution
Monitor remains dark after switching operation	Switching to a CPU port without active source (computer, CPU)	Connect the computer or CPU
	Connection of a console with a CON port or connection of a CPU to a CPU port not established correctly	Check CON and CPU port connections at the ServSwitch DKM FX
LED 1 on or LED 2 off	Connections of the CON unit, ServSwitch DKM FX, and the CPU unit	Check the cables and connectors (no cable, cable break, CPU/CON unit off-line, CPU/CON unit connected to the wrong port)
LED 3 off	Power supply	Check the power supply units and connection to the power network

## 7.8 Contacting Black Box

If you determine that your ServSwitch DKM FX is malfunctioning, do not attempt to alter or repair the unit. It contains no user-serviceable parts. Contact Black Box Technical Support at 724-746-5500 or [info@blackbox.com](mailto:info@blackbox.com).

Before you do, make a record of the history of the problem. We will be able to provide more efficient and accurate assistance if you have a complete description, including:

- the nature and duration of the problem.
- when the problem occurs.
- the components involved in the problem.
- any particular application that, when used, appears to create the problem or make it worse.

### 7.9 Shipping and Packaging

If you need to transport or ship your ServSwitch DKM FX:

- Package it carefully. We recommend that you use the original container.
- If you are returning the unit, make sure you include everything you received with it. Before you ship for return or repair, contact Black Box to get a Return Authorization (RA) number.

### Appendix. Glossary

The following terms are commonly used in this guide or in video and KVM technology:

**AES/EBU** — Digital audio standard officially known as AES3, used for carrying digital audio signals between devices.

**CATx** — Any CAT5e (CAT6, CAT7) cable.

**CGA** — The Color Graphics Adapter (CGA) is an old analog graphics standard with up to 16 displayable colors and a maximum resolution of 640 x 400 pixels.

**Component Video** — The Component Video (YPbPr) is a high-quality video standard that consists of three independently and separately transmittable video signals, the luminance signal, and two color difference signals.

**Composite Video** — The Composite Video is also called FBAS and it is part of the PAL TV standard.

**CON Unit** — Component of a ServSwitch DKM FX or media extender that connects to the console (monitor[s], keyboard and mouse; optionally also with USB 2.0 devices).

**CPU Unit** — Component of a ServSwitch DKM FX or media extender that connects to a source (computer, CPU).

**DDC** — The Display Data Channel (DDC) is a serial communication interface between a monitor and a source (computer, CPU). It enables data exchange via monitor cable and automatic installation and configuration of a monitor driver by the operating system.

**Dual Access** — A system that operates a source (computer, CPU) from two consoles.

**Dual-Head** — A system with two video connections.

**Dual Link** — A DVI-D interface for resolutions up to 2560 x 2048 by signal transmission of up to 330 MPixel/s (24-bit).

**DVI** — Digital video standard, introduced by the Digital Display Working Group (<http://www.ddwg.org>). See also Single Link and Dual Link. The signals have TMDS level.

**DVI-I** — A combined signal (digital and analog) that allows running a VGA monitor at a DVI-I port—in contrast to DVI-D (see DVI).



**Fiber** — Single-mode or multimode fiber cables.

**EGA** — The Enhanced Graphics Adapter (EGA) is an old analog graphics standard, introduced by IBM® in 1984. It uses a DB9 connector.

**FBAS** — The analog color video baseband signal (FBAS) is also called Composite Video and it is part of the PAL TV standard.

**Console** — Keyboard, mouse, and monitor.

**KVM** — Keyboard, video, and mouse.

**Mini-XLR** — Industrial standard for electrical plug connections (3-pole) for the transmission of digital audio and control signals.

**Multimode** — 62.5- $\mu$  or 50- $\mu$  fiber cable.

**OSD** — An OSD (on-screen display) is used to display information or to operate a device.

**Quad-Head** — A system with four video connections.

**RCA (Cinch)** — A non-standardized plug connection that transmits electrical audio and video signals, especially with coaxial cables.

**SFP** — SFPs (Small Form Factor Pluggables) are pluggable interface modules for Gigabit connections. SFP modules are available for CATx and fiber interconnect cables.

**S/PDIF** — A digital audio interconnect used in consumer audio equipment over relatively short distances.

**Single-Head** — A system with one video connection.

**Single Link** — A DVI-D interface for resolutions up to 1920 x 1200 by signal transmission of up to 165 MPixel/s (24-bit). Alternative frequencies are Full HD (1080p), 2K HD (2048 x 1080), and 2048 x 1152.

**Single-Mode** — 9 $\mu$  fiber cable.

**S-Video (Y/C)** — The S-Video (Y/C) is a video format that transmits luminance and chrominance signals separately. It has a higher-quality standard than FBAS.

**TOSLINK®** — Standardized fiber connection system for digital transmission of audio signals (F05 plug connection).

**Triple-Head** — A system with three video connections.

**USB HID** — USB HID devices (human interface devices) allow for data input. You don't need a special driver during installation; "New USB-HID device found" is reported. Typical HID devices include keyboards, mice, graphics tablets, and touchscreens. Storage, video, and audio devices are not HID.

**VGA** — Video Graphics Array (VGA) is a computer graphics standard with a typical resolution of 640 x 480 pixels and up to 262,144 colors. Its is preceded by the graphics standards MDA, CGA and EGA.

### A.1 Matrix-Specific Glossary

**Auto Disconnect** — Matrix function that allows an automatic disconnect between a console and a CPU, if the OSD is opened via this console.

**Auto Logout** — Matrix function that describes the duration of inactivity after the user has been logged out from the OSD at this console.

**CON Device** — Logical term that summarizes several physical extenders to switch more complex console systems via matrix.

**CON Timeout** — Matrix function that allows an automatic disconnect of the console from the connected CPU after a predefined time.

**Console ACL** — Console ACL (Access Control List) is a list that shows the respective switching rights for the various consoles.

**CPU Auto Connect** — Matrix function that allows an automatic connection establishment between the own console and a random available CPU.

**CPU Device** — Logical term that summarizes several physical extenders to switch more complex CPU systems via matrix.

**CPU Timeout** — Matrix function that allows the user to disconnect after a predefined period of time of inactivity from the respective CPU.

**EXT Unit** — Part or extender board of a CON or CPU unit with a connection to the matrix. A CON or CPU unit can consist of several EXT devices.

**Force Connect** — Matrix function that allows a user to switch with his own console to a CPU that is already used. This enables the user to take keyboard and mouse control. The connected console loses K/M control but keeps video.

**Force Disconnect** — Matrix function that allows to switch with the console to a CPU that is already used. This enables the user to take KVM control. The connected console loses complete KVM control.

**Java Tool** — Java based control and configuration tool for the ServSwitch DKM FX matrix.

**Keyboard Connect** — Matrix function that allows taking over the keyboard control of an inactive console.

**Macro Keys** — Programmable keys that string together commands to the matrix.

**Mouse Connect** — Matrix function that enables a user to control an inactive console's mouse.

**Non-Blocking-Access** — Matrix configuration in which no user can be disturbed by an activity of another user.

**OSD Timeout** — Matrix function that closes the OSD automatically after a predefined period of time of inactivity.

**Release Time** — Matrix function that enables a console connected to the same CPU to release the K/M control after a predefined time.

**Tie-Line** — Communication connection to and between extension modules in a network environment.

**User ACL** — User ACL (Access Control List) is a list that shows the respective switching rights for the various users.

**Video Sharing** — Matrix function that enables switching from a user's own console to any CPU with video.

**Black Box Tech Support: FREE! Live. 24/7.**

Tech support the  
way it should be.



Great tech support is just 30 seconds away at  
724-746-5500 or [blackbox.com](http://blackbox.com).



## About Black Box

Black Box provides an extensive range of networking and infrastructure products. You'll find everything from cabinets and racks and power and surge protection products to media converters and Ethernet switches all supported by free, live 24/7 Tech support available in 30 seconds or less.

© Copyright 2011. Black Box Corporation. All rights reserved. Black Box® and the Double Diamond logo are registered trademarks of BB Technologies, Inc. Any third-party trademarks appearing in this manual are acknowledged to be the property of their respective owners.

ACX048, version 1

---

724-746-5500 | [blackbox.com](http://blackbox.com)