



ACU800A-PSTN

**mm146 IP Videophone**

**mm156 IP/PSTN Videophone**

**User Guide**

**Black Box Web Site**

- <http://www.blackbox.co.uk>

**Product Support**

If you have a problem with your videophone:

- First check the Troubleshooting chapter of this manual.
- Check the Black Box web site for relevant information.
- If you still have a problem, contact Black Box Technical Support.
- If this is not possible, contact Customer Services:

- **UK and International:**  
Tel: +44 (0) 118 9656000

You will be asked to supply the following information (found on the base of your videophone):

**Model number:** .....

**Serial number:** .....

## **IMPORTANT SAFETY INFORMATION**

- Do not dismantle the videophone. There are no user serviceable parts inside. Access to the inside of this unit should only be carried out by approved service personnel.
- Keep the videophone away from water and other liquids (except when cleaning, as directed below). If you suspect that liquid has entered the equipment, immediately disconnect the unit from the network and from the power supply, ensuring first that your hands and the power supply outlet area are dry. Do not use the videophone again until it is thoroughly dry.
- Clean the case only with a soft, lint-free cloth, either dry or slightly dampened with water. Disconnect the power and the telephone cables before using a damp cloth to clean the videophone.
- Before connecting any equipment that was not supplied with the videophone, check the specification to ensure compatibility.
- Do not use the videophone if you suspect a gas leak. Operation of any electrical equipment can generate sparks which may ignite the gas and cause an explosion.
- Do not let cables trail where they might cause someone to trip or pull the videophone onto the floor.
- Use only on a stable surface. The videophone may be damaged if it falls.
- Do not place any part of this equipment in your mouth.
- Keep the equipment and its packaging out of reach of small children.
- Do not push objects into the ventilation slots.
- Do not block the ventilation slots as this could cause the equipment to overheat and malfunction. Do not use it on a soft surface such as a bed which might block ventilation slots.
- Do not place the videophone in direct sunlight. Do not point any external cameras directly at the sun as this is likely to cause serious damage to the unit.
- The videophone will not function in the event of a power cut. It should not be relied upon as the only means of contacting the emergency services.

### **Connection to the Power Supply**

- Never overload power sockets.
- In order to remove power from this product, you must disconnect the power plug from the power outlet. In order to safely achieve this action, the product must be installed close to the power outlet and be positioned in such a way that user access to the power plug and socket connection is not restricted.
- The product must only be used with the provided power supply. This power supply has been extensively tested for use with the product, use of an alternative power unit may invalidate any international type approval relating to the product.
- If the power unit, cable or plug becomes damaged, contact the dealer for a suitable replacement. There are no serviceable parts inside. Disconnect the power source before attempting to handle a damaged power supply unit or damaged power cable or plug. Any attempt to open the power unit is likely to expose a potential electric shock hazard.

# Introduction & Getting Started



This guide describes all the features of the mm146 and mm156 videophones and is written both for administrators who are responsible for installing and configuring the videophone and those who use it on a day-to-day basis.

## About the mm146 and mm156 IP videophones

The mm146 and 156 IP videophones offer a major advance in video over broadband and corporate IP networks. Designed specifically for non-QoS IP connections, this attractive system is as easy to use as a telephone, but offers a wide range of capabilities.

### **With the mm146 videophone you can:**

1. Make toll-free videophone calls over the Internet.
2. Make group conferencing video calls using an external camera and TV.
3. Make multipoint conference calls using an external MCU.
4. Make calls to or audio conference ISDN videophones, regular phones and mobiles using an external gateway.

### **With the mm156 you can additionally:**

1. Make calls to or audio conference regular phones and mobiles over a regular telephone line.
2. Make video calls over a regular telephone line

## Unique technology

mm146 and mm156 videophones offer a range of unique features that improve the user and administrator experience

### **Motion Media's Packet Buddy protocol**

1. Intelligently adapts to the available bandwidth over the Internet,
2. Recovers lost packets
3. Synchronises video and audio to provide excellent lip-sync.

### **Simplified installation**

1. The IP videophones support DHCP and PPPoE protocols, allowing automatic configuration of the core IP information.
2. The Packet Buddy Protocol uses a single UDP port to make a video call instead of the 6+ ports used by an H323 device. This allows outgoing calls to be made with little or no firewall configuration.

### **Reduced infrastructure costs**

1. When first using mm146 and 156 videophones no dedicated video infrastructure (e.g. H.323 aware firewalls, gatekeepers, QoS Internet services, etc.) is

required. This means you can experience the benefits of video without an extensive and costly implementation phase.

2. Moving forward, mm146 and mm156 videophones also support the H.323 protocol, so can adapt to future infrastructure changes, and interoperate with equipment from other vendors.

### **Enhanced video calls**

A range of features give the user greater flexibility when in a call. These include:

1. Full-duplex Acoustic Echo Canceller for pause-free hands-free audio conferences with no clipping.
2. Digital zoom
3. Image control (faster/sharper)
4. Local and remote audio and video source selection in call
5. Brightness control
6. Adjustable PiP
7. Freeze frame option
8. PIN authentication for security

### **Improved ease of use**

1. Video and audio calls from one phone (mm156)
2. Fallback to PSTN (mm156)
3. Central phonebook facility
4. Built-in 10/100 hub allowing a PC to share your videophone connection
5. Physical camera cover for complete privacy

# Getting Started

## Requirements for the IP Videophone

The mm146 unit requires the following:

- Power outlet
- 10 or 100 Base-T LAN (Local Area Network) connection

The mm156 additionally requires

- standard analog telephone line

but may operate over either the PSTN or an IP network.

## Unpacking

Your shipment should contain the following components:

- Videophone unit and handset
- Power supply and mains lead
- Standard network cable (RJ-45) and handset cable
- PSTN line cable (mm156 only)
- Product warranty card and software license agreement
- User Guide and Quick Start Guide

Unwrap all the components carefully. If any components are missing, contact your supplier.



## Connecting the Equipment

**Read the Safety Information at the front of this manual.**

**To connect the handset:**

1. Plug the handset cable into the handset, then connect the other end into the socket on the base of your videophone.
2. Press the handset cable into the channel on the base of the unit.

**To connect the PSTN line cable (mm156 only)**

1. Connect one end of the PSTN line cable to the RJ-11 socket underneath the videophone,
2. Connect the other end into the phone line jack on the wall.

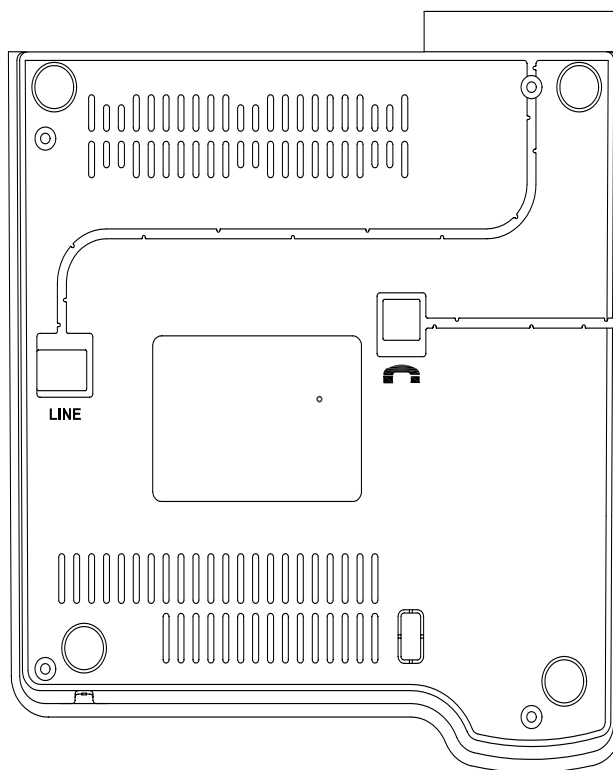

### To connect the network cable:

1. Connect one end of the network cable into the socket labeled **Network** at the rear of the videophone,
2. Connect the other end into your RJ-45 network jack.

### To connect the PC (optional):

1. Connect one end of the PC cable into the network port of the PC,
2. Connect the other end into the port labeled Uplink/PC. The specification for this cable is a standard, straight-pinned Cat 5.

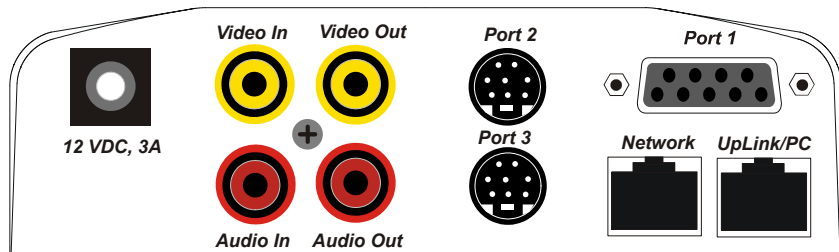

## Connecting the Power Supply





### To connect the power supply:

1. Connect the power supply adapter to the circular power jack labeled **12 VDC, 3A** on the back of your videophone (see page 36).
2. Connect the other end of the power supply adapter to your wall outlet. The status light on the front of your videophone turns from flashing green to solid green when the videophone is ready to make a call. A few seconds later the introductory screen displays on the LCD screen.

## “Waking” the Videophone

If your videophone remains unused for approximately 20 minutes, it will go into “sleep” mode and the screen appears blank.

### To “wake” the videophone:

- Lift and replace the handset, or
- Press the  **start** button, or
- Press the  **menu** button, or
- Press the   button, or
- Press the round arrow center button.

## Getting the Best from your Videophone

There are a few steps you can take when setting up the videophone to ensure that you get the best results.

### Focusing the Camera

You can focus the built-in camera on your videophone to ensure that the video image you send is crisp and clear.

#### To focus the camera:

1. Press the  **menu** button to display the Setup Menu options.
2. Press the number **3** key to view the Camera Video Setup options.
3. Press the number **1** key to view the built-in camera preview. You should see yourself on the screen.
4. Slowly twist the outer ring of the camera either way to bring the image into sharp focus. Usually only a small adjustment is required.

### Lighting

As with conventional photography, correct lighting is vital to achieving the best results from your videophone.

Make sure your face is well lit, preferably from the front, and avoid having lights behind you that might shine into the camera lens.

## **Movement**

Too much movement tends to slow down the frame rate of the video, resulting in a distorted picture. Avoid having a lot of movement in the background – for example, do not sit with your back to a corridor – and try not to move around excessively. This does not mean you have to sit completely still: just move naturally, but be aware that if you make rapid movements, the person you are calling may see a distorted picture.

You can control the frame rate of the video you are sending, to adjust the balance between smoothness and clarity. See Images on page 33, for more information. If movement is important, set the Video Mode to *Motion*; if clarity is important, set the Video Mode to *Detail*.

## **Sound**

Where possible, it is better to choose a quiet environment than a noisy one. In very noisy situations you will find the handset more effective than handsfree.

When using handsfree, remember that the built-in microphone is at the front right-hand corner of the videophone. Don't cover this with your hand, or tap on the videophone case.

You should avoid picking up or moving the videophone during a call.

# Setting up the videophone

This chapter explains the menu structure. It then tells you how to navigate the menus that control the cameras and communications.

If you are setting up the mm146 or mm156, you should follow the steps in this chapter and then go on to the next chapter which explains how to make calls.

## Setup Menu

The videophone is configured using the Setup Menu. The Setup Menu provides a number of options that display further menus and information screens.

### To access the Setup Menu:

Press the  **menu** button on your videophone.

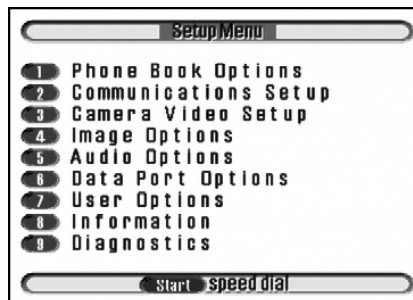

## Menu Layout

All the menus and information screens have the same format as the Setup Menu:

- **Title Bar:** At the top of all menus, indicates the menu you are currently viewing.
- **Button Bar:** At the bottom of all menus, displays information about keys used for navigating through the menus.

## Selecting Menu Options

The menus also have numbered options.

### To select an option:



- Press the number key corresponding to the option you require, or
- Use the Up and Down arrow keys to highlight the option.
- Press the round centre button to activate an option.

## Changing a Setting within a Menu Field

The menus that you access from the Setup Menu contain a number of fields. Some of these fields have default settings which are displayed for you.

The way in which you navigate through the menus, change settings and save your changes is the same in each case:

<b>Highlighting a field</b>	Use the Up and Down arrow keys on the key pad to move the cursor to the field you want to change. When the field is highlighted, you can change its setting.
<b>Changing a setting</b>	Use the Left and Right arrow keys to scroll through pre-defined settings, such as <b>ON</b> and <b>OFF</b> . Display the setting that you want to use.
<b>Entering numbers</b>	Use the number keys to enter numbers such as an IP address.
<b>Entering letters</b>	Also use the number keys to enter text. When you have highlighted a field that requires text, the “mode” of the number keys is automatically changed to enter letters. The 1 to 9 keys represent more than one letter. Press a key repeatedly to change the letter. When you have displayed the letter you require, use the Right arrow key to move to the next space and be able to enter another letter.

<b>Saving Changes</b>	When all changes have been made within a setup menu, press the  <b>enter</b> button twice. The message: “ <i>Saving Changes...</i> ” is displayed on your screen.
<b>Canceling an action</b>	Press the  <b>exit</b> button.

## Setup Menu Options

All the menus are displayed from the Setup Menu. The Setup Menu options are:

<b>Phone Book Options</b>	Allows you to enter and edit entries in your Phone Book. Allows you to set the videophone to Master or Slave mode and allows a slave unit to import phone book entries from a master Phone Book. See “Setting the Phone Book Mode” on page 16.
<b>Communications Setup</b>	Displays the Communications Setup menu which allows you to access the Network Setup menu for setting the communications parameters for your Analog connection, IP network and also set the H323 settings, Data Speed, Auto Answer, Auto Dialer, and Intercom options. See “Communications Setup” on page 17.
<b>Camera Video Setup</b>	Displays the Camera Video Setup menu in which you set up video presets and remote access. See “Setting Camera Video Presets” on page 40.
<b>Image Options</b>	Displays the Image Options menu in which you set up the image properties for transmission. See “Configuring the Image Options” on page 25.
<b>Audio Options</b>	Displays the Audio Options menu which allows you to configure audio inputs. See “Configuring the Audio Options” on page 26.
<b>Data Port Options</b>	Displays the Data Port Options menu in which you configure the data ports for data transfer and PTZ camera control. See “Using the Data Ports” on page 49.
<b>User Options</b>	Displays the User Options menu in which you can set the User ID, the User PIN and Supervisor PIN numbers. See “Changing the User Options” on page 45.
<b>Information</b>	Displays information including the Customer Services number, the serial number and the software version of your videophone. See “The Information Screen” on page 53.
<b>Diagnostics</b>	Displays information about the last call and network statistics. See “Diagnostic Information” on page 54.

## Setting up the Phone Book

You can input up to 50 entries in the Phone Book. Each entry contains the name of the contact, the type of call being placed, IP address or alias, telephone number, and a security PIN if the called party requires PIN authorization.

### Using the Phone Book

Open the speed dial list in the Phone Book by pressing the  start button

- Use the Right and Left arrow keys to scroll through the pages of contacts and view all entries in your Phone Book.
- Press a number key on the key pad to make a call to the desired contact.

### Entering Contacts in the Phone Book

To enter a new name and details in the Phone Book:

1. Press the  menu button, then press the number **1** key to display the Phone Book options.

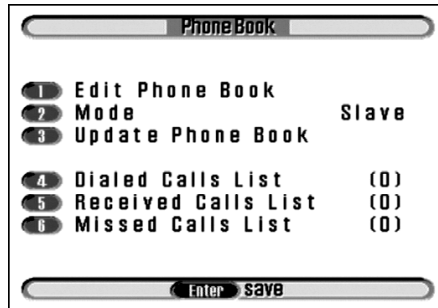

2. Press the number **1** key to edit the Phone Book.

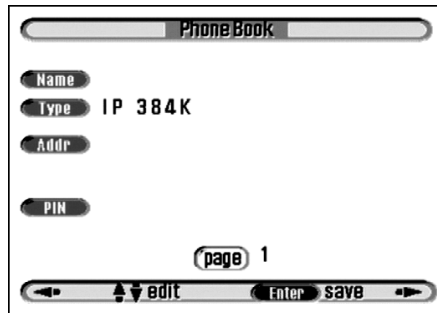

3. Highlight the **Name** field using the Up or Down arrow keys. Enter the name of the contact using the number keys on the key pad which are also labeled with



letters. The name you enter also appears in your Speed Dial directory. (*NOTE:* If you are using the name as an H.323 alias in conjunction with a gatekeeper, avoid using spaces in the name.)

- Press a number key to cycle through the letters until your choice is displayed.
  - Press and hold the key if you wish to change between upper and lower case characters.
  - Press the Right arrow key to move one space to the right to enter the next letter.
  - Press the Left arrow key to delete the previous character.
4. Highlight **Type** and select the connect speed of the videophone. Select either **IP 32K**, **IP 48K**, **IP 64K**, **IP 96K**, **IP 128K**, **IP 160K**, **IP 192K**, **IP 256K**, **IP 320K**, **IP 384K**, **Analog** (mm156 only) or **PING**. For Asymmetrical mode, (first number represents maximum receive speed, second number represents maximum transmit speed) select either **IP 48/32K**, **IP 64/32K**, **IP 96/32K**, **IP 128/32K**, **IP 160/32K**. Choose **PING** to test the network path to another device.
  5. Highlight the **Addr** field and enter the IP address or telephone number of the party you are calling using the number keys. Use the \* key (located at the bottom left of the number pad), or enter a space using the Right arrow key to represent a period (.) in the IP address. If you enter a number greater than 255 you are notified that an invalid IP address has been entered. The **Addr** field stays highlighted until a valid IP address is entered.
  6. Press the **✓enter** button once to save the entry.
  7. To enter another number in the Phone Book, press the Right arrow key and follow steps 3 to 5, above.
  8. Press the **✓enter** button twice, to save the information you have entered in the Phone Book and exit.

## Entering a PIN for a Contact

Using a PIN is optional. However, you must enter the PIN if the person you are calling has this security feature enabled. For information about setting up a PIN, see “Changing the User Options” on page 45.

## Setting the Phone Book Mode

There are two possible modes for the videophone.

- Master
- Slave

The videophone is supplied in *Slave* mode by default. If you have multiple units within a LAN, you need to configure 1 unit in your network to be a *Master* unit. The Master unit can then be configured with entries in the Phone Book. See “Setting up the Phone Book” on page 14.

The Slave units within the same network can then be updated with Phone Book entries contained in the Master unit. In this way, multiple Slave units on your LAN can easily be updated with the Phone Book from a single Master unit.

### To set the Mode of your videophone to Master:

1. Press the  **menu** button, then press the number **1** key to display the Phone Book options.

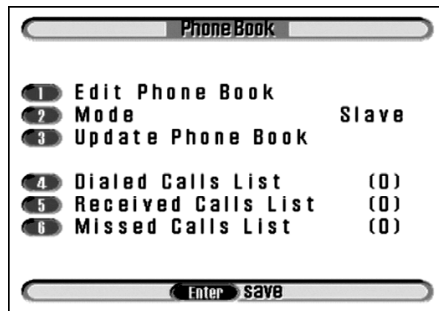

2. Press the number **2** key to highlight the **Mode** field.
3. Use the Right or Left arrow keys to select **Master**.

Press the  **enter** button twice to save the changes

## Updating Slave Units with Master Phone Book

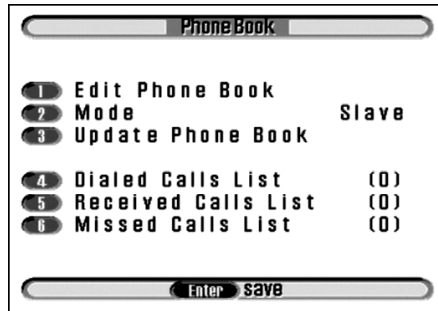

To update a Slave unit with the Master Phone Book entries:

1. Press the  **menu** button, then press the number **1** key to display the Phone Book options.



2. Press the number **3** key to Update the Phone Book.

**To check your updated Phone Book on a Slave unit:**

1. Press the  **exit** button twice, then press the  **start** button.
2. The Speed Dial list displays with the imported Phone Book entries from the Master Phone book.

## Communications Setup

**To configure the Communications Setup options:**

1. Press the  **menu** button, then press the number **2** key to display the Communications Setup menu.

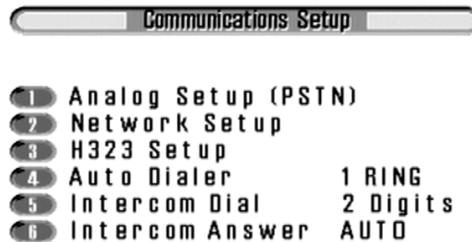

2. Use the number keys, or press the Up or Down arrow keys to select an option in the list.

<b>Analog Setup (PSTN)</b>	Select Analog Setup to configure the modem, dial prefix, and autoanswer.
<b>Network Setup</b>	Select this option to access the Network Setup menu to configure the IP addresses and UDP Port address relevant to your network.
<b>H323 Setup</b>	Only enable H323 if a Gatekeeper is present on the network.
<b>Auto Dialer</b>	The Auto Dialer feature is for setting the first entry in the speed dial to be dialed automatically when an external alarm connected to the mm146 is activated. Note that the default setting is <b>OFF</b> . Use the Right or Left arrow keys to select <b>ON</b> or <b>OFF</b> . Select <b>ON</b> to activate Auto Dialer. Select <b>OFF</b> to turn the auto dialer off.
<b>Intercom Dial</b>	The Intercom feature allows you to dial the last part of the IP address of other IP videophones within your network. Set the Intercom Dial feature to <b>2 Digits, 3 Digits</b> or <b>4 Digits</b> , depending on the IP addresses used within your network, using the Right or Left arrow keys on your key pad. The intercom feature is suitable only for IP video calls, and is not appropriate for analog calls.
<b>Intercom Answer</b>	The Intercom Answer feature allows you to receive calls automatically or manually when an Intercom number is dialed. Use the Right or Left arrow keys to select <b>AUTO</b> or <b>MANUAL</b> . Select <b>AUTO</b> to enable a video call to start automatically when you receive an intercom call. Select <b>MANUAL</b> to allow a video call to start only when the  <b>start</b> button is pressed or the handset is picked up.

## Analog Setup (PSTN)

Analog Setup (PSTN) allows you to configure various call options on your videophone.

### To access the Analog Setup menu:

1. Press the **Menu** button, then press the number **2** key to access Communication Setup, then the number **1** key to access Analog Setup..

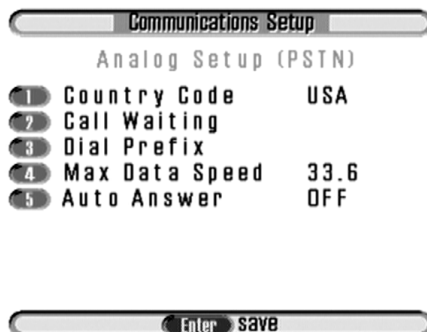

2. Use the number keys to select an option in the list.

<b>Country Code</b>	Use the Left or Right arrow keys to scroll through the country code options.
<b>Call Waiting</b>	You may need to disable the Call Waiting feature on your videophone to prevent the disruption of video calls. Enter a key combination using the <b>0</b> to <b>9</b> number keys, the * key, the # key. For example, enter <b>*70</b> . Consult your phone provider or Black Box for advice.
<b>Dial Prefix</b>	Enter the dial prefix using the number keys. For example enter <b>9</b> , if you need an outside line.
<b>Max Data Speed</b>	Set the modem speed using the Left or Right arrow keys. The modem speed is set to 33.6. You should not normally need to change this.
<b>Auto Answer</b>	Set Auto Answer to between <b>3 RINGS</b> and <b>8 RINGS</b> or <b>OFF</b> .

3. Press the **ENTER** key twice to save the changes to this menu screen and to return to the Setup Menu.

# Network Setup

The IP addresses for your videophone must be configured using the Network Setup menu. Either this can be set manually (static setting) or more usually, DHCP (Dynamic Host Control Protocol) is enabled, when the address allocation is done automatically. When DHCP is enabled, the IP Address, Net Mask and Gateway options are greyed out as these parameters are setup automatically.

## To configure the Network Setup options:

1. Press the  **menu** button, then press the number **2** key to display the Communications Setup menu.

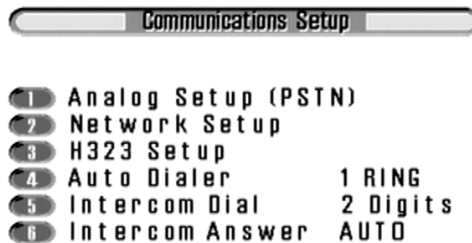

2. Press the number **2** key to access the Network Setup menu.

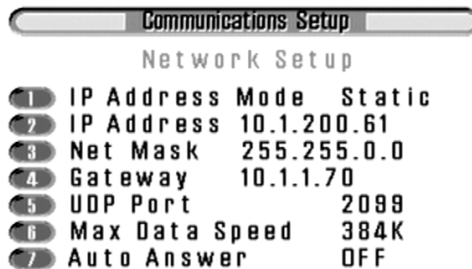

- 3.

Use the number keys, or press the Up or Down arrow keys to select an option in the list.

<b>IP Address Mode</b>	Options are either <b>STATIC</b> , <b>DHCP</b> (Dynamic Host Configuration Protocol), or <b>PPPoE</b> (Point-to-Point Protocol over Ethernet). When <b>DHCP</b> is enabled the IP Address, Net Mask and Gateway are setup automatically at the beginning of each session. Using <b>PPPoE</b> you will additionally need to enter the user name and password used with your Internet Service Provider. When <b>Static</b> is selected, the IP Address, Net Mask and Gateway need to be setup.
<b>IP Address</b>	Obtain an <b>IP Address</b> from your Network Administrator or Service Provider. Enter the IP Address in the IP Address field. Use the number keys on the key pad; use the * key (located at the bottom left of the key pad) or the Right arrow key to enter a space to represent a period (.) in the IP address.
<b>Net Mask</b>	Change the <b>Net Mask</b> to a valid subnet mask for your network (for example 255.255.255.0). Use the number keys on the key pad; use the * key (located at the bottom left of the key pad) or the Right arrow key to enter a space to represent a period (.) in the IP address.
<b>Gateway</b>	Change the <b>Gateway</b> to reflect the gateway for your network (for example 192.168.1.254). Calls are routed to the gateway if the destination address is in a different IP subnet. Use the number keys on the key pad; use the * key (located at the bottom left of the key pad) or the Right arrow key to enter a space to represent a period (.) in the IP address.
<b>UDP Port</b>	Enter the <b>UDP Port</b> number using the number keys on the key pad. The UDP port allows multiple units to share the external IP address of your firewall. Setup the firewall to forward all packets with a particular UDP port number to the local address of the videophone.  The UDP port number can also be set to match permitted ports on the firewall for ease of installation.

<b>Max Data Speed</b>	Select the Max Data Speed using the Right or Left arrow keys on your key pad. The Max Data Speed feature is for limiting the bandwidth used for incoming calls. This allows you to force all incoming calls to connect at a lower speed in case your gateway/network has a smaller bandwidth than 160kps. Most video calls are symmetrical and transmit and receive data at the same speed (32K, 48K, 64K, 96K, 128K, 160K, 192K, 256K, 320K, 384K). Asymmetrical mode allows the user to receive at high speeds (48K, 64K, 96K, 128K, or 160K) but only transmit data at 32K.
<b>Auto Answer</b>	The Auto Answer feature is for setting the number of rings to automatically answer the call. The default is <b>4</b> rings. Use the Right or Left arrow keys to set Auto Answer between <b>1 RING</b> and <b>8 RINGS</b> or <b>OFF</b> . If OFF is selected calls are not answered automatically.

4. Press the **✓enter** button twice to save the information selected in this menu.

## Static and Dynamic IP addresses

### DHCP (Dynamic Host Configuration Protocol)

DHCP is used to assign IP addresses to each device on a network from a central server. A DHCP assigned address will usually remain the same if the server or videophone is reset or rebooted, but your IP address may change if you use DHCP over an extended period of time.

To ensure constant availability of your videophone, you must either register it with a gatekeeper (see H.323 settings), or fix the IP address by changing the setting from DHCP to STATIC once configured.



## To setup the unique Port number on the videophone

1. Press the  **menu** button, then press the number **2** key to display the Communications Setup menu. Then Press the number **2** key to access the Network Setup menu.

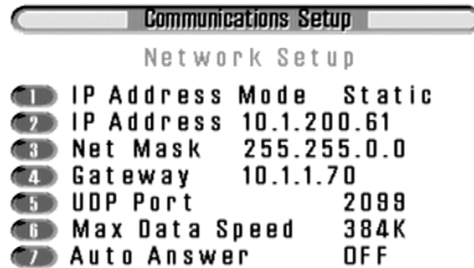

2. Press the number **5** key to access the UDP Port function. Input the number, and press Enter twice to save and exit.

The **caller** may append the unique port number of each videophone to the IP address when making a call: *format 10.1.200.6:2099*

where 2099 is the UDP Port number of the recipient's videophone.

The port number is separated from the IP address by a colon (:), entered using the right arrow key.

The UDP port number can be configured for two purposes.

3. To allow incoming calls to be forwarded to the videophone using the firewall's external IP address, and a port forwarding function in the firewall
4. To create a video/audio port stream range that matches the range of ports opened in the firewall for other H.323 devices (typically 5000 to 5010).

## H323 Setup

A gatekeeper controls admission of data into and out of the building, references telephone numbers to IP addresses, manages user bandwidth over the WAN. Some Gatekeepers act as the Proxy port as well, and can assist data in traversing the Firewall.

**To configure the H323 Setup options:**

1. Press the  **menu** button, then press the number **2** key to display the Communications Setup menu, then press the number **3** key to access the **H323 Setup** menu.



Press the number **1** key to access the Network Setup menu..

<b>H.323 ID</b>	The H.323 ID is an alphanumeric name. It enables the administrator to know who is registered with the gatekeeper at a glance. This ID name can be entered into the <b>Manual Dial</b> screen as a way of making calls.
<b>H.323 Extension</b>	The H.323 Extension is a phone number or part of one (such as your extension number). This number is allocated by your system administrator. The format follows the E164 standard, and the length is user defined.
<b>Gatekeeper Mode</b>	Options are ON, AUTO and OFF. When ON is selected, the videophone looks for the Gatekeeper at the defined IP address. When AUTO is enabled, the <b>GK Addr</b> option is disabled, and the videophone looks to auto-register with the Gatekeeper. OFF must be selected when no Gatekeeper is present on the network.
<b>GK Addr</b>	The <b>Gatekeeper</b> address has the format of an IP address, and is entered when manual gatekeeper discovery is desired.
<b>NAT Addr</b>	Enter the external IP address of your videophone here if using NAT (Network Address Translation) in your router or firewall. Leave the field empty if you are using an H.323 aware firewall.

2. Press the  **enter** button twice to save the information selected in this menu.

## Configuring the Image Options

The Image Options menu configures various aspects of the video display.

### To configure the Image Options:

1. Press the  **menu** button, then press the number **4** key to display the Image Options menu.

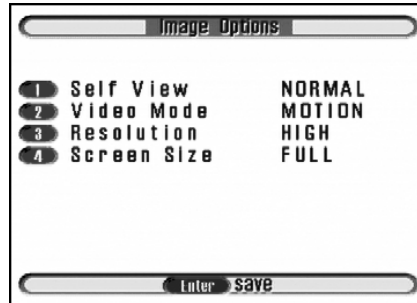

2. Use the number keys, or press the Up or Down arrow keys to select an option in the list.

<b>Self View</b>	Allows you to change the way video images are seen in PIP mode. Use the Right or Left arrow keys to select <b>NORMAL</b> or <b>MIRROR</b> . Select <b>NORMAL</b> to display the self view as the user will see the image at the remote end (Useful if using a document camera where text is displayed in the image). Select <b>MIRROR</b> to display the self view as a mirrored image (more comfortable for 'talking head' operation).
<b>Video Mode</b>	Allows you to customize the quality of the video received. Use the Right or Left arrow keys to select <b>MOTION</b> or <b>DETAIL</b> . Select <b>MOTION</b> to favor motion over detail in the received image (good for videoconferencing). Select <b>DETAIL</b> to favor detail over motion in the image (good for displaying text or detailed graphics using a document camera).
<b>Resolution</b>	Allows you to choose the default video resolution received at the start of each call. Use the Right or Left arrow keys to select <b>HIGH</b> or <b>LOW</b> . Select <b>HIGH</b> for high resolution "CIF" mode (352x288). Select <b>LOW</b> for low resolution "QCIF" mode (176x144).

<b>Screen Size</b>	<p>Allows you to set the default size of the video viewed on your TV.</p> <p>Use the Right or Left arrow keys to select <b>FULL</b> or <b>MEDIUM</b>. Select <b>FULL</b> for full screen size.</p> <p>Select <b>MEDIUM</b> for smaller than full screen size. This may be desirable for some applications using QCIF resolution, as a smaller active image may be more aesthetically desirable.</p>
--------------------	-----------------------------------------------------------------------------------------------------------------------------------------------------------------------------------------------------------------------------------------------------------------------------------------------------------------------------------------------------------------------------------------------------

3. Press the **✓enter** button twice to save the selections and to return to the Setup Menu.

## Configuring the Audio Options

The Audio Options menu allows you to configure various aspects of the audio sources.

### To configure the Audio Options:

1. Press the **☰menu** button, then press the number **5** key to display the Audio Options menu.

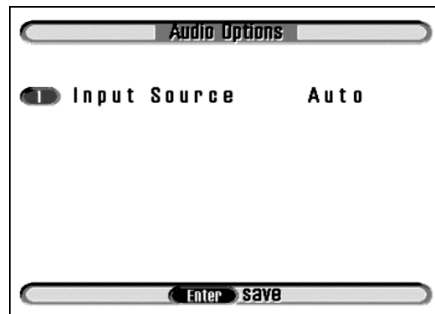

2. Press the number **1** key to select Input Source.

<b>Input Source</b>	<p>Use the Right or Left arrow keys to select <b>Line 1</b>, <b>Line 2</b> or <b>Auto</b> or <b>MIC</b>.</p> <p>Select <b>MIC</b> for the internal microphone.</p> <p>Select <b>Line 1</b> for the audio source connected to Audio In.</p> <p>Select <b>Line 2</b> for the audio/visual source connected to the Camera port.</p> <p>Select <b>Auto</b> for automatic selection. Note that Auto is not suitable for all instances. For instance, if you are using a Document camera, you will still want to talk, so select MIC.</p>
---------------------	-------------------------------------------------------------------------------------------------------------------------------------------------------------------------------------------------------------------------------------------------------------------------------------------------------------------------------------------------------------------------------------------------------------------------------------------------------------------------------------------------------------------------------------

3. Press the **✓enter** button twice to save the selections and to return to the Setup Menu.

# Making a Call

This chapter explains how to make a call. To make a call you can:

- Make analog calls (mm156 only) by lifting the handset
- Dial an IP extension number by pressing the speaker button.
- Manually call other IP videophones using an IP address, alias or E.164 number by pressing the start button twice.
- Use the Speed Dial menu to make any type of call by pressing the start button once.
- Make calls from the Dialed, Received or Missed calls list (*NOTE*: Caller ID details are not stored for Analog calls) by accessing the phonebook menu.

## Making Analog Calls (mm156 only)

### To dial manually with dial tone:

1. With the logo screen displayed, lift the handset or press the **Speaker** button. The screen displays the message, “Accessing, Please Wait.”
2. Wait for the dial tone and the “Ready to Dial” message.
3. Dial the number you wish to call. The number will be displayed as it dialed. The screen will display a message indicating a “Voice Only Call.” This will be shown through the duration of the call, or until the call is switched to video.
4. When the receiving party answers, a voice only call is established. The phone at the remote end displays, “Voice Only Call. Start Video.”

---

**Note:** You cannot make or receive (although the phone will still ring) a call when a menu is displayed. Exit to the idle screen to answer.

---

### To convert the call to a video call:

1. The receiving party presses the Start/Dial button. While the video is connecting, a message displays, “Connecting. Please Wait.” A yellow time-out bar will be displayed also. If this bar goes all the way across, then the connection drops and the unit goes back to idle. For most connections, the call will connect before the bar reaches half full. Typically, connecting takes around 12 seconds.
2. When the connection is complete a message states, “CareStation Connected.” You will then see an image of yourself in the middle of the screen with the message “Starting”. Starting typically takes around 6 seconds.
3. Once the call is fully connected, the self-view is cleared, and the audio and video from the remote side open. As soon as you can see the remote side, you may begin speaking.

## Calling an Extension number

You can call an extension number of another videophone within the same network as your videophone. The extension number is the last 2, 3 or 4 digits of the IP address, as entered in the phone book. You need to set the number of digits needed to be dialed to make a call in the Network Setup Menu. See “Intercom Dial” on page 14. *NOTE:* Extension dialing is only applicable for calls to other IP videophones and group systems.



### To call an extension number:

1. Press the speaker button and enter the extension number of the person you are calling.
2. The person you are calling needs to press the  **start** button to answer, unless they have set the Intercom Answer feature to Auto.

## Setting Intercom Answer

The Intercom Answer feature allows calls to connect automatically when an extension number is dialed.

### To set the Intercom Answer feature:

1. Press the  **menu** button on the key pad, then press the number **2** key to display the Communications Setup menu.
2. Press the number **7** key to highlight the Intercom Answer option.
3. Use the Right or Left arrow keys to select **AUTO**.
4. Press the  **enter** key twice to save the selections and return to the Setup Menu.

---

**Note:** If you do not want a video call to start automatically when your extension number is dialed, set Intercom Answer to **MANUAL**.

---

## Making a Call Using Manual Dialing

To make a manual dialed call:

1. From the idle screen or Setup Menu, press the  **start** button twice. The Manual Dial screen is displayed.

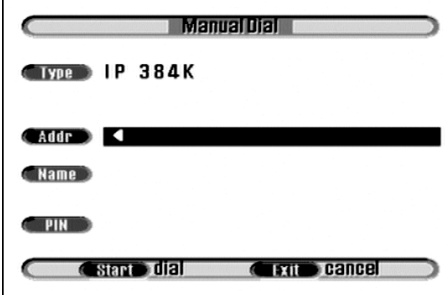

The screenshot shows the 'Manual Dial' screen. At the top, there is a title bar with the text 'Manual Dial'. Below the title bar, there are several fields and buttons. The first field is 'Type', which has 'IP 384K' selected. Below it is the 'Addr' field, which has a left arrow pointing to it. Below that is the 'Name' field, which is currently empty. Below the 'Name' field is the 'PIN' field, which is also empty. At the bottom of the screen, there are two buttons: 'Start dial' and 'Exit cancel'.

2. Select the required call type and bandwidth using the left & right arrow keys in the Type field. If you wish to call a standard telephone or mobile, select Analog.
3. In the **Addr** field, use the number keys on the key pad to enter the IP address you want to call. Use the \* key (located at the bottom left of the key pad) or enter a space using the Right arrow key to represent a period in the IP address.
4. Alternatively, instead of entering the IP address, you can enter the name in the **Name** field, *providing* Gatekeeper is enabled. You must enter this name exactly as it is stored in the system, such as "JOHNDOE". Adjust the case by pressing and holding the keys if necessary.
5. If the person you are calling requires PIN authorization, in the PIN field use the remote control to enter the PIN.
6. Press the  **start** button to dial your call.  
The message "Dialling x.x.x.x, User Found, Connecting" is displayed.
7. To end the call, replace the handset.



## Using Speed Dialing

You only need to press two keys to make a speed dial call provided that you have created a Phone Book entry. See “Setting up the Phone Book” on page 10.

### To make a speed dialed call:

1. Press the  **start** button.

The Speed Dial Menu appears showing the names of up to nine contacts already set up on page 1. (typical screen shown)



Use the Right and Left arrow keys to access additional contacts, if more than 9 entries have been made.

2. Press the number key that corresponds to the person you want to call.  
The videophone automatically dials the call for you.

## Dialed, Received and Missed Calls lists

Within Phonebook, there is a register listing Dialed, Received and Missed calls. This is applicable to IP calls only and does not support Analog calls.

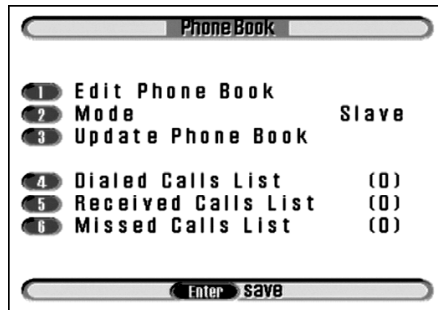

### To access the Dialed Calls List:

1. Press the  **menu** button, then press the number **1**, to display the Phonebook.

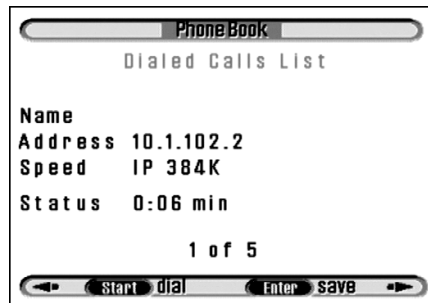

2. Press the number **4** key to display the **Dialed Calls List** (below).



3. Use the Right or Left arrow keys to select scroll through the list of Dialed numbers. The name, address, speed of connection and call duration (or status) are given.
4. Press the  **enter** button to save any of the numbers in the Phonebook, when you are prompted to give a name. Press the  **enter** button to save the changes.
5. Press Start to redial any of the numbers

### To access the Received Calls List:

1. Press the  **menu** button, then press the number **1**, to display the Phonebook.

2. Press the number **5** key to display the **Received Calls List** (below).

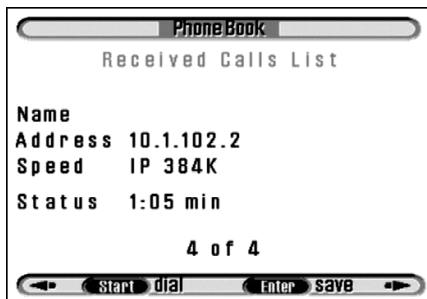

3. Use the Right or Left arrow keys to select scroll through the list of Received numbers. The name, address, speed of connection and call duration (or status) are given.

The numbers can be saved or dialed as for Dialed calls.

#### To access the Missed Calls List:

1. Press the  menu button, then press the number **1**, to display the Phonebook.
2. Press the number **6** key to display the **Missed Calls List** (below).

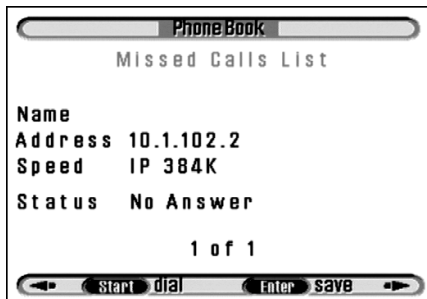

3. Use the Right or Left arrow keys to select scroll through the list of Missed numbers. The name, address, speed of connection and call duration (or status) are given.

The numbers can be saved or dialed as for Dialed calls.



## CHAPTER 4 Receiving a Call

This chapter explains how to receive a call. You can receive a call either:

- Manually
- Using the Auto Answer feature

### Receiving a Call

If your videophone is called by a remote user and Auto Answer is set to **OFF**, the following screen is displayed:



- Pick up the handset, **or**
- Press the  **start** button.

---



**Note:** If you are working with the menus and the phone rings you must exit the menus before you can answer the phone.

---

## Auto Answer

You can set the videophone to automatically answer a call after a specified number of rings.

### To set Auto Answer:

1. Press the  **menu** button on the key pad, then press the number **2** key to display the Communications Setup menu.
2. Press the number **2** key access network setup, and the **7** key to highlight the Auto Answer option.
3. Use the Right or Left arrow keys to select the number of rings you want to set. You can choose between **1 RING** and **8 RINGS** or **OFF**.
4. Press the  **enter** key twice to save the selections and return to the Setup Menu.

# CHAPTER 5 Changing Options During a Call

This chapter explains how to use the following function buttons on your videophone during a call:

- Volume
- Picture in Picture
- Privacy
- Snapshot
- Source
- Image

These buttons are accessed from the button panel on your videophone:

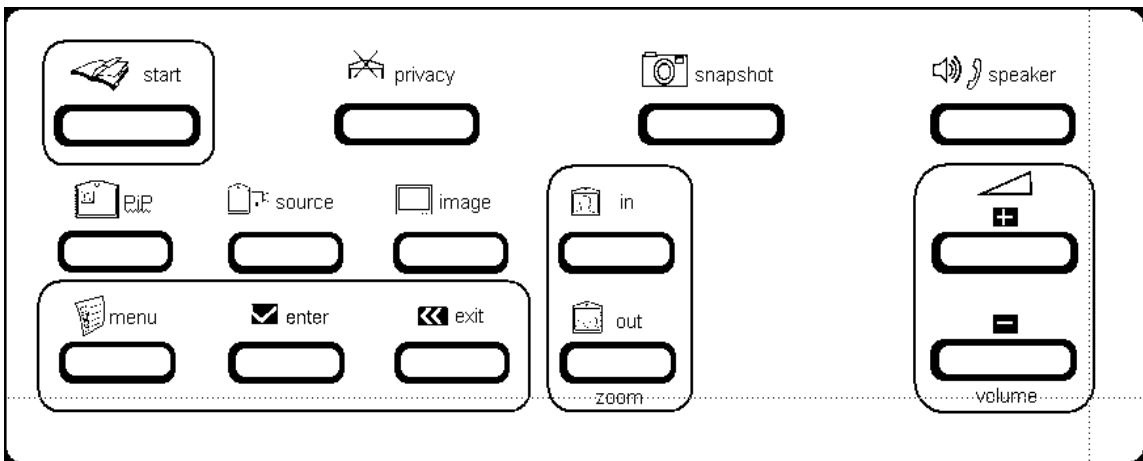

## Volume

The Volume function allows you to change the volume of the audio while a call is in progress.

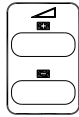

Press the **Volume Up** and **Down** buttons to adjust the volume of the incoming calls. A green status bar is displayed on the screen indicating the volume level.

## Picture in Picture





Picture in Picture (PiP) presents a mirrored self-view image, or the image from an external camera source within the video image you are viewing.

Press the  **PIP** button to activate Picture in Picture. The Picture in Picture window is displayed with a frame around it.





As long as it is outlined, you can control Picture in Picture using the following control keys:

<p>Change the size of the Picture in Picture window.</p>	<p>Use the  /  buttons.</p>
<p>Change the location of the Picture in Picture in the screen in the direction of the arrow key. You lose control of the PiP when you enter other modes.</p> <p>To regain control, press the  button again.</p> <p>To remove Picture in Picture, be sure that you have control (the yellow frame is displayed) and press the  button.</p>	<p>Use the <b>Arrow</b> keys.</p> 

## Privacy

The Privacy function is the same as the mute button on an ordinary telephone.

Press the  **privacy** button to stop all outgoing audio and video.

To resume the call, press the  **privacy** button a second time.

## Snapshot

The Snapshot function allows you to freeze the video image displayed on your screen so you can get a better view of an image. Press the  **snapshot** button during a call when you need to view a still shot of, for example, an object at the remote end.

When you press the  **snapshot** button, a small camera icon appears in the upper right corner of your screen.



To resume the call, press the  **snapshot** button again.

# Source

The Source function allows you to control the camera on the videophone both locally and at the far end. You can also control any pan/tilt/zoom cameras connected locally to the videophone and any pan/tilt/zoom cameras connected at the far end.

---

**Note:** This function is always active; default is control to the near end

---

## To engage camera control at the far end:

Press the  **source** button once to engage camera control at the far end. A transparent arrow pointing up appears on your screen.



This icon is displayed for 20 seconds, then disappears, but remains active.

The Source function allows you to control the camera(s) at the far end, if remote access is enabled at the far end.

## To engage camera control at the near end:

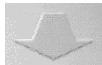

Press the  **source** button a second time to engage control at the near end. A transparent arrow pointing down appears on your screen.



This icon is displayed for 20 seconds, then disappears, but remains active.

The source function allows you to control the camera(s) at the near end.

Use the control keys to make changes at both the near and far end as follows:

Zoom the camera In or Out	Use the  /  buttons.
Use to digitally pan and tilt the internal camera image or to electronically control a pan/tilt/zoom camera which can be connected to Data Port 1 of the videophone.	Use the <b>Arrow</b> keys. 
Select a different camera	Use the number <b>1, 2, or 3</b> number keys

# Image

The Image function allows you to:

- Change the screen size.
- Set high or low resolution.
- Change the relationship between frames per second and the image resolution.



## To change the screen options:

1. Press the  **image** button.



A transparent TV icon is displayed and remains on until switched to another mode.

2. Use The Control keys to make changes:

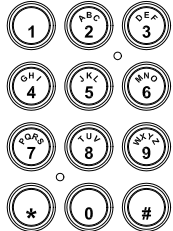
<p><b>Change the screen size on your LCD.</b> You may want to change image size, for example, when an external video source does not fit on the screen.</p>	<p>Use the  buttons.</p>
<p><b>Change the resolution of SENT video.</b> You may need to drop to low resolution during a call if you run out of bandwidth (and the speech becomes distorted). Or during a videoconference, low resolution may be required by the MCU. Change to high resolution using the Up arrow key, or select low resolution using the Down arrow key. The words “Low Resolution” or “High Resolution” are displayed on screen.</p>	<p>Use the <b>Arrow</b> keys.</p> 
<p><b>Motion versus resolution</b> Choose a value from 1 to 9 to set your preference for motion versus detail in the video image. Setting the value to 1 maximizes detail, while setting it to 9 maximizes motion. The default setting is 5.</p>	<p>Use the <b>Number</b> keys.</p> 



# Connecting Other Equipment

You can connect other equipment to your videophone including:

- TV set
- Second camera
- Pan, Tilt, Zoom camera
- Document cameras
- Video recorder (VCR)
- PC

---

**Warning:** Before connecting any equipment that was not supplied with your videophone, you must ensure that it is compatible. Contact your Black Box representative for advice.

---

## External Connectors

There are a number of external connectors on the back of your videophone which are detailed below.

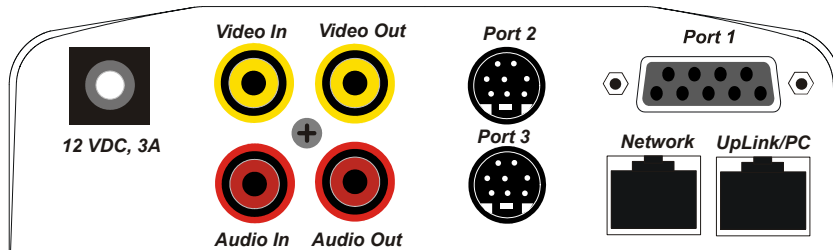

<b>Audio In</b>	Use with any line audio source, VCR or camcorder microphone. When used, set Input Source to Line 1.
<b>Audio Out</b>	Use with any line audio equipment, such as TV set, VCR or amplifier.
<b>Video In</b>	Use with any composite video source, such as a second camera or a VCR.
<b>Video Out</b>	Use with any composite video equipment, such as a TV set or VCR. It enables the picture to be displayed on both your videophone and a TV set.
<b>Port 1</b>	For RS-232 serial peripherals and PTZ cameras. DB9 female, DCE pinning, requires a straight pinned DB9 cable for connection to a PC.
<b>Port 2/Camera</b>	For RS-232 serial peripherals, and external cameras & microphones. Requires adaptor cable. Contact your Black Box Representative for information.
<b>Port 3/ Accessory</b>	For RS-232 serial peripherals, and future expansion modules. Requires adaptor cable.
<b>Power</b>	Power in connector to be used only with the power supply provided with your videophone.
<b>Network</b>	Use to connect to any 10 or 100 Mbps network hub or switch
<b>Uplink/PC</b>	Use to connect to your PC, allowing the videophone and PC to share a single network connection.

## Connecting a TV Set

Connecting your videophone to a TV set enables you to see the video picture on the TV screen and hear the sound from your TV loudspeaker.

The TV may be used as an alternative to the built-in screen and speaker, or you can use both at the same time.

### To connect a TV to your videophone:

- You need a pair of phono A/V cables.
- You need a TV with phono audio and video A/V inputs, or a SCART to phono adaptor.
  1. Connect one end of the standard A/V cable to **Audio In** on your TV and connect the other end to **Audio Out** on your videophone.
  2. Connect one end of the standard A/V cable to **Video In** on your TV and connect the other end to **Video Out** on your videophone.

---

**Tip:** Make sure you connect video to video and audio to audio.

---

## Using the TV

The picture from the videophone will appear on the TV screen as well as the videophone screen.



When using the videophone handsfree, sound will come from the TV speaker as well as from your videophone.

## Connecting Additional Cameras

You can connect up to two additional cameras such as a PTZ camera, either as an alternative or as an addition to the built-in camera.

You can use the A/V connections, the camera port, or the data ports on the back of the videophone, depending on what equipment you are connecting. Refer to the documentation supplied with your camera or contact your distributor for further information.

### To connect a camcorder to your videophone using A/V sockets:

- You need a pair of phono A/V cables.
- Follow any instructions provided with your camera when connecting the equipment.
  1. Connect the video output from the camera to **Video In** on your videophone.
  2. If the camera has a built-in microphone that you want to use, connect the camera's audio output to your videophone's **Audio In**.
  3. Press the  **menu** button to access the Setup Menu.
  4. Press the number **5** key to access the Audio Options menu, then press the number **1** key.
  5. Set the Input Source to **Line 1** using the Right or Left arrow keys.
  6. Press the  **enter** button twice to save the changes.

---

**Tip:** Make sure you connect video to video and audio to audio.

---

### To connect a Sony EVI or Canon VCC3/4 pan/tilt/zoom camera:

- Use the **Video In** A/V connection and use a **Data Port** on the back of your videophone to connect the camera control PTZ cable. Follow any instructions provided with your camera.

### Configure the Data Port Options:

1. Press the  **menu** button on your videophone to access the Setup Menu.
2. Press the number **6** key on your keypad to access the Data Port Options menu.



### If the camera is connected to Data Port 1:

1. Press the number **1**, or the arrow Up key to highlight the Data Port 1 option.
2. Use the Right or Left arrow keys to select **EXT CAM1**.
3. Press the **✓enter** button once.
4. Press the number **2**, and select Protocol which has become visible, and select the appropriate driver.
5. Press the **✓enter** button twice to save changes.

---

**Note:** Handshaking and Priority fields do not need to be changed. The default settings, NONE and LOW, are correct for this configuration.

---

### To connect other cameras:

- Refer to the manufacturer's documentation or contact Black Box for advice.

## Switching Between Video Sources

If you have additional video sources connected to your videophone, the far end can switch between these video sources and select the video they want to view during the call.

### To switch between video sources during a call:

1. Press the  **source** button once for far end control or twice for near end control.
2. Press a number key, **1**, **2** or **3** depending on the video source you wish to view.

---

**Note:** **1** is the Internal Camera, **2** is the phono connector (Video In) and the MINIDIN 8 camera port is your number **3** video source. Contact Black Box for more information.

---

## Setting Camera Video Presets

Up to 9 camera presets can be configured in the videophone. This enables you to select various camera positions from any of the three video sources. For instance, if the unit is used for videoconferencing, a PTZ camera may be set as the default.

A preset configuration is a combination of a specific camera and its settings. Video presets are set in the Camera Video Setup menu. See Setting Video Presets on the next page.

You can also set presets for remote cameras if you have a supervisor PIN for the remote videophone that the camera(s) are connected to. In a similar manner, users of a remote unit can set and/or amend the video presets of your local videophone, provided you set up a Supervisor PIN and let them have the number. Setting a Supervisor PIN is covered in Chapter 7 - Advanced Options.

## Setting Video Presets

### To set your local video presets:



1. Press the  menu button, then press the number **3** key to display the Camera Video Setup menu.

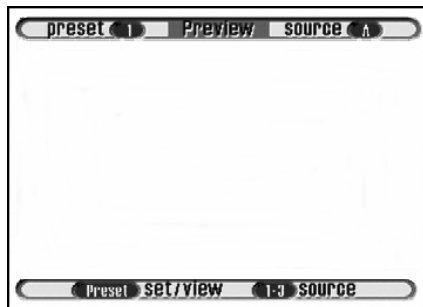

2. Press the number **1** key - Preview/Set Preset. After a pause, the screen displays showing your image taken by the internal camera.



### To program the Preset:

1. Press a number key between **1** and **3** to select the camera source to use for your preset. The text at the top right of the screen displays the selected video source for a few seconds. (A = Input Source 1 from the built-in camera, B = Input Source 2 from Video In, C = Input Source 3 from the Camera port MINIDIN connector).
2. Use the  Zoom In and  Zoom Out buttons and the arrow keys to pan, tilt and zoom that camera to the view you want to save.

3. When you are satisfied with the view for this preset, press the round arrow center button key twice followed by a number key (between 1 and 9) to save your preset.

**Note:** You can use the **⏪exit** key to go back and readjust the video preset if required.

The top left of the screen shows the number you have assigned to the preset; the top right of the screen shows the source.

4. To set further presets, repeat steps 1 to 3 as many times as necessary. You can define up to nine presets.
5. Press the **✓enter** button twice to save and to return to the Camera Video Setup Menu.

---



**Note:** If you have more than one preset defined for a camera, choose which of these presets is the Default Preset for that camera. The Default Preset is the view to which the camera automatically returns at the beginning of a call.

---

## Setting the Default Preset



If you have more than one camera, choose which of these presets is the Default Preset. The Default Preset is the view that is displayed at the beginning of each call.

### To set the Default Preset:

1. Press the  **menu** button, then press the number **3** key to display the Camera Video Setup menu.
2. Press the number **2** key to highlight Default Preset.
3. Use the Right or Left arrow keys and select number between **1** and **9** to set the Default Preset.
4. Press the  **enter** button twice to save your changes and return to the Setup menu.

## Viewing Video Presets

### To view near end presets when not in a call:

1. Press the  **menu** button, then press the number **3** key to display the Camera Video Setup menu.
2. Press the number **1** key to display Preview window.
3. Press the Arrow Center button on the key pad.  
At the bottom right of the screen you see: “1-9 view”.
4. Choose a number between **1** and **9** to view that preset.
5. To view another preset repeat steps 3 and 4.
6. When you have finished viewing presets, the  **enter** button twice to return to the Setup Menu.

### To view camera presets during a call:

1. Press the  **source** button once for Far End control or twice for Near End control.
2. Press the round arrow center button.
3. Press a number key between **1** and **9** depending on the video preset you wish to view.

## Allowing Remote Control of Video Cameras

The Remote Access feature allows others to remotely control your camera video sources. Remote Access **ON** enables remote parties to change camera sources, and pan, tilt, and zoom your camera. Remote Access **OFF** prevents remote parties from changing the current video setup.

1. Press the  **menu** button, then press the number **3** key to display the Camera Video Setup menu.
2. Press the number **3** key to highlight Remote Access.



<b>Remote Access</b>	Use the Right or Left arrow keys to select <b>ON</b> or <b>OFF</b> . Select <b>ON</b> to allow others to remotely control your camera(s). Select <b>OFF</b> to not allow remote users to control your camera(s).
----------------------	------------------------------------------------------------------------------------------------------------------------------------------------------------------------------------------------------------------

Press the  **enter** button twice to save the selections and to return to the Setup Menu.

## Connecting a Video Recorder (VCR)

You can connect a VCR to your videophone and play pre-recorded video clips (including the soundtrack) during a video call.

### To connect a VCR to your videophone:

- You need a pair of phono A/V cables.
  1. Connect one end of the phono A/V cable to **Audio In** on your VCR and connect the other end to **Audio Out** on your videophone.
  2. Connect one end of the phono A/V cable to **Video In** on your VCR and connect the other end to **Video Out** on your videophone.
  3. Press the  **menu** button to access the Setup Menu.
  4. Press the number **5** key to access the Audio Options menu, then press the number **1** key to highlight the Input Source field.
  5. Set the Input Source to **Line 1**, then press the  **enter** button twice to save the changes.

**To play the video clip:**

1. While in a video call, press the  **source** button twice for Near End control.
2. Press the number **2** key to switch the video source to the VCR.
3. Press **Play** on the VCR to start playing the clip.

The person at the far end sees and hears the video clip.

**When the clip has finished:**

Press **Stop** on the VCR.

## **Additional Information**

Information about connecting peripheral equipment can be obtained from Black Box technical support.

Contact your Black Box for more information on compatible or approved equipment that can be used with your videophone

## CHAPTER 7      **Advanced Options**

This chapter covers options that are changed infrequently:

- User IDs and PIN numbers for security. These are set in the User Options menu.
- Data options. This enables three auxiliary data ports to be configured for sending data.

### **Changing the User Options**

#### **User IDs**

The User ID is an optional feature that displays descriptive text at the bottom of the remote screen during a call. You can enable it for incoming calls in the User Options Menu. See “Setting up the User Options” on page 12.

#### **Using a Security PIN**

The security PIN (Personal Identification Number) is an optional feature that prevents an incoming call from being received unless the person calling knows the correct PIN.

The PIN Mode field in the User Options menu allows you to turn use of your PIN on or off. If your PIN mode is ON, the calling party must enter your PIN to establish the video call.

## Setting up a Supervisor PIN

The Supervisor PIN option prevents unauthorised users from remotely changing the video presets on the unit using a confidential PIN number.

The Supervisor Mode field in the User Options menu allows you to turn the Supervisor PIN **ON** or **OFF**. If the PIN mode is ON, the calling party must enter the Supervisor PIN to change the video presets from a remote location during the call.

---

**Note:** If you are a calling a unit that has both the Security PIN and Supervisor PIN, enter the Supervisor PIN when dialing the unit. The Supervisor PIN overrides the Security PIN.

---

## Setting up the User Options

To access the User Options menu:

1. Press the  **menu** button, then press the number **7** key to display the User Options menu.

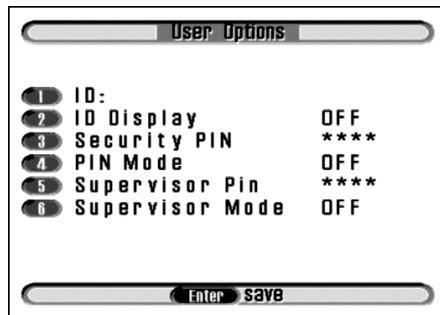



2. Use the number keys to select an option in the list.

<b>ID</b>	<p>Enter your user ID using the number keys on the key pad. Press a number repeatedly to scroll through the letters it represents. When the correct letter is displayed, press the Right arrow key to move to the next space and be able to enter another letter.</p> <p>Press the Left arrow key to delete the last letter.</p> <p>Press <b>ENTER</b> to save the User ID.</p> <p>As an alternative to this option, if you have configured an H.323 name in the Gatekeeper menu, this will be displayed on call initiation.</p>
<b>ID Display</b>	<p>Allows you to control whether the ID of the remote user is displayed on your TV screen.</p> <p>Select <b>ON</b> to display the remote user's ID for the first 8 seconds of the call.</p> <p>Select <b>HOLD</b> to display the remote user's ID for the entire call.</p> <p>Select <b>OFF</b> to not display the remote user's ID.</p>
<b>Security PIN</b>	<p>Use the number keys on the key pad to enter a four digit PIN.</p>
<b>PIN Mode</b>	<p>Select <b>ON</b> to allow a call to be received only if the correct PIN is entered.</p> <p>Select <b>OFF</b> to receive a call without having to enter a PIN.</p>
<b>Supervisor PIN</b>	<p>Use the number keys to enter a four digit PIN.</p>
<b>Supervisor Mode</b>	<p>Select <b>ON</b> or <b>OFF</b>.</p> <p>If <b>ON</b> is selected the correct PIN must be entered for a call to be received. The remote user can then change video presets during the call.</p> <p>If <b>OFF</b> is selected a PIN is not required in order to receive a call.</p>







3. Press the **✓enter** button twice to save the changes and return to the Setup Menu.

## Using the Supervisor PIN Mode During a Call

You can change Far End preset if the following are true:

- The unit being called has Supervisor Mode turned **ON**.
- The unit being called has Remote Access turned **ON**.
- The correct Supervisor PIN is entered.

To set up video presets on a remote videophone:

1. Press the  **menu** button, then press the  **start** button twice. The Manual Dial screen is displayed.
2. Use the number keys to enter the IP address in the **Addr** field of the party you wish to call.
3. Use the Down arrow key to highlight the **PIN** field. Use the number keys to enter the four digit Supervisor PIN.
4. Press the  **start** button to dial your call.
5. When the call is connected, press the  **source** key. The transparent arrow facing away from you indicates FAR end camera control. The transparent S at the bottom left corner of the screen indicates Supervisor Mode.
6. Press a number key between 1 and 3 to select the video source you wish to view.
7. Use the  **zoom in** and  **zoom out** buttons along with the arrow keys to pan/tilt/zoom the view you wish to save.
8. Press the round arrow center button twice followed by a number key, to save as your preset.
9. Repeat steps 7 to 9 as necessary.

## Using the Data Ports

The videophone unit is equipped with three auxiliary data ports labeled **Port 1**, **Port 2** and **Port 3**. The data ports are configured in the Data Options menu.

The data ports can be used for data transmissions in a variety of applications ranging from pan/tilt/zoom (PTZ) cameras, PC-to-PC data transfer, external third party peripheral control, or for telemetry data transmission, during a video call.

---

### Notes:

1. The serial connection does not interfere with the normal video and audio operation of the videophone
  2. The remote videophone must also be set up for data transfer. The same settings must be used on both ends.
- 

## Configuring the Data Ports

To configure the Data ports:

1. Press the  **menu** button, then press the number **6** key.

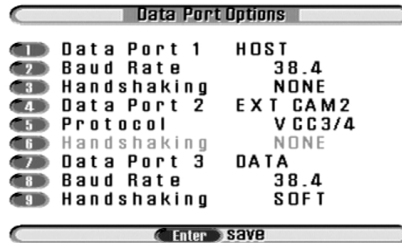

2. Use the number keys to select an option in the list.

<p><b>Data Port 1</b></p>	<p>Use the Right and Left arrow keys to display the correct option for the port:          Select <b>EXT CAM1</b> for an RS-232 connection to an external pan/tilt/zoom camera. Press the <b>ENTER</b> key to make this selection. You will notice a change in the menu options.          Press the number <b>2</b> key to select <b>Protocol</b>. Use the Right and Left arrow keys to scroll through the options and select external camera driver you require. Select either <b>Sony EVI</b> or <b>VCC3/4</b> depending on the camera you have.          Select <b>DATA</b> for an application that passes data, and the data channel is open when the call connects. This is the option to use if you are connecting an alarm system.          Select <b>EXT DATA</b> for a data channel that is closed when the call begins and can be turned off and on by the user during the call.          Select <b>HOST</b> if you are using a PC program such as HyperTerminal.          Select ---- to disable the port.</p>
<p><b>Baud Rate</b></p>	<p>Set the Baud Rate using the Right or Left arrow keys. This field determines the data rate at which the data port operates and varies according to equipment.</p>
<p><b>Handshaking</b></p>	<p>Select <b>SOFT</b>, <b>THRU</b> or <b>NONE</b> using the Right or Left arrow keys.          The Handshaking field setting determines whether the data port will use Handshaking for flow control to the local connection.          If <b>SOFT</b> is selected, the videophone sends X-ON and X-OFF characters to control the flow of information over the video call. Soft Handshaking is needed when the local connection may be set for a baud rate which is equal to or greater than the video connection rate, or when the equipment at the local end may not always be able to keep up with the incoming data transfer.          If <b>THRU</b> is selected, the videophone monitors the RTS/CTS line and transmits this line to the remote location, allowing for a pass through of the RTS/CTS line used by NetMeeting and any other program/device that uses these lines for handshaking.          Select <b>NONE</b> if no Handshaking is required.</p>

<b>Data Port 2</b>	This item sets the mode for Data Port 2 (Camera). The options available are the same as on Data Port 1, but the options available at any one time are dictated by the option selected on Date Port 1.
<b>Baud Rate</b>	This item sets the Baud Rate for Data Port 2.
<b>Handshaking</b>	This item sets the handshaking for data port 2. The operation is as detailed for data port 1.
<b>Data Port 3</b>	This item sets the mode for Data Port 3 (Accessory). The options available are the same as on Data Port 1, but the options available at any one time are dictated by the option selected on Date Port 1.
<b>Baud Rate</b>	This item sets the Baud Rate for Data Port 3. The maximum Baud rate for port 3 is 38.4 kbps.
<b>Handshaking</b>	This item sets the handshaking for Data port 3. The operation is as detailed for data port 1.

3. Press the **✓enter** button twice to save the changes to this menu screen and to return to the Setup Menu.



# Information and Diagnostics

This chapter describes the Information and Diagnostics screens. The Information and Diagnostics screens are for information only. You cannot change any values.

## The Information Screen

The Information screen shows:

- Customer Service number. Refer also to the Product Support page at the front of this User Guide, for the relevant Customer Service information for your location.
- The software version of your videophone. You will need to quote the software version if you contact Black Box Technical Support.
- The serial number of your videophone. You will need to quote the serial number if you contact Black Box .

**To display the Information screen (typical screen shown below):**

1. Press the  **menu** button, then press the number **8** key.

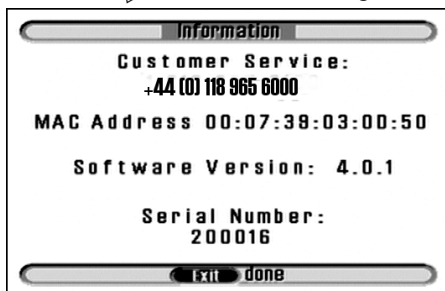

2. Press the  **exit** button to return to the Setup Menu.

## Diagnostic Information

The diagnostics screen shows information about the last call and provides current network statistics. This information may be useful when evaluating call times or network conditions.

### To display the Last Call Report:

1. Press the  **menu** button, then press the number **9** key to display the Diagnostics menu.

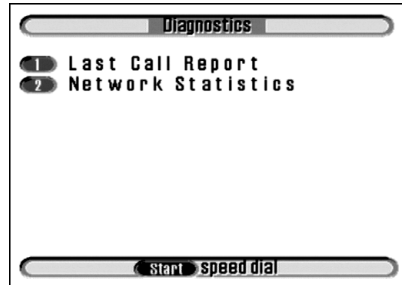

2. Press the number **1** key to access the Last Call Report.

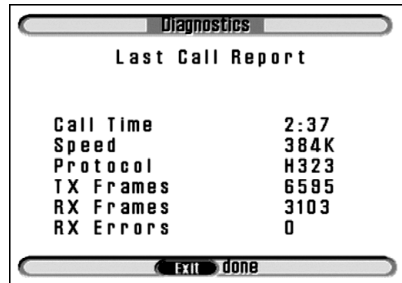

The following fields are displayed:

<b>Call Time</b>	The length of the call.
<b>Speed</b>	The speed of information transfer in bytes per second.
<b>Protocol</b>	The protocol you are using for the call e.g. Analog, Packet Buddy, H.323, H.324.
<b>TX Frames, RX Frames</b>	These fields are useful when the videophone is used for videoconferencing. They show the number of frames transmitted and received allowing the percentage error rate to be calculated.
<b>RX Errors</b>	Shows the number of protocol frames received over the network with an error.

3. Press the  **exit** button to return to the Diagnostics menu.



**To display the Network Statistics screen:**

1. From the Diagnostics menu, press the number **2** key to access Network Statistics.

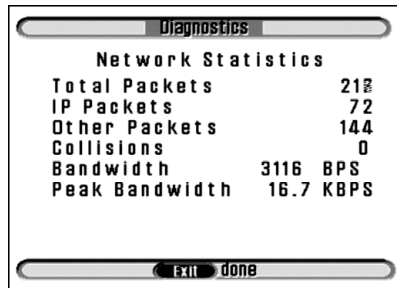

The following fields are displayed:

<b>Total Packets</b>	An accumulated count of all network packets.
<b>IP Packets</b>	An accumulated count of IP packets.
<b>Other Packets</b>	An accumulated count of other protocol packets, i.e. IPX, NetBEUI.
<b>Collisions</b>	Current count of network collisions.
<b>Bandwidth</b>	Current network bandwidth being utilized.
<b>Peak Bandwidth</b>	Peak bandwidth utilization.

2. Press **◀exit** button to return to the Setup Menu.



# Troubleshooting

If you experience difficulties with the operation of your videophone, we recommend the following course of action.

- Check all the connections and verify the basic operation of the components of the installation, power to the system and your network.
- Review this User Guide to verify the proper setup and operation of the system.
- Consult the following table which describes some of the most common difficulties encountered with the operation of the unit, and follow any relevant advice for solving your problem.
- Carefully check the power and wiring for all external cameras used in the system and any other peripheral or video monitor used. Many typical problems, not described below, are usually related to faults with the additional equipment which comprise a complete installation or when this equipment is configured incorrectly.
- If your problem is still not resolved, contact Black Box Technical Support. Refer to the Product Support page at the front of this User Guide.

## General Maintenance

No specific maintenance is required for your videophone.

## Troubleshooting Tips

Symptom	Probable Cause(s)	Solution
Videophone does not power up: Indicator LED is off.	No AC power to the 12VDC Power Adapter, or no DC Power to the system.	If you are using the supplied AC adapter, check the AC power supply for 120VAC or 240VAC as indicated. If directly powering the unit from an external DC supply, check the alternative supply for proper operation and 10-18 VDC.
When making calls the unit reports “Dialing” but does not connect.	There may be a cable fault between the unit and the network hub or switch.	Check the network line by viewing the LEDs on the network ports. A green LED indicates a good network connection. Try a different cable and check that the cable is connected to the ‘Network’ port if the light is off.
When making calls the unit reports “Dialing” but does not connect.	There is no route to the other device, or the firewall may be blocking the transmission path between devices.	Check the IP configuration. (IP address, subnet mask, default gateway). If calling through a firewall contact your network administrator.
Units connects but no video and/or audio.	A firewall is blocking the video/audio streams.	Create a DMZ for both videophones, or unblock the following ports in the firewall for calls to/from the videophone. 1720, 5000-5010. Set the UDP port address to 5000.
Unable to go to video.	Supervisor PIN was not provided.	Contact Black Box Technical Support for advice.
After connecting to a remote system, you are unable to control or change the camera inputs.	The Remote Access menu item has not been set to ON in the Camera Video Setup menu.	Check the settings in the Camera Video Setup menu and make sure Remote Access is ON.

## CHAPTER 10 Technical Data

This chapter contains the technical specification and the regulatory and safety information for the mm146 and mm156 videophones.

<b>ITU Recommendations Supported</b>	
ITU-T	H.324, H.323
Video	H.263, H.261
Audio	G.723, G.711, G.722
Control Protocol	H.245

<b>Video Resolution</b>	
CIF	352 x 288 pixels, 15 fps
QCIF	176 x 144 pixels, 30 fps

<b>Display</b>	
LCD Monitor	5" Color
Local view Picture-in-Picture	
Snapshot Mode	Freeze Input to Encode

<b>Audio and Video Inputs</b>	
Audio Input	1 Line in RCA Phono
Video Input	1 Composite RCA Phono, PAL or NTSC
Peripheral camera port	MiniDin-8

<b>Audio and Video Outputs</b>	
Audio Output	1 Line out RCA Phono
Video Output	1 Composite RCA Phono PAL or NTSC

<b>Internal Camera</b>	
Image sensor	1/3" Color
Lens	f1.6
Manual Tilt	+25° / -2°

<b>Full Duplex Audio Processing</b>	
Handset or Handsfree Speakerphone Modes	
Adaptive Sub-band Echo Cancellation	
Automatic Gain Control	
Internal Speaker	
Internal Microphone	

<b>External PTZ Camera Control</b>	
3 Serial Data RS-232/V2.4 1.2 to 115.2kbps	
Connector	9 way D-type Female, DCE 8 pin Mini-DIN Female, custom pinning.
PTZ Drivers Supported	Canon VCC4, Sony EVI-D100

<b>Security Features</b>	
Secure PIN access to video and speech calls	
Secure PIN access to configuration	

<b>GUI/ Software Features</b>	
Intuitive Graphical User Interface	Using key pad for set up and dialing
Downloadable Phone Book	From Master Phone
Speed-Dial Phone Book	50 Entries
Remote Camera Control	(External PTZ)
Picture in Picture Display	Moveable, Sizable
Snapshot Mode	Freeze Input
Auto Connect Persistent Dial	Sequential List
Digital Pan/Tilt/Zoom	3x zoom
On-screen Diagnostics	Call Duration Quality
Downloadable Software Updates	Via IP Network or RS-232 Interface

<b>Network</b>	
Ethernet Network Interface	Dual 10/100 Ethernet
IEEE802.3 Ethernet Controller	
Internet Protocol (IP)	
User Datagram Protocol (UDP)	
Configurable IP port addressing for fire wall compatibility	
Proprietary Packet Buddy Protocol for transmission over non-QoS networks	
H.323 v. 3.0	

<b>Power</b>	
DC input	12VDC
Consumption	<22W Active, <5W Standby
UL/CSA/EN 60950 Listed AC adapter	100-240 VAC 50/60 Hz

<b>Physical</b>	
Dimensions	7" H x 8.25" W x 9.85" D, (180mm H x 210mm W x 250mm D)
Weight	1.2 kg

<b>Environmental</b>	
Operating Temperature	0° to 40° C
Non-operating Temperature	-40° to 70° C
Humidity	5% to 95%

<b>Packing</b>	
Individual Corrugated Carton	19.5" H x 10" W x 4" D, (275mm H x 310mm W x 310mm D)



## Regulatory Notices

Any changes or modifications to this equipment (and/or its operational software) not expressly approved by the manufacturer may void the telecoms and/or safety approvals for operation of this equipment.

## Power Supply Requirements

The mm146 and mm156 videophone models require a 12v dc supply capable of delivering up to 2A. Any power supply used with the videophone *must meet the requirements of safety standard IEC / EN 60 950 or UL equivalent*. The unit is not designed for outdoor use or installation and must be protected from water / rain etc.

## Supplied Power Supply Adapter! Exposing Risks of Electric Shock!

*Under no circumstances must you attempt to dismantle the supplied ac adapter.* There are no user serviceable parts inside and exposing the interior places the user at risk of serious electric shock. If you suspect a fault, contact your supplier for a new adapter.

Should the power supply adapter become damaged (possibly via an impact) *do not touch the adapter unit* but turn off the power supply. Only when the power is switched off or isolated, remove the unit from the power supply socket. *Do not re-use the damaged adapter* instead, contact the supplier for a new one. This note also applies to damaged power supply cords and plugs.

## Equipment Case

*Do not attempt to dismantle the main enclosure.* There are no user serviceable parts inside. The inside of the unit contains delicate components which may be damaged or destroyed through user contact and static discharges.

Contact with parts connected to the telecom network may result in an electric shock, however the voltage levels are deemed non-fatal.

## Regulatory Safety Statements

As required by International and European safety standards IEC and EN 60 950, the various connections to / from the mm146 meet the following safety definitions:

Connection	Definition	Notes
Power supply plug	Hazardous Voltage	Should the power supply plug or associated cable and power supply unit become damaged, do not connect to the power supply. If connected, turn off the supply before handling, then disconnect the plug. In the event of damage, contact your dealer for a replacement power supply unit.
Power supply outlet lead and plug	SELV (Safety Extra-Low Voltage)	For connection from the power supply unit to the POWER connector of the mm146. Safe to touch by the user.
POWER connector	SELV (Safety Extra-Low Voltage)	For connection of the power supply unit. Safe to touch by the user.
AUDIO and VIDEO connectors	SELV (Safety Extra-Low Voltage)	For interconnection of other audio and video equipment. Safe to touch by the user.
DATA connectors	SELV (Safety Extra-Low Voltage)	For computer type connections. Safe to touch by the user.
EXP (mini DIN)	SELV (Safety Extra-Low Voltage)	To expand the system A/V I/O. All devices connected directly or indirectly to this port must be SELV.
Network connector (IP)	SELV (Safety Extra-Low Voltage)	Normally an IP port is safe to touch by the user. If however you are indirectly connected to a network having TNV status, check the installation instructions for the intermediate equipment (Terminal adapter, xDSL modem etc.) to ensure the IP port remains SELV status.

---

**Notes:**

1. The table on the previous page provides regulatory safety information. It is not intended to explain how to set up and use the product. Before making any connection to the product please ensure that you have read and understood the contents of this User Guide.
  2. In terms of ensuring continued protection against electric shock, SELV (Safety Extra-Low Voltage) status connections must only be interconnected to other apparatus having SELV status ports.
  3. As outlined in 2 (above) with the exception of the power supply plug and ethernet connections, all connections made to this equipment must be SELV status.
  4. The interconnection of ports of differing electrical safety status is likely to result in a hazard and possible risk of electric shock.
  5. If you have any doubt about the safety or suitability of other equipment to be connected, please refer to a qualified electrical engineer.
- 

### **Industry Canada ICES-003 / NMB-003**

This Class B digital apparatus complies with Canadian ICES-003.

Cet appareil numérique de la classe B est conforme à la norme NMB-003 du Canada.

### **FCC Part 15 (USA)**

This equipment has been tested and found to comply with the limits for a Class B digital device, pursuant to Part 15 of the FCC Rules. These limits are designed to provide reasonable protection against harmful interference in a residential installation. This equipment generates, uses, and can radiate radio frequency energy and, if not installed and used in accordance with the instructions, may cause harmful interference to radio communications. However, there is no guarantee that interference will not occur in a particular installation. If this equipment does cause harmful interference to radio or television reception, which can be determined by turning the equipment off and on, the user is encouraged to try and correct the interference by one or more of the following measures:

- Reorient the receiving antenna.
  - Increase the separation between the equipment and the receiver.
  - Connect the equipment to an outlet on a circuit different from that on which the receiver is connected.
  - Consult the dealer or an experienced radio/TV technician for help.
- Use of a shielded cable is required to comply with Class B limits of Part 15 of FCC Rules.

## **FCC Part 68 (USA)**

This equipment complies with Part 68 of the FCC rules. The FCC registration number for this equipment can be found on a label affixed to the underside. If requested, this information must be provided to the telephone company.

An FCC compliant telephone cord and modular plug is provided with this equipment. This equipment is designed to be connected to the telephone network or premises wiring using a compatible modular jack which is Part 68 compliant.

If the equipment causes harm to the telephone network, the telephone company will notify you in advance that temporary discontinuance of service may be required. But if advance notice is not practical, the telephone company will notify you as soon as possible. Also, you will be advised of your right to file a complaint with the FCC if you believe it is necessary.

The telephone company may make changes in its facilities, equipment, operations or procedures that could affect the operation of the equipment. If this happens the telephone company will provide advance notice in order for you to make necessary modifications to maintain uninterrupted service.

If trouble is experienced with this equipment and for repair or warranty information please contact Black Box Customer Services. Refer to the Product Support page at the front of this User Guide. If the equipment is causing harm to the telephone network, the telephone company may request that you disconnect the equipment until the problem is resolved.

The equipment can not be used on public coin phone service provided by the telephone company. Connection to party line service is subject to state tariffs. (Contact the state public utility commission, public service commission or corporation commission for information.)

- This equipment is hearing-aid compatible

# Supported IP Networks and Operation

This Appendix discusses the typical network configuration that is supported and explains how the videophone operates on a LAN and over the Internet. This section will touch on many concepts of both Ethernet and IP based networks. A basic knowledge of these concepts is highly recommended as they are beyond the scope of this User Guide.

## Basic Operation

mm146 and mm156 models allow for up to 384kbps of IP based video over 10 or 100 Mbps UTP Ethernet connections. This allows the use of existing networks and Internet connections to supply high quality video transmission without the long distance expense of a regular ISDN call.

## Basic Network Configuration

The videophone supports a 10 or 100 Base-T connection over IP based networks using static and dynamic (DHCP) settings for IP address and subnet mask. This allows users to make calls on a local network from one IP address to another. There is support for a default gateway, IP port mapping and/or port forwarding. This concept is discussed below in the Internet Connectivity section. Using the same local area network (LAN) is the easiest way to configure two IP videophone systems (plug both systems into a 10Mbps network hub/switch).

Give both systems a unique IP address and the same subnet mask:

- Box A IP address = 10.1.20.1, subnet mask= 255.255.0.0
- Box B IP address = 10.1.20.2, subnet mask= 255.255.0.0

# Internet Connectivity

The mm146/mm156 supports a variety of different network topologies, depending on your requirements or installed infrastructure. Use the flowchart below to decide the best configuration for your network.

## Step 1 - Configuration flow chart

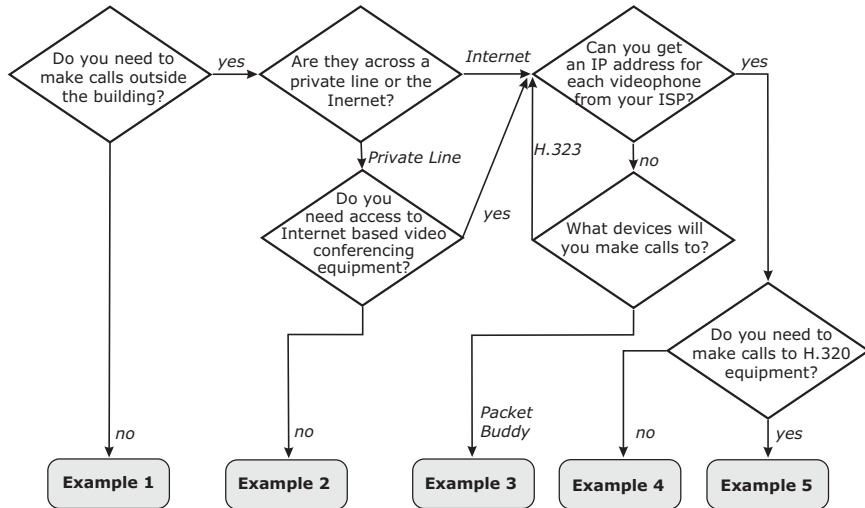

## Example 1 - configure your IP Videophone for use on the local network

IP Address 192.168.1.1  
Subnet Mask 255.255.255.0



IP Address 192.168.1.2  
Subnet Mask 255.255.255.0



1. Connect videophone to network.
2. Obtain internal IP addresses from your network administrator.
3. Obtain the subnet mask from your network administrator.
4. Configure IP address and subnet mask into phone.
5. You can now make calls.

## Example 2 - configure your IP videophone for use on a private network

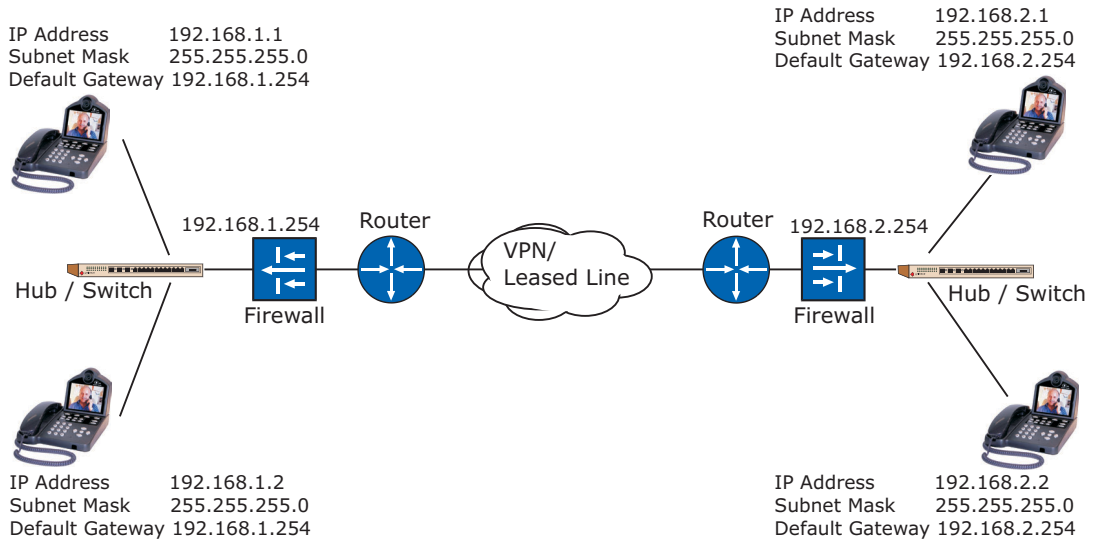

**Note:** Because the videophones are used internally, no external IP address is required. You may need to unblock ports 1718, 1719 1720, 5000 - 5010 in the firewall.

## Example 3 - configure your IP Videophone for use over the Internet

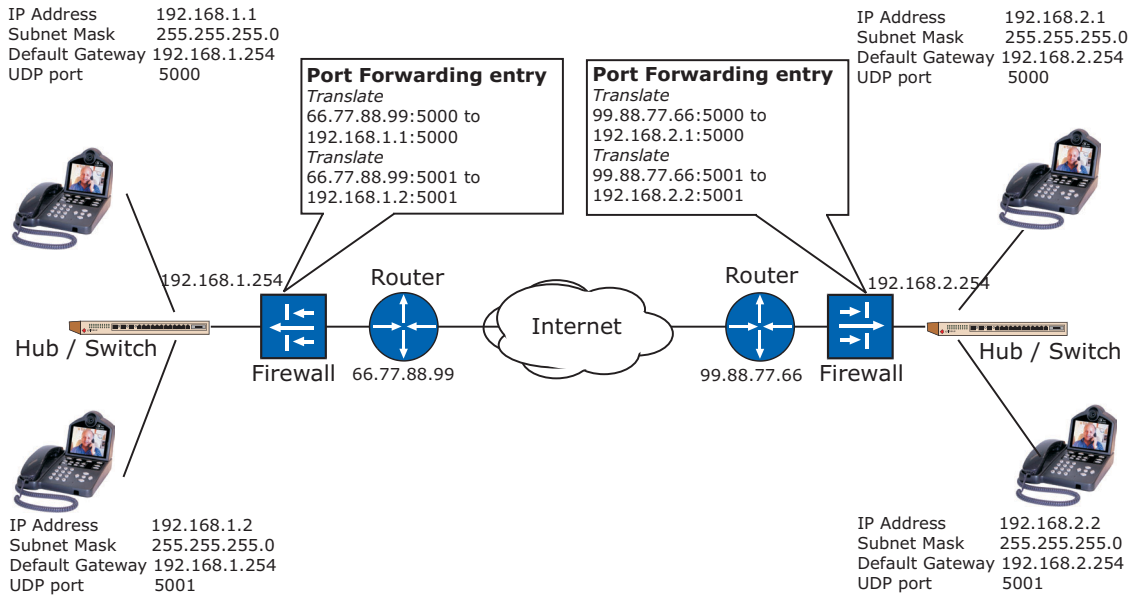

**Notes:** Callers dial the external IP address of the firewall appended by the port number. The firewall will be unblocked by creating the static network address translation. H.323 calls originating outside the firewall are not supported (MMTPB only).



## Example 4 - Calls between mm146/156 and H.323 equipment over the Internet.

IP Address 192.168.1.1  
 Subnet Mask 255.255.255.0  
 Default Gateway 192.168.1.254

IP Address 192.168.2.1  
 Subnet Mask 255.255.255.0  
 Default Gateway 192.168.2.254

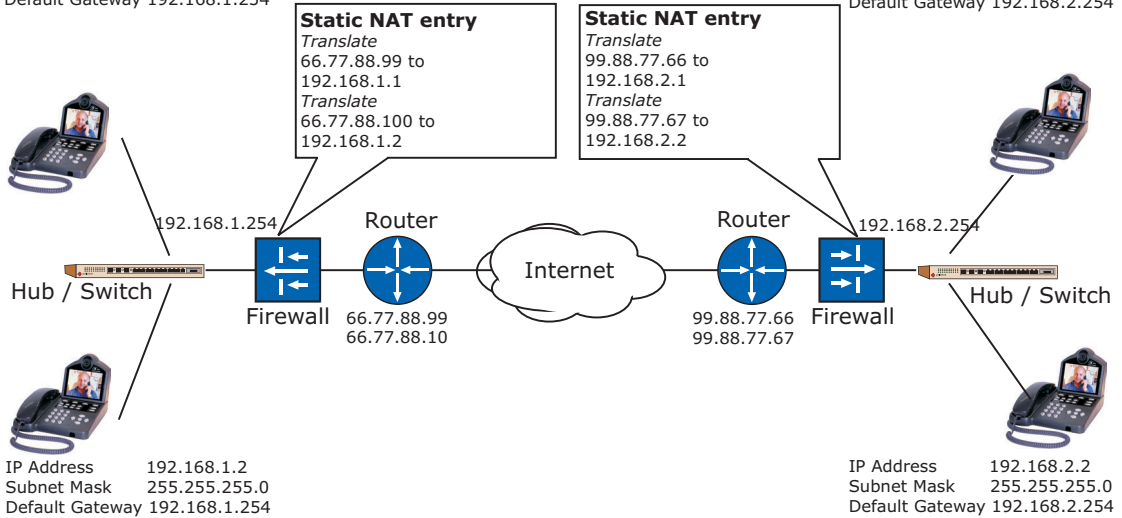

**Notes:** An external IP address is required for each videophone.  
 You may need to unblock ports 1719 - 1720, and 5000 - 5010 in the firewall.

## Example 5 - Interfacing with H.320 and H.323 equipment.

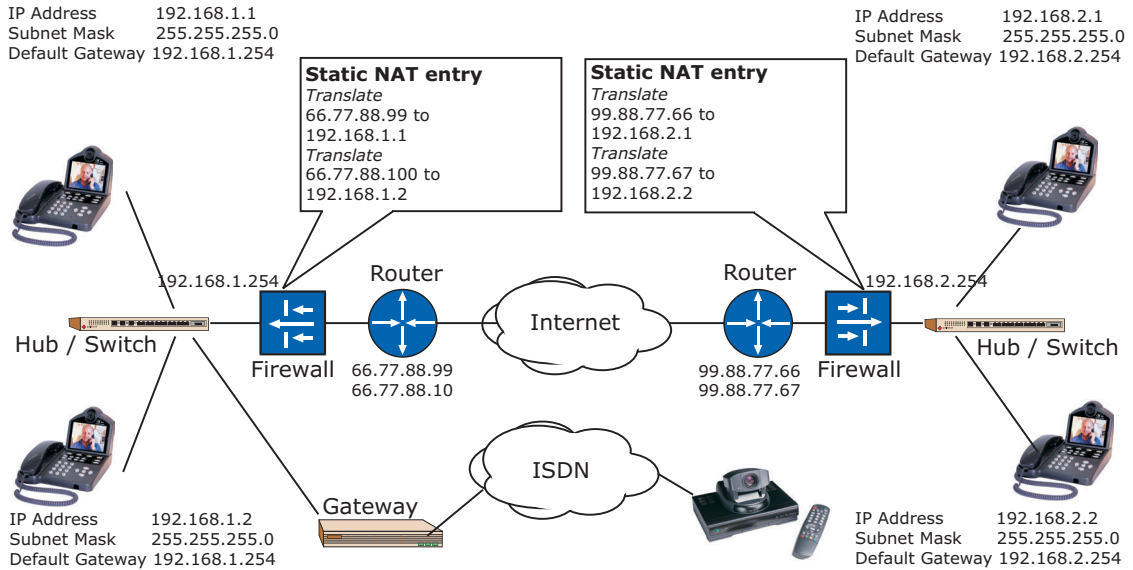

**Notes:** An external IP address and UDP port setting of 5000 is required for each videophone. You may need to unblock ports, 1718 - 1720, and 5000 - 5010 in the firewall. Ensure a viable technique is used for signaling between the gateway and the videophone.

# Index

## A

- A/V cables 45
- Asymmetrical mode 15
- Audio 13
- Audio options menu 26
- Auto answer 34
- Auto dialer 18
- Auto select for audio 26
- Aux ports 44

## B

- Bandwidth 4, 22, 63
- Baud rate 58

## C

- Call an extension number 29
- Call time 62
- Calls list 32
- Camera 9, 44, 51
- Camera port 46
- Camera presets 47
- Camera video setup menu 48
- Changing a menu field 12
- Changing a setting 12
- Communications 13
- Communications setup menu 17
- Components 6
- Connecting a TV set 45
- Connecting a VCR 51
- Connecting additional cameras 46
- Connecting other equipment 43
- Connecting the videophone
  - handset 7
  - network cable 8
  - power supply 8

## D

- Data options menu 57
- Data port 1 58
- Data port 2 59
- Data ports 57
- Data speed 22
- Default presets 47

- DHCP 20

- Diagnostic information 61

- Dialed calls list 26

## E

- Entering letters 12
- Entering numbers 12
- Ext Cam 47,58
- External connectors 44

## F

- Far 47
- Far end control 47,50
- Firewall 77
- Focusing the camera 9
- Frame rate 10
- Function buttons
  - image 39
  - picture in picture 38
  - privacy 39
  - snapshot 39
  - source 40
  - volume 38

## G

- Gatekeeper Address 15,18,22,23
- Gatekeeper Mode 24
- Gateway 77,79
- Getting best results
  - lighting 9
  - movement 10
  - sound 10

## H

- H.323 Extension 24
- H323 ID 24
- Handshaking 58, 59
- Highlighting a field 8
- Host 58

## I

- ID 55
- ID Display 53
- Image 13
- Image options menu 25
- Information 59

Information screen 59  
Intercom answer 18, 29  
Intercom dial 14  
Internet connectivity Appendix A  
IP address 30,75

**L**  
Lighting 9

**M**  
Making a call  
    manual dialing 28,30  
    speed dialing 31  
Manual dial screen 30  
Menu layout 12  
Missed calls list 27,32  
Movement 10

**N**  
Name 14, 24, 30  
Name field 30  
NAT address 24  
Near end control 38  
Net Mask 20, 75  
Network configuration Appendix A  
Network setup 20  
Network statistics screen 60

**P**  
Phone book 14  
    entering contacts 14  
    navigating 14  
    setting up 14  
    speed dialing 31  
Picture in picture 36  
PIN 51  
PIN mode 51  
PiP 36  
Preset 47  
Privacy 39  
PTZ cameras 46

**R**  
Received calls list 32  
Receiving a call 35  
Remote access 54

Remote camera access 40  
Remote control of cameras 49  
Requirements 6  
Resolution 41

**S**  
Screen size 41  
Security PIN 51  
Selecting menu options 12  
Self view 38  
Setting default preset 47  
Setting the user mode 53  
Setting up the videophone 11  
Setup H323 24  
Setup menu 12  
Setup menu options 14  
Slave mode 16  
Snapshot 39  
Snapshot button 37  
Sound 10  
Source button 40  
Speed dial menu 31  
Speed dialing 31  
Start button 31  
Supervisor mode 53  
Supervisor PIN 56  
    using in a call 56  
Switching between video sources 45

**T**  
Technical specification  
    audio and video inputs 68  
    audio and video outputs 68  
    audio processing 68  
    display 67  
    environmental 70  
    external PTZ camera 68  
    industry recommendations 67  
    internal camera 68  
    packing 70  
    security features 69  
    video resolution 67  
Troubleshooting tips 66  
TV 47

## **U**

UDP port 4,18,21,64,78

Unpacking the videophone 6

Updating slave units 16

User ID 53

User options 53

User options menu 51,53,55

## **V**

VCR 49

Video mode 10, 25

Video presets 47

    setting up 47

    viewing 49

Volume 38

Volume buttons 37