

ACU1600A

Welcome to the ServSwitch™ Family!

Thank you for purchasing a BLACK BOX® ServSwitch™ Brand KVM switch! We appreciate your business, and we think you'll appreciate the many ways that your new ServSwitch keyboard/video/mouse switch will save you money, time, and effort.

That's because our ServSwitch family is all about breaking away from the traditional, expensive model of computer management. You know, the one-size-fits-all-even-if-it-doesn't model that says, "One computer gets one user station, no more, no less." Why not a single user station (monitor, keyboard, and mouse) for multiple computers—even computers of different platforms? Why not a pair of user stations, each of which can control multiple computers? Why not multiple user stations for the same computer?

With our ServSwitch products, there's no reason why not. We carry a broad line of robust solutions for all these applications. Do you have just two PCs, and need an economical alternative to keeping two monitors, keyboards, and mice on your desk? Or do you need to share dozens of computers, including a mix of IBM® PC, RS/6000®, Apple® Macintosh®, Sun Microsystems®, and SGI® compatibles among multiple users with different access levels? Does your switch have to sit solidly on a worktable and use regular everyday cables? Or does it have to be mounted in an equipment rack and use convenient many-to-one cables? No matter how large or small your setup is, no matter how simple or how complex, we're confident we have a ServSwitch system that's just right for you.

The ServSwitch™ family from Black Box—the one-stop answer for all your KVM-switching needs!

*

This manual will tell you all about your new ServSwitch™ Wizard Multimedia KVM Extender unit, including how to install, operate, and troubleshoot it. For an introduction to the Extender, see Chapter 2. The Extender product code covered in this manual is:

ACU1600A

This manual also includes information about the Extender's Rackmount Kit, whose product code is:

RMK19WX

TRADEMARKS USED IN THIS MANUAL

BLACK BOX and the  logo are registered trademarks, and ServSwitch and ServSwitch Wizard are trademarks, of Black Box Corporation.

Apple and Macintosh are registered trademarks of Apple Computer, Inc.

Compaq is a registered trademark of Compaq Computer Corporation.

Gateway is a trademark of Gateway 2000 Corporation.

Hewlett-Packard is a registered trademark of Hewlett-Packard.

IBM, PC/AT, PS/2, RS/6000, and ThinkPad are registered trademarks, and PC/XT is a trademark, of International Business Machines Corporation.

Genius and Netmouse are registered trademarks of KYE Systems Corp.

Logitech and MouseMan are registered trademarks, and Pilot Mouse is a trademark, of Logitech, Inc.

Microsoft and Windows are registered trademarks, and IntelliMouse is a trademark, of Microsoft Corporation.

SGI is a registered trademark of Silicon Graphics, Inc.

Sun and Sun Microsystems are registered trademarks of Sun Microsystems, Inc. in the United States and other countries.

Velcro is a registered trademark of Velcro USA Inc.

Any other trademarks mentioned in this manual are acknowledged to be the property of the trademark owners.

FEDERAL COMMUNICATIONS COMMISSION**AND****INDUSTRY CANADA****RADIO FREQUENCY INTERFERENCE STATEMENTS**

This equipment generates, uses, and can radiate radio-frequency energy and if not installed and used properly, that is, in strict accordance with the manufacturer's instructions, may cause interference to radio communication. It has been tested and found to comply with the limits for a Class A computing device in accordance with the specifications in Subpart J of Part 15 of FCC rules, which are designed to provide reasonable protection against such interference when the equipment is operated in a commercial environment. Operation of this equipment in a residential area is likely to cause interference, in which case the user at his own expense will be required to take whatever measures may be necessary to correct the interference.

Changes or modifications not expressly approved by the party responsible for compliance could void the user's authority to operate the equipment.

This digital apparatus does not exceed the Class A limits for radio noise emission from digital apparatus set out in the Radio Interference Regulation of Industry Canada.

Le présent appareil numérique n'émet pas de bruits radioélectriques dépassant les limites applicables aux appareils numériques de la classe A prescrites dans le Règlement sur le brouillage radioélectrique publié par Industrie Canada.

CE COMPLIANCE STATEMENT

This equipment has been tested and found to comply with the limits for a class A computing device in accordance with the specifications in the European standard EN55022. These limits are designed to provide reasonable protection against harmful interference. This equipment generates, uses and can radiate radio-frequency energy, and if not installed and used in accordance with the instructions, might cause harmful interference to radio or television reception. However, there is no guarantee that harmful interference will not occur in a particular installation. If this equipment does cause interference to radio or television reception, which can be determined by turning the equipment on and off, you can correct the interference with one or more of the following measures:

- (a) Reorient or relocate the receiving antenna.
- (b) Increase the separation between the equipment and the receiver.
- (c) Connect the equipment to an outlet on a circuit different from that to which the receiver is connected.
- (d) Consult the supplier or an experienced radio/TV technician for help.

Shielded cables must be used with this equipment to maintain compliance with radio frequency emission regulations and ensure a suitably high level of immunity to electromagnetic disturbances.

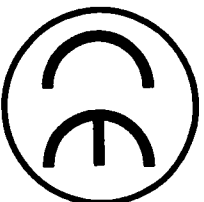
**NORMAS OFICIALES MEXICANAS (NOM)
ELECTRICAL SAFETY STATEMENT**
INSTRUCCIONES DE SEGURIDAD

1. Todas las instrucciones de seguridad y operación deberán ser leídas antes de que el aparato eléctrico sea operado.
2. Las instrucciones de seguridad y operación deberán ser guardadas para referencia futura.
3. Todas las advertencias en el aparato eléctrico y en sus instrucciones de operación deben ser respetadas.
4. Todas las instrucciones de operación y uso deben ser seguidas.
5. El aparato eléctrico no deberá ser usado cerca del agua—por ejemplo, cerca de la tina de baño, lavabo, sótano mojado o cerca de una alberca, etc.
6. El aparato eléctrico debe ser usado únicamente con carritos o pedestales que sean recomendados por el fabricante.
7. El aparato eléctrico debe ser montado a la pared o al techo sólo como sea recomendado por el fabricante.
8. Servicio—El usuario no debe intentar dar servicio al equipo eléctrico más allá a lo descrito en las instrucciones de operación. Todo otro servicio deberá ser referido a personal de servicio calificado.
9. El aparato eléctrico debe ser situado de tal manera que su posición no interfiera su uso. La colocación del aparato eléctrico sobre una cama, sofá, alfombra o superficie similar puede bloquear la ventilación, no se debe colocar en libreros o gabinetes que impidan el flujo de aire por los orificios de ventilación.
10. El equipo eléctrico deber ser situado fuera del alcance de fuentes de calor como radiadores, registros de calor, estufas u otros aparatos (incluyendo amplificadores) que producen calor.
11. El aparato eléctrico deberá ser conectado a una fuente de poder sólo del tipo descrito en el instructivo de operación, o como se indique en el aparato.

Contents

Chapter	Page
1. Specifications	9
2. Introduction	12
2.1 Features and Benefits of the Extender	13
2.2 The Complete Extender Package	15
2.3 The Extender Illustrated	16
2.4 Safety Concerns	17
3. Installation	18
3.1 What You Will Need	18
3.2 Placement	19
3.3 Connecting Your Devices	20
3.3.1 Connecting User Equipment (Not Including Serial Equipment)	20
3.3.2 Connecting CPU/KVM-Switch Ports (Not Including Non-Mouse Serial Ports)	20
3.3.3 Connecting Serial Equipment/Ports (Optional)	21
3.4 Interconnecting the Extender Units	24
3.5 Powering the System	24
4. Configuration	26
4.1 Configuring Your PCs	27
4.2 Configuring the Extender	28
4.2.1 Setting the DIP Switches	28
4.2.2 Using Configuration Mode	32
4.2.2.A Setting the Video Compensation	32
4.2.2.B Issuing Other Configuration-Mode Keyboard Commands	34
4.3 Configuring for a Serial Mouse	36
4.4 Setting a Password for the Extender	36
4.5 Resetting the Extender to Its Factory-Default Configuration	37

12. Precaución debe ser tomada de tal manera que la tierra física y la polarización del equipo no sea eliminada.

13. Los cables de la fuente de poder deben ser guiados de tal manera que no sean pisados ni pellizcados por objetos colocados sobre o contra ellos, poniendo particular atención a los contactos y receptáculos donde salen del aparato.

14. El equipo eléctrico debe ser limpiado únicamente de acuerdo a las recomendaciones del fabricante.

15. En caso de existir, una antena externa deberá ser localizada lejos de las líneas de energía.

16. El cable de corriente deberá ser desconectado del cuando el equipo no sea usado por un largo periodo de tiempo.

17. Cuidado debe ser tomado de tal manera que objetos líquidos no sean derramados sobre la cubierta u orificios de ventilación.

18. Servicio por personal calificado deberá ser provisto cuando:

A: El cable de poder o el contacto ha sido dañado; u

B: Objetos han caído o líquido ha sido derramado dentro del aparato; o

C: El aparato ha sido expuesto a la lluvia; o

D: El aparato parece no operar normalmente o muestra un cambio en su desempeño; o

E: El aparato ha sido tirado o su cubierta ha sido dañada.

Contents (continued)

Chapter	Page
5. Operation	38
5.1 Power-Up Status	38
5.2 The Extender's LEDs	39
5.3 How the Extender Uses the Keyboard LEDs	40
5.4 Switching Between CPUs at the Primary Control Station	42
5.5 Contending for Control of the Primary CPU	43
5.6 Things to Keep in Mind About the Keyboards and Mice	45
5.7 Keyboard Control: Hotkey Commands	46
5.8 Mouse Control	48
5.9 Hot-Plugging PS/2 Mice and Mouse Ports into the Extender and Re-Enabling Disconnected CPU PS/2 Mouse Ports	49
5.10 Audio Support (Stereo Speakers/Headphones and Microphone)	51
5.11 RS-232 Serial Support	52
6. Troubleshooting	54
6.1 Things to Try	54
6.2 Resetting the Extender (Hardware Reset)	57
6.3 Displaying the Extender's Firmware Revision	57
6.4 Calling Black Box	58
6.5 Shipping and Packaging	58
Appendix A: Guidelines for Twisted-Pair Cabling	59
Appendix B: Serial Pinouts	61
Appendix C: Rackmounting	63

1. Specifications

- Cable Required** — Between Units A and B: Four-pair (eight-wire) Category 5 or higher unshielded twisted-pair (UTP); shielded twisted-pair (STP) can also be used at shorter distances
- Compliance** — CE (EN55092 Class A); FCC Part 15 Subpart J Class A, IC Class/class A
- Standards** — VGA, SVGA, XGA, or XGA-2 video
- Interfaces** —
- Video: VGA;
 - Keyboard and mouse: IBM PS/2 compatible; with appropriate adapters, also supports IBM PC/AT keyboard and EIA/TIA RS-232 serial mouse on these PS/2 ports;
 - Serial: EIA/TIA RS-232, pinned according to TIA-574, DCE;
 - Audio: 3.5-mm stereo
- Resolution and Refresh Rate** —
- At distances to 65 m (210 ft.): Up to 1600 x 1280 noninterlaced at up to 85 Hz;
 - At distances to 100 m (325 ft.): Up to 1600 x 1280 noninterlaced at up to 65 Hz;
 - At distances to 200 m (655 ft.): Up to 1024 x 768 noninterlaced at up to 65 Hz;
- See Section 4.1 for more details about these guidelines
- Supported Serial Characteristics** —
- Transmission protocol: Asynchronous;
 - Handshaking/device protocol: Mouse (supersedes all other RS-232 settings), hardware, or none, user-selectable;
 - Data rate: 1200 or 9600 bps, user-selectable;
 - Data format: 7 or 8 data bits, even, odd, or no parity; and 1 or 2 stop bits; user-selectable

Maximum**Distance —**

Between Units: Up to 200 m (655 ft.) of unshielded twisted-pair cable or 100 m (325 ft.) of shielded twisted-pair cable;

From Unit A without optional power supply:

2 m (6 ft.) to any attached keyboard, monitor, or mouse;

3 m (10 ft.) to any attached CPU;

10 m (32 ft.) to any attached audio or serial device;

From Unit B or from Unit A with optional power supply:

10 m (32 ft.) to any attached keyboard, monitor, or mouse;

15 m (50 ft.) to any attached audio or serial device;

20 m (65 ft.) to any attached CPU

User Controls —

Keyboard commands;

Mouse-click functions;

(1) Side mounted 8-position DIP switch on each Unit; switches on Units A and B control different options and functions

Indicators —

(3) Top-mounted LEDs on each Unit:

On Unit A: Power (green), Primary Control (red), and

Local Control (red);

On Unit B: Power (green), Primary CPU (red), and

Local CPU (red);

Extender also indicates compensation, control-lockout, and password-lockout modes by flashing various patterns on the Num Lock, Caps Lock, and Scroll Lock LEDs of the attached keyboard(s)

Connectors —

All side-mounted on both Units A and B (user/peripheral connections optional on Unit A, CPU connections optional on Unit B):

(2) HD15 female: (1) to monitor, (1) to CPU's video port;

(4) 6-pin mini-DIN female: (1) to keyboard, (1) to mouse, (1) to CPU's keyboard port, and (1) to CPU's mouse port;

(4) 3.5-mm stereo jacks: (1) to audio-input device,

(1) to audio-output device, (1) to CPU's audio-in port, (1) to CPU's audio-out port;

(1) DB9 female for serial-device attachment;

(1) Barrel jack for power-supply attachment

Power —

Unit A *without* using included power supply:

5 VDC at 500 mA from attached CPU's keyboard interface;

Unit B or Unit A *using* included power supply:

Input: 100 to 240 VAC at 50 to 60 Hz from utility-power (mains) outlet, through detachable power cord and IEC 320 inlet, to external transformer;

Output: 5 VDC at up to 2.5 A from transformer to Extender (Unit A normally draws only 500 mA,

Unit B draws only 1.5 A);

Consumption: Typically 2.5 watts by Unit A, 7.5 watts by Unit B

Maximum**Altitude —**

10,000 ft. (3048 m)

Temperature**Tolerance —**

32 to 104°F (0 to 40°C)

Humidity**Tolerance —**

5 to 60% noncondensing

Enclosure —

Steel and aluminum

Size —

1.3"H x 6.5"W x 5.6"D (3.3 x 16.5 x 14.2 cm)

Weight —

Net: 1.1 lb. (0.5 kg) per Unit;

Shipping: At least 7.5 lb. (3.4 kg)

2. Introduction

The ServSwitch™ Wizard Multimedia KVM Extender is a high-performance keyboard, monitor, and mouse-extension device that supports a wide range of IBM® PC compatible hardware and software platforms. It also supports audio and serial extension, and it supports switching between remote and optional same-site connections.

The Extender consists of a "Unit A" to which you'll attach the I/O ports of a computer CPU plus a "Unit B" to which you'll attach a control station (keyboard, monitor, mouse, and, if you want, audio-input and audio-output devices). These two Units are linked together with cable rated to at least Category 5. You can even attach a second control station to Unit A and/or a second CPU to Unit B and switch between the primary and secondary equipment.

Important: Throughout this manual, we'll use a set of terms to refer to the components of an Extender system. Please familiarize yourself with these terms, which are listed below, as you refer to the system diagram in Figure 2-1 on the next page.

- **Unit A** is the unit attached to the primary CPU (the CPU that can be accessed from either of the two control stations).
- **Unit B** is the unit attached to the primary control station (the control station that can access either of the two CPUs).
- The **primary CPU** is the required CPU attached to Unit A. It can be accessed either from the local control station, also attached to Unit A, or across the Extender's CAT5 link from the primary control station attached to Unit B; these stations contend for access.
- The **local CPU** is the optional CPU attached to Unit B. It can be accessed only by the primary control station, also attached to Unit B.
- The **primary control station** is the required control station attached to Unit B. It can either access the local CPU, also attached to Unit B, or reach across the Extender's CAT5 link to access the primary CPU; this access is user-switchable.
- The **local control station** is the optional control station attached to Unit A. It can access only the primary CPU, also attached to Unit A.

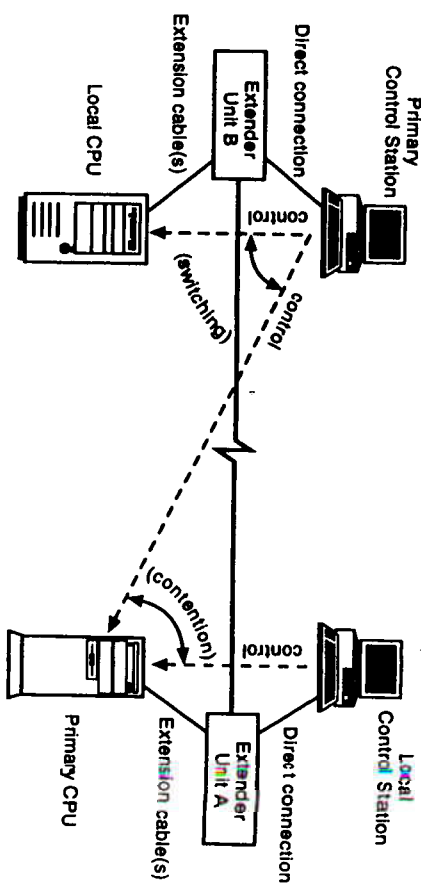

Figure 2-1. Attachment and control in an Extender system.

2.1 Features and Benefits of the Extender

Here are some of the useful features of the ServSwitch Wizard Multimedia KVM Extender and some of the ways those features benefit you:

- Control a local PC from a remote keyboard, monitor, and mouse up to 200 meters (655 ft.) away.
- Optionally, you can also control the local PC from a local keyboard, monitor, and mouse, or you can also control a remote PC from the remote keyboard, monitor, and mouse.
- Uses a single Category 5 (or higher) unshielded twisted-pair (UTTP) cable to carry all supported signals between the local and remote sites.
- Supports IBM PS/2®, PC/AT®, RS/6000®, or compatible computers.
- Password protection prevents unauthorized use.
- Finely user-adjustable video compensation for the best possible video quality at any supported cable length.
- Video compensation only needs to be done once, at installation time, because the compensation setting is saved in EEPROM memory even when the Extender is powered OFF.
- Supports high-bandwidth monitors at resolutions up to 1600 x 1280 pixels.

- Emulates the presence of a keyboard and mouse at both the local and remote sites. This means that the connected computer(s) can boot up automatically at any time.
- Supports keyboard modes 1, 2, and 3, as well as both "prompt" and "stream" mouse modes, for maximum compatibility.
- Mixed PC/AT and PS/2 keyboards and PS/2 and RS-232 mice supported as standard.
- Support for Microsoft® IntelliMouse® and other common "wheel" mice.
- CPU switching with keyboard hotkey sequence or 3-button or wheel mouse.
- Automatically restores keyboard and mouse states when you switch between local and remote PCs.
- Mouse-restoration functions to enable hot-plugging of certain systems.
- Supports stereo audio and microphone signals.
- Supports a single RS-232 serial link, which can be configured to suit most standard applications.
- Supports IBM ThinkPad® and its "Y" cables.
- Includes screen-blank, variable-hotkey, hardware-reset, and variable control-timeout options.
- LEDs on Extender indicate power status, the selected CPU, the controlling station, and data activity.
- Flashes keyboard LEDs to indicate compensation, control, and locked modes.
- Includes all necessary cables, so installation is easy.
- Robust metal case ensures good shielding and video quality.

2.2 The Complete Extender Package

You should have received these components with your ServSwitch Wizard Multimedia KVM Extender:

- The Extender's Unit A.
- The Extender's Unit B.
- Unit B's power supply.
- Unit A's optional power supply.
- Four Velcro® mounting strips (see Section 3.2 for information about using these).
- Two bonded three-to-three CPU-Extension Cables (our product code EHN408), one 5 ft. (1.5 m) long and one 10 ft. (3 m) long.
- Four 2.5-in (8.2-ft.) stereo audio cables, all with 3.5-mm stereo plugs. (These will work fine with mono equipment).
- One PS/2 to PC/AT keyboard-port adapter, 6-pin mini-DIN female to 5-pin DIN male, for connecting a CPU with a PC/AT style keyboard port.
- One PS/2 to serial mouse-port adapter, 6-pin mini-DIN female to DB9 female, for connecting a CPU with a serial mouse port.
- This manual.

If you didn't receive everything, or if anything arrived damaged, contact Black Box right away.

2.3 The Extender Illustrated

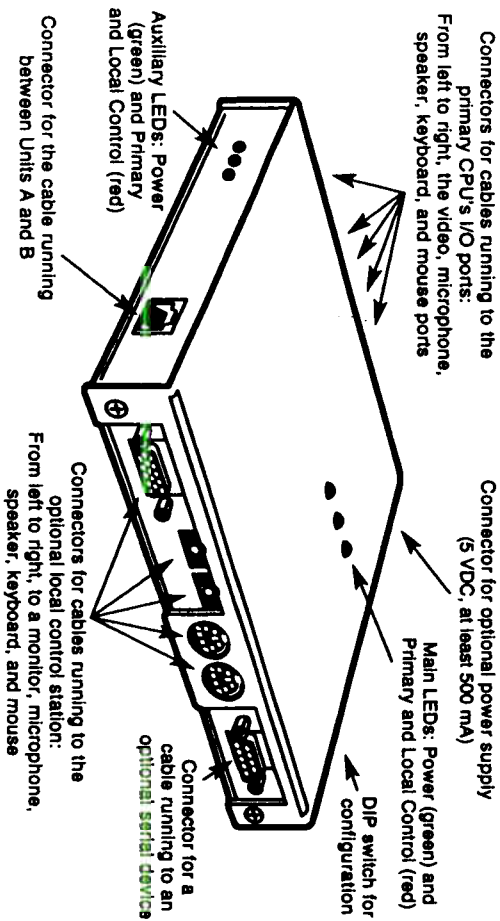

Figure 2-2. The Extender's Unit A.

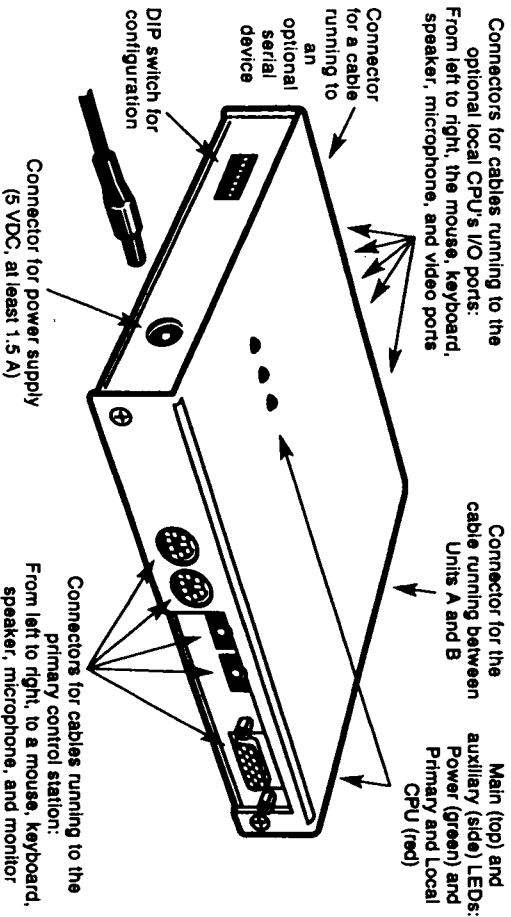

Figure 2-3. The Extender's Unit B.

2.4 Safety Concerns

As you prepare to install the ServSwitch Wizard Multimedia KVM Extender, please keep these things in mind, particularly if you purchase and use its optional power supply:

- The Extender is for use in dry, oil-free indoor environments only.
- **Warning:** The Extender's power supply contains no user-serviceable parts, but it does contain parts capable of delivering hazardous electric shocks—do not attempt to dismantle it!
- Plug the power supply into a socket outlet close to the Extender.
- Make sure that the rated current draw in amperes of all of the devices plugged into the same outlet or circuit as the Extender does not exceed the outlet's or circuit's rated current in amperes.
- Do not use the Extender's power supply if its case becomes damaged, cracked, or broken, or if you suspect that it is not operating properly.
- If the Extender's power supply stops working, replace it with a manufacturer-approved adapter of the same type only.

3. Installation

3.1 What You Will Need

These things must be in place before you can install your ServSwitch™ Wizard Multimedia KVM Extender:

- Four-pair (eight-wire) twisted-pair cabling rated to at least Category 5. This should be long enough to reach from your Extender's Unit A to its Unit B, up to a maximum of 300 meters (655 feet). Other specifications for this cabling are given in **Appendix A**.
You can make use of any Category 5 structured-cabling systems that might already be in place at your sites, but you should keep the number of cables and connectors involved to a minimum in order to maximize signal quality.
- The Extender comes with one PS/2 to PC/AT keyboard-port adapter and one PS/2 to serial mouse-port adapter so that you can connect an older CPU with these types of ports. If you want to connect two such CPUs, you'll need extra adapters (product code FA212 for the keyboard-port adapter, FA314 for the mouse-port adapter.)
- Monitor(s) with a standard VGA/SVGA (HD15) connector that will work when connected directly to each of your PCs. The Extender supports low- and high-resolution monitors.
- Standard PC/AT or PS/2 style keyboard(s). If you are using a PC/AT keyboard with a 5-pin DIN connector, you can connect it to the Extender using a standard PC/AT to PS/2 keyboard adapter such as our product code FA211.
- A PS/2 style two- or three-button Microsoft or Logitech® compatible mouse or a Microsoft IntelliMouse compatible mouse. If you want to use the mouse to switch CPUs on the Extender, you will need a three-button mouse or an IntelliMouse. (The Extender supports other "Internet mice" compatible with the IntelliMouse—fitted with a wheel or other scrolling control, and sometimes additional buttons—including the Logitech Pilot Mouse™+, Logitech MouseMan™+, Genius® NetMouse® and Genius NetMouse Pro.)
Keep in mind that the Extender will operate without a mouse connected if you don't want to use one.

- A suitable mouse driver for your PC(s). Supported types are:

- PS/2 or RS-232 two-button mouse driver by any manufacturer.
- Microsoft mouse drivers, including those for the IntelliMouse. (You might be able to use other mouse drivers with IntelliMouse compatible data formats, but these might or might not work—trial-and-error testing might be necessary.)

- Logitech mouse drivers, including those for two-button, three-button, and wheel mice.

The Extender will automatically configure its mouse output to match the type requested by any supported driver.

- Any audio devices (microphone, speakers, etc.) you want to use.
- Any standalone serial devices you want to use, along with any cables and adapters you'll need to hook them up. Refer to **Appendix B**.

3.2 Placement

The ServSwitch Wizard Multimedia KVM Extender has been designed to be either set on a desktop or surface-mounted close to the computers that it's serving. To mount the Extender on a wall or other surface, use the two Velcro strips that came with the unit. Peel the backing away from one side of each of the two strips and press the strips firmly onto the bottom of the unit (the wide flat area where there are no connectors and no LEDs). Then peel the backing away from the other side of the strips and press the bottom of the Extender firmly against the surface you want to mount the Extender on.

It is possible to rackmount the Extender using the Rackmount Kit designed specifically for it (our product code RMK19WX). Refer to **Appendix C** for the details of the rackmounting procedure.

3.3 Connecting Your Devices

First make sure the power supply is unplugged and disconnected from Unit B of the ServSwitch Wizard Multimedia KVM Extender. If you are powering the Extender's Unit A with an optional power supply, make sure that Unit A is unplugged and disconnected as well.

Also make sure that (if possible) all of the devices you want to attach to your Extender system are turned off and unplugged. (If you have to "hot-plug" any powered computers into the Extender, see Section 5.9.) You don't have to connect anything to ports on the Extender that you're not using.

3.3.1 CONNECTING USER EQUIPMENT (NOT INCLUDING SERIAL EQUIPMENT)

Plug a set of shared user equipment (keyboard, PS/2 mouse, monitor, microphone, and/or speakers) into the connectors on the Extender marked with the corresponding icons in the "CONTROL STATION" connector groups. (On Unit A, attach the optional local control-station equipment to the "LOCAL CONTROL STATION" connectors on the Unit's front panel. On Unit B, attach the necessary primary control-station equipment to the "PRIMARY CONTROL STATION" connectors on the Unit's front panel. Refer to Figure 3-1.)

3.3.2 CONNECTING CPU/KVM-SWITCH PORTS (NOT INCLUDING NON-MOUSE SERIAL PORTS)

Run cable from your computer CPU's keyboard, monitor, mouse, audio-in, and/or audio-out ports—or from one of your KVM switch's user ports—to the connectors on the Extender marked with the corresponding icons in the "COMPUTER" group. (On Unit A, attach the necessary primary CPU or ServSwitch family KVM switch to the "PRIMARY COMPUTER OR KVM SWITCH" connectors on the Unit's rear panel. On Unit B, attach the optional local CPU to the "LOCAL COMPUTER" connectors on the Unit's front panel. Refer to Figure 3-1.)

The Extender comes with a pair of specially bonded three-to-three CPU-Extension Cables that you can use to make the keyboard-, video-, and mouse-port attachments. One is 5 ft. (1.5 m) long, the other is 10 ft. (3 m) long; we recommend that you use the shorter one with the local CPU or switch, so that Unit A can get as much of the device's keyboard-port power as possible. These cables are designed as shown in Figure 3-2. The central coaxial video strand of each cable is molded to the keyboard and mouse strands on either side, and the ends of its video strand are one inch (2.5 cm) longer than the ends of the other strands, so that the weight of the composite cable can be borne by the video connector's screwlocks. To help you tell the otherwise identical keyboard and mouse strands apart, the keyboard strand is labeled "K" and colored orange, while the mouse

strand is labeled "M" and colored green.

NOTE

If you need to connect a CPU with a PC/AT type 5-pin DIN keyboard port, use the included PS/2 to PC/AT keyboard-port adapter. (If both of your CPUs have this type of keyboard port, you'll need another one of these; order our product code FA212.)

Likewise, if you need to connect a CPU with a serial mouse port but you don't want to use the Extender's serial ports for that purpose, use the included PS/2 to serial mouse-port adapter. (If both of your CPUs have serial mouse ports, you'll need another one of these; order our product code FA314.)

To make the audio attachments, we've also included four audio cables with the Extender, all 2.5 m (8.2 ft.) long and all with 3.5-mm stereo plugs. (These will work fine even with mono equipment.) You can use one pair to connect to the audio-in and audio-out ports of the CPU or switch attached to Unit A, and the other pair to connect to the audio-in and audio-out ports of the CPU attached to Unit B. If you use other audio cables, they shouldn't be longer than 15 m (50 ft.)

3.3.3 CONNECTING SERIAL EQUIPMENT/PORTS (OPTIONAL)

If you'll be using a serial device with an attached cable at either end of your Extender link, you might be able to plug it into the Extender's DB9 female "SERIAL" connector through an adapter or gender changer (call Black Box for technical support). On Unit A, this connector is next to the "LOCAL CONTROL STATION" connector group on the front panel; on Unit B, this connector is next to the "LOCAL COMPUTER" connector group on the rear panel.

If you'll be using a serial device without an attached cable, such as a CPU's serial port, run a serial cable from your device to the Extender Unit's "SERIAL" connector. This cable must have a DB9 male connector on the Unit end. To attach a PC or other DTE with a DB9 male connector, you can use DB9 extension cable such as our product code EDN12H-MF (specify length). If you need to attach a DTE with any other type of connector, or if you need to attach a DCE, call Black Box for technical support.

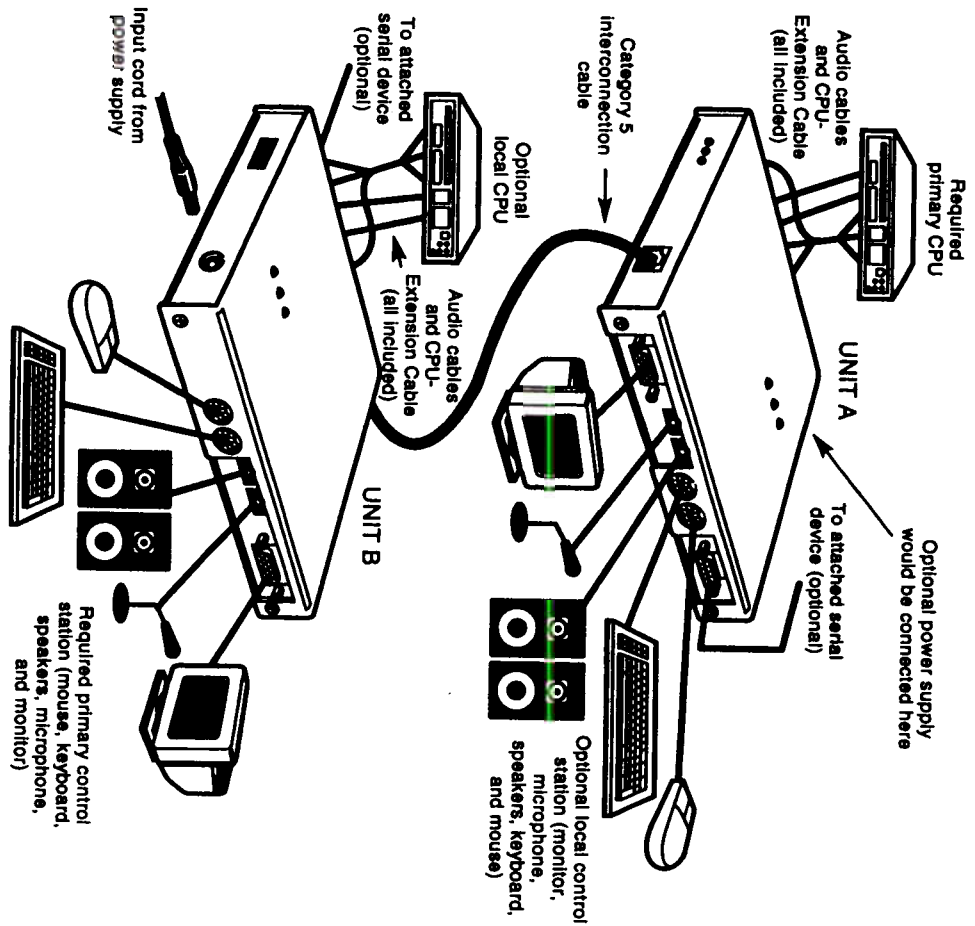

Figure 3-1. A fully installed Extender system, including all optional attachments.

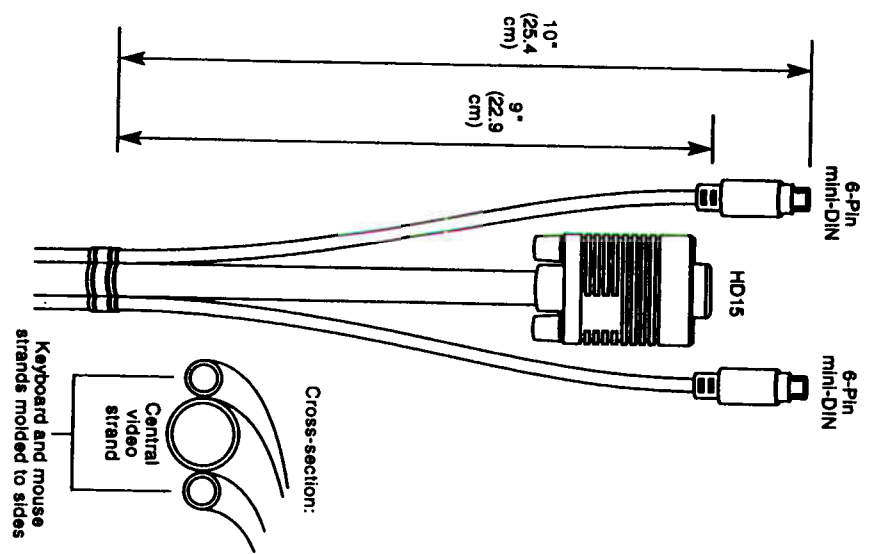

Figure 3-2. The CPU-Extension Cables.

3.4 Interconnecting the Extender Units

Run eight-wire (four-pair) twisted-pair cabling rated to at least Category 5 between the RJ-45 jacks on the sides of Units A and B of your ServSwitch Wizard Multimedia KVM Extender. This cable should be no longer than 200 meters (655 feet). Other specifications for this cabling are given in [Appendix A](#).

You can make use of any Category 5 structured-cabling systems that might already be in place at your sites, but you should keep the number of cables and connectors involved to a minimum in order to maximize signal quality.

3.5 Powering the System

Once you hook up all of your devices to the ServSwitch Wizard Multimedia KVM Extender and interconnect its Units A and B, plug in all of your AC-powered attached devices (CPU[s], KVM switch, monitor[s], serial device[s], etc.) and turn all of them ON except for the CPU(s) and/or KVM switch (which must always be the last things to be powered up in your system).

VERY IMPORTANT!

The picture on your monitor might look bad at this point. This is because you must fine-tune the Extender's video compensation before you operate the Extender for the first time. See [Section 4.2.2.A](#).

Now plug the output cord of one of the included power supplies into the barrel jack on the side of Unit B. Then plug the power supply's input cord into a working AC outlet. Your Unit B will begin operating.

The order in which you do the last few steps depends on how you want to power Unit A. If you're attaching a normal CPU to Unit A using the cable we've supplied, the CPU should provide the Unit with enough keyboard-port power to operate. But if you're attaching a CPU or KVM switch that supplies low voltage on its keyboard port, or if you're using CPU cable(s) whose length totals more than 3 m (10 ft.), or if you're using very-high-resolution video, you might have to use the optional power supply (also included) to make sure that Unit A gets enough power.

- *If you use the power supply:* Plug the output cord of that power supply into Unit A, and plug the power supply's input cord into a working AC outlet. Unit A will then begin operating. Turn ON the CPU or KVM switch attached to Unit A and any CPU attached to Unit B. Your entire system should begin operating. Compare the states of the LEDs on the Extender and your keyboard with those listed in [Sections 5.2](#) and [5.3](#); if they all appear normal, configure your system as described in [Chapter 4](#).

- *If you want to try to power Unit A without using the power supply:* Turn ON the CPU or KVM switch attached to Unit A. Then check either of Unit A's green Power LEDs (the main one is on the top panel and the auxiliary one is on the side). If these LEDs are *flashing*, Unit A is not getting enough power to operate properly. You'll have to power the CPU or switch back down and use the power supply instead, as described on the previous page. If, however, these LEDs are *steadily lit*, Unit A is getting enough power—at least for now. Go ahead and power up any CPU attached to your Unit B. Your entire system should begin operating. Compare the states of the LEDs on the Extender and your keyboard with those listed in [Sections 5.2](#) and [5.3](#); if they all appear normal, configure your system as described in [Chapter 4](#).

4. Configuration

To configure your ServSwitch™ Wizard Multimedia KVM Extender system, you'll need to configure first the attached PCs, as directed in Section 4.1, then the Extender itself, as directed in the rest of this chapter.

IMPORTANT NOTES

Before you operate the Extender for the first time, you must fine-tune its video-compensation amplifiers—the picture will look awful unless you do. See Section 4.2.2.A.

Throughout the rest of this manual, the [Enter] designation refers to the main "enter" or "carriage-return" key (often labeled "↵") on the main section of the keyboard. Do not use the "Enter" key on the numeric keypad or the extra "Enter" key found on the main section of some specialized keyboards.

4.1 Configuring Your PCs

Configure your PCs in the same way that you would if your keyboard, mouse, monitor, speaker, and/or microphone were all connected directly to them, but keep these things in mind:

- The Extender emulates Microsoft compatible serial, IntelliMouse, and PS/2 mice, so make sure that your PC software is configured for a Microsoft mouse of the correct type. Refer to the list of supported drivers in Section 3.1.
- The Extender supports VGA, SVGA, XGA, and XGA-2 type monitors, but does not support the automatic detection features available with some Plug-and-Play monitors and video cards. If you have this type of video card or monitor, you should select the video mode manually instead of relying on the automatic detection feature.

The **Resolution and Refresh Rate** specification in Chapter 1 lists the maximum resolutions and refresh rates that the Extender can clearly display at various distances. These figures should be taken as guidelines only, however. The Extender will attempt to display video signals no matter what their resolution or frequency, but will lose sharpness as distance, resolution, and/or refresh rate increases. The lower the resolution, the higher the refresh rate can be, and vice versa.

- You can maximize the quality of the sound signals transmitted through your Extender's speaker channels by turning up the audio-output level from your PC as high as it will go, then turning down the speaker volume at the control stations as necessary.
- You can maximize the quality of the sound signals transmitted through your Extender's microphone channels by turning down the audio-input level to the lowest level at which the voices of the microphone users can still be clearly heard.

4.2 Configuring the Extender

The ServSwitch Wizard Multimedia KVM Extender has a large number of configuration options. You'll set different options using one of two different methods:

- Various basic options are controlled with the eight-position DIP switches on Units A and B. See Section 4.2.1.
- Video compensation and other advanced options are controlled with keyboard commands after the Extender is placed in "configuration mode." See Section 4.2.2.

4.2.1 SETTING THE DIP SWITCHES

You can use the 8-position DIP switches on the side of Units A and B of the Extender to set some of the Extender's more fundamental configuration options. The Extender comes from the factory preset to default configuration settings (corresponding to all DIP-switch positions OFF) which are suitable for most applications. If you need to set the Extender differently, you can move the DIP-switch positions as required. (You can do this even if the Extender is operating, because the Extender scans its DIP switches continuously.)

Use positions 6, 7, and 8 of the DIP switch on the Extender's Unit B (shown in Figure 4-1 on the next page) to set the Extender's hotkey combination. (The hotkey combination is the combination of keyboard keys that triggers the Extender to look for a keyboard command—see Section 5.7.) The available options are [Ctrl] + [Alt] (the factory-default setting), [Ctrl] + [Shift], [Alt] + [Shift], right [Alt] only, left [Alt] + right [Alt], left [Ctrl] + left [Alt], right [Ctrl] + right [Alt], or hotkeys disabled. (While hotkeys are disabled, no hotkey commands can be sent to the Extender, including the command to access configuration mode. In this situation, you'll have to set position 5 of Unit A's DIP switch ON and cycle power to Unit B to get into configuration mode.)

Positions 1 through 5 of this DIP switch are reserved for future use and must remain set to OFF.

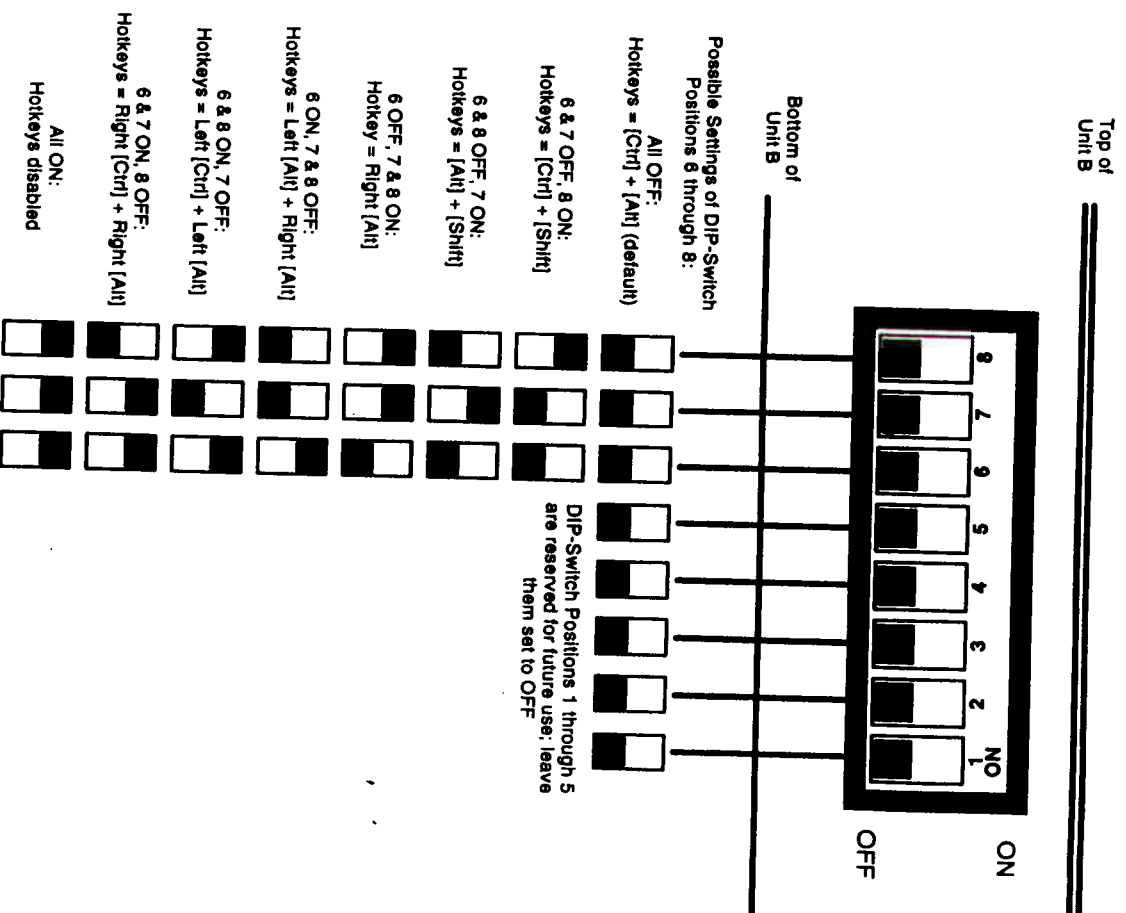

Figure 4-1. Unit B's DIP switch.

Use different numbered positions of the DIP switch on the Extender's Unit A, shown in Figure 4-2 on the next page, to set other options for your Extender system:

- Set position 1 to ON to reset the Extender (see Section 6.2). For normal operation, leave this switch set to OFF.
 - Set position 4 to ON to disable serial-mouse detection and force the Extender to configure itself for a PS/2 mouse. This setting is only necessary when you are using PS/2 "Y" cables to attach certain Compaq® laptop computer models to the Extender. These cables present unusual voltages on their PS/2 mouse leads, which causes the Extender to erroneously detect the presence of a serial mouse, after which the PS/2 mouse will not work. Setting this position ON will stop this error from occurring (you should power down the Extender and power it back up again to make sure this setting takes effect, however). For normal operation with other computer types, leave this switch set to OFF.
 - Set position 5 to ON to force the Extender into configuration mode at power-up (see Sections 4.2.2 and 5.1). This is the only way to get into configuration mode when hotkeys have been disabled with Unit B's DIP switch (see page 28). For normal operation, leave this switch set to OFF.
 - Use position 6 to determine whether the local CPU's video output is always broadcast to both monitors (OFF, the default setting) or is exclusively displayed on the monitor of the most recently active control station only, while the other monitor is blanked (ON). The "exclusive" setting is useful when one of the monitors is in a public area and you don't want activity at the other station to be displayed on it.
 - If you have two control stations installed in your system, use positions 7 and 8 to set the Extender's timeout period (the length of time that the user at one station must be idle before the Extender will give the user at the other station control over the primary CPU). The possible settings are 2, 10, 30, and 120 seconds. See Section 5.5.
- (Positions 2 and 3 of this DIP switch are reserved for future use and must remain set to OFF.)

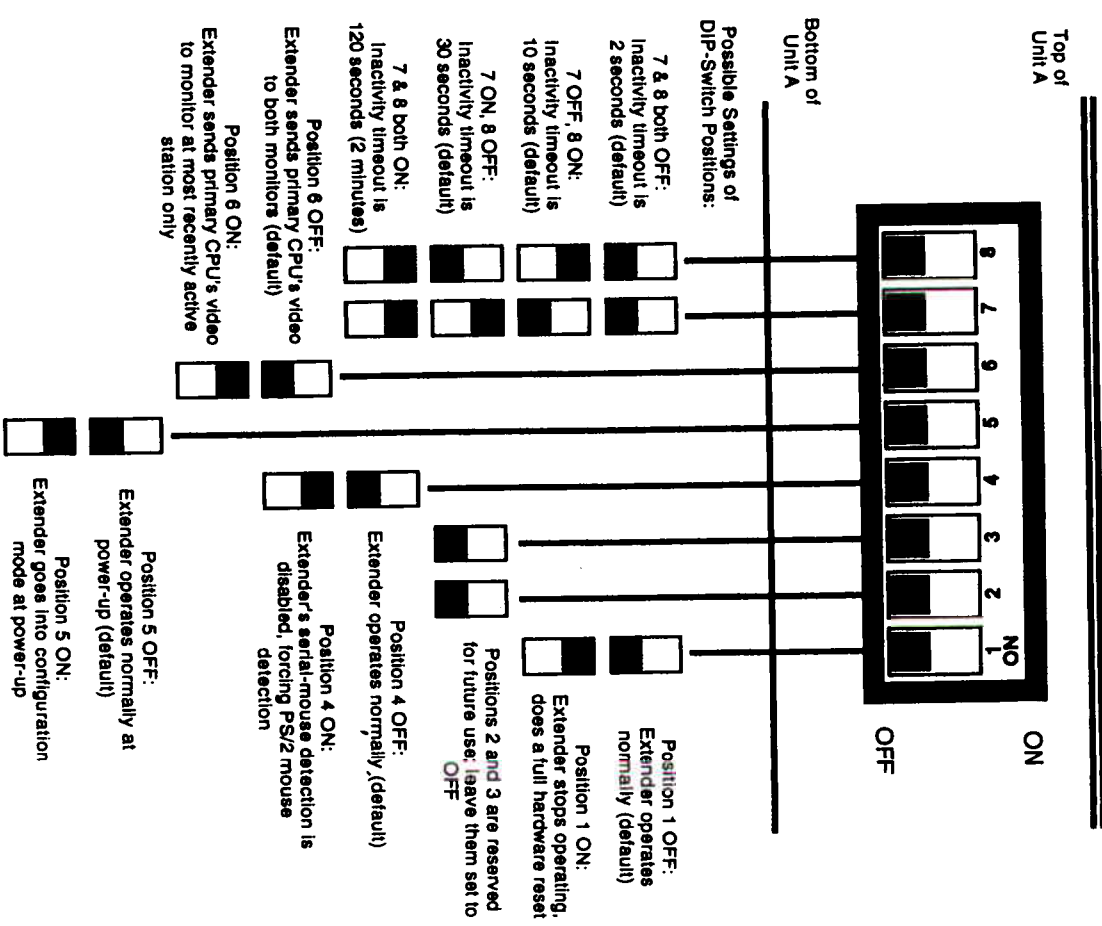

Figure 4-2. Unit A's DIP switch.

4.2.2 USING CONFIGURATION MODE

If hotkeys are currently enabled (see Section 4.2.1), you can put the Extender in configuration mode by pressing the currently selected hotkeys along with the [Enter] key at the *primary control station's keyboard only*. For example, if the currently selected hotkey combination is the default pairing of [Ctrl] and [Alt], press [Ctrl] + [Alt] + [Enter] to activate configuration mode. Once you do this, you will see the Num Lock, Caps Lock, and Scroll Lock LEDs on your keyboard begin to flash one after another in a cycling pattern, like this:

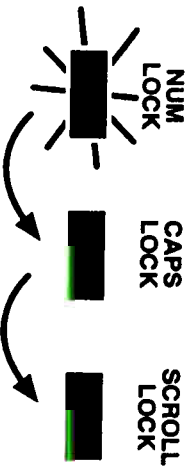

Figure 4-3. The configuration-mode LED pattern.

Alternatively, if you'll be reconfiguring your Extender system frequently, you can set Position 5 of Unit A's DIP switch to ON in order to force the Extender to go into configuration mode automatically every time it powers up.

Once the Extender is in configuration mode, you can change its video compensation (see Section 4.2.2.A) or set various other options (see Section 4.2.2.B).

4.2.2.A Setting the Video Compensation

The Extender contains video-compensation equalizers that maximize the picture quality for your system even though the video signal is being sent across twisted-pair cable. But when you first plug in the Extender, you might notice that the picture appears distorted or blurred or doesn't appear at all. To fix this, take these steps:

1. Go into configuration mode as described at the top of this page. Observe *how fast* the Num Lock, Caps Lock, and Scroll Lock LEDs on your primary control station's keyboard are flashing; this indicates the level of compensation currently being applied. If they're flashing slowly (to a minimum of one cycle per second for zero distance), the Extender is compensating at a low level suitable for shorter runs of twisted-pair cable. If they're flashing quickly (to a maximum at which the cycling can no longer be distinguished and it looks like all the LEDs are "half on" for 200 m [655 ft.]), the Extender is compensating at a high level suitable for longer runs of twisted-pair cable.

2. Press the [Home] key on the primary keyboard to set video compensation to "none." The picture on the primary monitor will probably become fuzzy.

3. Use any of these keys to "tune" the Extender's video compensation:
 - [Home] sets video compensation to zero.
 - [Pg Up] increases the video compensation coarsely (in large increments).
 - [↑] (up-arrow) increases the video compensation finely (in small increments).
 - [Pg Dn] decreases the video compensation coarsely (in large increments).
 - [↓] (down-arrow) decreases the video compensation finely (in small increments).

As you change the video-compensation setting, you'll see the sharpness of the picture change (the Extender automatically recalculates the required matching brightness). Adjust the video compensation until you get the best picture. The longer your twisted-pair cable, the more compensation you'll need, but if you add too much compensation you might wash out the picture altogether. (If this happens, just reduce your compensation, and the picture will reappear.)

This might be the best technique for quickly finding the best compensation setting: First, press [Pg Up] until you see white trailing edges on the right-hand side of black text or graphics, as shown in Figure 4-4 below. Then press and release [↓] until the trailing edges disappear. At that point, compensation should be about as close to ideal as you can make it.

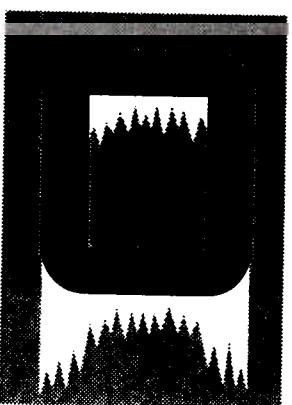

Figure 4-4. "Bleed" due to overcompensation.

4. When you find the best possible picture—and finish entering any other configuration commands (see Section 4.2.2.B)—press [Enter] to save the configuration setting and exit configuration mode. The compensation setting is saved in EEPROM, so it will persist even if the Extender is powered off. For this reason, unless you change your twisted-pair cabling, you shouldn't need to adjust this setting again.

4.2.2.B Issuing Other Configuration-Mode Keyboard Commands

While the Extender is in configuration mode, it is also possible to enter a number of other keyboard commands that you can use to configure advanced options on the Extender. (There are also commands for such functions as displaying the Extender's firmware revision, restoring a disconnected mouse port, and resetting all of the keyboard-controlled configuration options to their factory-default states.)

Most of these commands consist of pressing a letter key followed by a number key followed by [Enter]. For example, to set the Extender's serial data rate to 1200 bps, type in [B], then [1], then [Enter]. When you do this, the flashing Num Lock, Caps Lock, and Scroll Lock LEDs on your primary keyboard—which normally flash in sequence during configuration mode—will be affected this way:

1. After you press the first key of a command sequence, the Num Lock, Caps Lock, and Scroll Lock LEDs will all be steadily lit. Any invalid character will be ignored.
2. After you press the second key of the sequence, the Num Lock and Caps Lock LEDs will remain lit and the Scroll Lock LED will go dark. Any invalid character will be ignored.
3. After you press [Enter] to end the sequence, the command will be executed (or rejected as incomplete if the second character was never entered) and the LEDs will go back to flashing in sequence.

Here are the keyboard commands you can give the Extender in configuration mode. (Letter keys are shown in uppercase, but the commands are not case sensitive.) The settings are explained in greater detail in the indicated sections of this manual.

- Set handshaking or device protocol (see Sections 4.3 and 5.11):
 [H] [1] [Enter] = Serial-mouse-compatible RS-232 device protocol (default; overrides all other RS-232 settings)
 [H] [2] [Enter] = Hardware handshaking
 [H] [3] [Enter] = No handshaking (data rate is limited to 1200 bps in this setting)
- Set RS-232 data rate (see Sections 4.3 and 5.11):
 [B] [1] [Enter] = 1200 bps (default)
 [B] [2] [Enter] = 9600 bps

- Set RS-232 data format (see Sections 4.3 and 5.11):

[S] [1] [Enter] = 1 stop bit (default)
 [S] [2] [Enter] = 2 stop bits
 [S] [3] [Enter] = No parity (default)
 [S] [4] [Enter] = Even parity
 [S] [5] [Enter] = Odd parity
 [S] [7] [Enter] = 7 data bits (default)
 [S] [8] [Enter] = 8 data bits

- Enable/disable mouse switching (see Section 5.8):

[M] [1] [Enter] = Switching between CPUs with a 3-button mouse or IntelliMouse is not supported (default)
 [M] [2] [Enter] = You can switch between CPUs with a 3-button mouse or IntelliMouse

- Restore mouse (see Section 5.9):

[M] [6] [Enter] = Restore regular mouse
 [M] [7] [Enter] = Restore IntelliMouse

- Set/clear password (see Section 4.4):

[P] [Enter] (password) [Enter] = Sets the Extender's password
 [P] [Enter] [Enter] = Clears the Extender's password

- [F] [1] [Enter] = Display firmware version (see Section 6.3)

- [F] [9] [Enter] = Reset to factory defaults (see Section 4.5)

When you finish entering configuration commands and/or adjusting the Extender's video compensation (see Section 4.2.2.A), press [Enter] to quit configuration mode and return to normal operation. The Num Lock, Caps Lock, and Scroll Lock LEDs on your keyboard will stop flashing and will return to the states they were in before.

4.3 Configuring for a Serial Mouse

It is possible to connect a serial mouse and a CPU's serial mouse port to the Extender's serial ports. If you do this, you must issue the hotkey command [H] [I] [Enter] to force the Extender to use serial-mouse protocol unless the Extender is still set to its factory-default configuration. This setting also forces 1200 bps, 8 data bits, 1 stop bit, and no other handshaking (flow control)—it overrides all of the Extender's other RS-232 configuration settings (refer to Section 5.11 for more information about these).

We strongly recommend, however, that if you want to attach a CPU with a serial mouse port, you use the included PS/2 mouse cable and PS/2 to RS-232 mouse-port adapter to connect it to the Extender's PS/2 mouse port instead. This is because the Extender can emulate a PS/2 mouse but can't emulate a serial mouse, which becomes very important during the PC's boot process: A PC whose serial-mouse port is connected to the Extender's serial port might fail to boot properly if Unit B loses power or is accidentally disconnected during bootup, which will never happen if you connect the PC to the Extender's PS/2 mouse port.

Refer to **Appendix B** for information about RS-232 cabling and for the pinout of the Extender's serial ports.

4.4 Setting a Password for the Extender

There are many situations where access to corporate file servers or sensitive information needs to be controlled. In such circumstances, the ServSwitch Wizard Multimedia KVM Extender's Unit A and the attached CPU can be locked away in a secure room or cabinet and controlled from the primary control station attached to Unit B.

The Extender also has a password that you can set to prevent unauthorized use. After setting a password, you can "lock" (disable) Unit B at any time by typing the hotkey sequence together with the letter "L" at the primary keyboard: [Ctrl] + [Alt] + [L] if the hotkey sequence is set to its default value, for example. While Unit B is locked, it doesn't output video to the monitor or speakers or accept input from the keyboard, mouse, or microphone, although the serial link remains enabled. The Unit indicates that it's locked by alternately flashing the Num Lock/Scroll Lock LED pair and the Caps Lock LED on the attached primary keyboard. It can only be unlocked if a user types in the password followed by [Enter] at the primary keyboard. Locking Unit B has no effect on Unit A, so any control station attached to Unit A should be secured in the same area as Unit A and its attached CPU.

The password is not case-sensitive and can be any combination of keystrokes, including function keys but excluding [Ctrl], [Alt], [Shift], and [Enter]. (For example, the password [F4] [F] [R] [E] [D] [Home] would be valid.) The length of the password can be from 1 to 40 characters, although for better security we recommend that the password be at least four characters long.

To set the password, first get into configuration mode by typing in the current hotkey sequence followed by [Enter] at Unit B's keyboard: [Ctrl] + [Alt] + [Enter] if the hotkey sequence is set to its default value, for example. Then type [P], followed by [Enter], followed by the password characters, followed by another [Enter] to save the password to nonvolatile memory. (This type of memory does not depend on active power or even a battery backup, so it can persist indefinitely.) For instance, to set the password to "open sesame", you would type in [P] [Enter] [O] [P] [E] [N] [Space] [S] [E] [S] [A] [M] [E] [Enter].

Don't worry if you type the password incorrectly; you can always re-enter it, even if you've exited and re-entered configuration mode. (Of course, if you discover that you messed up entering the password or can't remember what the password is only after someone locks Unit B, you will have to take these steps to recover: First power down Unit B, then move position 5 on Unit A's DIP switch to ON, then power Unit B back on. This will cause Unit B to power up directly into configuration mode, and you can then change or clear the password. When you've finished doing this, move position 5 of Unit A's DIP switch back to its default OFF setting so that Unit B will go back to powering up normally.)

If you want to remove the password after setting one, get into configuration mode, type the letter "P", and press the [Enter] key as before, but then press [Enter] again without typing in any other characters. (If you try to lock the Switch before you've set a password, or after you've removed the password, the Switch will still blank the video, but it won't prevent someone from selecting another CPU.)

4.5 Resetting the Extender to Its Factory-Default Configuration

If you want to set all of the ServSwitch Wizard Multimedia KVM Extender's keyboard-controlled configuration options back to their factory defaults, first go into configuration mode, then issue the [F] [8] [Enter] command. ("F" is the letter "F" followed by the number "8", not the [F8] function key.) This will also clear any password you've set, but it will have no effect on the Extender's video compensation, CPU selection, or locked/unlocked state, nor will it change any settings controlled with the Extender's DIP switches.

5. Operation

This chapter explains the general operation of the ServSwitch™ Wizard Multimedia KVM Extender. We recommend that you read this chapter carefully before starting to use the Extender; also make very sure you have read the important notes at the start of Chapter 4!

5.1 Power-Up Status

Under normal circumstances, the ServSwitch Wizard Multimedia KVM Extender is ready for use as soon as Units A and B power up. Remember, though, that unless you have its power supply plugged in, Unit A will be trying to draw power from the keyboard port of the attached CPU. In this case, if you boot up the attached CPU and Unit A's green Power LEDs start flashing rather than lighting steadily, the Unit isn't getting enough power to operate, so you should plug in its power supply after all.

How Unit B behaves at bootup when both Units are properly powered will depend on how position 5 of Unit A's DIP switch is set (see Section 4.2.1) and on whether you've set a password for the Extender or not (see Section 4.4):

- If position 5 is set to ON, the Extender will go directly into configuration mode (see Section 4.2.2), so that you can reconfigure it as necessary before pressing [Enter] to resume normal operation. (This is most commonly done to clear an incorrectly entered or forgotten password—see Section 4.4.)
- If position 5 is set to OFF but you haven't set a password, Unit B will establish a connection to Unit A and will light both its Power and Primary CPU LEDs.
- If position 5 is set to OFF and you *have* set a password, Unit B will light its Power LEDs only and will not display any video. It will show that it's expecting you to enter the password by alternately flashing the Num Lock/Scroll Lock LED pair and the Caps Lock LED on the attached primary keyboard. When you type in the password at Unit B's keyboard and press [Enter], Unit B will "unlock," stop flashing the keyboard LEDs, and then do the normal "non-password" bootup procedures (establish a connection to Unit A and light both its Power and Primary CPU LEDs).

5.2 The Extender's LEDs

The ServSwitch Wizard Multimedia KVM Extender's Units A and B each have two sets of three LEDs on them. The main set of LEDs is on the top panel of each Unit, so they can be read easily when the Unit is installed on a desktop or surface-mounted with the included Velcro strips. The auxiliary set of LEDs, identical to the main set but unlabeled, are on the same side of each Unit as the CAT5 cable jack, so they can be read easily when the Unit is rackmounted.

Here's how to interpret the LEDs on the Extender. First, the LEDs on Unit A:

Name	Color	Status	Means
Power	Green	ON	Unit A is operating normally.
		FLASHING	Unit A isn't getting enough power.
		OFF	Unit A isn't getting any power.
Primary Control	Red	ON	Keyboard or mouse data have been received from Unit B and the primary control station is accessing the primary CPU.
		OFF	The primary control station is not accessing the primary CPU.
Local Control	Red	ON	Keyboard or mouse data have been received from the local control station, which is accessing the primary CPU.
		OFF	The local control station is not accessing the primary CPU.

Now, the LEDs on Unit B:

Name	Color	Status	Means
Power	Green	ON	Unit B is operating normally.
		OFF	Unit B isn't powered.
Primary	Red	ON	The primary CPU is selected, but no keyboard or mouse data is being sent to it or received from it.
		FLASHING	The primary CPU is selected, and keyboard or mouse data is being sent to it or received from it.
		OFF	The primary CPU is not selected.
Local CPU	Red	ON	The local CPU (the one attached to Unit B) is selected, but no keyboard or mouse data is being sent to it or received from it.
		FLASHING	The local CPU is selected, and keyboard or mouse data is being sent to it or received from it.
		OFF	The local CPU is not selected.

Several things can cause the Extender's Power LEDs to be dark or flashing. If you're running the Extender's Unit A from CPU-interface power, this can be caused by (in decreasing order of likelihood) loose/undone cable connections, CPU cables being run farther than 3 m (10 ft.), low power on the CPU's keyboard port, the CPU being powered OFF, cables being broken, Unit A's Power LEDs being defective, or Unit A's main board being defective.

On Unit B, and on Unit A if you're running it from AC power, this can be caused by (in decreasing order of likelihood) loose/undone power-supply connections, AC outlet being turned OFF/not working, power supply being broken, the Unit's Power LEDs being defective, or the Unit's main board being defective. If you can't determine the cause of this problem, call Black Box for technical support.

5.3 How the Extender Uses the Keyboard LEDs

The SerSwitch Wizard Multimedia KVM Extender also uses the LEDs on the attached keyboards to indicate various conditions. It will light the Num Lock, Caps Lock, and Scroll Lock LEDs in several different ways:

- **Configuration-mode indicator—rolling sequence.** As shown in Figure 5-1 below, Unit B flashes the Num Lock, Caps Lock, and Scroll Lock LEDs on the attached primary keyboard in sequence to show that it's in configuration mode (see Section 4.2.2). Num Lock will light first while Caps Lock and Scroll Lock are dark. Then Caps Lock only will be lit, then Scroll Lock only, and then Num Lock again. The cycle repeats itself continuously until you exit configuration mode, after which the LEDs will be placed back in the states they were in before you went into configuration mode.

The speed of the cycle indicates how much video compensation the Extender is applying (which is one of the things you can set in configuration mode): A slow flash rate indicates low compensation suitable for shorter cable distances, while a fast flash rate indicates high compensation suitable for longer distances. For examples of actual rates and distances, see step 1 in Section 4.2.2.A.

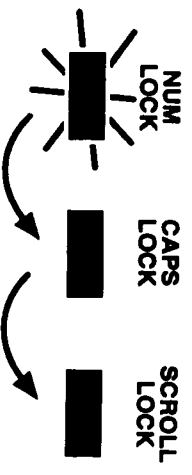

Figure 5-1. The configuration-mode LED pattern.

- **Control-lockout indication—unison flashing.** As shown in Figure 5-2 below, the Extender flashes all three LEDs on either keyboard at the same time (all three ON, then all three OFF, repeating indefinitely) to show that the other control station has exclusive control of the primary CPU. Once the inactivity timeout expires (see Section 4.2.1) so that the user at that station can take control of the CPU, these LEDs will stop flashing and return to their previous states.



Figure 5-2. The control-lockout LED pattern.

- **Password-lockout indication—lightbar flashing.** As shown in Figure 5-3 below, while the Extender is locked and waiting for the user to enter a password (see Sections 4.4 and 5.1), it alternately lights the Num Lock/Scroll Lock LED pair and the Caps Lock LED on the primary keyboard. This pattern of flashing alternate LEDs is similar to that of the lights in the lightbar of a police car. Once you type in the correct password and press [Enter], these LEDs will stop flashing and return to their previous states.

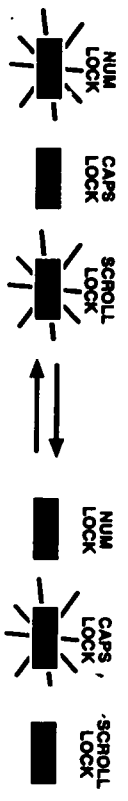

Figure 5-3. The password-lockout LED pattern.

5.4 Switching Between CPUs at the Primary Control Station

If you have the optional local CPU connected to Unit B as well as the primary CPU connected to Unit A, you can switch between the two CPUs *at the primary control station only*. You can do this with a hotkey command (see Section 5.7) or—if you enable mouse switching—with your three-button mouse or wheel mouse (see Section 5.8).

Depending on which CPU you have selected, the corresponding pair of Unit B's LEDs will be *steadily lit* if you aren't sending keyboard or mouse data or *flashing* if you are: either the "Primary CPU" LEDs for the CPU attached to Unit A, or the "Local CPU" LEDs for the CPU attached to Unit B. (These LEDs are red. The main LED of each pair is labeled and is on Unit B's top panel. The auxiliary LED of each pair is unlabeled and is on the Unit's right side: The auxiliary "Primary CPU" LED is the left-hand one, while the auxiliary "Local CPU" LED is the right-hand one.)

If you also have a local control station attached to Unit A, and its user is controlling the primary CPU, you can still switch from the local CPU to the primary CPU. But although you might be able to see the video from that CPU, you won't get keyboard and mouse control until the local station's user relinquishes control, as described in the next section.

You can always "switch to" the nonexistent "CPU zero" to blank the primary monitor and deselect your currently selected CPU (see Section 5.7). While CPU zero is selected, all of Unit B's CPU LEDs will be dark.

Note that no matter what CPU you switch to, any local→remote communication in progress through the Extender's serial ports (see Section 5.11) will continue uninterrupted.

5.5 Contending for

If you have the optional local CPU connected to Unit B as well as the primary CPU connected to Unit A, you can switch between the two CPUs *at the primary control station only*. You can do this with a hotkey command (see Section 5.7) or—if you enable mouse switching—with your three-button mouse or wheel mouse (see Section 5.8).

Depending on which CPU you have selected, the corresponding pair of Unit B's LEDs will be *steadily lit* if you aren't sending keyboard or mouse data or *flashing* if you are: either the "Primary CPU" LEDs for the CPU attached to Unit A, or the "Local CPU" LEDs for the CPU attached to Unit B. (These LEDs are red. The main LED of each pair is labeled and is on Unit B's top panel. The auxiliary LED of each pair is unlabeled and is on the Unit's right side: The auxiliary "Primary CPU" LED is the left-hand one, while the auxiliary "Local CPU" LED is the right-hand one.)

If you also have a local control station attached to Unit A, and its user is controlling the primary CPU, you can still switch from the local CPU to the primary CPU. But although you might be able to see the video from that CPU, you won't get keyboard and mouse control until the local station's user relinquishes control, as described in the next section.

You can always "switch to" the nonexistent "CPU zero" to blank the primary monitor and deselect your currently selected CPU (see Section 5.7). While CPU zero is selected, all of Unit B's CPU LEDs will be dark.

Note that no matter what CPU you switch to, any local→remote communication in progress through the Extender's serial ports (see Section 5.11) will continue uninterrupted.

station's users can reclaim control if they are the first to select the primary CPU. But if a user at the local station is the first to select the primary CPU after the timeout expires, users at the primary station must then wait until the local user relinquishes control.

Users at the local station can try to take keyboard and mouse control of the primary CPU (and gain audio access to it) in either of two ways that will yield two different results:

- They can try to assert *normal* control by simply typing something at their keyboard or moving their mouse. This type of control is governed by the inactivity timeout in the same way that the primary station's control always is.
- They can try to assert *exclusive* control by selecting the primary CPU with the [Hotkeys] + [1] command (see Section 5.7). This type of control lasts indefinitely (the inactivity timeout is disabled), until the local station's users deliberately relinquish control by issuing the [Hotkeys] + [0] command to select "CPU zero."

If the primary CPU is being controlled by a user at the primary station (which should be obvious from the state of Unit A's LEDs), these attempts will fail, although the users at the primary station will still be able to see the primary CPU's video. If the primary CPU is available (the user at the primary station isn't controlling it), these attempts will succeed. The Extender will display the primary CPU's video on the primary monitor, and will give the users at the primary station keyboard and mouse control (as well as audio access).

A note about audio: While the primary CPU is available (idle, not selected by users at either station), its audio input and audio output will continue, to and from the station that most recently controlled it (see Section 5.10).

5.6 Things To Keep in Mind About the Keyboards and Mice

PC bootup sequence: When your PC CPUs are powered on, they communicate with any attached keyboards and mice and load the setup parameters required by their particular operating systems. It is necessary for the Extender to be attached and powered on during this sequence so that it can give the CPUs the required responses and keep track of all the modes and settings requested by each of the connected CPUs.

Mouse characteristics: Do not unplug a PS/2 mouse connection from a CPU while the CPU is on. Because of the way PS/2 mice communicate, the CPU will lose mouse function and you will have to reboot the CPU to regain normal operation. Unplugging a shared PS/2 mouse from the Extender will have no immediate effect, but the PC will lose mouse function as soon as you plug the mouse back in. (RS-232 mice can usually be freely unplugged and replugged, provided that an RS-232 mouse was connected when the operating system initially booted.) The Extender has a PS/2 mouse-recovery system which allows you to disconnect and reconnect the mouse without powering down the system, but we recommend using this only when absolutely necessary. See Section 5.9 for details.

Keyboard- and mouse-mode handling during CPU switching: The Extender keeps a log of the keyboard and mouse modes and resolution settings requested by each of the connected CPUs, including the keyboard Num Lock, Caps Lock, and Scroll Lock states. These settings are automatically restored to the primary keyboard and mouse when you switch to the other CPU, as well as when the Extender is returned from configuration, password-lockout, or control-lockout mode to normal operation, ensuring maximum software compatibility.

5.7 Keyboard Control: Hotkey Commands

You can control several functions on the ServSwitch Wizard Multimedia KVM Extender—including CPU selection, screen blanking, locking, and entering configuration mode—from the keyboard, using commands triggered with the Extender's currently selected hotkey combination. All of the hotkey-control commands are invoked by holding down the one or two hotkeys and then pressing a command key. By default, the two hotkeys are [Ctrl] and [Alt], but you can change to any of six other combinations by setting positions 6 through 8 of the DIP switch on the Extender's Unit B (see Section 4.2.1).

Normally, when you send a hotkey command, you have to release the hotkeys and the command key before you can send another one. The one exception to this rule is [Hotkeys] + [Tab], the "switch to the other CPU" command; you can "tab back and forth" between the CPUs by holding down the hotkeys and repeatedly pressing [Tab].

The hotkey commands are summarized below. Note that to generate the numeric digits in the commands that contain them, you need to press the number keys on the top row of the main section of the keyboard, *not* the number keys on the keypad; the Extender will not recognize keypad numbers.

- Use [Hotkeys] + [1] to select the primary CPU (the one attached to Unit A). If you issue this command at the primary station, you simply get normal access (governed by the inactivity timeout) if the primary CPU is available, or video or no access if it isn't. If you issue this command from the local station, you get *exclusive* access (the inactivity timer is turned off so that access can continue indefinitely) if the primary CPU is available, or at least video access if it isn't. See Section 5.5.
- Use [Hotkeys] + [2] at the primary station's keyboard only to select the local CPU (the one attached to Unit B).
- Use [Hotkeys] + [Tab] at the primary station's keyboard only to switch to the other CPU (the primary CPU if the local CPU is selected, or the local CPU if the primary CPU is selected).
- Use [Hotkeys] + [0] to select nonexistent "CPU zero." This causes the attached Extender Unit to (a) stop lighting its CPU LEDs, (b) disable keyboard and mouse input to any CPU (although Extender commands will still work), and (c) shut off the video output to the attached monitor. (Be aware that this will cause some monitors to go into standby mode or shut themselves off.) If you were controlling the primary CPU before you did this, the Extender starts counting down toward the inactivity timeout (even if you are at the local

station); if it expires before you reselect the primary CPU (which will reset the timer), the primary CPU will become available for either station to select. (In fact, if you are at the local station and have *exclusive* control of the primary CPU—see Section 5.5—this is the only way you can relinquish control.) You can re-enable video by selecting one of the "real" CPUs with the keyboard hotkeys or with the mouse (if mouse switching is enabled and the mouse is a 3-button or IntelliMouse type—see Section 5.8). If the CPU you select is available, or if you reselect the primary CPU and the inactivity timeout hasn't expired yet, you will gain keyboard and mouse control as well.

- Use [Hotkeys] + [L] at the primary station's keyboard only to lock Unit B. If no password has been set for the Extender (see Section 4.4), this command is equivalent to the [Hotkeys] + [0] command described on the previous page. If a password has been set, this command also causes Unit B to (a) stop accepting keyboard and mouse input except for password attempts until someone enters the password and (b) alternately light the Num Lock/Scroll Lock LED pair and the Caps Lock LED on the attached keyboard. Note that if anyone has tried to type something at Unit B's keyboard while the Extender is locked, you will have to press [Enter] to clear those characters so that they won't invalidate the password when you proceed to type it in.

- Use [Hotkeys] + [Enter] at the primary station's keyboard only to cause the Extender to go into configuration mode. See Section 4.2.2.

Examples of common hotkey commands (assuming the hotkeys are [Ctrl] and [Alt]):

- To select the primary CPU:
Press and hold [Ctrl] and [Alt], press and release [1], release [Ctrl] and [Alt].
- To "tab back and forth" between CPUs at the primary control station:
Press and hold [Ctrl] and [Alt], press and release [Tab] (repeat as many times as necessary), release [Ctrl] and [Alt].

5.8 Mouse Control

If you have attached two CPUs to your ServSwitch Wizard Multimedia KVM Extender, another convenient way to select between them at the primary control station is by using a three-button mouse. Simply hold down the central mouse button or "wheel" button, then click on the left-hand mouse button to switch to the other CPU (the one you don't currently have selected).

If you want to do this, you'll have to go into configuration mode (see [Section 4.2.2](#)) and issue the [M] [2] [Enter] command to enable mouse switching. (The Extender comes from the factory with mouse switching disabled.) To turn mouse switching back off after you've enabled it, issue the [M] [1] [Enter] command.

Be aware that if you enable mouse switching and use a regular three-button mouse to do it, you won't be able to use the mouse's center button for any application functions or other non-switching purposes. In fact, the Extender will tell the CPU that it has a 2-button mouse attached to it in this situation. (The wheel button on IntelliMouse and similar mice is not disabled this way.)

5.9 Hot-Plugging PS/2 Mice and Mouse Ports into the Extender and Re-Enabling Disconnected CPU PS/2 Mouse Ports

It is advisable to switch off the computer systems that are going to be connected to the ServSwitch Wizard Multimedia KVM Extender before you install them. However, even if this is not possible, most systems can be "hot-plugged" (connected to the Extender while they are powered and operating); the PS/2 mouse-port malfunctions this usually causes can often be overcome by using the Extender's mouse-restoration functions. (The keyboard connection will normally restore itself automatically.)

Let's take this from the top: On many PCs, mouse movement will be lost if the PS/2 mouse is unplugged and plugged back in while the PC is running. Mouse movement can then be restored only by rebooting the PC. This is because the mouse drivers only set up and enable the mouse when the PC is initially booted.

If you have powered down your Extender, or if you are attempting to hot-plug a system into it, you might be able to restore lost mouse movement using the Extender's mouse-restoration functions. These should be used with caution, because unpredictable results might occur if you select the wrong mouse type. If in doubt, restore the mouse by rebooting the PC normally.

Standard PS/2 mouse data is formatted differently than IntelliMouse data, so two reset functions are provided on the Extender. The type of data format expected by the PC depends on the driver and the type of mouse that was connected when the driver was booted. You can use the following table as a guide; note that the mouse-reset functions predict the likely mouse *resolution* settings but might not restore the *speed* or *sensitivity* of the mouse to exactly what they were when the PC originally booted:

Type of mouse/ system connected at bootup:	Driver type:	Probable expected data format:	Suggested restoration command:
PS/2	PS/2 only	PS/2	PS/2—type [M] [6]
PS/2	IntelliMouse	PS/2	PS/2—type [M] [6]
IntelliMouse	PS/2 only	PS/2	PS/2—type [M] [6]
IntelliMouse	IntelliMouse	IntelliMouse	IntelliMouse—type [M] [7]

To restore lost mouse movement on a CPU connected to the Extender:

1. At Unit B's keyboard, select the CPU that has lost its mouse movement.
2. Enter configuration mode (see Section 4.2.2) by pressing the hotkeys followed by [Enter].
3. To restore a PS/2 mouse connection, issue the [M] [6] [Enter] command. Or, to restore an IntelliMouse connection, issue the [M] [7] [Enter] command.
4. Press [Enter] again to exit configuration mode.
5. Move the mouse a short distance to make sure that the connection has been restored properly.

5.10 Audio Support (Stereo Speakers/Headphones and Microphone)

NOTE

Throughout this section, the word "speakers" is used to refer to both speakers and headphones.

You can attach stereo speakers and/or a microphone to either or both Unit A and Unit B of your ServSwitch Wizard Multimedia KVM Extender—see Section 3.3.1 for how to do this. The Extender is designed to connect any attached speakers and mike to the audio-out and audio-in ports, respectively, of the attached CPUs, although you can plug in any properly amplified audio source or destination instead.

The audio output from the primary CPU is always sent both to Unit A's speakers and to Unit B. But Unit B will only send the primary CPU's audio output to its attached speakers while the primary CPU is selected at the primary control station. When the primary station has the local CPU (the one attached to Unit B) selected instead, the local CPU's audio output goes to Unit B's speakers.

Similarly, although the local CPU on Unit B (when it's selected) only takes audio input from the microphone attached to Unit B, both audio inputs are always sent to Unit A. Which of these inputs Unit A passes along to the primary CPU depends on which keyboard and mouse most recently controlled that CPU: If it was the local keyboard and mouse, Unit A sends the local microphone's input. If it was the primary keyboard and mouse, Unit A sends the primary microphone's input.

The Extender transfers the audio signals between its Units by multiplexing them onto the video signals. This process can introduce some audio noise. To reduce this noise on the microphone signals, reduce the audio-input volume on the primary CPU to the lowest practical setting. To reduce this noise on the speaker signals, follow these guidelines:

- Set the audio-output volume on the primary CPU to maximum and turn down the volume at the speakers as necessary.

- Do *not* boost the bass of the audio-output signal if you can possibly avoid it.

The Extender is designed to carry audio signals with a maximum peak-to-peak range of 5 volts, which includes the audio output from most computers. If your primary CPU is outputting audio signals with a peak-to-peak value above 5 volts, be aware that they will interfere with the video signals during peak audio output. This can cause intermittent picture loss on the primary control station's monitor when the primary station has the primary CPU selected. To solve this problem, turn down the volume of the primary CPU's audio output until the picture on the primary monitor stabilizes.

5.11 RS-232 Serial Support

The ServSwitch Wizard Multimedia KVM Extender is designed to carry bidirectional communication between *one* RS-232 serial device or port attached to its Unit A and *one* such device or port attached to its Unit B. Unlike the way it handles other I/O, the Extender doesn't perform serial switching or contention: Even when the primary control station's keyboard and mouse are not in control of the primary CPU—and for that matter, even when the primary station is locked or selects "CPU zero"—local→remote serial communication will continue uninterrupted. So if your application calls for serial switching or contention, it will have to be handled by some other device.

The default data rate for the Extender's serial link is 1200 bps, which is suitable for serial mice. Its default protocol/handshaking setting is also for a serial mouse. That having been said, we strongly recommend using a PS/2 mouse rather than a serial mouse; see [Section 4.3](#).

9600 bps, the other possible data rate, will be better for most kinds of communication, including PC-to-PC and PC-to-printer. Keep in mind that any serial devices you attach to the Extender must be asynchronous, because the Extender doesn't support the RS-232 synchronous clock signals.

The second possible handshaking setting is "hardware." In this setting, the Extender "passes through" hardware flow control this way: When either Unit detects a high input level on its DTR lead (Data Terminal Ready, Pin 4), it signals the other Unit to raise its DSR and CTS leads (Data Set Ready and Clear to Send, Pins 6 and 8—which are electrically connected inside the Extender). This means that if you have two CPU serial ports or other DTEs communicating through the Extender, they can hardware-flow-control each other even if they're both attached to the Extender with standard, straight-through-pinned cables.

The third available handshaking setting is "none." In this setting, the Extender ignores the states of the control signals. This is ideal for continuous uncontrolled transmissions or for applications that use X-ON/X-OFF or other types of software flow control. However, the data rate is limited to 1200 bps in this setting.

You can also set the Extender's data format. The default format is 7 data bits, no parity, and one stop bit, but alternative settings include 8 data bits, even or odd parity, and two stop bits.

To set any of these serial options, refer to [Section 4.2.2](#) as you take these steps:

1. Go into configuration mode by pressing the hotkeys followed by [Enter] at the primary control station.
2. Issue the necessary command(s).
3. Press [Enter] again to exit configuration mode.

6. Troubleshooting

If you have difficulty with your ServSwitch™ Wizard Multimedia KVM Extender, see if the problem is listed in Section 6.1 and, if so, try the suggested remedies. You can also, at any time, reset the Extender itself as described in Section 6.2. If nothing helps, get the Extender's firmware-revision level as described in Section 6.3 if possible, then call Black Box Technical Support as directed in Section 6.4. If you need to ship your Extender, see Section 6.5.

6.1 Things To Try

Problem:

Poor video quality with smearing, fuzziness, or rippling.

Possible Solution:

Make sure that the video compensation has been set for your system, as described in Section 4.2.2.A. Make sure your Category 5 cable is pinned and paired properly; see Appendix A. Also, if you are using cables other than those that came with the Extender to make your video connections, make sure these are shielded or screened coaxial video cables.

Problem:

Video is lost during periods of very high audio output.

Possible Solution:

Turn down the CPU's maximum audio-output level.

Problem:

Your mouse does not move the cursor/pointer.

Possible Solutions:

1. Are you trying to use it with a Compaq laptop computer connected to the Extender with a "Y" cable? If so, you need to set position 4 of Unit A's DIP switch ON and power the Extender down and back up again to get the Extender to detect the mouse properly. See Section 4.2.1.
2. If you're using the mouse at the primary station, do this test: Watch Unit B's red Control LEDs while you move the mouse. If you move the mouse and these LEDs don't flash, then the Extender is not receiving data from the mouse—proceed with the next few steps.
3. Check the mouse's connection to the Unit and (if you're using the primary mouse to control the primary CPU) the CAT5 cabling between the Units; if the cable connections are OK, try removing and restoring power to the Extender.

4. If you are attempting to connect the mouse to a PS/2 mouse port on a CPU that has not been powered down, you will need to use the mouse-restoration function (see Section 5.9).

5. Make sure that you have an appropriate mouse driver loaded and that your computer's software is configured to accept a supported mouse of the type that you have connected (PS/2 or RS-232). See the relevant paragraphs on pages 18 and 19.

6. Make sure that (a) the mouse and computer were both connected to the Extender before any part of the system was powered up, and (b) the Extender was powered ON before the attached computer. If you're not sure whether this was the case, then (if it's possible to do so) power everything down, make sure all cable connections are correct and secure, power up the Extender's Unit B and (if you're powering it with its optional power supply) its Unit A, then power up all attached computers.

Problem:

Your keyboard does not function or functions only intermittently. The Num Lock LED does not always light when the Num Lock key is pressed.

Possible Solution:

Some older keyboards were designed for use with specific computers and are not truly PC/AT or PS/2 compatible. These are not common, but if you're having problems like this and you're using an old keyboard, try a newer keyboard.

Problem:

Just using your primary mouse in a normal way causes the Extender to unexpectedly select the other CPU.

Possible Solutions:

Some cheaper mice are not fully compatible with the Extender and can lose data, which—if mouse switching is enabled (see Section 5.8)—sometimes causes the Extender to interpret a data stream as a CPU-change request. Try using a Microsoft, Logitech, IBM, Compaq, or Hewlett-Packard® mouse instead. Make sure that you are using a Microsoft compatible mouse driver on your PC. Some drivers by other manufacturers can cause the mouse to use proprietary mouse-data formats that the Extender doesn't support. If you have unplugged and reconnected a mouse to the Extender—especially if the mouse is an IntelliMouse—use the mouse-restoration function (see Section 5.9).

Problem:

Compaq MX11800 model integrated keyboard and mouse only: The mouse consistently fails to boot when the Extender is connected to a PC running Windows NT 4.0 through its PS/2 style mouse port.

Possible Solutions:

There are three possible solutions to this problem:

1. Use a different type of mouse.
2. Connect the Extender to your NT 4.0 PCs through an adapter and one of the PC's serial ports rather than through its PS/2 port.
3. Select "CPU zero," or the other CPU if you have a second PC connected that isn't running NT 4.0, while NT is booting. You should be able to use the system normally once the logon screen appears.

6.2 Resetting the Extender (Hardware Reset)

The ServSwitch Wizard Multimedia KVM Extender has a hardware-reset function that does not require you to remove power to the Extender. To trigger a hardware reset, set position 1 of the DIP switch on the Extender's Unit A (see Section 4.2.1) to ON. This DIP-switch position is directly connected to the Extender's microprocessor; when you set it ON, the microprocessor essentially shuts down. To finish resetting the Extender, move position 1 back to OFF; power is restored to the microprocessor, which then performs a complete hardware reset.

6.3 Displaying the Extender's Firmware Revision

For technical-support purposes, it might be necessary to find out the firmware-release version of your ServSwitch Wizard Multimedia KVM Extender. To do this, select a CPU that is showing a DOS prompt or is running a text editor, word processor, etc.—it doesn't matter what software is running, as long as it displays characters typed in at the keyboard on the screen. Then refer to Section 4.2.2 as you take these steps:

1. Go into configuration mode by pressing the hotkeys followed by [Enter] at the primary control station's keyboard.
2. Get the Extender to report its firmware revision by issuing the [F] [1] [Enter] command. (" [F] [1]" is the letter "F" followed by the number "1", not the [F1] function key.)
3. Press [Enter] again to exit configuration mode.

The version number will be reported on the CPU screen as the letter "V" followed by three numbers, the first of which is the major revision level and the other two of which are the minor revision level. For example, if the Extender reports "V118", the firmware version is 1.18.

6.4 Calling Black Box

If you determine that your ServSwitch Wizard Multimedia KVM Extender is malfunctioning, *do not attempt to alter or repair the unit.* It contains no user-serviceable parts. Contact Black Box Technical Support at 724-746-5500.

Before you do, make a record of the history of the problem. We will be able to provide more efficient and accurate assistance if you have a complete description, including:

- the nature and duration of the problem;
- when the problem occurs;
- the components involved in the problem—that is, which Unit(s), what type of cable, what types of computers, what type of keyboard, brand of mouse, make and model of monitor, etc.;
- any particular application that, when used, appears to create the problem or make it worse; and
- the results of any testing you've already done.

6.5 Shipping and Packaging

If you need to transport or ship your ServSwitch Wizard Multimedia KVM Extender:

- Package it carefully. We recommend that you use the original container.
- Before you ship the unit back to Black Box for repair or return, contact us to get a Return Authorization (RA) number.

Appendix A: Guidelines for Twisted-Pair Cabling

To interconnect Units A and B of your ServSwitch™ Wizard Multimedia KVM Extender, you can use either shielded twisted pair (STP) or unshielded twisted pair (UTP) rated to Category 5 or higher. It should be pinned straight-through and paired according to the TIA-568A or (preferred) -568B specification, as shown in Figure A-1 on page 60.

CAUTION!

Do not use cables paired according to the USOC specification—Pin 1 with 2, 3 with 4, 5 with 6, and 7 with 8. These will work badly and will yield a particularly horrible picture.

We recommend a solid-core CAT5 cable such as our product codes EYN737MS (preterminated) or EYN737A (unterminated bulk); specify the length you'd like when you order. Terminate any unterminated cable with high-quality shielded RJ-45 plugs such as those in our FM732 (unshielded) and FM733 (shielded) 25-packs.

CAUTION!

Keep in mind that if you use shielded twisted-pair cable, the maximum distance at which the Extender will operate will be at least cut in half, to no farther than 100 m (325 ft.).

All twisted-pair cables are constructed in such a way that each of the twisted pairs has a slightly different twist ratio. This is done to reduce the electrical crosstalk between signals carried on adjacent pairs. Because of this, the wire distance that an electrical signal has to travel is different for the different pairs. This does not normally cause a noticeable problem—in fact, the twist differences have no effect at all on digital signals such as network data. But if you're sending higher video resolutions (which are analog signals) across long cables, you might start to see color separation caused by the red, blue, and green signals arriving at Unit B at slightly different times.

If this happens, you might be able to improve your video by reterminating your cable so that the video signals are on the pairs whose twist ratios are the closest to each other. Most network-quality cables have one pair that's much more tightly twisted than the other three; this pair should be avoided. Unfortunately, different manufacturers—and even different cable types by the same manufacturer—use different pairs for the “tight pair,” so call your cable supplier. If they can't tell you which pair to avoid, cut a short section off the end of the cable, open it up, and look at the pairs; the tight pair is usually quite obvious.

Appendix B: Serial Pinouts

The ServSwitch™ Wizard Multimedia KVM Extender's serial ports are RS-232 DCE interfaces pinned out this way on DB9 female connectors:

Pin 1: No connection	Pin 6: Data Set Ready (DSR), connected internally to Pin 8
Pin 2: Receive Data (RD)	Pin 7: No connection
Pin 3: Transmit Data (TD)	Pin 8: Clear to Send (CTS), connected internally to Pin 6
Pin 4: Data Terminal Ready (DTR)	Pin 9: No connection
Pin 5: Signal Ground (SGND)	

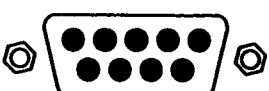

Note that, because these ports are DCE, the Extender actually *transmits* on Pin 2 (Receive Data) and *receives* on Pin 3 (Transmit Data). You should also be aware that when the Extender is set for serial mouse protocol or for hardware handshaking (see Section 5.11), it monitors Pin 4 (Data Terminal Ready) for flow-control input at each Unit and correspondingly raises or lowers Pins 6 and 8 (Data Set Ready and Clear to Send) for flow-control output at the other Unit.

The tables below and on the next page show how some of the cables and adapters you could plug into these ports should be pinned.

Cable from CPU's serial port to Extender for serial-mouse applications

DB9 female at CPU end	DB9 male at Extender end
2 (RD)	2 (RD)
3 (TD)	3 (TD)
5 (SGND)	5 (SGND)
7 (RTS)	4 (DTR)

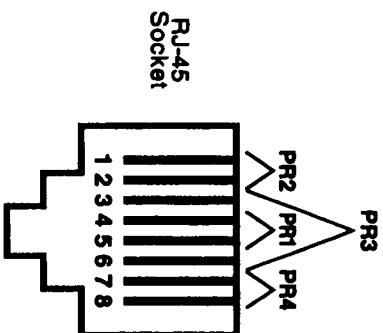

Cable Pinning: Straight-through (Pin 1 to Pin 1, 2 to 2, etc.)

Cable Pairing:

- Pair 1: Pins 4 and 5 (differential green video and vertical sync)
- Pair 2: Pins 1 and 2 (differential blue video, right channel of speaker audio, and half of microphone audio)
- Pair 3: Pins 3 and 6 (differential red video, horizontal sync, left channel of speaker audio, and half of microphone audio)
- Pair 4: Pins 7 and 8 (keyboard, mouse, and serial data)

Figure A-1. Twisted-pair cable specifications.

Adapter from serial mouse to Extender

DB9 male at mouse end	DB9 male at Extender end
2 (RD)	3 (TD)
3 (TD)	2 (RD)
4 (DTR)	6 (DSR)
5 (SGND)	5 (SGND)
6 (DSR)*	4 (DTR)*
7 (RTS)	8 (CTS)
8 (CTS)*	7 (No connection)*

*These leads/signals are not actually used, but they are included in this recommended pinout so that the adapter will work no matter which way it's plugged in.

Cable from CPU's serial port to Extender for serial-printer applications

DB9 female at CPU end	DB9 male at Extender end
2 (RD)	2 (RD)
3 (TD)	3 (TD)
4 (DTR)	4 (DTR)
5 (SGND)	5 (SGND)
6 (DSR)	6 (DSR)
8 (CTS)	8 (CTS)

Cable from serial printer to Extender

DB25 male at printer end	DB9 male at Extender end
2 (TD)	3 (TD)
3 (RD)	2 (RD)
5 (CTS)	8 (CTS)
6 (DSR)	6 (DSR)
7 (SGND)	5 (SGND)
20 (DTR)	4 (DTR)

Appendix C: Rackmounting

We offer a Rackmount Kit (our product code RMK19WX) for mounting a ServSwitch™ Wizard Multimedia KVM Extender's Unit A or Unit B in 1U of vertical space in a 19" rack. It consists of a front-paneled rack shelf and a pair of countersunk screws. To use this Kit to mount an Extender Unit, take these steps, referring to Figure C-1 below:

1. Place the Extender Unit on the Kit shelf so that the RJ-45 jack and auxiliary LEDs on its side are facing forward and are aligned with the cutouts in the shelf's front panel. In this position, the two screwholes on the bottom of the Unit should be lined up with the matching holes on the bottom of the shelf.
2. Screw the two screws included with the Kit through the holes in the shelf, into the bottom of the Unit.
3. Once you've attached the Unit to the shelf, match the holes at the ends of the shelf's front panel to an appropriate set of matching holes on your equipment rack. Screw the Unit assembly to the rack using your own screws, bolts, cage nuts, etc. (not included).

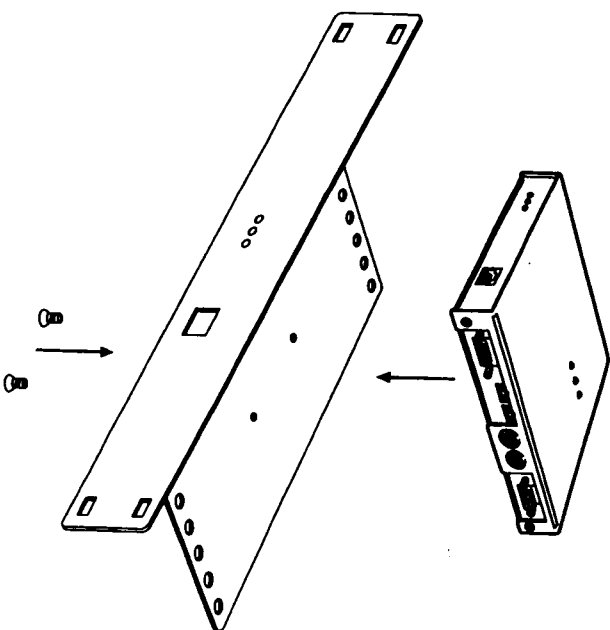

Figure C-1. Rackmounting an Extender Unit (Unit A shown).

DISCLAIMERS

While every precaution has been taken in the preparation of this manual, the manufacturer assumes no responsibility for errors or omissions. Neither does the manufacturer assume any liability for damages resulting from the use of the information contained herein. The manufacturer reserves the right to change the specifications, functions, or circuitry of the product without notice.

The manufacturer cannot accept liability for damage due to misuse of the product or due to other circumstances outside the manufacturer's control. And the manufacturer will not be responsible for any loss, damage, or injury arising directly or indirectly from the use of this product.