

ServSwitch™ BRAND
**CAT5 KVM Extender
Local Hubs**



ACU1006RA
ACU1006DRA
ACU1012RA
ACU1006SRA
ACU1006DSRA
ACU1006VRA
ACU1006DVRA

Welcome to the ServSwitch™ Family!

Thank you for purchasing a BLACK BOX® ServSwitch™ Brand CAT5 KVM Micro Extender model! We appreciate your business, and we think you'll appreciate the many ways that your enhanced keyboard/video/mouse system will save you money, time, and effort.

That's because our ServSwitch family is all about breaking away from the traditional, expensive model of computer management. You know, the one-size-fits-all-even-if-it-doesn't model that says, "One computer gets one user station, no more, no less." Why not a single user station (monitor, keyboard, and mouse) for multiple computers—even computers of different platforms? Why not a pair of user stations, each of which can control multiple computers? Why not multiple user stations for the same computer?

With our ServSwitch products, there's no reason why not. We carry a broad line of robust solutions for all these applications. Do you have just two PCs, and need an economical alternative to keeping two monitors, keyboards, and mice on your desk? Or do you need to share dozens of computers, including a mix of IBM® PC, RS/6000®, Apple® Macintosh®, Sun Microsystems®, and SGI™ compatibles among multiple users with different access levels? Does your switch have to sit solidly on a worktable and use regular everyday cables? Or does it have to be mounted in an equipment rack and use convenient many-to-one cables? No matter how large or small your setup is, no matter how simple or how complex, we're confident we have a ServSwitch system that's just right for you.

The ServSwitch™ family from Black Box—the one-stop answer for all your KVM-switching needs!

This manual will tell you all about your new ServSwitch™ Brand CAT5 KVM Extender Local Hub, including how to install, operate, and troubleshoot it. For an introduction to the Extender, see **Chapter 2**. The Extender product codes covered in this manual are:

ACU1006RA

ACU1012RA

ACU1006DSRA

ACU1006DVRA

ACU1006DRA

ACU1006SRA

ACU1006VRA

Copyrights and Trademarks

©2002/9. All rights reserved. This information may not be reproduced in any manner without the prior written consent of the manufacturer.

Information in this document is subject to change without notice and the manufacturer shall not be liable for any direct, indirect, special, incidental or consequential damages in connection with the use of this material.

All trademark and trade names mentioned in this document are acknowledged to be the property of their respective owners.

Disclaimer

While every precaution has been taken in the preparation of this manual, the manufacturer assumes no responsibility for errors or omissions. Neither does the manufacturer assume any liability for damages resulting from the use of the information contained herein. The manufacturer reserves the right to change the specifications, functions, or circuitry of the product without notice.

The manufacturer cannot accept liability for damage due to misuse of the product or due to any other circumstances outside the manufacturer's control (whether environmental or installation related). The manufacturer shall not be responsible for any loss, damage, or injury arising directly, indirectly, or consequently from the use of this product.

Cautions and Notes

The following symbols are used in this guide:



CAUTION. This indicates an important operating instruction that should be followed to avoid any potential damage to hardware or property, loss of data, or personal injury.



NOTE. *This indicates important information to help you make the best use of this product.*

**FEDERAL COMMUNICATIONS COMMISSION
AND CANADIAN DEPARTMENT OF COMMUNICATIONS****RADIO-FREQUENCY INTERFERENCE STATEMENTS**

This equipment generates, uses, and can radiate radio-frequency energy, and if not installed and used properly, that is, in strict accordance with the manufacturer's instructions, may cause interference to radio communication. It has been tested and found to comply with the limits for a Class A computing device in accordance with the specifications in Subpart B of Part 15 of FCC rules, which are designed to provide reasonable protection against such interference when the equipment is operated in a commercial environment. Operation of this equipment in a residential area is likely to cause interference, in which case the user at his own expense will be required to take whatever measures may be necessary to correct the interference.

Changes or modifications not expressly approved by the party responsible for compliance could void the user's authority to operate the equipment.

Shielded cables must be used with this equipment to maintain compliance with radio frequency energy emission regulations and ensure a suitably high level of immunity to electromagnetic disturbances.

This digital apparatus does not exceed the Class A limits for radio noise emission from digital apparatus set out in the Radio Interference Regulation of the Canadian Department of Communications.

Le présent appareil numérique n'émet pas de bruits radioélectriques dépassant les limites applicables aux appareils numériques de la classe A prescrites dans le Règlement sur le brouillage radioélectrique publié par le Ministère des Communications du Canada.

DECLARATION OF CONFORMITY

EUROPEAN UNION COMPLIANCE STATEMENT

WARNING!

This is a class A product. In a domestic environment, this product may cause radio interference, in which case the user might be required to take adequate remedial measures.

This product complies with the following harmonized standards for Information Technology Equipment: EN55022:2006 (Class A), EN55024:1998 + A1:2001 + A2:2003.

To maintain compliance the use of correctly installed shielded (STP/FTP) interconnection cable is advised. Only use CPU cables and power supplies provided (or recommended) for use with this product.

When used in environments that have high levels of electromagnetic interference or excessive power ground noise, you may experience disturbances to video and/or data transmission. If this is the case, please refer to the Troubleshooting section of the User Guide for further information, or contact Technical Support. In electrically noisy environments, the use of shielded (STP/FTP) rather than unshielded (UTP) interconnection cable is recommended.



NORMAS OFICIALES MEXICANAS (NOM)**ELECTRICAL SAFETY STATEMENT****INSTRUCCIONES DE SEGURIDAD**

1. Todas las instrucciones de seguridad y operación deberán ser leídas antes de que el aparato eléctrico sea operado.
2. Las instrucciones de seguridad y operación deberán ser guardadas para referencia futura.
3. Todas las advertencias en el aparato eléctrico y en sus instrucciones de operación deben ser respetadas.
4. Todas las instrucciones de operación y uso deben ser seguidas.
5. El aparato eléctrico no deberá ser usado cerca del agua—por ejemplo, cerca de la tina de baño, lavabo, sótano mojado o cerca de una alberca, etc..
6. El aparato eléctrico debe ser usado únicamente con carritos o pedestals que sean recomendados por el fabricante.
7. El aparato eléctrico debe ser montado a la pared o al techo sólo como sea recomendado por el fabricante.
8. Servicio—El usuario no debe intentar dar servicio al equipo eléctrico más allá a lo descrito en las instrucciones de operación. Todo otro servicio deberá ser referido a personal de servicio calificado.
9. El aparato eléctrico debe ser situado de tal manera que su posición no interfiera su uso. La colocación del aparato eléctrico sobre una cama, sofá, alfombra o superficie similar puede bloquea la ventilación, no se debe colocar en libreros o gabinetes que impidan el flujo de aire por los orificios de ventilación.
10. El equipo eléctrico deber ser situado fuera del alcance de fuentes de calor como radiadores, registros de calor, estufas u otros aparatos (incluyendo amplificadores) que producen calor.
11. El aparato eléctrico deberá ser conectado a una fuente de poder sólo del tipo descrito en el instructivo de operación, o como se indique en el aparato.
12. Precaución debe ser tomada de tal manera que la tierra física y la polarización del equipo no sea eliminada.
13. Los cables de la fuente de poder deben ser guiados de tal manera que no sean pisados ni pellizcados por objetos colocados sobre o contra ellos, poniendo particular atención a los contactos y receptáculos donde salen del aparato.

14. El equipo eléctrico debe ser limpiado únicamente de acuerdo a las recomendaciones del fabricante.
15. En caso de existir, una antena externa deberá ser localizada lejos de las líneas de energía.
16. El cable de corriente deberá ser desconectado del cuando el equipo no sea usado por un largo periodo de tiempo.
17. Cuidado debe ser tomado de tal manera que objetos líquidos no sean derramados sobre la cubierta u orificios de ventilación.
18. Servicio por personal calificado deberá ser provisto cuando:
 - A: El cable de poder o el contacto ha sido dañado; u
 - B: Objetos han caído o líquido ha sido derramado dentro del aparato; o
 - C: El aparato ha sido expuesto a la lluvia; o
 - D: El aparato parece no operar normalmente o muestra un cambio en su desempeño; o
 - E: El aparato ha sido tirado o su cubierta ha sido dañada.

Safety Precautions and Installation Guidelines

To ensure reliable and safe long-term operation please note the following installation guidelines:

- Do not use to link between buildings.
- Only use in dry, indoor environments.
- If the building has 3-phase AC power, try to ensure that equipment connected to the Local and Remote Units is on the same phase.
- Try not to route the CATx link cable alongside power cables.
- The use of shielded CATx cable is recommended to maintain compliance.
- Ensure that the system connected to the Local Unit is connected to power ground.
- This product is not suitable for use in isolated medical environments.



To safeguard against personal injury and avoid possible damage to equipment or property, please observe the following:

- Only use power supplies originally supplied with the product or manufacturer-approved replacements. Do not attempt to dismantle or repair any power supply. Do not use a power supply if it appears to be defective or has a damaged case.
- Connect all power supplies to grounded outlets. In each case, ensure that the ground connection is maintained from the outlet socket through to the power supply's AC power input.
- Do not attempt to modify or repair this product, or make a connection from the CATx link interface (RJ45) to any other products, especially telecommunications or network equipment.

Contents

1. Overview	10
1.1 Introduction	10
1.2 Glossary	10
1.3 Features	12
1.4 Product Range	13
1.5 Compatibility	14
1.6 How to Use This Guide	16
2. Installation	17
2.1 Package Contents	17
2.2 Interconnection Cable Requirements	18
2.3 Local Hub Installation	19
3. Operation	24
3.1 Overview	24
3.2 Operation of Dual Access Standard & Serial Local Hubs	25
3.3 Operation of Dual Access Audio/Serial Local Hubs	27
4. Troubleshooting	29
4.1 Video	29
4.2 Audio	30
4.3 Serial	30
4.4 Keyboard & Mouse	31
4.5 General Questions	32
Appendix A: Example Applications	33
Appendix B: Audio/Serial Ports	38
Appendix C: Calling Black Box	43
Appendix D: Specifications	44

1. Overview

1.1 Introduction

The ServSwitch™ Brand CAT5 KVM Extender Local Hub products described in this manual enable high-resolution video, PS/2 keyboard and mouse, stereo audio, and serial port signals to be communicated up to 300m over Category 5/5e (CATx) cable.

A basic KVM extension system comprises a *Local Unit* (transmitter) and a *Remote Unit* (receiver). The Local Unit connects directly to the computer (or a KVM switch system) using the supplied cable(s). The user *console* (keyboard, mouse and monitor) attaches to the Remote Unit. The Remote and Local Units communicate video and data information along the connecting CATx cable (see Figure 1). A Local Hub combines 6 or 12 Local Units in a rackmount chassis.

Within the product range, models are available with combinations of the following:

- Audio transmission: bi-directional stereo audio (16-bit digitized).
- Serial transmission: transparent serial COM port (to 19.2Kbps).
- Dual access: allowing a second user console at the Local Unit.

1.2 Glossary

The following terms are used in this guide:

<i>CATx</i>	Any Category 5, 5e, 6 or higher cable.
<i>PSU</i>	Power Supply Unit.
<i>KVM</i>	Keyboard, Video and Mouse.
<i>Console</i>	A keyboard, monitor, and mouse, plus optional serial devices.
<i>Dual Access</i>	A system allowing connection of local and remote user consoles.
<i>Single Head</i>	An extender system that supports one monitor.
<i>Dual Head</i>	An extender system that supports two monitors.
<i>Quad Head</i>	An extender system that supports up to four monitors.

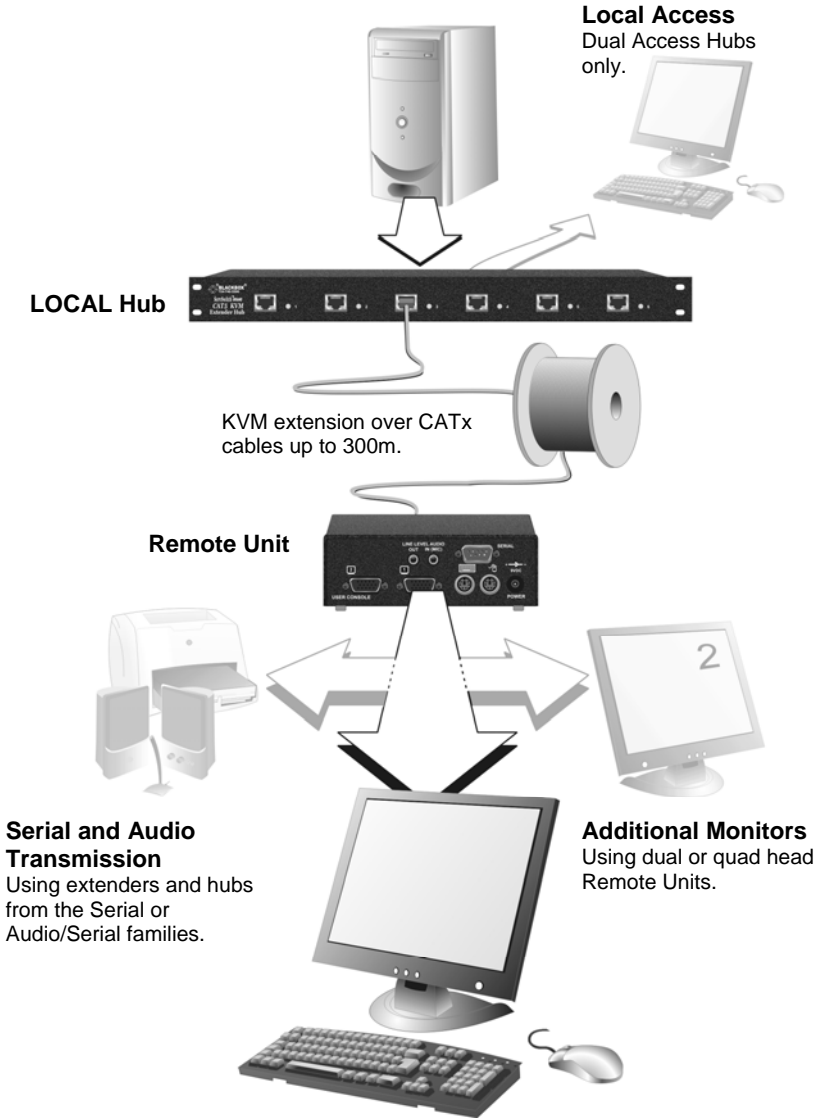

Figure 1

ServSwitch™ Brand CAT5 KVM Extender Local Hub system

1.3 Features

All members of the ServSwitch™ Brand CAT5 KVM Extender Local Hub product family offer the following features:

- Support for high video resolution over extended distances.
- Fully buffered signals to ensure consistent remote operation of your PC.
- Intelligent PS/2 keyboard and mouse emulation ensures PCs do not lock-up and allows peripherals to be hot-plugged.
- Dual-Access models allow local or remote operation.
- DDC emulation in Local Unit ensures compatibility for all standard graphics modes (when used with DDC capable CPU cables).
- *Serial (no Audio) versions only*: Serial port enables any serial device to be extended (at 1.2K, 9.6K or 19.2K Baud).
- *Audio/Serial versions only*: Transparent serial port enables any serial device to be extended (up to 19.2K Baud). The serial port may be used to extend one device (requiring handshaking lines), or up to three simple serial devices (no handshaking).
- *Audio/Serial versions only*: Bi-directional stereo audio (16-bit digitized) support on certain models enables high-quality audio extension.
- Each port is normally powered individually by the connected PC. A 5V DC PSU (supplied) is required for video/serial only applications.
- Private Mode on dual-access models allows user to lock out other console.
- Rack mount chassis (1U or 2U).
- Surge protection on each RJ45 port.
- Each port uses its own separate circuit board to enhance reliability.
- Local Hubs are fully compatible with ServSwitch™ Brand CATx and CAT5 Remote Units belonging to the same family (standard, serial or audio/serial).

1.4 Product Range

There are seven products in the ServSwitch™ Brand CAT5 KVM Extender Local Hub range:

KVM Extension Only

ACU1006RA	6 x Single Video Channel, PS/2 KB & Mouse (Single Access)
-----------	---

ACU1006DRA	6 x Single Video Channel, PS/2 KB & Mouse (Dual Access)
------------	---

ACU1012RA	12 x Single Video Channel, PS/2 KB & Mouse (Single Access)
-----------	--

KVM and Serial Extension

ACU1006SRA	6 x Single Video Channel, PS/2 KB & Mouse, Serial (Single Access)
------------	---

ACU1006DSRA	6 x Single Video Channel, PS/2 KB & Mouse, Serial (Dual Access)
-------------	---

KVM, Audio and Serial Extension

ACU1006VRA	6 x Single Video Channel, PS/2 KB & Mouse, Serial, Stereo Audio (Single Access)
------------	---

ACU1006DVRA	6 x Single Video Channel, PS/2 KB & Mouse, Serial, Stereo Audio (Dual Access)
-------------	---

1.5 Compatibility

Interface Compatibility

- **PS/2 Keyboard:** Compatible with all standard keyboards. Certain keyboards with enhanced features may also be supported with custom firmware.
- **PS/2 Mouse:** Compatible with all standard 2-button, 3-button and wheel mice. To connect to a PC that does not have a PS/2 mouse port, an active serial converter is required - Model: AC244A.
- **Audio:** Input and output are line-level. Amplified speakers are required. A microphone may be directly connected to the Remote Unit (optional pre-amplification).
- **Serial:** *Serial Only Hubs:* User selectable baud rates: 1.2K, 9.6K or 19.2K. *Audio/Serial Hubs:* Transparent up to 19.2K Baud (38.4K operation may be possible with some devices). The following serial signals are extended: TX, RX, RTS, CTS, DTR, DSR. In rare cases, a wiring adaptor may be required to transfer RI and DCD.
- **Video:** VGA to SXGA. Separate sync, composite sync, or sync-on-green. Maximum resolution and refresh rates depend on cable length and cable type.

Extender Compatibility

You can use ServSwitch™ Brand products belonging to the same family in any combination. However, it is not possible to mix Standard, Serial and Audio products within a system.

<i>Local Hub</i>	<i>Family</i>	<i>Compatible Remote Units/Hubs</i>
ACU1006RA ACU1006DRA ACU1012RA	Standard	ACUMREM (also Micro Extender Remote Units supplied with ACU3001A and ACU3009A kits) ACUREM ACUREMSW (also Remote Units supplied with ACU1001A, ACU1009A and ACU1049A kits) ACU1006MRA ACUR001A ACUR002A ACUR004A (also Remote Units supplied with ACU2001A, ACU2009A, ACU2209A and ACU2201A-R2 kits)
ACU1006VRA ACU1006DVRA	Audio	ACUWREM (also Micro Extender Remote Units supplied with ACU3022A kit) ACUVREM (also Remote Units supplied with ACU1022A and ACU1028A kits) ACU1006MRVA ACURA001A ACURA002A ACURA004A (also Remote Units supplied with ACU2022A, ACU2028A, ACU2228A and ACU2222A-R2 kits)
ACU1006SRA ACU1006DSRA	Serial	ACUSREM (also Remote Units supplied with ACU1002A and ACU1008A kits)

1.6 How to Use This Guide

This guide describes the installation and configuration of the ServSwitch™ Brand CAT5 KVM Extender Local Hub range. Although the connection and operation of these systems is relatively straightforward, you should consider the following before getting started:

Connection & Compatibility

You will require cables to connect your CPUs to the Extender Local Hub.

<i>Order Code</i>	<i>Description</i>
EHN230D-xx	CPU KVM Combination Cable (DDC Compatible)
BC00200 / BC0023x	Serial Cable 9-way D (Male-Female)
EJ110-xx	3.5mm Audio Cable (Male-Male)

xx = length. Various lengths are available. Contact technical support for details.

Ensure that the Remote Units you intend to use are compatible with your Extender Local Hub (see **Extender Compatibility**, page 15).

For information about connection and installation, see **Installation**, page 17.

Interconnection Cable

You will need CATx cable, terminated with RJ45 plugs, to connect the Local Hub to your Remote Units (see **Interconnection Cable Requirements**, page 18).

Adjusting Video

Video signals become distorted when transmitted over CATx cables. To get the best from your extender system, it is *essential* that you adjust the Remote Unit to optimize the video image quality. Please refer to the **Remote Unit Configuration & Operation** section in the manual supplied with your Remote Unit.

2. Installation

For first-time users, we recommend that you carry out a test placement, confined to a single room, before commencing full installation. This will allow you to identify and solve any cabling problems, and experiment with the KVM Extender Local Hub system more conveniently.

2.1 Package Contents

You should receive the following items in your extender package. If anything is missing, please refer to **Appendix C: Calling Black Box**, page 43.

- KVM Extender Local Hub unit.
- 5V DC PSU and power cable.
- Quick Start Guide.

2.2 Interconnection Cable Requirements

To connect the Local and Remote Units you will need CATx (any category 5, 5e, 6 or higher) cable terminated with RJ45 plugs. Please note that shielded cable is advised to maintain regulatory EMC compliance.

Interconnect cables must be solid-core type. Stranded patch cable will give poor results over longer distances. The pairing of the cable and pinning of its connectors should normally be in accordance with EIA-568B. The following table illustrates which RJ45 connector pins the extenders use for various signals. It also details the standard EIA-568B wiring scheme that is recommended for most installations.

Looking into the RJ45 socket, Pin 1 is on the right and Pin 8 on the left.

<i>Pin*</i>	<i>Color (EIA-568B)</i>	<i>Signal</i>
1	White/Orange	Blue Video
2	Orange/White	
3	White/Green	Green Video
6	Green/White	
4	Blue/White	Red Video
5	White/Blue	
7	White/Brown	Data
8	Brown/White	



EIA-568A wiring can also be used. Contact Technical Support for details.

With some cables, video performance may be improved by using a cross-over patch cable at each end or an alternative RJ45 pin-out.

2.3 Local Hub Installation

To install the Local Hub:

1. Switch off the PC and any peripheral devices before connection.
2. Using the combination CPU KVM cable(s), connect the keyboard, monitor(s) and mouse connectors on each computer (or KVM switch) to the corresponding connectors on a port of the Local Hub as shown in Figure 2 (Standard Hubs), Figure 3 (Serial only Hubs) or Figure 4 (Audio/Serial Hubs).

Ensure that you attach the keyboard and mouse connectors to the correct ports. The keyboard connector is purple; the mouse connector is green.



If your PC does not have a PS/2 mouse port, an active serial converter will be required - Model No: AC244A.

3. If you have a dual access system, connect the keyboard, mouse and monitor for the Local Hub consoles to the appropriate ports on the Local Hub. The ports may also be used to feed into a KVM switch.
4. If you have an audio-enabled Hub, connect the audio cables between the computer and Local Hub ports as follows:

<i>Computer</i>	<i>Local Hub</i>
Audio Out (green)	Audio In
Audio In/Microphone (pink/blue)	Audio Out

5. If you have a serial-enabled Hub, connect the supplied serial cable between the serial ports on the computer and the Local Hub port.
6. Connect the INTERCONNECT socket on each port of the Hub to the appropriate Remote Unit using CATx cable (see Figure 5).



Please refer to the manuals supplied with your Remote Units for information about their configuration and installation.

7. Power up the PCs, Remote Units and consoles.



The Local Hub normally takes power through each PC's keyboard port. In video/serial only applications, this connection is not used and the 5V PSU is required.

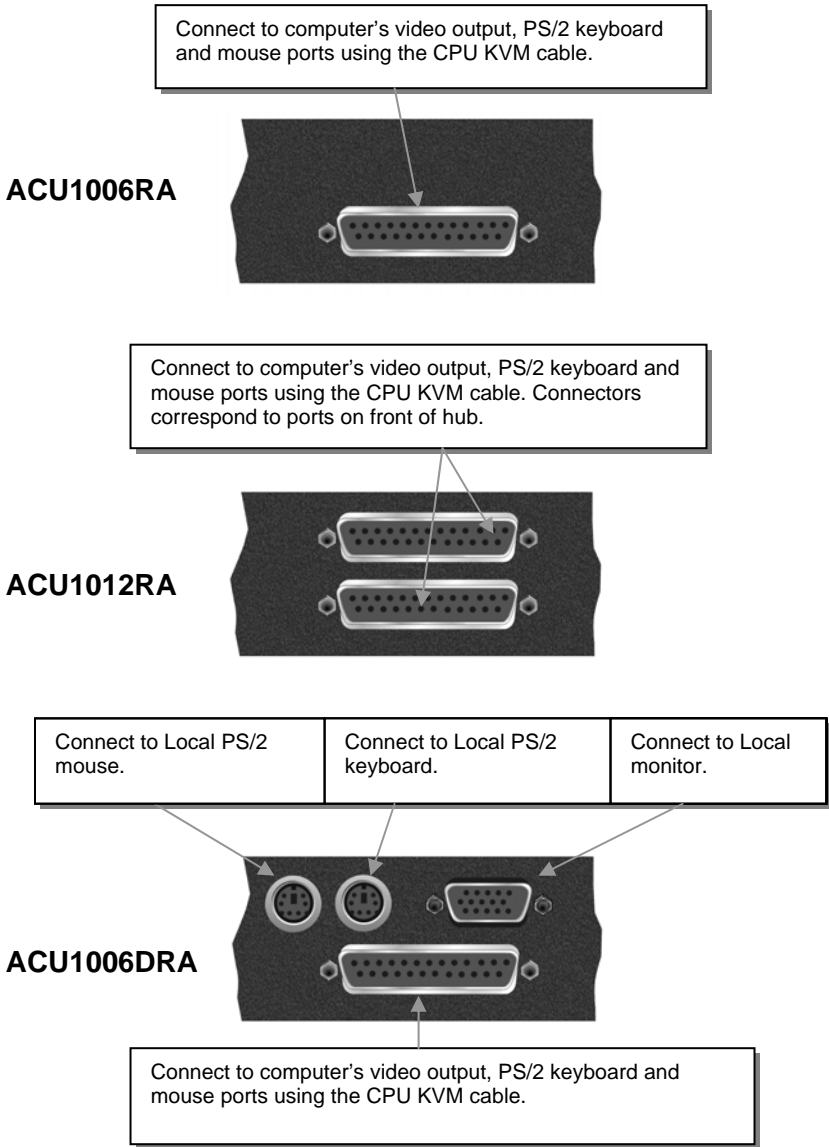

Figure 2 **Standard Hub Port - rear view**

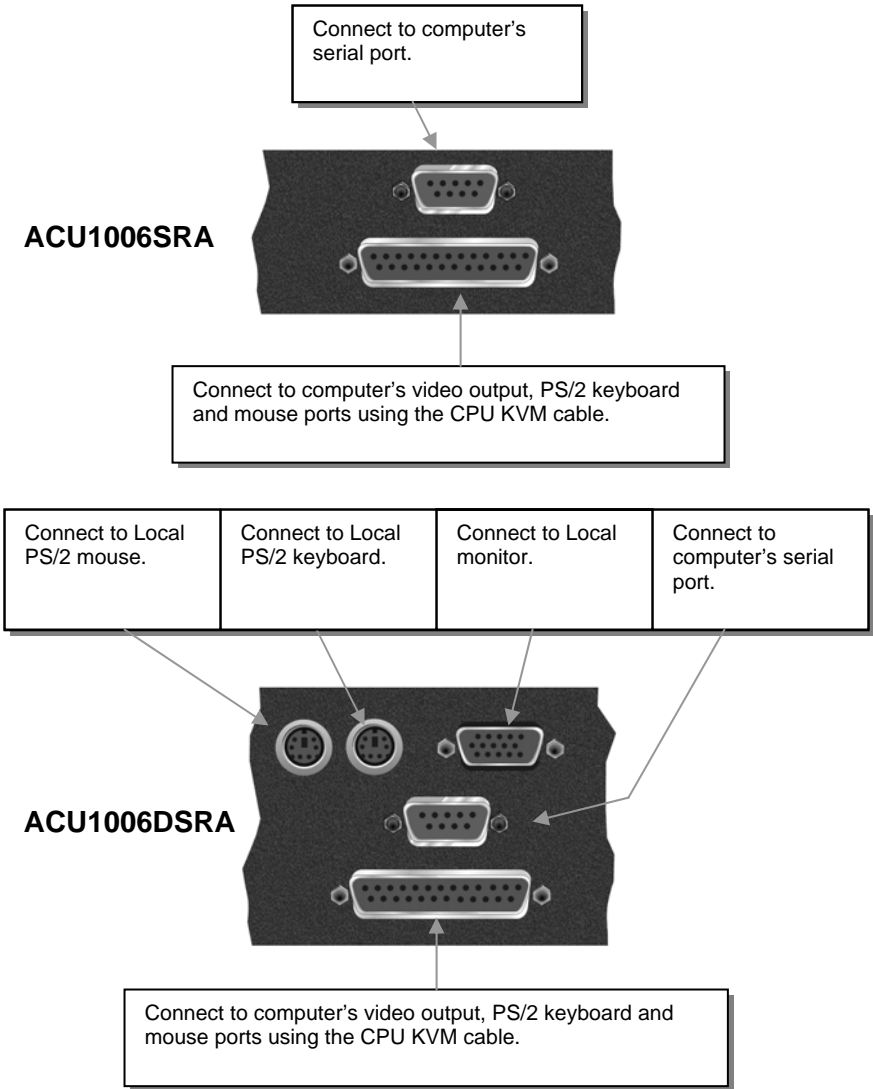

Figure 3 Serial Hub Port - rear view

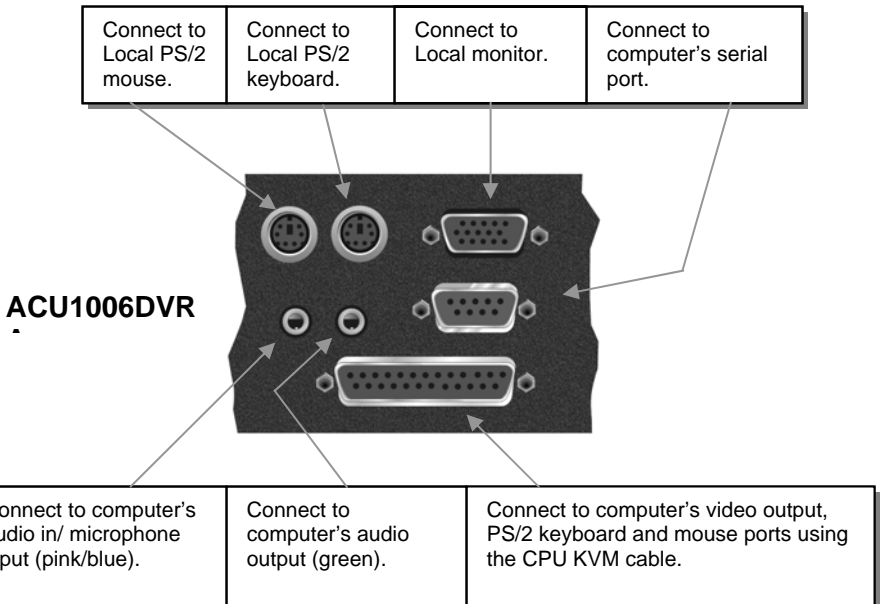
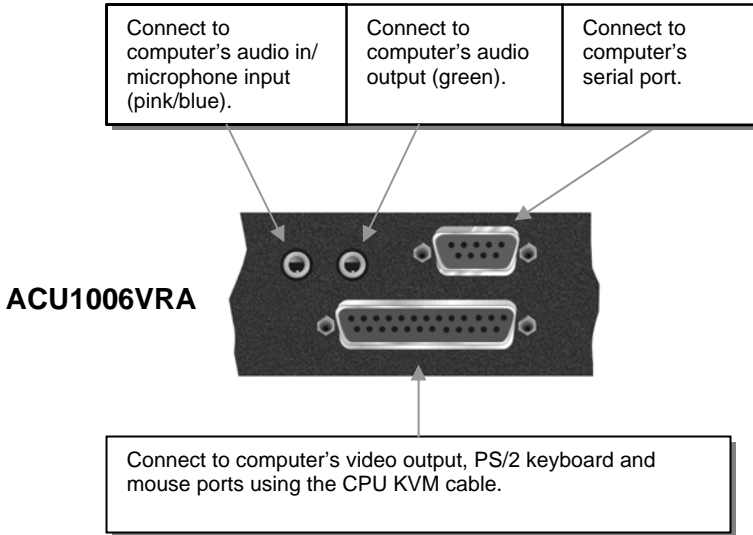

Figure 4 Audio/Serial Hub Port - rear view

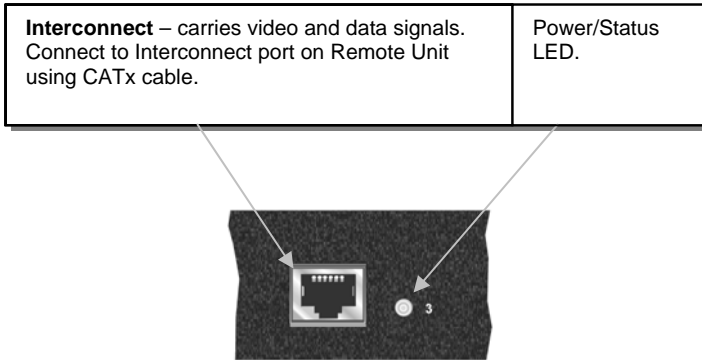

Figure 5 Hub Port - front view

Power Requirements



In most cases, there is no need to connect the 5V PSU supply as each port independently takes its own power from the PS/2 keyboard connection to the host computer.

Each Local Hub port normally takes power through the PS/2 keyboard connection to the host computer. If any ports are used for video/serial only applications, the external 5V PSU (supplied) should be connected to power the rack.

The green LED beside each Hub port indicates the power status of the port, and the integrity of the CATx connection:

- | | |
|----------------------------|---|
| <i>LED off</i> | Port not powered or keyboard PS/2 cable to Local Unit disconnected. |
| <i>LED on continuously</i> | Remote Unit not powered, CATx cable disconnected, or PC in BIOS boot sequence.
<i>Dual Access Hubs only:</i> local console active. |
| <i>LED flashing</i> | Remote Unit powered, data link operating correctly. |



NEVER CONNECT A REMOTE UNIT'S POWER SUPPLY TO A LOCAL HUB. THIS COULD DAMAGE THE EXTENDER SYSTEM.

3. Operation

3.1 Overview

The operation and configuration of dual access Standard, Serial and Serial/Audio enabled systems is slightly different. Please read the appropriate section for your system.

Dual Access, with consoles at both the Remote Unit and Local Hub port, operates on a first-come, first-served basis. When one console is in use, the system blocks out the other console until there is no keyboard or mouse use at the active console for a set time: the *Inactivity Timeout Period*. Thereafter, any keyboard (and, optionally, mouse) action at the other console switches activity.

Local Hubs offering dual access allow the user to lock out the remote console by triggering a 'Private Mode' function. This prevents the remote console from being used even if the inactivity timeout period expires.

For more information about serial/audio port operation, **Appendix B: Audio/Serial Ports**, page 38.

Keyboard and Mouse Emulation

Each port on a Local Hub has keyboard and mouse emulation. The attached PC operates normally without requiring a keyboard or mouse to be attached to either the Remote Unit or Local Hub (in the case of a dual access system). You can therefore replace any keyboard or mouse attached to the extender system without disrupting the operation of the computer.

3.2 Operation of Dual Access Standard & Serial Local Hubs

ACU1006DRA and ACU1006DSRA only

Scroll Lock Function

Standard and Serial Remote Units redefine the function of the Scroll Lock key for use within the Extender system.

You may need normal Scroll Lock activity for a specific application. In this case, you can restore the Scroll Lock key to its usual function. In doing so, you will disable Private Mode operation on a dual access system. In addition, if you need to reset/recover a console's keyboard and mouse, you may need to reboot the Remote Unit or the CPU.

Please refer to the manual supplied with your Remote Unit for more details about Scroll Lock key functions and configuration.

Console Switching

With Standard and Serial Extender systems, you can set the Inactivity Timeout Period to 2 seconds (the default) or 15 seconds. You can also choose the method of switching between consoles:

- Any detected keyboard action (the default), or
- Any keyboard or mouse action.

Please refer to the manual supplied with your Remote Unit.



When the PC is booted, the local console is active.

When you are activating a console, the first key or mouse button action is not passed to the PC.

ACU1006DSRA only: *Serial communication across the Extender system continues even when the local console is active or in a Private Mode session (see below).*

Local Console Commands

On a dual access system, you can issue the following commands at the local console:

<i>Command</i>	<i>Key Sequence</i>
<i>Activate Console</i>	Any key and (optionally) mouse action

Gain control of CPU from remote console. Only operates if inactivity timeout period has expired.

<i>Start/End Private Mode</i>	<i><Scroll Lock></i>
-------------------------------	----------------------------

Start/End 'Private Mode' at local console. Private Mode prevents the remote console from being used even if the inactivity timeout period expires.

During a Private Mode session, the extender system:

- Lights the Scroll Lock LED on the local keyboard.
- Lights the Scroll Lock LED on the remote keyboard.
- Locks the remote console's keyboard and mouse.
- Displays a blank image on the remote console's monitor. With ACUREM and ACUSREM Remote Units, you can disable this feature by setting switch 1 on the SW1 DIP switch block on the Remote Unit's main circuit board to ON. In this case, the remote monitor will continue to show PC activity during a Private mode session.
- Switches remote CPU (*ACUREMSW only*).

To end a Private Mode session, press the Scroll Lock key on the local console a second time. Remember that each press of the local console's Scroll Lock key also resets the keyboard and mouse.

<i>Reset Local Keyboard and Mouse</i>	<i><Scroll Lock></i> <i>press key twice to avoid starting/stopping Private Mode session</i>
---------------------------------------	--

Reset the local console's keyboard and mouse.

<i>Mouse Recovery</i>	<i>Hold down Left and Right Mouse buttons then press and release <Scroll Lock></i>
-----------------------	--

Use this command if you experience erratic movement of the mouse pointer or you have lost mouse movement after hot plugging the Local Unit into the CPU. In the case of erratic mouse movement, you may need to enter the command a number of times to re-synchronize the mouse signal. Alternatively, stop moving the mouse for a few seconds and the operating system's mouse drivers may automatically re-synchronize the signal. If the Local Unit has been hot-plugged, this command will issue a request to the OS to initialize the mouse. *Use this command with care.*

3.3 Operation of Dual Access Audio/Serial Local Hubs

ACU1006DVRA only

The 'Hot' Key

With these systems, keyboard 'hot' keys are used to carry out various functions.

To enter these commands:

1. Press and release the initial 'hot' key.
By default, the initial 'hot' key is **<Right Control>**

Press and release the command key.

With these systems, the Scroll Lock operates as normal unless you have pressed the initial hot key.



*You can change the Hot Key to **<Left Control>**. Please refer to the manual supplied with your Remote Unit for more details about Hot Key configuration.*

Console Switching

With Audio/Serial models, the Inactivity Timeout Period is fixed at two seconds. Thereafter, any keyboard or mouse action at the other console switches console activity.



When the PC is booted, the local console is active.

When you are activating a console, the first key or mouse press is not passed to the PC.

When the local console is in Private Mode, all audio/serial transmission is stopped.

Local Console Commands

After pressing the initial ‘hot’ key on the local keyboard, you can issue a number of commands by pressing additional keys. These commands allow you to start a private mode session on the local console or to reset the keyboard and mouse.



These commands only apply to ACU1006DVRA Local Hubs having firmware versions ‘S50’ and above.

Command

Key Sequence

Private Mode

<Scroll Lock>

Lock out the remote console by triggering a ‘Private Mode’ function. This prevents the remote console from being used even if the two second inactivity timeout period expires.

During a Private Mode session, the extender system:

- Flashes the Scroll Lock LED on the local keyboard.
- Illuminates all three LEDs on the remote keyboard.
- Displays a blank image on the remote console’s monitor.
- Locks the remote console’s keyboard and mouse.
- Stops audio transmission.

Reset Local Keyboard and Mouse

<Num-Pad Up Arrow>

Reset the local console’s keyboard and mouse. You may need to do this if you have hot-plugged a keyboard or mouse and it has not initialized correctly.

Mouse Recovery

<Num-Pad Left Arrow>

Use this command if you experience erratic movement of the mouse pointer or you have lost mouse movement after hot plugging the Local Unit into the CPU. In the case of erratic mouse movement, you may need to enter the command a number of times to re-synchronize the mouse signal. Alternatively, stop moving the mouse for a few seconds and the operating system’s mouse drivers may automatically re-synchronize the signal. If the Local Unit has been hot-plugged, this command will issue a request to the OS to initialize the mouse. *Use this command with care.*

4. Troubleshooting

4.1 Video

The image is not sharp, or is badly smeared.

Check the Interconnect cable between the Remote Unit and Local Hub. Is it of the recommended type (see page 16)? Is it intact along its entire length and securely connected at both ends? Is it wired correctly?

Ensure that all video connections throughout the system are attached securely.

Are you using an LCD panel? You need to adjust its clock and/or phase.

Refer to the manual supplied with your Remote Unit.

Colors appear to be separated and there are colored borders on text and icons.

Check the Interconnect cable between the Remote Unit and Local Hub. Is it of the recommended type (see page 17)? Is it intact along its entire length and securely connected at both ends? Is it wired correctly?

Are you using low skew cable?

You may need to use a skew reduction technique. Refer to the manual supplied with your Remote Unit.

I only need video extension – not keyboard or mouse - but I can't get a picture

Have you powered the Local Hub? Each Local Hub port gets its power from the CPU through the keyboard connection and it will not operate without it. Use an external 5V PSU as described on page 23.

The monitor sometimes goes blank for a second or two.

Check that the interconnect cable is not routed near power lines or other sources of electrical interference. Use shielded STP/FTP cable instead of UTP cable ensuring that the shield connection is maintained between the Extender Units.

Check system grounding. If your remote monitor has an external PSU you may need to consider grounding the Remote Unit chassis (to power ground).

If this is a persistent problem, contact Technical Support.

The PC won't boot into the correct graphics mode

The extender includes DDC emulation for all standard resolutions and there should not normally be any issues. However, you must be using DDC capable CPU cables on each hub port.

For non-standard resolutions, you will need to explicitly set the resolution in your operating system configuration ignoring the DDC data read from the Local Unit.

Contact Technical Support if you have problems selecting your required graphics mode.

The image is not stable and is blanking regularly.

Re-power the Remote Unit.

Can the extender be used with RGB video?

Yes.

4.2 Audio

The audio is very quiet.

The audio I/O is line-level and requires amplified speakers and connection to devices providing line-level I/O.

The audio is loud but distorted.

Check that the audio input is not greater than line level (4V peak-to-peak). KVM Extenders accepts line-level audio input only.

The microphone output is barely audible.

See **Appendix B: Audio/Serial Ports**, page 38.

4.3 Serial

My serial device does not function.

The extender supports serial devices at data rates not exceeding 19.2K Baud (although 38.4K operation might be possible with certain equipment).

Check the type of flow control used by the device and CPU. The extender supports RTS, CTS, DTR, and DSR. Some systems may require a wiring adapter to transfer RI and DCD.

Attach the device directly to the serial port on the PC and test whether the problem is a PC or extender problem.

Some serial devices cannot be hot-plugged. Try connecting the device to a powered Remote Unit prior to booting the system.

4.4 Keyboard & Mouse

When I am typing, I get wrong or missing characters on the screen.

Your keyboard may be in the wrong mode. Use the appropriate commands to reset the keyboard and mouse as described in the manual supplied with your Remote Unit.

The PC comes up with 'keyboard error'.

Press <F1> or <ESC>. If the keyboard now operates correctly, you need to adjust the BIOS setup to disable keyboard testing during booting.

The system does not detect a PS/2 mouse.

If connecting a Local Hub port to a live system, connect the mouse cable to the CPU *before* keyboard connection to ensure the mouse is enabled correctly. Try issuing the Mouse Recovery command.

Check that the mouse cable is connected properly and securely. Reboot the system.

The mouse pointer moves erratically.

Reset the keyboard and mouse as described in the previous sections.

Issue the Mouse Recovery command up to three times.

Ensure that you have the latest driver for your mouse.

If you are using the Hub port with a KVM switch, command the switch to reset the mouse.

Quit and restart the application.

Reboot the PC.

When I 'hot-plug' the Local Hub port, the mouse no longer moves.

When connecting a Hub port to a live system, connect the mouse cable to the CPU before keyboard connection to ensure the mouse is enabled. Try issuing the Mouse Recovery command.

Some of the mouse buttons don't work.

The Extenders support standard 2/3-button mice (with or without a wheel).

Additional buttons will not operate.

I have an enhanced keyboard with extra keys and indicators. Everything works apart from these additional features.

The extender emulates a generic PS/2 keyboard. To support other keyboards (or cascaded KVM switches), special firmware offering a *transparent mode* may be required. Please contact Technical Support to discuss your application.

4.5 General Questions

Is it possible to use a cable longer than 300m?

It might be possible to use a cable of up to 500m at lower resolutions. However, we do not recommend this and cannot guarantee that it will work.

Can the extender be daisy chained?

In certain circumstances, it is possible to cascade extenders, though we do not recommend doing so. Careful consideration needs to be given to extender setup, and the electrical environment. If you plan to cascade extenders, please contact Technical Support.

Which interconnection cable is best?

The extender will operate with either shielded (STP/FTP) or unshielded (UTP) CATx cable. However, correctly installed shielded cable is preferred, especially in electrically noisy environments, because it resists interference more strongly, limits ground potential differences, and reduces emissions. To benefit from shielded cable the shield connection *must* be maintained from end to end through any intervening patch cables, panels and RJ45 connectors.

Please note that shielded cable is advised in order to maintain regulatory EMC compliance.

Can the extender system be used between buildings?

No. Ground loops could damage the extender system and attached equipment.

Can multiple Local/Remote Units be used by swapping the interconnection cable?

Local Hubs provide full keyboard and mouse emulation, so it is possible to swap or switch the local-remote interconnection to create a KVM matrix-switch system. Sometimes you may need to reset the keyboard and mouse (by entering the appropriate command) after a swap or switch. Please call Technical Support before deploying such a system.

Can the extender be connected into our network?

Absolutely not. Regardless of the cable similarities, the data signals and voltages used by the extender are different from those used by Ethernet and other types of networks. Connecting the extender to a LAN hub, switch, repeater, or other network device, or exposing it to the signal levels present on network data lines may damage the extender and other devices.

Appendix A: Example Applications

This section illustrates four specific applications using ServSwitch™ Brand CAT5 KVM Local Hubs:

- Simple system using ACU1006VRA Hub and ACUVREM Remote Units to extend audio, serial and KVM for up to six PCs (Figure 6)
- Six remote serial touch screens with local access through a KVM switch (Figure 7).
- Information distribution system sharing a single PC at up to six remote locations (Figure 8).
- Dual-monitor consoles with serial and audio extension (Figure 9).

For more information about these, or any other complex applications, please discuss suitable extension architecture with Technical Support.

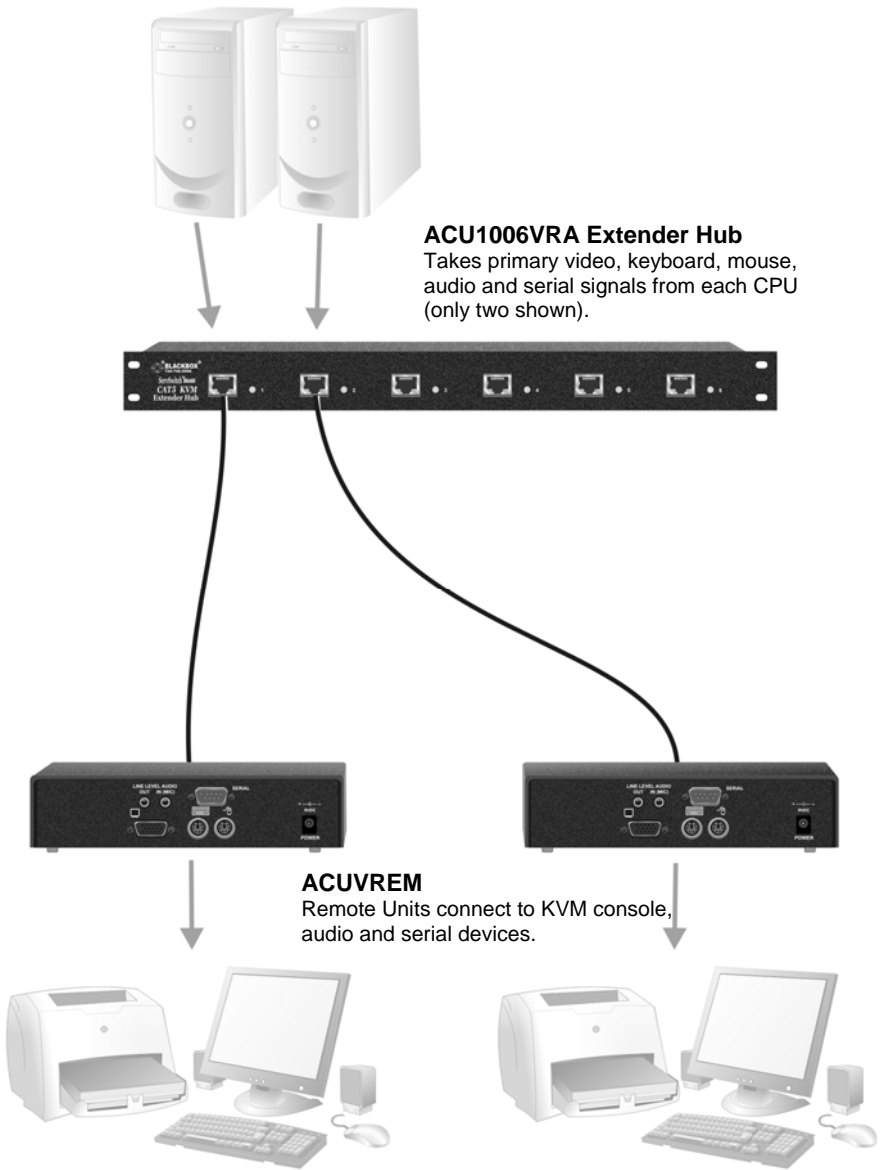

Figure 6 Serial and audio extension for up to six CPUs

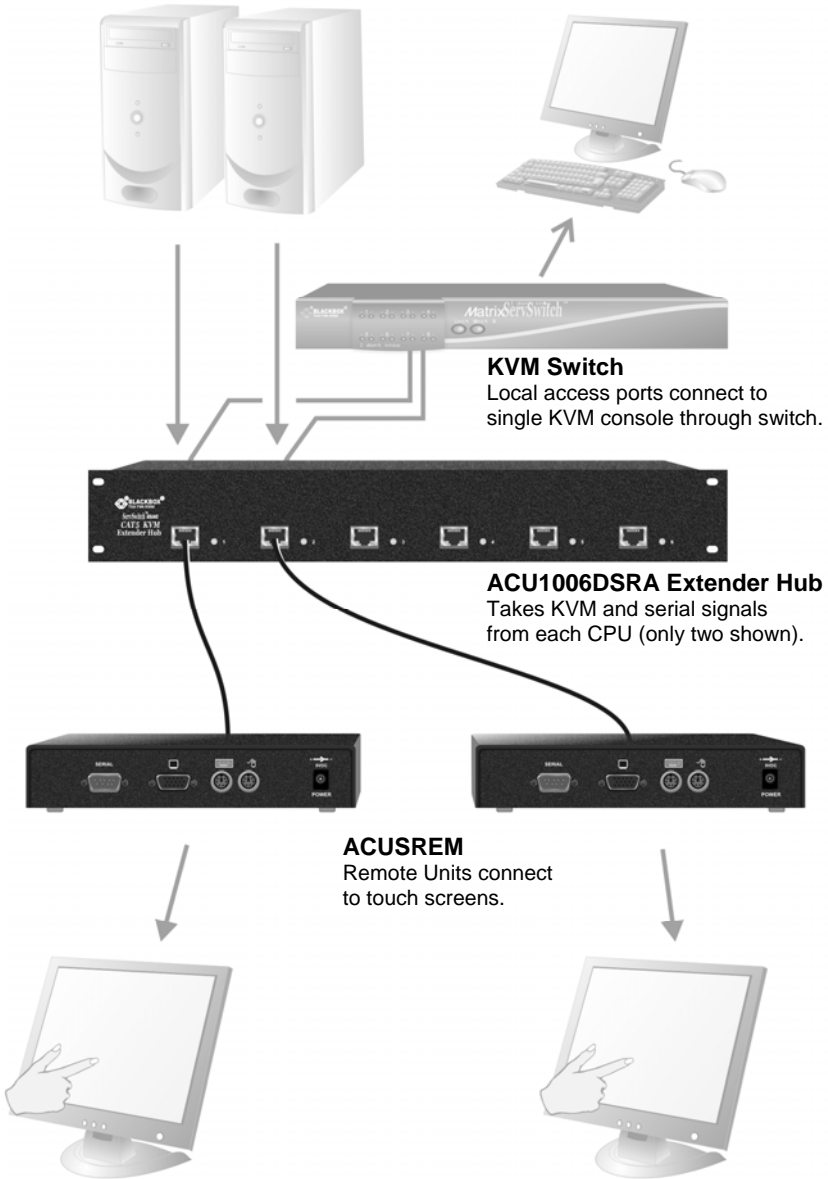

Figure 7 Touch screen network with local access to CPUs through KVM switch

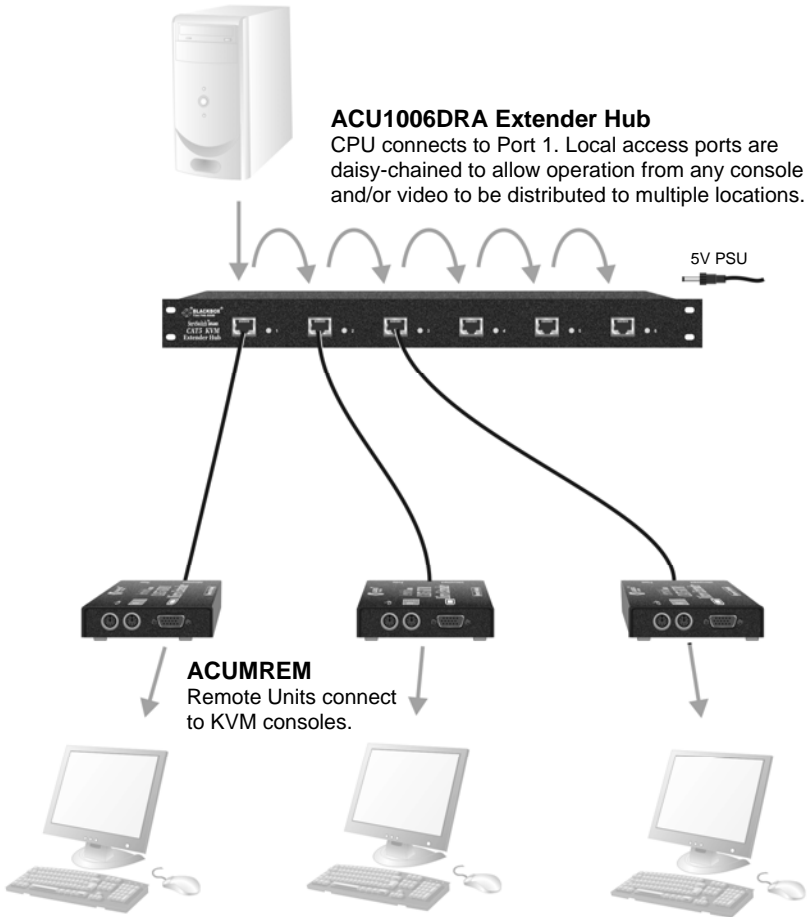

Figure 8 Information distribution system sharing a single PC

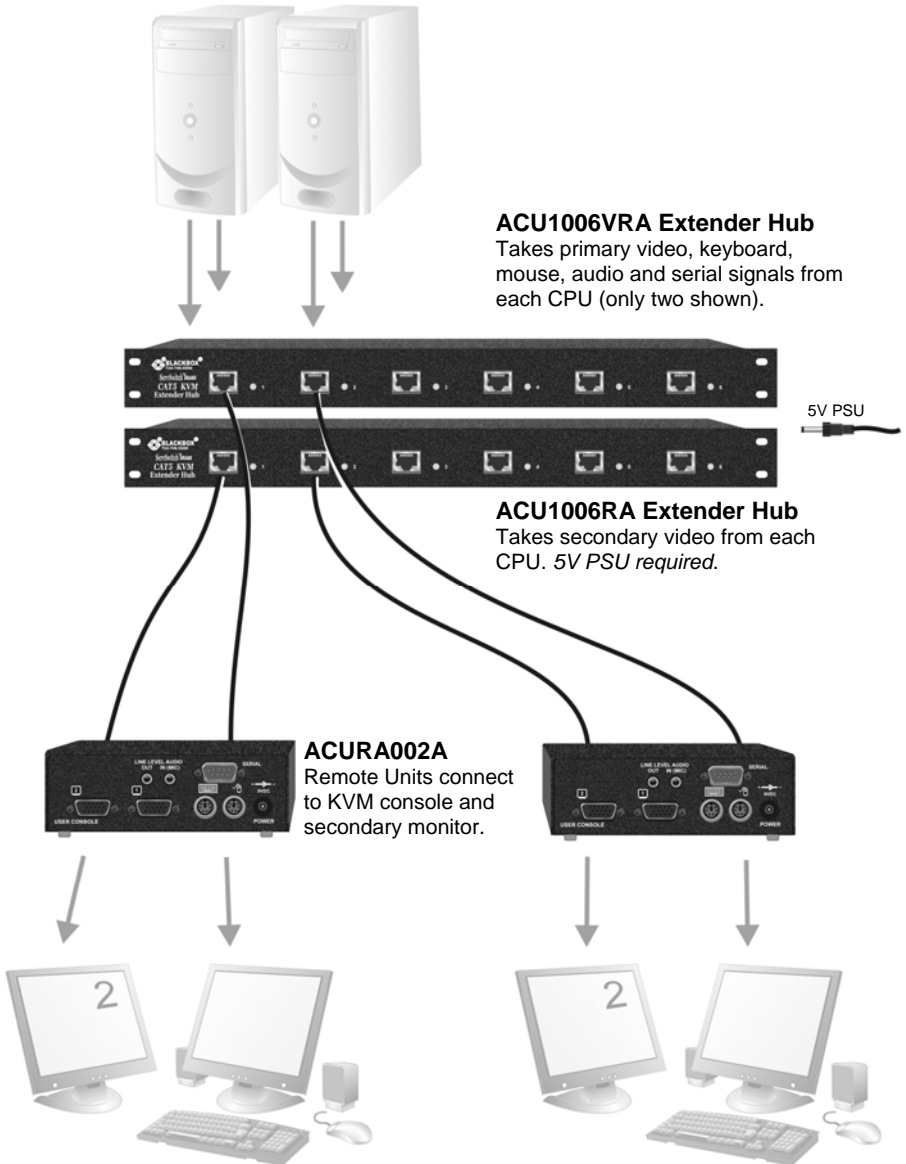

Figure 9 Dual-monitor consoles with serial and audio extension

Appendix B: Audio/Serial Ports Operation and Multi-Port Configuration

This appendix describes audio & serial interface operation for:

- ACU1006SRA and ACU1006DSRA
- ACU1006VRA and ACU1006DVRA

Please note that on dual access Local Hubs, the serial link remains active during a Private Mode session but audio transmissions are stopped.

Serial Interface Setup and Operation

Serial only systems ACU1006SRA and ACU1006DSRA

Baud Rate

With serial-only systems, you can set the baud rate for a serial extension to 9600bps or 19200bps at the Remote Unit. Refer to the manual supplied with your Remote Unit for more information.

You can override this setting and fix the baud rate at 1200bps using a jumper on the serial daughterboard in the Local Hub. You may want to use this baud rate to extend a mouse device such as an industrial trackball.

In most cases, we recommend that you use PS/2 mouse devices with your extender system. If you have a PC that does not have a PS/2 mouse port:

- Plug a PS/2 mouse into the Remote Unit
- Use an Mdapt (PS/2) Serial Mouse Converter to connect the PC to your Local Unit.



The drivers supplied with certain Wacom Graphics Tablets dynamically alter the baud rate and cannot be used with an Extender Local Hub. There is a version of the driver available with a fixed baud rate. Please contact Technical Support for more information.

To change the baud rate to 1200bps:

2. Remove the Local Hub's top cover by unfastening the five retaining screws.
3. Lift off the top cover. There are six serial daughter boards for each port in the Local Hub. Locate the *Baud* jumper posts on the appropriate serial daughter board (see Figure 10).



The circuit board has several jumper blocks in addition to those shown in Figure 10. Do not adjust any of these settings, as you will cause the extender system to operate incorrectly.

4. Place the jumper across the posts as shown in Figure 11.
5. Set the hardware flow control jumpers to *RTS/CTS Flow Control Across CATx Link* as shown in Figure 12. This mode will support most, but not all, serial mouse and trackball devices.

You must also configure the Remote Unit to use this protocol. Refer to the manual supplied with your Remote Unit.

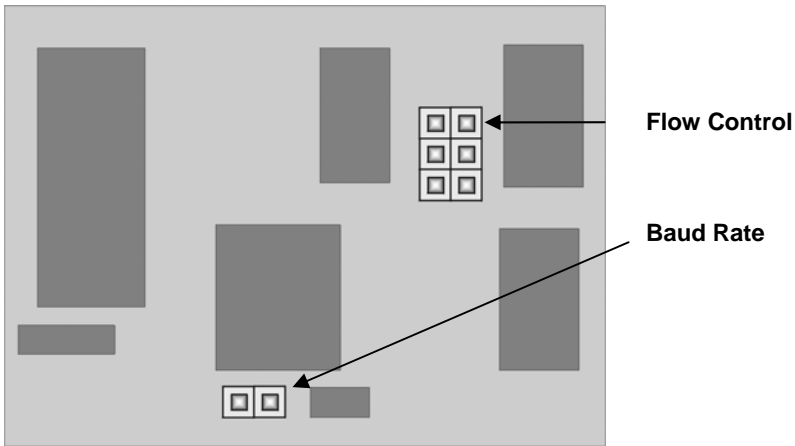

Figure 10 Position of Baud Rate and Flow Control jumper blocks on Serial Daughter Board

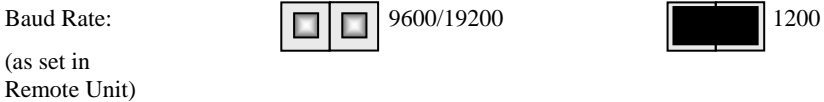

Figure 11 Baud Rate Jumper Settings in Local Hub (see Figure 10 for location of jumper block)

Hardware Flow Control

The serial daughterboards in both Local Hub and Remote Units have a series of jumpers that allow the selection of alternative hardware flow control schemes across the CATx link (see Figure 10). Most applications will not require hardware flow control across the link, and therefore the flow control jumpers are set to loopback by default and should not need adjustment.

The following diagrams show how the jumpers may be set for various flow control schemes. Please contact Technical Support if you are unsure about serial port handshaking methods.

No hardware handshaking

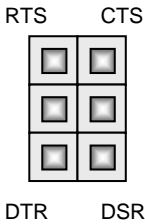

RTS/CTS and DTR/DSR loopback - default

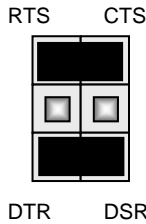

DTR/DSR Flow Control Across CAT5 Link

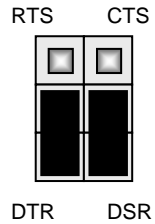

*RTS/CTS Loopback
DTR/DSR Flow Control
(Printer)*

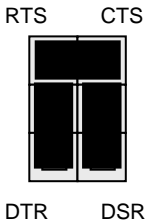

*RTS/CTS Flow Control
Across CAT5 Link
(Serial mouse)*

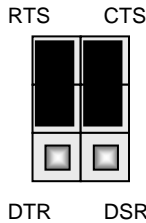

*DTR/DSR Loopback
RTS/CTS Flow Control*

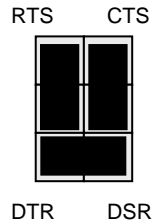

Figure 12 Jumper Settings on Flow Control block for various serial port flow control and handshaking configurations (see Figure 10 for location of jumper block)

Audio/Serial Interface Setup and Operation

ACU1006VRA and ACU1006DVRA only

Serial Port Configuration

No setting up or user adjustments are required.

In the Audio/Serial extender family, the serial port is wired as DTE - the same as that on a PC. To connect a serial printer or other DTE (rather than DCE device) to the Remote Unit, you will need a Null-Modem crossover cable between the Remote Unit and the printer. Select Xon/Xoff software flow control on the printer and PC.

A serial touch screen may be plugged directly into the Remote Unit.

Please note that on dual access Local Hubs, the serial link is always active.

Handling Multiple Serial Devices

The extender's serial interface transmits/receives six signals (3 signals in each direction).

Normally, four of these signals are used for hardware handshaking (in addition to TX & RX). However, because each handshaking line can support signals up to 19,200 Baud it is possible to configure the serial interface to handle up to three simple 2-wire (Tx/Rx only) serial links.

To do this, you will need to construct a custom breakout cable. Please contact Technical Support for further information.

Audio Port Configuration

The audio interface is line-level and is designed to take the output from a sound card (or other line-level) source and be connected to a set of powered speakers at the other end of the link.

Stereo audio may be transmitted either way across the link (simultaneously).

No setup is required unless a microphone is connected to the Remote Unit.

Connect the extender as follows:

- Take the line-level output from your sound card (green connector) and connect to 'Line In' on the Local Unit.
- Connect 'Line Out' on the Remote Unit to a set of powered speakers.

There is no output on the Local Hub to connect a set of speakers. If you require a set of speakers at the local console, use a 3.5mm stereo socket doubler on the audio input to the extender.

Using a Microphone

A microphone may be plugged into the 'Line In' connector on the Remote Unit.

There are two ways of setting up a microphone:

- The Local Hub's 'Line Out' connection should normally be wired to the microphone input (Pink) on your sound card. The sound card should then be set up to provide additional amplification (+17dB). This is the preferred connection method.
- Alternatively, the Remote Unit itself can provide microphone amplification. To set this, open up the Remote Unit and locate the jumper labeled 'MIC' on the daughter board. Connect this jumper across the pins. The Local Hub's 'Line Out' connection should then be wired to 'Line In' (Blue) on your sound card.

If your microphone is already amplified, follow the second method but **DO NOT** install the amplification jumper in the Remote Unit.

Appendix C: Calling Black Box

If you determine that your ServSwitch™ Brand CAT5 KVM Extender Local Hub is malfunctioning, **do not attempt to alter or repair it**. It contains no user-serviceable parts. Contact Black Box Technical Support at 724-746-5500.

Before you do, make a record of the history of the problem. We will be able to provide more efficient and accurate assistance if you have a complete description, including:

- The firmware-revision level printed on the bottom of the Extender Local Hub (very important, especially for keyboard and mouse problems); The KVM Extender Local Hub's firmware revision level:
Version Number Format: xxSyy/zz
xx is the hardware revision number
yy is the firmware revision number
zz is the auxiliary revision number.
- The nature and duration of the problem.
- When the problem occurs.
- The components involved in the problem—that is, what type of computers, what type of keyboard, brand of mouse, make and model of monitor, type and make of CAT5 cable, etc.
- Any particular application that, when used, appears to create the problem or make it worse.
- The results of any testing you've already done.

To solve some problems, it might be necessary to upgrade the Extender Local Hub's firmware. If this turns out to be the case for your difficulty, our Technical Support technicians will arrange for you to receive the new firmware and will tell you how to install it.

Shipping and Packaging

If you need to transport or ship your ServSwitch™ Brand CAT5 KVM Extender Local Hub:

- Package it carefully. We recommend that you use the original container.
- If you are shipping it for repair, please include everything you received with it. Before you ship the Extender Local Hub back to Black Box for repair or return, contact us to get a Return Authorization (RA) number.

Appendix D: Specifications

Video

<i>Maximum Resolution</i>	See manual supplied with Remote Unit(s)
<i>Video Compatibility</i>	VGA to UXGA, RGB
<i>Video I/O</i>	0.7V P-P
<i>Video Coupling</i>	DC
<i>Sync I/O</i>	H/V or composite TTL signal levels Sync Polarity is preserved
<i>Video Input Connectors</i>	DB25 Female (CPU KVM)
<i>Video Output Connectors</i>	HD15 (Female)

Keyboard and Mouse

<i>KB Compatibility</i>	PC/AT, PS/2
<i>Mouse Compatibility</i>	Standard PS/2 two/three button Standard wheel mice Logitech 3-button PS/2
<i>KB/Mouse Connectors (CPU)</i>	DB25 Female (CPU KVM)
<i>KB/Mouse Connectors (Device)</i>	6-Pin MiniDIN Socket

Serial Interface

<i>Max Baud Rate Supported</i>	ACU1006SRA and ACU1006DSRA: 1200, 9600 or 19200 Baud (user-selectable) ACU1006VRA and ACU1006DVRA: 19.2K Baud
ACU1006SRA and ACU1006DSRA <i>Serial Data Format:</i> <i>Flow Control:</i>	8 data bits, no parity, 1 stop bit Hardware: Either RTS/CTS passed through or looped back DTR/DSR passed through or looped back or none (user-selectable) Software: Transparent to software flow control
ACU1006VRA and ACU1006DVRA <i>Serial Data Format:</i>	Transparent
<i>Signals Transferred:</i>	TX, RX, RTS, CTS, DTR, DSR
<i>Serial Connector</i>	DB9 Female (DCE)

Audio Interface

<i>Description</i>	Bi-directional stereo audio link
<i>Transmission method</i>	Digitized virtually CD quality audio (16-bit, 38.4kHz)
<i>Signal levels</i>	Line level (4 Volts Pk-Pk maximum)
<i>Input Impedance</i>	47kΩ
<i>Audio Connectors</i>	2x3.5mm stereo jack socket (Line In & Line Out)
<i>Microphone Support</i>	Microphone may be connected to Remote Unit Pullup resistor provides bias for condenser microphone Option to set microphone amplification to +17dB

Power Requirements

<i>Local Hub</i>	5V at up to 200mA (per port). Each port powered individually by connected PC. 5V, 20W PSU supplied for video/serial only applications. 2.1mm center positive Universal supply. Certified to all relevant international safety standards.
------------------	---

Size and Shipping Weight

<i>ACU1006RA</i>	Local Hub: 482x112x44mm (1U) Shipping Weight: 2.45 Kg
<i>ACU1006DRA</i>	Local Hub: 482x112x44mm (1U) Shipping Weight: 2.65 Kg
<i>ACU1006SRA</i>	Local Hub: 482x112x44mm (1U) Shipping Weight: 2.60 Kg
<i>ACU1006VRA</i>	Local Hub: 482x112x44mm (1U) Shipping Weight: 2.65 Kg
<i>ACU1012RA</i>	Local Hub: 482x112x88mm (1U) Shipping Weight: 2.80 Kg
<i>ACU1006DSRA</i>	Local Hub: 482x112x88mm (2U) Shipping Weight: 3.56 Kg
<i>ACU1006DVRA</i>	Local Hub: 482x112x88mm (2U) Shipping Weight: 3.61 Kg

Environmental

<i>Operating Temperature</i>	0 to 40 °C
<i>Storage Temperature</i>	-30 to 65 °C
<i>Relative Humidity</i>	5-90% non-condensing
<i>Chassis Construction</i>	Fully shielded. Black painted steel

NOTES

NOTES



Customer Support Information:

Order toll-free in the U.S.: Call **877-877-BBOX** (outside U.S. call **724-746-5500**)
For FREE Technical Support 24 hours a day, 7 days a week, call **724-746-5500** or fax **724-746-0746**
Mailing address: **Black Box Corporation**, 1000 Park Dr., Lawrence, PA 15055-1018
World-Wide Web: **www.blackbox.com** • Email: **info@blackbox.com**
© Copyright 2009. Black Box Corporation. All rights reserved.