

User Manual

Edition: 2010-10-06

CATx DVI-D plus USB HID Extender

Model:

ACS3110A

ACS3210A

ACS3120A

ACS3220A

Copyright

© 2010. All rights reserved. This information may not be reproduced in any manner without the prior written consent of the manufacturer.

Information in this document is subject to change without notice.

Trademarks

All trademark and trade names mentioned in this document are acknowledged to be the property of their respective owners.

Disclaimer

While every precaution has been taken during preparation of this manual, the manufacturer assumes no liability for errors or omissions. Neither does the manufacturer assume any liability for damages resulting from the use of the information contained herein.

The manufacturer reserves the right to change specifications, functions, or circuitry of the product without notice.

The manufacturer cannot accept liability for damage due to misuse of the product or due to any other circumstances outside the manufacturer's control (whether environmental or installation related). The manufacturer shall not be liable for any loss, damage, or injury arising directly, indirectly, incidentally, or consequently from the use of this product.

Contents

1	About This Manual.....	5
1.1	Scope.....	5
1.2	Validity	5
1.3	Cautions and Notes	5
2	Safety Instructions	6
3	Description.....	7
3.1	Application	7
3.2	System Overview.....	8
3.3	Product Range	9
3.4	Rack Mount Kits.....	9
3.5	Accessories.....	9
3.6	Device Views	10
3.6.1	Model ACS3110A(Single-Head).....	10
3.6.2	Model ACS3210A(Dual-Head).....	11
3.6.3	Model ACS3120A(Single-Head)	13
3.6.4	Model ACS3220A(Dual-Head).....	14
3.7	Diagnostics	16
4	Installation.....	18
4.1	Package Contents.....	18
4.2	System Setup.....	19
4.3	Example Applications.....	20
5	Configuration	22
5.1	Transmission Parameters	22
5.1.1	Adjustment of Video Resolution.....	22
5.1.2	Adjustment of Cable Length.....	23
5.2	DDC Settings	24
5.3	Selection of Operation Mode	25
5.4	Command Mode	26
6	Operation.....	27
6.1	Readjustment of Transmission Parameters (Auto-Adjust).....	27
6.2	Download of DDC Information	27
6.2.1	Download DDC via Keyboard Command.....	28
6.2.2	Download DDC via DVI Cable	28
7	Specifications	29

CATx DVI-D plus USB HID Extender

7.1	Interfaces	29
7.1.1	DVI-D Single Link (Video source / monitor)	29
7.1.2	USB-HID	29
7.1.3	USB 2.0 (transparent)	30
7.1.4	RJ45 (Interconnect)	30
7.2	Interconnect Cable.....	31
7.2.1	Cat X.....	31
7.3	Supported Peripherals	32
7.3.1	USB-HID Devices	32
7.3.2	USB 2.0 Devices.....	32
7.3.3	Interconnect Cable (Cat X)	33
7.4	Connector Pinouts	34
7.5	Power Supply.....	36
7.6	Environmental Conditions.....	36
7.7	Size.....	36
7.8	Shipping Weight.....	37
8	Troubleshooting	38
8.1	Blank Screen.....	38
8.2	Video Jitter	39
8.3	USB-HID Failure	39
8.4	USB 2.0 Failure.....	40
9	Technical Support	41
9.1	Support Checklist.....	41
9.2	Shipping Checklist	41
9.3	BlackBox subsidiary contact details.....	42
9.4	CE Declaration Of Conformity.....	43
9.5	North American Regulatory Compliance.....	44
9.6	WEEE	44
9.7	RoHS	44
10	Glossary	45

1 About This Manual

1.1 Scope

This manual describes how to install your Extender, how to operate it and how to perform trouble shooting.

1.2 Validity

This manual is valid for all devices listed on the front page. The product code is printed on the base of the devices.

1.3 Cautions and Notes

The following symbols are used in this manual:



This symbol indicates an important operating instruction that should be followed to avoid any potential damage to hardware or property, loss of data, or personal injury.



This symbol indicates important information to help you make the best use of this product.

2 Safety Instructions

To ensure reliable and safe long-term operation of your Extender please note the following guidelines:

Installation

- Only use in dry, indoor environments.
- The Extender and the power supply units can get warm. Do not situate them in an enclosed space without any airflow.
- Do not place the power supply directly on top of the device.
- Do not obscure ventilation holes.
- Only use power supplies originally supplied with the product or manufacturer-approved replacements. Do not use a power supply if it appears to be defective or has a damaged case.
- Connect all power supplies to grounded outlets. In each case, ensure that the ground connection is maintained from the outlet socket through to the power supply's AC power input.
- Do not connect the link interface to any other equipment, particularly network or telecommunications equipment.
- Take any required ESD precautions.

Repair

- Do not attempt to open or repair a power supply unit.
- Do not attempt to open or repair the Extender. There are no user serviceable parts inside.
- Please contact your dealer or manufacturer if there is a fault.

3 Description

3.1 Application

The Extender is used to increase the distance between a source (computer, CPU) and its console (keyboard, mouse, and other peripheral devices).

The Extender is designed for use with Cat X (Twisted Pair) interconnect cables.

The Extender is unsuitable for connection between buildings where a fiber optic based product should be used instead.

3.2 System Overview

The Extender consists of a CPU Unit and a console unit (CON Unit).

The CPU Unit is connected directly to the source (computer, CPU) using the supplied cables.

The CON Unit is connected to the console (monitor, keyboard and mouse).

The CPU Unit and the CON Unit communicate with each other through the interconnect cables.

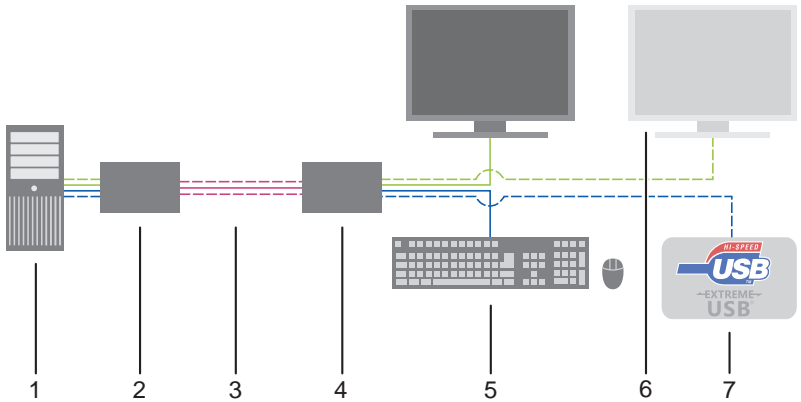

System overview

- 1 Source (computer, CPU)
- 2 Extender CPU Unit
- 3 Interconnect cable
- 4 Extender CON Unit
- 5 Console (monitor, keyboard, mouse)
- 6 Second monitor (option, only with Dual-Head devices)
- 7 USB 2.0 devices (option, only with USB 2.0 devices)



See Chapter 4.3, Page 20 for installation examples.

3.3 Product Range

Model	Description
ACS3110A	Single-Head Extender for 1x DVI Single Link (up to 1920x1200), 2x USB-HID (keyboard / mouse)
ACS3210A	Dual-Head Extender for 2x DVI Single Link (up to 1920x1200), 4x USB-HID (keyboard / mouse)
ACS3120A	Single-Head Extender for 1x DVI Single Link (up to 1920x1200), 4x USB 2.0 (transparent)
ACS3220A	Dual-Head Extender for 2x DVI Single Link (up to 1920x1200), 2x USB-HID (keyboard / mouse), 4x USB 2.0 (transparent)

3.4 Rack Mount Kits

Model	Description
ACS3000A-RMK	19"/1U rack mount kit to mount Single-Head and DualHead devices
DRMVACU-S	DIN Rail Mounting Kit to mount by snap on (Single-Head units und Dual-Head CPU Units)

3.5 Accessories

Model	Description
ACS1009A-PS-4A	International power supply unit 100...240VAC / 5VDC / 4 A
ACXSPL12	DVI-D splitter cable
EYNG3110A-030M	Cat 5e simplex cable; Leoni Kerpen; length 30 m
EYNG3110A-040M	Cat 5e simplex cable; Leoni Kerpen; length 40 m
EYNG3110A-050M	Cat 5e simplex cable; Leoni Kerpen; length 50 m

3.6 Device Views

3.6.1 Model ACS3110A (Single-Head)

CPU Unit

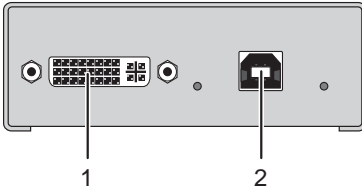

Front View

- 1 To CPU: DVI-D
- 2 To CPU: USB-HID

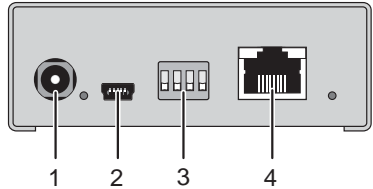

Rear View

- 1 Connect to 5VDC power supply
- 2 Service port
- 3 Configuration DIP switches
- 4 Connect to interconnect cable

CON Unit

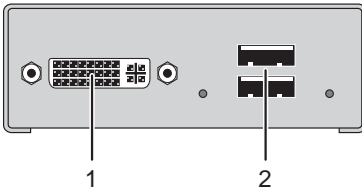

Front View

- 1 Connect to DVI monitor
- 2 Connect to USB-HID devices

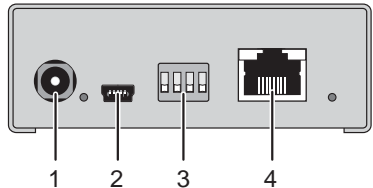

Rear View

- 1 Connect to 5VDC power supply
- 2 Service port
- 3 Configuration DIP switches
- 4 Connect to interconnect cable

3.6.2 Model ACS3210A(Dual-Head)

CPU Unit

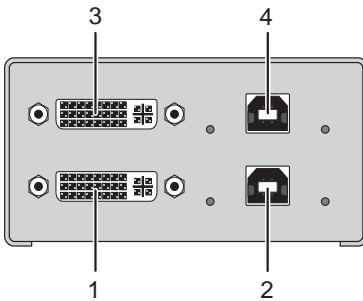

Front View

- 1 To CPU: DVI-D 1
- 2 To CPU: USB-HID 1
- 3 To CPU: DVI-D 2
- 4 To CPU: USB-HID 2

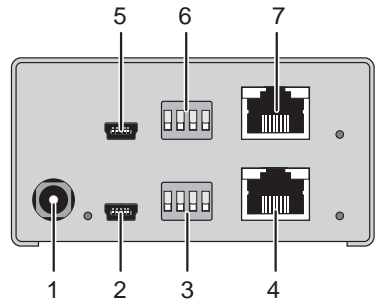

Rear View

- 1 Connect to 5VDC power supply
- 2 Service port 1
- 3 Configuration DIP switches 1
- 4 Connect to interconnect cable 1
- 5 Service port 2
- 6 Configuration DIP switches 2
- 7 Connect to interconnect cable 2

CATx DVI-D plus USB HID Extender

CON Unit

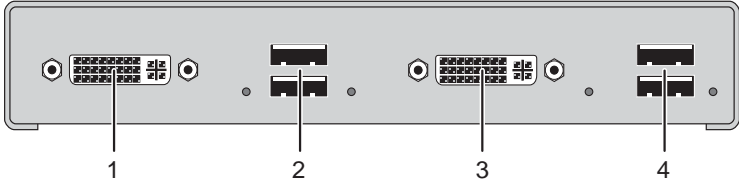

Front View

- 1 Connect to DVI monitor 1
- 2 Connect to USB-HID devices 1
- 3 Connect to DVI monitor 2
- 4 Connect to USB-HID devices 2

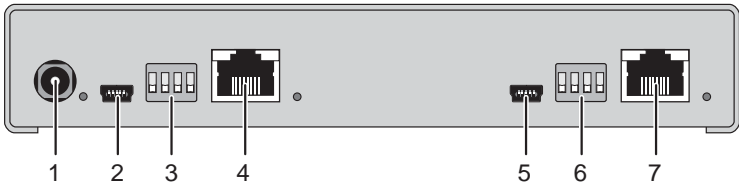

Rear View

- 1 Connect to 5VDC power supply
- 2 Service port 2
- 3 Configuration DIP switches 2
- 4 Connect to interconnect cable 2
- 5 Service port 1
- 6 Configuration DIP switches 1
- 7 Connect to interconnect cable 1

3.6.3 Model ACS3120A(Single-Head)

CPU Unit

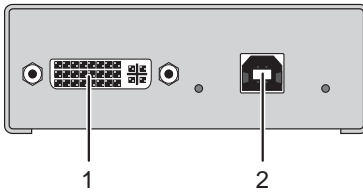

Front View

- 1 To CPU: DVI-D
- 2 To CPU: USB 2.0

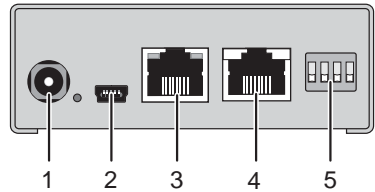

Rear View

- 1 Connect to 5VDC power supply
- 2 Service port
- 3 Connect to interconnect cable U
- 4 Connect to interconnect cable 1
- 5 Configuration DIP switches

CON Unit

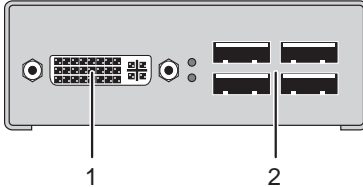

Front View

- 1 Connect to DVI monitor
- 2 Connect to USB 2.0 devices

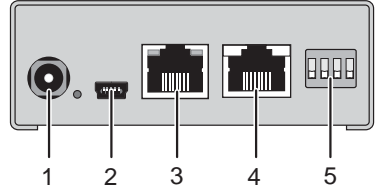

Rear View

- 1 Connect to 5VDC power supply
- 2 Service port
- 3 Connect to interconnect cable U
- 4 Connect to interconnect cable 1
- 5 Configuration DIP switches

3.6.4 Model ACS3220A(Dual-Head)

CPU Unit

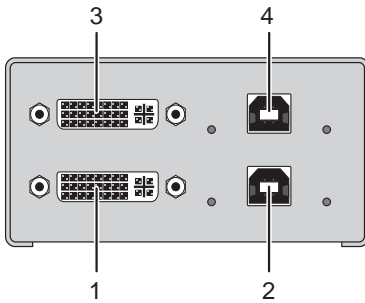

Front View

- 1 To CPU: DVI-D 1
- 2 To CPU: USB-HID
- 3 To CPU: DVI-D 2
- 4 To CPU: USB 2.0

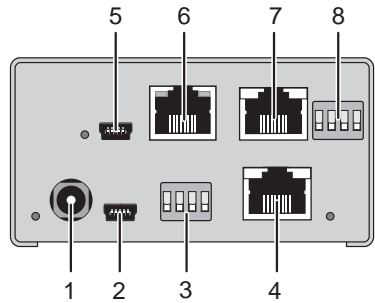

Rear View

- 1 Connect to 5VDC power supply
- 2 Service port 1
- 3 Configuration DIP switches 1
- 4 Connect to interconnect cable 1
- 5 Service port 2
- 6 Connect to interconnect cable U
- 7 Connect to interconnect cable 2
- 8 Configuration DIP switches 2

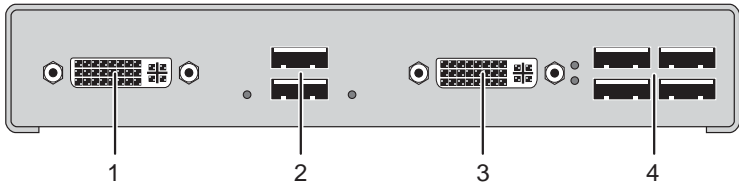
CON Unit*Front View*

- 1 Connect to DVI monitor 1
- 2 Connect to USB-HID devices 1
- 3 Connect to DVI monitor 2
- 4 Connect to USB 2.0 devices

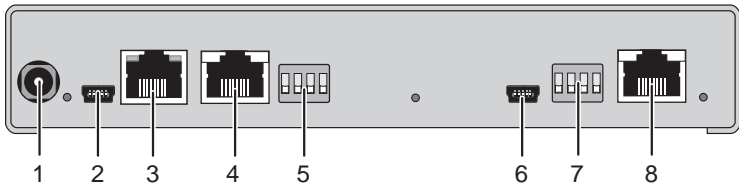
*Rear View*

- 1 Connect to 5VDC power supply
- 2 Service port 2
- 3 Connect to interconnect cable U
- 4 Connect to interconnect cable 2
- 5 Configuration DIP switches 2
- 6 Service port 1
- 7 Configuration DIP switches 1
- 8 Connect to interconnect cable 1

3.7 Diagnostics

The Extender is fitted with the following LEDs for status indication at CPU Unit and CON Unit:

Devices with USB-HID (CPU Unit and CON Unit)

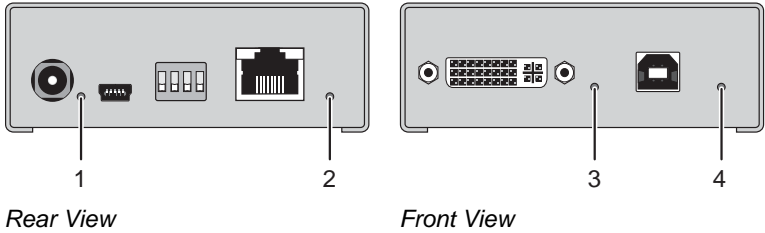

Pos.	LED	Status	Diagnostics
1	Power (red)	off	Device not ready
		on	Device ready
2	Link Status (green)	off	No connection via interconnect cable
		on	Connection available
3	Video OK (green)	off	<ul style="list-style-type: none"> CPU Unit: No DVI signal from video source (computer, CPU) detected CON Unit: No DVI signal from CPU Unit or no monitor detected
		on	DVI signal from video source available
		flashing	Monitor DDC is being transmitted from the console monitor
4	USB Status (green)	off	No USB connection
		on	USB connection available

Devices with USB 2.0 (CPU Unit and CON Unit)

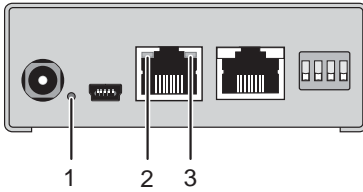

Rear View

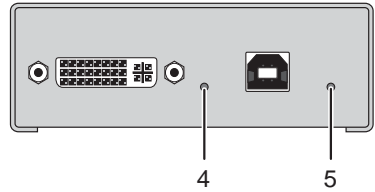

Front View

Pos.	LED	Status	Diagnostics
1	Power (red)	off	Device not ready
		on	Device ready
2	Link Status USB (green)	off	No connection via interconnect cable
		on	Connection available
		flashing	No USB host found
3	Link Status Video (green)	off	No connection via interconnect cable
		on	Connection via interconnect cable
4	Video OK (green)	off	<ul style="list-style-type: none"> CPU Unit: No DVI signal from video source (computer, CPU) detected CON Unit: No DVI signal from CPU Unit or no monitor detected
		on	DVI signal from video source available
		flashing	Monitor DDC is being transmitted from the console monitor
5	USB Status (green)	off	No USB connection
		on	USB connection available

4 Installation

4.1 Package Contents

You should receive the following items in your extender package:

- Extender pair (CPU Unit and CON Unit)
- 2x 5VDC international power supply unit
- 2x country specific power cord
- Quick Setup
- DVI video cable (1,8 m, DVI-D male-to-male)



- USB cable (1,8 m, USB type A to type B)



Additional content for Dual-Head devices:

- DVI video cable (1,8 m, DVI-D male-to-male)



- USB cable (1,8 m, USB type A to type B)



If anything is missing, contact your dealer.

4.2 System Setup



First time users are recommended to setup the system with the CPU Unit and the CON Unit in the same room as a test setup. This will allow you to identify and solve any cabling problems, and experiment with your system more conveniently.



→ Please verify that interconnect cables, interfaces, and handling of the devices comply with the requirements (see Chapter 7, Page 29).

1. Switch off all devices.

CON Unit Installation

2. Connect your monitor(s), keyboard and mouse to the CON Unit.
3. Connect the CON Unit with the interconnect cable(s).
4. Connect the 5VDC power supply to the CON Unit.

CPU Unit Installation

5. Connect the source (computer, CPU) with the supplied cables to the CPU Unit. Please ensure the cables are not strained.
6. Connect the CPU Unit to the interconnect cable(s).
7. Connect the 5VDC power supply to the CPU Unit.
8. Power up the system.



To power up the system, the following sequence is recommended:
Monitor – CON Unit – CPU Unit – source.

4.3 Example Applications

This section illustrates typical installations of Extenders (caption on following page):

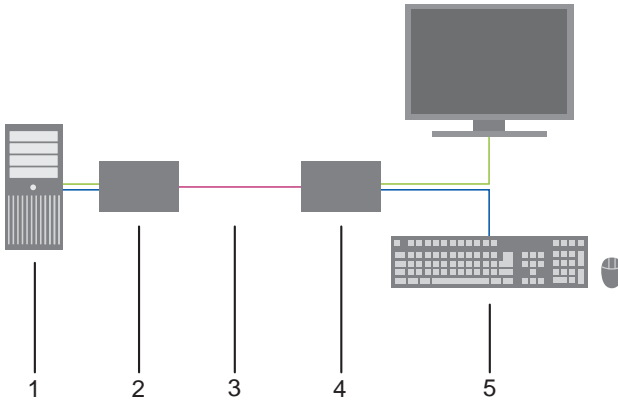

Extender (Single-Head)

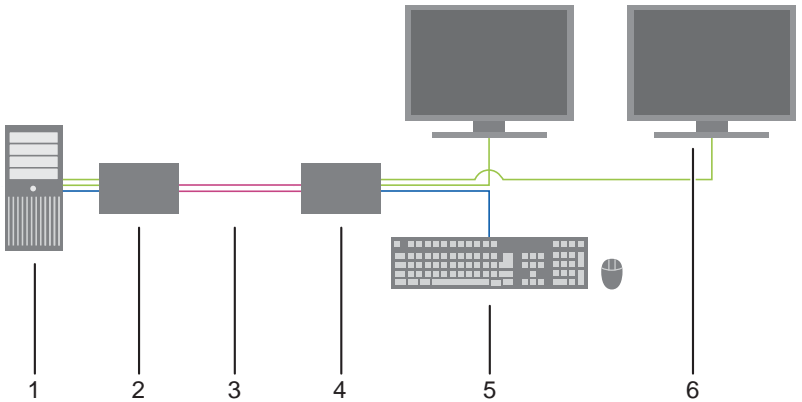

Extender (Dual-Head)

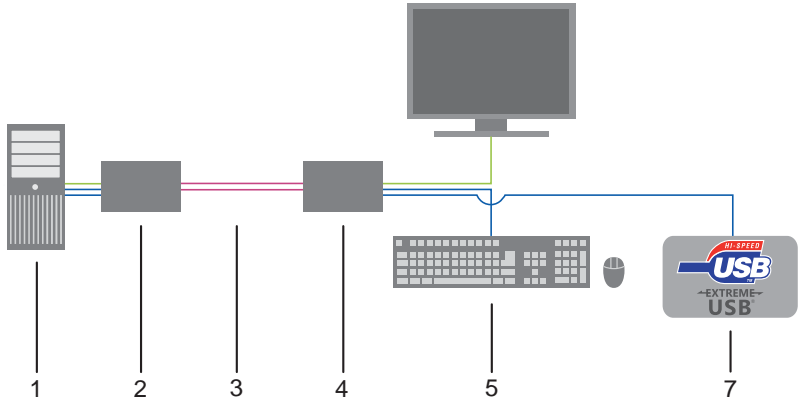

Extender (Single-Head with USB 2.0)

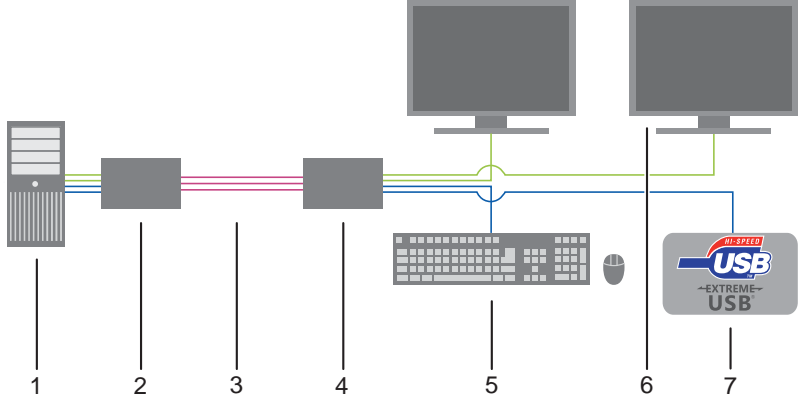

Extender (Dual-Head with USB 2.0)

- 1 Source (computer, CPU)
- 2 Extender CPU Unit
- 3 Interconnect cable
- 4 Extender CON Unit
- 5 Console (monitor, keyboard, mouse)
- 6 Second monitor (option, only with Dual-Head devices)
- 7 USB 2.0 devices (option, only with USB 2.0 devices)

5 Configuration

5.1 Transmission Parameters

By default, the device will automatically adapt to optimize video quality. This configuration is suitable for almost all conditions and should only be modified if video quality is not satisfactory.







In case of video interference, an automatic readjustment can be initiated by entering a keyboard command (see Chapter 6.1, Page 27). Please note that this feature is not available on model ACS3120A.

5.1.1 Adjustment of Video Resolution

The CPU Unit can be adjusted for the video resolution used with the following DIP switch settings:





CPU Unit

DIP	Function
Switch Position	<input type="checkbox"/> Switch down <input type="checkbox"/> Switch up <input type="checkbox"/> Not used
	Automatic adjustment (default)
	Resolution up to 1280x1024
	Resolution greater than 1280x1024
	Configuration for maximum distance transmission, independent of monitor resolution

5.1.2 Adjustment of Cable Length

The CON Unit can be adapted for the current interconnect cable length with the following DIP switch settings:

CON Unit

DIP	Function
Switch Position	<input type="checkbox"/> Switch down <input type="checkbox"/> Switch up <input type="checkbox"/> Not used
	Automatic adjustment (default)
	Cable length exceeds 10 m
	Cable length exceeds 20 m
	Maximum cable length: Use this setting if you are exceeding the maximum recommended cable length or if the video quality is not acceptable with automatic adjustment.



Cable lengths refer to Cat X solid-core cable type AWG24.

Using flexible stranded cables (patch cables) of type AWG26/8 is possible, however the maximum possible extension distance is halved.



➔ Change your DIP switch settings.

5.2 DDC Settings



By default, the device sends the factory preset DDC information to the CPU. This information is sufficient in most cases.

CPU Unit and CON Unit offer the following DIP switch settings to control the administration of the DDC information:

CPU Unit

DIP	Function
Switch Position	<input type="checkbox"/> Switch down <input type="checkbox"/> Switch up <input type="checkbox"/> Not used
	Send stored DDC information to CPU (default: factory preset DDC information). Allow reading of DDC information from the attached monitor.
	Reset and only ever send the factory default DDC information

CON Unit

DIP	Function
Switch Position	<input type="checkbox"/> Switch down <input type="checkbox"/> Switch up <input type="checkbox"/> Not used
	Prevent reading of DDC information from the attached monitor
	Allow reading of DDC information from the attached monitor

Reading of DDC information is performed during operation (see Chapter 6.2, Page 27).







If DIP switch **3** on the CPU Unit is in upper position the CPU will only ever be sent the factory preset DDC information.

5.3 Selection of Operation Mode

At CPU Unit and CON Unit you can select the operation mode with the following DIP switch settings:

CPU Unit and CON Unit

DIP	Function
Switch Position	 Switch down  Switch up  No used
	Standard operation (default)
	Test mode Devices before 2010: Update mode activated

During standard operation, DIP switch 4 must stay in the down position.

5.4 Command Mode

During normal use, the console keyboard functions in the usual manner. However, for all Extenders with USB-HID support, you can set the keyboard into a Command Mode by using a specific 'hot' key sequence. While in Command Mode, several functions are performed via keyboard commands. To exit Command Mode, press <Esc>.

While in Command Mode, the LEDs **Shift** and **Scroll** on the console keyboard will flash.



In Command Mode normal keyboard and mouse operation will cease. Only selected keyboard commands are available.

The following table lists the keyboard commands to enter and to exit Command Mode and to change the Hot Key sequence:

Function	Keyboard Command
Enter Command Mode (default)	2x <Left Shift> (Hot Key)
Exit Command Mode	<Esc>
Change Hot Key sequence	<Left Ctrl> + <Left Shift> + <c>, <Hot Key Code>, <Enter>

The Hot Key sequence to enter Command Mode can be changed. The following table lists the Hot Key Codes for the available key sequences (default: 3):

Hot Key Code	Hot Key Sequence
1	<Left Ctrl> + <Left Shift> + <i>
2	2x <Scroll>
3	2x <Left Shift>
4	2x <Left Ctrl>
5	2x <Left Alt>
6	2x <Right Shift>
7	2x <Right Ctrl>
8	2x <Right Alt>

6 Operation

6.1 Readjustment of Transmission Parameters (Auto-Adjust)

On Extenders with USB-HID support (not for model ACS3120A), the user can initiate an automatic readjustment of transmission parameters. The Extender will automatically optimize video quality.

1. Enter Command Mode (default: 2x <Left Shift>; see Chapter 5.4, Page 26).

2. Press the <a> key to start Auto-Adjust.

The screen will blank for a short time.

The Extender will exit Command Mode.

Transmission parameters have been readjusted. Video quality should be optimal.

6.2 Download of DDC Information

By default, the factory preset DDC information is sent to the source (computer, CPU). In some cases the factory preset DDC information may not be appropriate, so the option exits to read the actual DDC information from the attached monitor. The DIP switches have to be set correctly (see Chapter 5.2, Page 24).

There are two ways to read DDC information from the attached monitor:

- Via keyboard command during operation (see Chapter 6.2.1, Page 28).
- Reconnecting the monitor cable at the CON Unit (see Chapter 6.2.2, Page 28).

6.2.1 Download DDC via Keyboard Command

Use the following command sequence to read DDC information from the attached monitor (except for model ACS3120A).

1. Enter Command Mode (default: 2x <Left Shift>; see Chapter 5.4, Page 26).
2. Press the keys <2>, <Enter> to read the DDC information from the console monitor.

The screen will blank for a short time.

The Extender will exit Command Mode.

The CPU will now be able to read the actual monitor DDC information and so allow the required video resolution to be selected.

3. Enter Command Mode (default: 2x <Left Shift>).
4. Press the keys <1>, <Enter>.

The Extender will exit Command Mode.

The DDC information has been updated once. Further updates are only possible by repeating all the steps listed above or by re-attaching the monitor cable (see Chapter 6.2.2, Page 28).

6.2.2 Download DDC via DVI Cable

1. Move DIP switch **3** on the CON Unit to the upper position.
2. Please make sure that the monitor is on (**both** monitors in case of Dual-Head devices).
3. Disconnect the monitor cable from the CON Unit and connect the monitor cable again (In the case of Dual-Head devices, disconnect and connect monitor cables successively).

The DDC information will be read from the console monitor, transmitted to the CPU Unit and stored there internally.

To show successful reprogramming the LED **Video OK** flashes at both CON Unit and CPU Unit for about one second.

The CPU will now be able to read the actual monitor DDC information and so allow the required video resolution to be selected.

4. Move DIP switch **3** on the CON Unit to the down position.

Accidental download of DDC information can thus be avoided.

7 Specifications

7.1 Interfaces

7.1.1 DVI-D Single Link (Video source / monitor)

The video interface supports the DVI-D protocol. All signals that comply to DVI-D Single Link norm can be transmitted. This includes e.g. monitor resolutions such as 1920x1200@60Hz, Full HD (1080p) or 2K HD (up to 2048x1152). Data rate is limited to 165 MPixel/s.



Transmission of interlaced video signals, such as 1920x1080i, cannot be guaranteed.

7.1.2 USB-HID

Extender models with an USB-HID interface support a maximum of two devices compliant with the USB-HID protocol. Each USB-HID port provides a maximum current of 100 mA.

Keyboard

Compatible with most USB keyboards. Certain keyboards with additional functions may require custom firmware to operate. Keyboards with an integral USB Hub (Mac keyboards e.g.) are also supported.

Mouse

Compatible with most 2-button, 3-button and scroll mice.

Other USB-HID devices

The proprietary USB emulation also supports certain other USB-HID devices, such as specific touch screens, graphic tablets, barcode scanners or special keyboards. Support cannot be guaranteed, however, for every USB-HID device.



Only two USB-HID devices are supported concurrently, such as keyboard and mouse or keyboard and touch screen. A hub is allowed, but it does not increase the number of HID devices allowed.

To support other USB 'non-HID' devices, such as scanners, web cams or memory devices, choose a Extender model with transparent USB support.

7.1.3 USB 2.0 (transparent)

Extender models with transparent USB 2.0 support allow the connection of **all** types of USB 2.0 devices (without restriction). USB 2.0 data transfer is supported with USB high speed (max. 480 Mbit/s).

Each USB 2.0 port provides a maximum current of 500 mA (high power).

7.1.4 RJ45 (Interconnect)

The communication of the Cat X devices requires a 1000BASE-T connection.

Connector wiring must comply with EIA/TIA-568-B (1000BASE-T), with RJ45 connectors at both ends. All four cable wire pairs are used.

7.2 Interconnect Cable

7.2.1 Cat X



A point-to-point connection is required. Operation with several patch fields is possible. Routing over an active network component, such as an Ethernet Hub, Router or Switch, is not allowed.

- ➔ Avoid routing Cat X cables along power cables.
- ➔ If the site has 3-phase AC power, try to ensure that CPU Unit and CON Unit are on the same phase.



To maintain regulatory EMC compliance, correctly installed shielded Cat X cable must be used throughout the interconnection link.



To maintain regulatory EMC compliance, all Cat X cables need to carry ferrites on both cable ends close to the device.

Type of Interconnect Cable

The Extender requires interconnect cabling specified for Gigabit Ethernet (1000BASE-T). The use of solid-core (AWG24), shielded, Cat 5e (or better) is recommended.

Cat X Solid-Core Cable AWG24	S/UTP (Cat 5e) cable according to EIA/TIA-568-B. Four pairs of wires AWG24. Connection according to EIA/TIA-568-B (1000BASE-T).
Cat X Patch Cable AWG26/8	S/UTP (Cat 5e) cable according to EIA/TIA-568-B. Four pairs of wires AWG26/8. Connection according to EIA/TIA-568-B (1000BASE-T).



The use of flexible cables (patch cables) type AWG26/8 is possible, however the maximum possible extension distance is halved.

Maximum Acceptable Cable Length

Cat X Solid-Core Cable AWG24	40 m (120 ft) at 1920x1200 and 1600x1200 50 m (150 ft) at 1280x1024 and less
Cat X Patch Cable AWG26/8	20 m (60 ft) at 1920x1200 and 1600x1200 30 m (90 ft) at 1280x1024 and less



See Chapter 7.3.3, Page 33 for a list of specifically tested cables with an optimum range.

7.3 Supported Peripherals

7.3.1 USB-HID Devices

The Extender will support most USB-HID devices, including the vast majority of keyboards and mice currently on the market. Many other kinds of HID device such as bar-code scanners and touch screens may also be compatible

It is not possible to guarantee support for all available USB-HID devices. In certain cases, custom firmware may be required.

USB-HID (and other) devices that are not supported as standard will normally operate with Extender models featuring transparent USB support.



Please note that concurrent operation of more than two USB-HID devices is not possible even if you use a USB hub.

7.3.2 USB 2.0 Devices

Extender models featuring a transparent USB 2.0 connection use Extreme USB Technology from Icron Technologies.

This technology supports **all** types of USB 2.0 devices, however the manufacturer cannot guarantee compatibility with every device on the market. Please contact your dealer if any issues are found.

7.3.3 Interconnect Cable (Cat X)

Extenders should be used with cables as described in Chapter 7.2.1, Page 31.

Internal tests showed that certain cables or cable types allow longer cable lengths.

Enhanced performance is specified using the following cables:

Resolution (at 60 Hz)	Cable Type	Cable Length
1920x1200 and 1600x1200	Leoni Kerpen Megaline AWG24	>50 m (>150 ft)
1920x1200 and 1600x1200	Leoni Kerpen Megaline AWG23	>60 m (>180 ft)



The specified cables should be available through your dealer. Other cables on the market may support operation at extended distances but such operation cannot be guaranteed.

7.4 Connector Pinouts

Connector DVI-D Single-Link

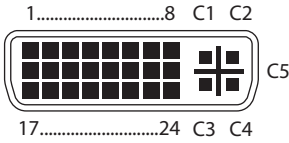

Pin	Signal	Pin	Signal	Pin	Signal
1	T.M.D.S data 2-	9	T.M.D.S data 1-	17	T.M.D.S data 0-
2	T.M.D.S data 2+	10	T.M.D.S data 1+	18	T.M.D.S data 0+
3	T.M.D.S data 2 GND	11	T.M.D.S data 1 GND	19	T.M.D.S data 0 GND
4	n.c.	12	n.c.	20	n.c.
5	n.c.	13	n.c.	21	n.c.
6	DDC Input (SCL)	14	+5VDC high impedance	22	T.M.D.S clock GND
7	DDC Output (SDA)	15	GND	23	T.M.D.S clock +
8	Internal use	16	Hot Plug recognition	24	T.M.D.S clock -
C1	Internal use			C3	Internal use
C2	n.c.	C5	GND	C4	Internal use

Connector USB Type B

Picture	Pin	Signal	Color
	1	VCC (+5VDC)	Red
	2	Data -	White
	3	Data +	Green
	4	GND	Black

Connector USB Type A

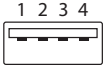
Picture	Pin	Signal	Color
	1	VCC (+5VDC)	Red
	2	Data –	White
	3	Data +	Green
	4	GND	Black

Connector Mini USB Type B

Picture	Pin	Signal	Color
	1	VCC (+5VDC)	Red
	2	Data –	White
	3	Data +	Green
	4	n.c.	–
	5	GND	Black

RJ45

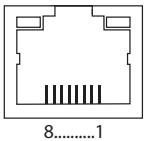
Picture	Pin	Signal	Pin	Signal
	1	D1+	5	D3–
	2	D1–	6	D2–
	3	D2+	7	D4+
	4	D3+	8	D4–

Power Supply

Picture	Pin	Signal
	Inside	VCC (+5VDC)
	Outside	GND

7.5 Power Supply

Single-Head Devices

Voltage	5VDC
Power Requirement	<ul style="list-style-type: none"> • ACS3110A(CPU Unit and CON Unit): 5VDC / 800 mA • ACS3120A(CPU Unit): 5VDC / 800 mA • ACS3120A(CON Unit): 5VDC / 2.500 mA

Dual-Head Devices

Voltage	5VDC
Power Requirement	<ul style="list-style-type: none"> • ACS3210A(CPU Unit and CON Unit): 5VDC / 1.600 mA • ACS3220A(CPU Unit): 5VDC / 1.600 mA • ACS3220A(CON Unit): 5VDC / 3.300 mA

7.6 Environmental Conditions

Operating Temperature	41 to 113°F (5 to 45°C)
Storage Temperature	-13 to 140°F (-25 to 60°C)
Relative Humidity	Max. 80% non-condensing

7.7 Size

Single-Head Devices

CPU Unit / CON Unit	80 x 110 x 29 mm (3.1" x 4.3" x 1.1")
Shipping Box	210 x 140 x 165 mm (8.3" x 5.5" x 6.5")

Dual-Head Devices

CPU Unit	80 x 110 x 42 mm (3.1" x 4.3" x 1.7")
CON Unit	161 x 110 x 29 mm (6.3" x 4.3" x 1.1")
Shipping Box	460 x 250 x 120 mm (18.1" x 9.8" x 4.7")

7.8 Shipping Weight

Single-Head Devices

CPU Unit / CON Unit	0,2 kg (0.4 lb)
Shipping Box	1,7 kg (3.8 lb)

Dual-Head Devices

CPU Unit / CON Unit	0,3 kg (0.7 lb)
Shipping Box	2,2 kg (4.9 lb)

8 Troubleshooting

8.1 Blank Screen

Diagnosis	Possible Reason	Measure
LED Power off	Power supply	→ Check power supply units and the connection to the mains.
LED Link Status off	Connection between CON Unit and CPU Unit	→ Check interconnect cable and connections.
CPU Unit: LED Video OK off	No video signal detected by source (computer, CPU)	→ Check DVI-D cable to CPU. → Download DDC information from console monitor (see Chapter 6.2, Page 27). Reboot CPU if necessary.
CON Unit: LED Video OK off	No monitor detected	→ Check connection, length and quality of the DVI-D cable to monitor, tighten cable thumbscrews.
	No video signal detected from CPU Unit	→ Check connection, length and quality of interconnect cable between the units. → Download DDC information from console monitors (see Chapter 6.2, Page 27). Reboot CPU if necessary.
	Suboptimal transmission parameters	→ Execute Auto-Adjust (see Chapter 6.1, Page 27). → If necessary, manually adjust parameters for monitor resolution (see Chapter 5.1.1, Page 22) and cable length (see Chapter 5.1.2, Page 23).

8.2 Video Jitter

Diagnosis	Possible Reason	Measure
Incorrect video display	Cable connection interrupted	<ul style="list-style-type: none"> ➔ Check connection, length and quality of DVI-D cable to CPU and to monitor, tighten cable thumbscrews. ➔ Check connection, length and quality of interconnect cables between the units.
	Suboptimal transmission parameters	<ul style="list-style-type: none"> ➔ Execute Auto-Adjust (see Chapter 6.1, Page 27). ➔ If necessary, manually adjust parameters for monitor resolution (see Chapter 5.1.1, Page 22) and cable length (see Chapter 5.1.2, Page 23).

8.3 USB-HID Failure

Diagnosis	Possible Reason	Measure
Keyboard LEDs Shift and Scroll are flashing	Keyboard in Command Mode	<ul style="list-style-type: none"> ➔ Press <Esc> to leave Command Mode.
CPU Unit: LED USB Status off	No USB connection to CPU	<ul style="list-style-type: none"> ➔ Check connection of USB cable to CPU, select another USB port if necessary. ➔ Remove USB and power cable and restart CPU. Connect power cable first.
CON Unit: LED USB Status off	Problems with USB connection	<ul style="list-style-type: none"> ➔ Check connection of USB cable to USB-HID device. ➔ Remove DVI and power cable and restart CON Unit. Connect power cable first.
USB device without function	No USB-HID device	<ul style="list-style-type: none"> ➔ Connect USB-HID device.
	USB-HID device is not supported	<ul style="list-style-type: none"> ➔ Contact dealer if necessary.

8.4 USB 2.0 Failure

Diagnosis	Possible Reason	Measure
LED Link Status USB off	Connection U between CON Unit and CPU Unit	➔ Check interconnect cable U and connections.
	USB controller (CON Unit)	➔ Check LED USB Status at CON Unit.
LED Link Status USB is flashing	Source (computer, CPU)	➔ Check status (standby, sleep mode).
	USB controller (CON Unit)	➔ Check LED USB Status at CON Unit.
CPU Unit: LED USB Status off	No USB connection to CPU	➔ Check connection of USB cable to CPU, select another USB port if necessary. ➔ Remove USB and power cable and restart CPU Unit. Connect power cable first.
CON Unit: LED USB Status off	Problem with USB connection	➔ Check connection of USB cable to USB-HID device. ➔ Remove DVI and power cables and restart CON Unit. Connect power cable first.
USB device without function	Device not detected by CPU	➔ Check installation including required drivers. ➔ Reconnect USB device. ➔ Contact dealer if necessary.

9 Technical Support

Prior to contacting support please ensure you have read this manual, and then installed and set-up your Extender as recommended.

9.1 Support Checklist

To efficiently handle your request it is necessary to complete our checklist for support and problem cases ([Download](#)). Keep the following information available before you call:

- Company, name, phone number and email
- Type and serial number of the device (see bottom of device)
- Date and number of sales receipt, name of dealer if necessary
- Issue date of the existing manual
- Nature, circumstances and duration of the problem
- Involved components (such as graphic source/CPU, OS, graphic card, monitor, USB-HID/USB 2.0 devices, interconnect cable) including manufacturer and model number
- Results from any testing you have done

9.2 Shipping Checklist

1. To return your device, contact your dealer to obtain a RMA number (Return-Material-Authorization).
2. Package your devices carefully, preferably using the original box. Add all pieces which you received originally.
3. Note your RMA number visibly on your shipment.



Devices that are sent in without a RMA number cannot be accepted. The shipment will be sent back without being opened, postage unpaid.

9.3 BlackBox subsidiary contact details

Country	Web Site	Phone / Fax	Email
Austria	www.black-box.at	+43 1 256 98 56 +43 +43 1 256 98 56 100	support@black-box.at
Belgium	www.blackbox.be	+32 2 725 85 50 +32 2 725 92 12	support.nederlands@blackbox.be support.french@blackbox.be support.english@blackbox.be
Denmark	www.blackbox.dk	+45 56 63 30 10 +45 56 65 08 05	blackbox@blackbox.dk
Finland	www.blackbox.fi	+35 201 888 800 +35 201 888 808	tuki@blackbox.fi
France	www.blackbox.fr	+33 1 45 606 717 +33 1 45 606 747	tech@blackbox.fr
Germany	www.black-box.de	+49 811 5541 110 +49 811 5541 499	techsupp@black-box.de
Ireland	www.blackbox.co.uk	+353 1 662 2466 +353 1 662 2477	techhelp@blackbox.co.uk
Italy (Milano)	www.blackbox.it	+39 02 27 404 700 +39 02 27 400 219	supporto.tecnico@blackbox.it
Italy (Roma)	www.blackbox.it	+39.06.57.50.350 +39.06.57.41.907	
Netherlands	www.blackbox.nl	+31 30 241 7799 +31 30 241 4746	techsupport@blackbox.nl
Norway	www.blackboxnorge.no	+47 55 300 710 +47 55 300 701	support@blackboxnorge.no
Spain	www.blackbox.es	+34 9162590732 +34 916239784	tecnico@blackbox.es
Sweden	www.blackboxab.se	+46 8 44 55 890 +46 08 38 04 30	support@blackboxab.se
Switzerland	www.black-box.ch	+41 55 451 70 71 +41 55 451 70 75	support@black-box.ch
United Kingdom	www.blackbox.co.uk	+44 118 965 6000 +44 118 965 6001	techhelp@blackbox.co.uk
United States	www.blackbox.com	+1 724-746-5500 +1 724-746-0746	

9.4 CE Declaration Of Conformity

The products listed below in the form as delivered comply with the provisions of the following European Directives:

2004/108/EG Council Directive on the approximation of the laws of the Member States relating to electromagnetic compatibility



CE Marking 2009

Product list:

ACS3310A, ACS3210A, ACS3120A, ACS3220A

The products comply with the following harmonized standards for Information Technology Equipment:

EN 55022:	09/2006 (Class A)
IEC 61000-4-2:	02/2001
IEC 61000-4-3:	05/2006
IEC 61000-4-4:	12/2004
IEC 61000-4-5:	11/2006

This declaration certifies the conformity to the specified directives but contains no assurance of properties. The safety instructions and installation guidelines noted in this manual shall be considered in detail. The length of the attached CPU or CON cables must not exceed 3 m. The use of suggested interconnect cables is mandatory.



Use in a Domestic Environment

This is a Class A product. In a domestic environment, this product may cause radio interference in which case the user may be required to take adequate measures.

9.5 North American Regulatory Compliance

This equipment has been found to comply with the limits for a Class A digital device, pursuant to Part 15 of the FCC Rules. These limits are designed to provide reasonable protection against harmful interference when the equipment is operated in a commercial environment. This equipment generates, uses, and can radiate radio frequency energy and, if not installed and used in accordance with the instruction manual, may cause harmful interference to radio communications. Operation of this equipment in a residential area is likely to cause harmful interference in which case the user will be required to correct the interference at his own expense.

Changes or modifications not expressly approved by the party responsible for compliance could void the user's authority to operate the equipment.

Shielded cables must be used with this equipment to maintain compliance with radio frequency energy emission regulations and ensure a suitably high level of immunity to electromagnetic disturbances.

All power supplies are certified to the relevant major international safety standards.

9.6 WEEE

The manufacturer complies with the EC Directive 2002/96/EG on the prevention of waste electrical and electronic equipment (WEEE).

The device labels carry a respective marking.

9.7 RoHS

This device complies with the EC Directive 2002/95/EG on the Restriction of the use of certain Hazardous Substances in electrical and electronic equipment (RoHS).

The device labels carry a respective marking.

10 Glossary

The following terms are commonly used in this guide or in video and KVM technology:

Term	Explanation
Cat X	Any Cat 5e (Cat 6, Cat 7) cable
CON Unit	Component of a Extender or Media Extender to connect to the console (monitor(s), keyboard and mouse; optionally also with USB 2.0 devices)
CPU Unit	Component of a Extender or Media Extender to connect to a source (computer, CPU)
DDC	The Display Data Channel (DDC) is a serial communication interface between monitor and source (computer, CPU), which allows a data exchange via monitor cable and an automatic installation and configuration of a monitor driver by the operating system.
Dual Access	A system to operate a source (computer, CPU) from two consoles
Dual-Head	A system with two video connections
Dual Link	A DVI-D interface for resolutions up to 2560x2048 by transmission of 6x up to 165 MPixel/s (24-bit) of color information
DVI	Digital video standard, introduced by the Digital Display Working Group (http://www.ddwg.org). Single Link and Dual Link standard are distinguished. The signals have TMDS level.
Fiber	Single-mode or multi-mode fiber cables
Console	Keyboard, mouse and monitor
KVM	Keyboard, video and mouse
Multi-mode	62.5 μ multi-mode fiber cable or 50 μ multi-mode fiber cable
Quad-Head	A system with four video connections
SFP	SFPs (small form factor pluggable) are pluggable interface modules for Gigabit connections. SFP modules are available for Cat X and fiber interconnect cables.
Single-Head	A system with one video connection

CATx DVI-D plus USB HID Extender

Term	Explanation
Single Link	A DVI-D interface for resolutions up to 1920x1200 by transmission of 3x up to 165 MPixel/s (24-bit) of color information. Alternative frequencies are Full HD (1080p), 2K HD and accordingly 2048x1152.
Single-mode	9μ single-mode fiber cable
Triple-Head	A system with three video connections
USB-HID	USB-HID devices (Human Interface Device) allow for data input. There is no need for a special driver during installation; "New USB-HID device found" is reported. Typical HID devices include keyboards, mice, graphics tablets and touch screens. Storage, video and audio devices are not HID.