

T1 Fiber Optic Line Extender/Simulator

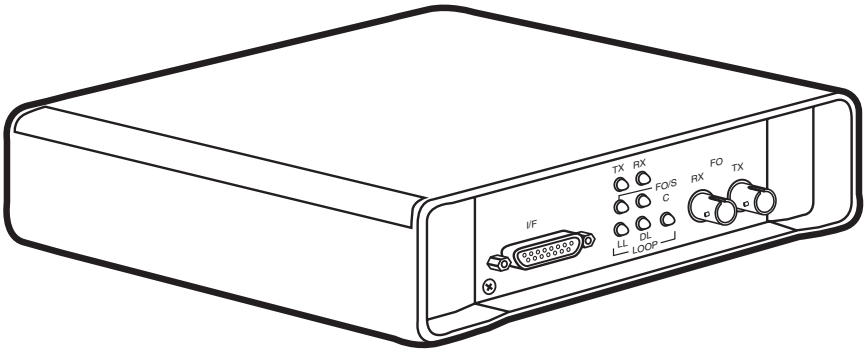

**CUSTOMER
SUPPORT
INFORMATION**

Order **toll-free** in the U.S. 24 hours, 7 A.M. Monday to midnight Friday: **877-877-BBOX**
FREE technical support, 24 hours a day, 7 days a week: Call **724-746-5500** or fax **724-746-0746**
Mail order: **Black Box Corporation**, 1000 Park Drive, Lawrence, PA 15055-1018
Web site: www.blackbox.com • E-mail: info@blackbox.com

**FEDERAL COMMUNICATIONS COMMISSION
AND
INDUSTRY CANADA
RADIO FREQUENCY INTERFERENCE STATEMENTS**

This equipment generates, uses, and can radiate radio frequency energy and if not installed and used properly, that is, in strict accordance with the manufacturer's instructions, may cause interference to radio communication. It has been tested and found to comply with the limits for a Class A computing device in accordance with the specifications in Subpart J of Part 15 of FCC rules, which are designed to provide reasonable protection against such interference when the equipment is operated in a commercial environment. Operation of this equipment in a residential area is likely to cause interference, in which case the user at his own expense will be required to take whatever measures may be necessary to correct the interference.

Changes or modifications not expressly approved by the party responsible for compliance could void the user's authority to operate the equipment.

This digital apparatus does not exceed the Class A limits for radio noise emission from digital apparatus set out in the Radio Interference Regulation of Industry Canada.

Le présent appareil numérique n'émet pas de bruits radioélectriques dépassant les limites applicables aux appareils numériques de la classe A prescrites dans le Règlement sur le brouillage radioélectrique publié par Industrie Canada.

NORMAS OFICIALES MEXICANAS (NOM) ELECTRICAL SAFETY STATEMENT

INSTRUCCIONES DE SEGURIDAD

1. Todas las instrucciones de seguridad y operación deberán ser leídas antes de que el aparato eléctrico sea operado.
2. Las instrucciones de seguridad y operación deberán ser guardadas para referencia futura.
3. Todas las advertencias en el aparato eléctrico y en sus instrucciones de operación deben ser respetadas.
4. Todas las instrucciones de operación y uso deben ser seguidas.
5. El aparato eléctrico no deberá ser usado cerca del agua—por ejemplo, cerca de la tina de baño, lavabo, sótano mojado o cerca de una alberca, etc..
6. El aparato eléctrico debe ser usado únicamente con carritos o pedestales que sean recomendados por el fabricante.
7. El aparato eléctrico debe ser montado a la pared o al techo sólo como sea recomendado por el fabricante.
8. Servicio—El usuario no debe intentar dar servicio al equipo eléctrico más allá a lo descrito en las instrucciones de operación. Todo otro servicio deberá ser referido a personal de servicio calificado.
9. El aparato eléctrico debe ser situado de tal manera que su posición no interfiera su uso. La colocación del aparato eléctrico sobre una cama, sofá, alfombra o superficie similar puede bloquea la ventilación, no se debe colocar en libreros o gabinetes que impidan el flujo de aire por los orificios de ventilación.
10. El equipo eléctrico deber ser situado fuera del alcance de fuentes de calor como radiadores, registros de calor, estufas u otros aparatos (incluyendo amplificadores) que producen calor.
11. El aparato eléctrico deberá ser conectado a una fuente de poder sólo del tipo descrito en el instructivo de operación, o como se indique en el aparato.

12. Precaución debe ser tomada de tal manera que la tierra física y la polarización del equipo no sea eliminada.
13. Los cables de la fuente de poder deben ser guiados de tal manera que no sean pisados ni pellizcados por objetos colocados sobre o contra ellos, poniendo particular atención a los contactos y receptáculos donde salen del aparato.
14. El equipo eléctrico debe ser limpiado únicamente de acuerdo a las recomendaciones del fabricante.
15. En caso de existir, una antena externa deberá ser localizada lejos de las líneas de energía.
16. El cable de corriente deberá ser desconectado del cuando el equipo no sea usado por un largo periodo de tiempo.
17. Cuidado debe ser tomado de tal manera que objetos líquidos no sean derramados sobre la cubierta u orificios de ventilación.
18. Servicio por personal calificado deberá ser provisto cuando:
 - A: El cable de poder o el contacto ha sido dañado; u
 - B: Objetos han caído o líquido ha sido derramado dentro del aparato; o
 - C: El aparato ha sido expuesto a la lluvia; o
 - D: El aparato parece no operar normalmente o muestra un cambio en su desempeño; o
 - E: El aparato ha sido tirado o su cubierta ha sido dañada.

General Safety Precautions

Transport, Installation, and Operation

- Avoid excessive vibration and shocks.
- Avoid contact with water and dust.
- Avoid excessive direct sunlight.
- Ensure sufficient cooling.
- Prevent loose items from falling into the device.

Fiber Optics

- Looking into the fiber optic output can cause injury to the eyes. When observation is necessary, avoid exceeding the limits recommended in ANSI Z136.1-1981.

Mains Power

- Disconnect the power cord before opening the device.
- Use exclusively the included power supply with an approved power cord.
- The power plug must be plugged into a properly grounded receptacle. An improperly wired receptacle could place hazardous voltage on accessible metal parts of the device.
- The mains supply must match the Simulator's power specification.
- Replace blown fuses with fuses of the exact type and rating.
- Do not work on the equipment during periods of lightning activity.

TRADEMARKS USED IN THIS MANUAL

ST[®] is a registered trademark of American Telephone and Telegraph Company.

Any trademarks mentioned in this manual are acknowledged to be the property of the trademark owners.

Contents

- 1. Specifications 7
- 2. Introduction 8
 - 2.1 Description 8
 - 2.2 Features 8
 - 2.3 Typical Application 8
- 3. Connectors, Indicators, and Controls 9
- 4. Setup 10
- 5. Data Signals 14
- Appendix: Fiber Optic Planning Guidelines 16
 - A.1 Introduction 16
 - A.2 Fiber Optic Calculation 17
 - A.3 Operation Diagram 20

1. Specifications

Maximum Distance—39004: 3 mi. (4.8 km) @ 16 dB; 39005: 24 mi. (38.6 km) @ 16 dB

Speed—1.544 Mbps

Interface—DTE: T1, G.703/DS1; Fiber: Dual ST® multimode or single-mode

Connectors—DB15 for DTE, dual ST for fiber

Indicators and Buttons—(6) LEDs: TX, RX, FO/S, C, LL, DL; (1) Loop mode button

Optical*—Standard: 1300-nm SM LED; Pulse width: 648 ns; Transmitter output power: -13 or -18 dBm**; Pairs optical power budget: 9/125 μ m, 18 dB; Receiver operation range: -15 through -31 dBm

G.703—Transmit level: 15.7 dBm; Maximum attenuation: 6 dB; Line impedance: 100 or 120 Ω **

Temperature Tolerance—Operating: 41 to 104°F (5 to 40°C); Storage: -22 to +176°F (-30 to +80°C)

Humidity—10 to 90% noncondensing

Power—115-VAC external power supply, 60 Hz, 12 W

Size—1.5"H x 5.8"W x 8.8"D (3.8 x 14.7 x 22.4 cm)

Weight—3.3 lb. (1.5 kg)

*Optical specifications are valid at 77°F (25°C).

**Depends on setup.

2. Introduction

2.1 Description

The T1 Fiber Optic Line Extender/Simulator lets you combine fiber optic technology with standard interfaces at 1.544 Mbps. The advantages are increased transmission distances and immunity to electrical interference. Connections between buildings become possible since no lightning currents can arise.

2.2 Features

- Extend or interconnect T1 lines, PBXs, or T1 muxes across distances up to 3 miles (4.8 km) via a pair of these devices.
- For line simulation, the device is transparent to equipment, framing, and encoding—PBXs and multiplexors act like they're directly connected to a T1 circuit.
- EMI/RFI and lightning-hazard immunity is provided by the fiber link.

2.3 Typical Application

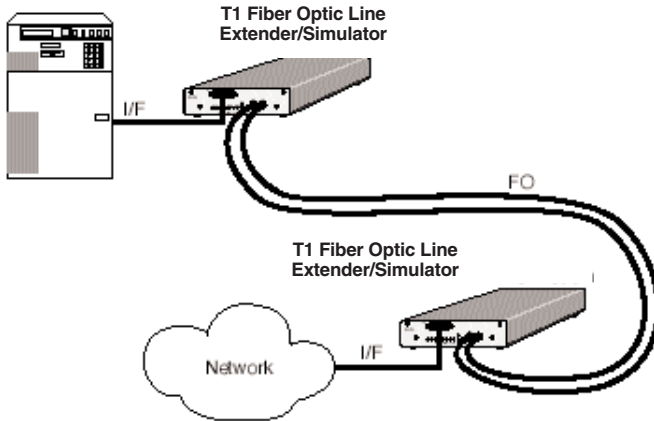

3. Connectors, Indicators, and Controls

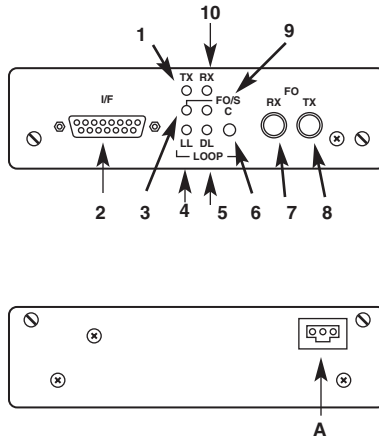

Figure 3-1. Front and Rear Panels.

Table 3-1. Connectors, Indicators, and Controls

No.	Connector, Indicator, or Control
1	TX LED: Transmitting binary 0 via fiber optic
2	G.703 connector
3	FO/S LED: Power/FO Link/sync
4	LL LED: Unit in line loop mode*
5	DL LED: Unit in digital loop mode*
6	Loop mode button
7	ST connector for fiber optic receiver
8	ST connector for fiber optic transmitter
9	C LED: G.703 signal present
10	RX LED: Receiving binary 0 via fiber optic
A	Power connector

*Both LEDs lit: Unit is in remote loop mode.

4. Setup

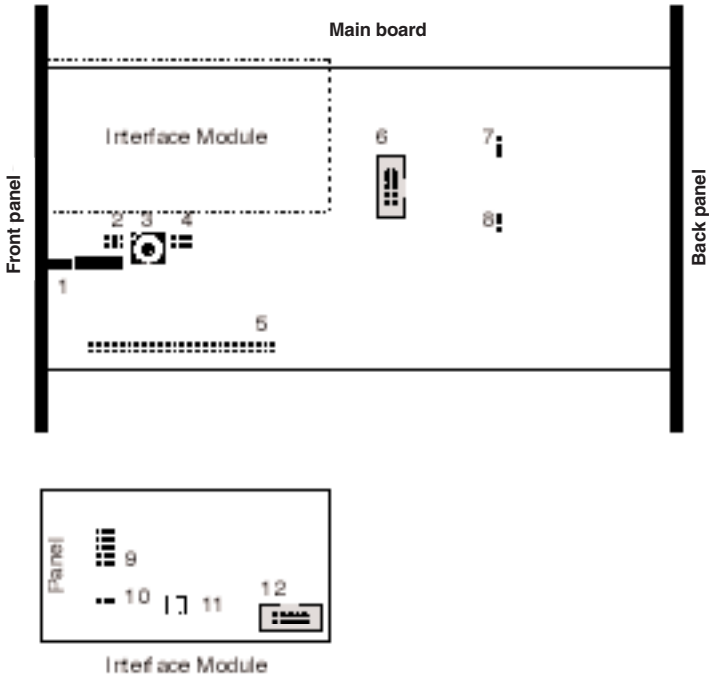

Figure 4-1. Location of Jumpers on the Printed Circuit Board.

Table 4-1. Key, Jumper, and Switch Settings



Number	Setting	Description
1		<p>Loop Mode Key: Press the key switches through the following operating modes: Normal operation, Digital loop, Remote loop. The unit enters loop mode when the distant modem gets switched to remote loop.</p>
2		<p>Clock Source Internal Remote External</p>
3	<p>Position D</p>	<p>Interface Speed 1.544 kbps 1544 All other settings are not applicable.</p>
4		
5		<p>Processor Connector Not used. Do not install any jumpers!</p>
6		<p>For factory use only. Do not install any jumpers!</p>
7	<p>Low High</p>	<p>Fiber Optic Output Power</p>

Table 4-1 (continued). Key, Jumper, and Switch Settings

Number	Setting	Description
8	Sample mode for incoming intermediate frequency (I/F) data <ul style="list-style-type: none"> ! Data sampled on positive clock edge (std.) ! Data sampled on negative clock edge 	
9	Interface Mode <ul style="list-style-type: none"> NT (Network Termination) TE (Terminal Equipment) 	
10	Interface Pin 1 Potential <ul style="list-style-type: none"> - Floating - Connected to frame ground 	
11	Transmission Mode Switch setting is mandatory. Switches 1, 2, and 4 must be in OFF position. Switch 3 must be in ON position.	
12	Test connector. Do not install any jumpers!	

Table 4-2. Fiber Optic Signal (FO/S) LED

FO/S LED	Meaning
Off	No power supplied.
Slow Flash (1.5/s)	No fiber optic link established.
Fast flash (5/s)	Fiber optic link OK but no clock sync.
On	Fiber optic link OK and clock sync OK.

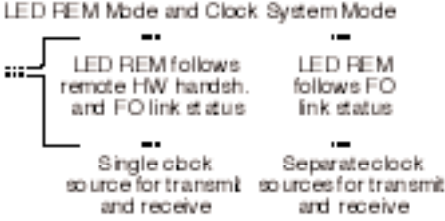
Clock Mode Comments:

- Internal: The clock is generated by the internal clock generator.
- External: The clock is provided by the local equipment.
- Remote: The local modem receives the clock via the link from the distant modem. The distant modem must be set to Internal or External.

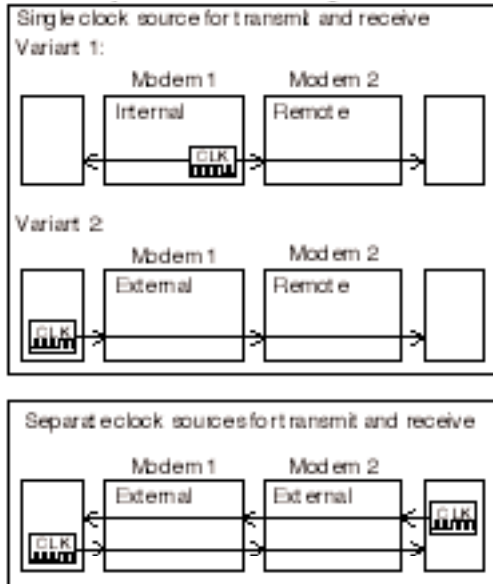

Figure 4-2. Possible Synchronous Clock Configurations.

5. Data Signals

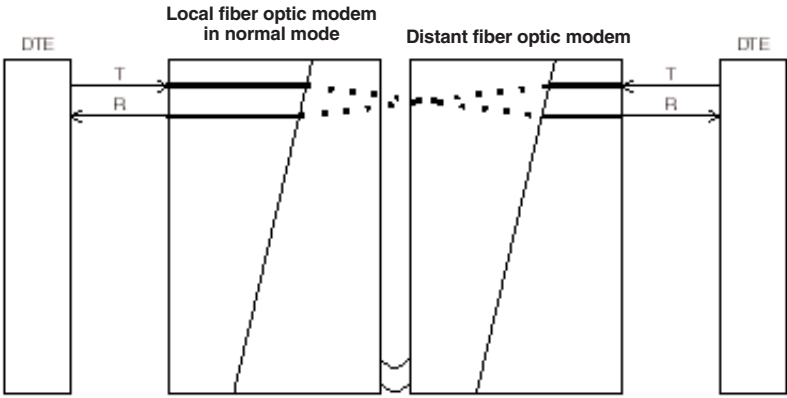

Figure 5-1. Data Signals at Normal Mode.

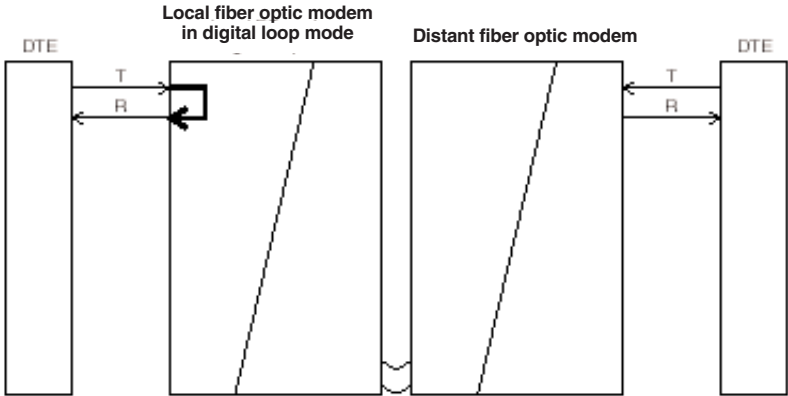

Figure 5-2. Data Signals at Digital Loop Mode.

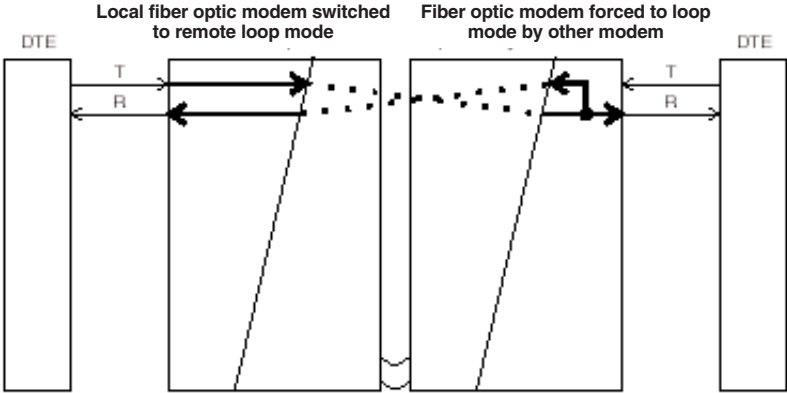

Figure 5-3. Data Signals at Remote Loop/Line Loop Mode.

Table 5-1. G.703 Pinout (Female)

Pin	Signal	Terminal End	Network Termination
2	R A	Input	Output
4	T A	Output	Input
9	R B	Input	Output
11	T B	Output	Input

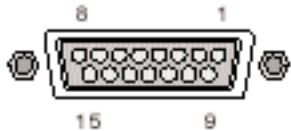

Figure 5-4. G.703 Connector.

Appendix: Fiber Optic Planning Guidelines

A.1 Introduction

Designing a fiber optic link means considering two main physical limitations: System attenuation and fiber optic dispersion.

Attenuation results when properties of the fiber optic link reduce the intensity of the fiber optic signals. Dispersion occurs in high-speed links and causes degradation of fiber optic signals, disabling the receiver that would interpret them correctly.

The analysis of the planned fiber optic link is a two-step process. First, you must calculate the attenuation of the complete system to ensure that the units can cope with the losses of the link. Then, you must enter the intended distance between the units into the operation diagram (see **Figure A-2**). (Make sure the distance is confirmed by the calculation above.) These calculations are explained in **Section A.2**.

When you calculate the maximum range, keep in mind that extremely short cabling can be problematic, too. Avoid receiver overload conditions for proper data transmission.

For wavelength/multiplexing (WDM) equipped units, you must perform the calculations for each wavelength independently (twice total). You must operate the WDM-equipped counterparts within the restrictions defined by both resulting operation diagrams.

Please observe that the optical power budget stated in the documentation of a WDM-equipped unit is valid for the transmitted wavelength only. The optical power budget for the received wavelength can be found in the documentation of the counterpart unit.

A.2 Fiber Optic Calculation

STEP 1: ATTENUATION CONSIDERATIONS

Figure A-1 shows the various elements of the fiber optic link that decrease light intensity. Depending on the real installation, you must subtract a series of attenuation (att.) values from the raw optic output level of the fiber optic transmitter. The remainder of the originally transmitted light at the receiver must be at least as high as the minimum receiver sensitivity. Generally, you should project a link margin of at least 3 dB to allow aging and fiber repairs.

Use the formulas described below to calculate the attenuation values for your system:

- (optical power budget)=(max. of transmitter output power) - (min. of receiver operation range) The stated optical power budget does not include irregular light propagation modes. At short distances, these modes increase the optical power at the receiver. The increase depends mainly on fiber optic mode and cable quality. Consider the irregular light propagation modes at multimode only and add about 3 dB. This amount is included in the stated multimode transmitter output values.
- (total system att.)=sum of all discrete attenuations (as shown in Figure A-1). This value is the attenuation of the link due to the link components.
- (cable length)=(cable attenuation)/(cable att. factor). This formula is used to calculate cable length or resulting attenuation. The cable att. factor is provided by the cable producer.

Example values for calculations below (See Figure A-1):

Fiber optic power budget of the combination unit [1]/unit [7]=17 dB. Cable att. factor of cables [2], [4], and [6]=3 dB/km. Cable [4]=1 km. Cable [6]=2 km. Splice [5] loss 1 dB.

Connector loss at patch panel [3]=2 dB.

Example 1: Maximum length of cable [2]:

(cable [4] att.)= 1 km*3 dB/km=3 dB (cable [6] att.)=2 km*3 dB/km=6 dB.

(right part att.)=(Conn. loss [3]) + (cable [4] att.) + (splice [5] loss) + (cable [6] att.)

(right part att.)= 2 dB + 3 dB + 1 dB +6 dB=12 dB.

T1 FIBER OPTIC LINE EXTENDER/SIMULATOR

(max. cable [2] att.)=(fiber optic power budget) - (right part att.) = 17 dB - 12 dB = 5 dB.

(max. cable [2] length) = (max.cable [2] att.)/(cable [2] att. factor) = 5 dB/3 dB/km = 5.6 km

Example 2: Maximum length of cable [2] when connected directly (without splices, etc.): (max. cable [2] length) = (fiber optic power budget)/(cable [2] att. factor) = 17 dB/3 dB/km = 5.6 km

Example 3: Minimum cable quality to bridge 5 km (single cable without splices or patches): (cable att. factor) = (cable att.)/(cable length) = 17 dB (fiber optic power budget)/5 km = 3.4 dB/km

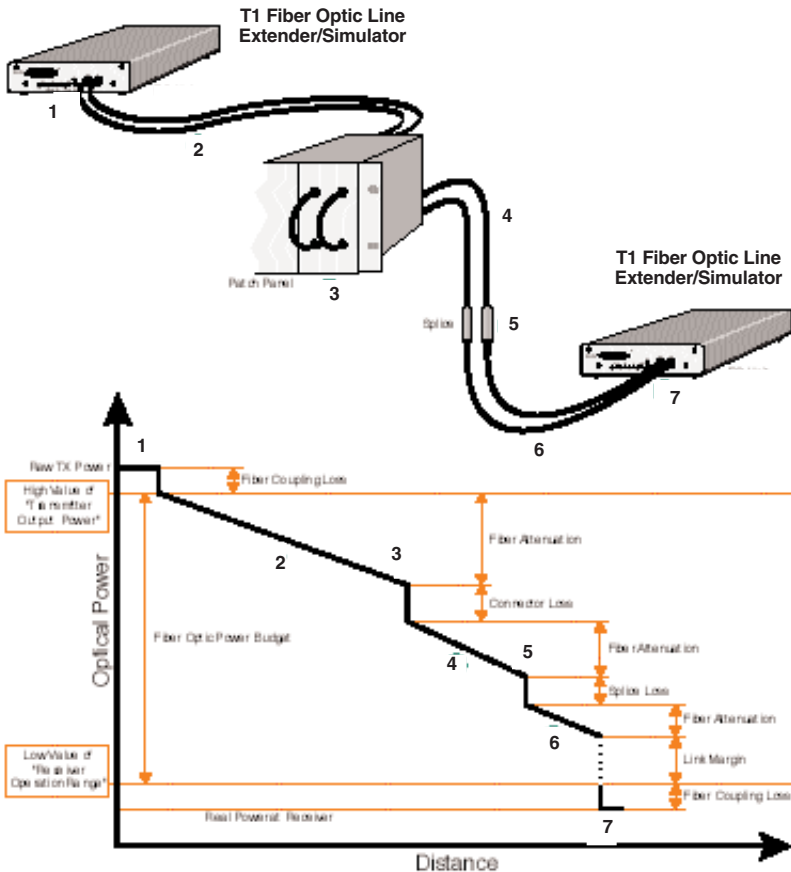

Figure A-1. Attenuation diagram.

STEP 2: OVERALL OPERATION CONSIDERATIONS

The operation diagram (**Figure A-2**) shows one example diagram and one blank diagram to be completed based on real values:

1. Draw horizontal lines at the min. and max. value of the fiber optic pulse width* of the affected units.
2. Calculate the maximum total distance based on the calculations above and draw a vertical line.
3. Choose the correct dispersion line** based on fiber optic transmitter type*.
4. Shade the allowed operation range as shown in **Figure A-2**.

*To be found in the technical data section of the units' documentation.

**Industry-standard cable quality assumed: 18 ps/(nm*km) @ 1550 nm.

A.3 Operation Diagram

Example: Physical operation restrictions for a unit with 1550-nm standard laser, a fiber optic pulse width between 10 and 100 ns and a calculated maximum distance between the units of 60 km.

The operation you choose must be inside the allowed (shaded) area.

NOTE

The right border of the operation area is defined by the dispersion or distance line, whichever comes first (leftmost). Some units use only one discrete fiber optic pulse width. In this case, the allowed operation area collapses to a horizontal line. If there is no dispersion line for the used fiber optic transmitter type, dispersion can be ignored.

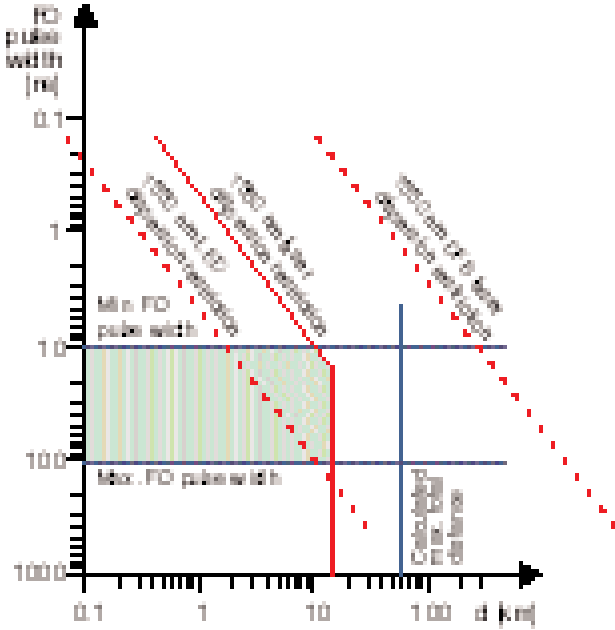

Figure A-2. Operation Diagram

Use the example on the previous page as a reference when filling in information for your application below.

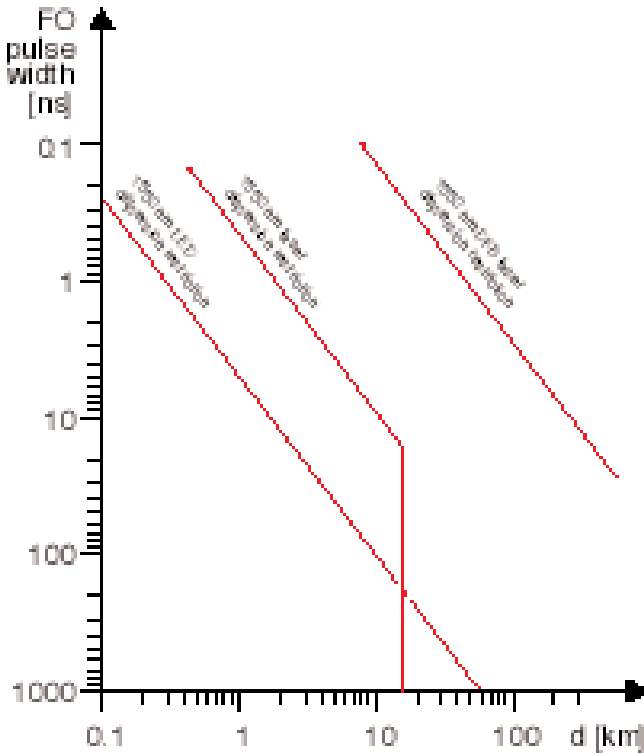

Figure A-3. Your Application.



© Copyright 2000. Black Box Corporation. All rights reserved.

1000 Park Drive • Lawrence, PA 15055-1018 • 724-746-5500 • Fax 724-746-0746